

# VARIO2<sup>iP</sup> PoE HYBRID

## Quick Setup Instructions Vario2 IPPOE Hybrid Series

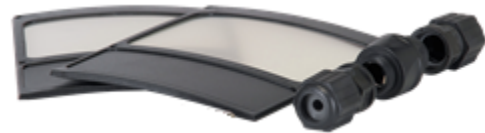

Installation by suitably trained and  
qualified personnel only  
Suitable for Internal and External  
Applications

### Box Contents:

VARIO2 IPPOE Hybrid Illuminator - Infra-Red (IR) & White-Light (WL)  
35° x 10° beam angle IHD ; 60° x 25° beam angle IHD  
Waterproof RJ45 connector

### Accessories (optional):

80° x 30° beam angle IHD  
120° x 50° beam angle IHD

System requirements: A PC running Windows with  
network access running a modern web browser (Chrome, Firefox).

Full detailed instructions available from the Raytec website

Rev 2.0.0

## Safety Information

Install in a well-ventilated area.



### Eye Safety : IR Light (850nm and 940nm)

Caution – IR emitted from this product EN62471 Risk Group 2. Do not stare at the lamp. Avoid exposure or use appropriate shielding / eye protection. Risk Group 2 for cornea / lens infrared hazard. Hazard distance is 2000mm.

### Eye Safety : White Light ; 730nm

Caution – EN62471 Risk Group 2 Classification - Possible hazardous optical radiation emitted from this product. May be harmful to eyes, do not stare at the lamp. Hazard distance is 1500mm.

### Eye Safety : EHV (Exposure Hazard value)

69.2% of RG2 limit at 200mm from the lamp

**Eye Safety : Other Wavelengths** – Contact Raytec

**The Illuminator is Class III for Insulation**  
Illuminators are suitable for use Outdoors and Indoors

## Product Introduction

Vario2 IPPOE Hybrid is a Network Illuminator that uses the latest in Infra-Red and White Light LED technology in the same illuminator package. The Vario2 IPPOE Hybrid is designed to connect to a suitable network and is provided with an integrated Web Interface.

The Raytec Discovery Tool allows for easy identification and connection to the illuminator or you can connect directly to the illuminator via its IP address.

The illuminator has a CAT 5 cable for data connection, can be powered from PoE, and is supplied with a waterproof CAT 5 connector. The illuminator also has an auxiliary cable if low voltage 24V DC operation is preferred.

The Vario2 IPPOE Hybrid comes with a number of features that allow the user to change between the two wavelengths.

The illuminator has a photocell for automatic day/night switching and has an External Input (to act as a telemetry, trigger input, volt free or TTL) and an External Output (volt free output). It also benefits from Raytecs interchangeable lens system so that the correct angle of illumination can always be achieved easily.

The illuminator has Operator and Administrator log-in and access rights. The Operator has access to the Homepage and Diagnostic pages. The Administrator has access to all pages.

An API is available for programmers for integration within a VMS / BMS environment. The illuminator also has a HTTP API to control the illuminator via HTTP commands.

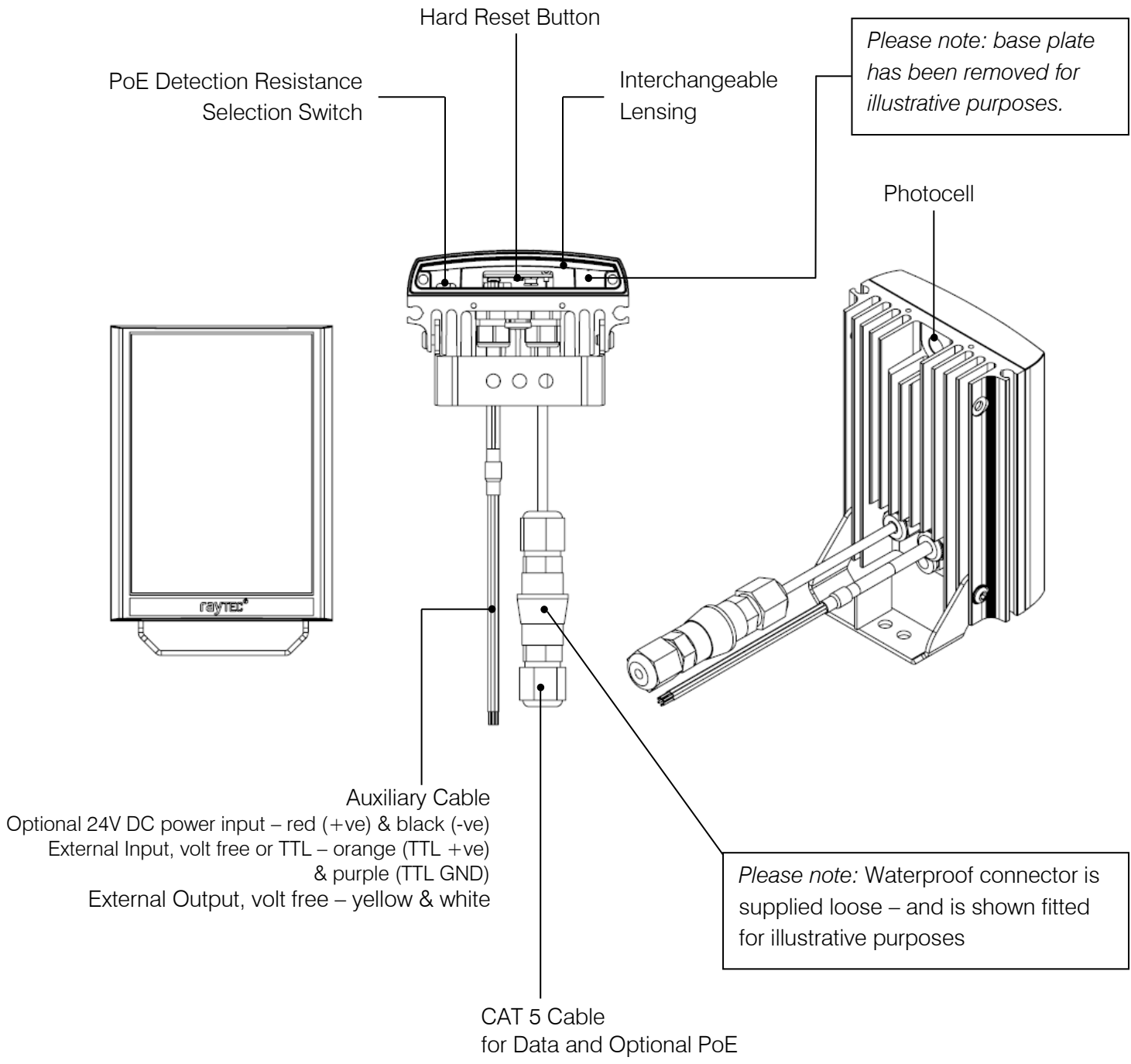

# Basic Steps

(Quick Installation Guide P1-19/ Detailed Guide – see Raytec website)

## **STEP 1:** Safety Information (Pg. 2)

## **STEP 2:** Wiring (Pg. 7)

For PoE, use standard CAT 5 or better for both power and data. For all 8 sized products, check the PoE detection resistance of the illuminator is compatible with your PoE equipment (24.9K $\Omega$  class 6 is factory default).

For low voltage (non-PoE) apply 24V DC to red and black cores of auxiliary cable and use standard CAT 5 or better for data connection. Connect external inputs and external output wires as required.

### **IMPORTANT:**

To choose between Infra-Red and White Light configure using the GUI interface

Default is IR for P/cell senses darkness and WL for Ext. Input if active when P/Cell senses darkness.

Ensure PoE equipment or 24V PSU are suitably rated

For 8 sized products check PoE detection resistance is set correctly

Ensure Cat 5 cable and auxiliary cable are correctly terminated and waterproofed after installation

If using low voltage, a CAT 5 cable must still be connected to the network for communication

If not using auxiliary cable, it must still be suitably terminated and waterproofed

## **STEP 3:** Physical Installation (Pg. 9-10)

Adjust interchangeable lens if required.

Fix to wall, pole or camera unit using U bracket provided or other Raytec bracketry.

### **IMPORTANT:**

Ensure illuminator is rated to provide required viewing distances and select correct angle

Ensure illuminator is orientated in the correct direction

#### **STEP 4: Change IP address and connect to the illuminator (Pg. 11)**

We recommend the easiest and fastest way to identify and connect to illuminators is using the Raytec Discovery Tool where the IP address can be altered

#### **IMPORTANT:**

We recommend Raytec Discovery Tool as the easiest way to establish communication. If using IP address for direct communication, illuminator and computer must be in same network range.

#### **STEP 5: Illuminator Set-Up (Pg. 12-18)**

Raytec Discovery Tool Basics  
Log-in, Security & Basic Illuminator Setup  
Basic Web Page Functionality

#### **STEP 6: Basic Troubleshoot (Pg. 19)**

#### **Note :**

The external cables cannot be replaced. If one is damaged and the customer is unable to shorten and re-use the cable, the illuminator must not be powered.

## Wiring

The illuminator is supplied with a terminated CAT 5 cable with a waterproof Ethernet connector (supplied loose i.e. not fitted) and an auxiliary multi-core cable.

### Option 1 – Power via PoE

Connect an Ethernet cable (category 5 or better) using the T-568B wiring standard between the Power Sourcing Equipment (PSE) and the illuminator. Ensure that the PSE is sufficiently rated to power the Vario2 IPPOE Hybrid device as follows:

Model	PSE PoE Requirement
VAR2-IPPOE-hy4-1, hy4-1-C, hy6-1	IEEE 802.3at (HP PoE) $\geq 25.5W$
VAR2-IPPOE-hy8-1, hy8-1-C	Factory Software Version <3.5.0: 4 pair PoE $\geq 51W$ Factory Software version $\geq 3.5.x$ : IEEE 802.3bt or 4 pair PoE $\geq 51W$

The Factory Software version of the Illuminator is shown by characters 4, 5, 6 in the product serial number.

The CAT5 cable is both the power and data connection for the illuminator. The maximum Ethernet cable length is 100m (328 ft) without boosting the signal.

Ensure you make a waterproof connection to the RJ45 as shown below. Ensure the connector is waterproof and sealed after the connection is made.



To illuminator

RJ45-RJ45 connector

To Network

### Option 2 – Power from 24V DC

If using low voltage power, connect **24V DC** to the red (+ve) and black (-ve) cables of the auxiliary cable. In this case the Ethernet cable is a data connection only.

For either Option 1 or Option 2 above, connect external input trigger and external output as required – see table below:

Colour	Description	Wire Gauge (AWG)
Orange	External Input -Volt free or TTL +ve	22
Purple	External Input -Volt free or TTL GND	22
Yellow	External Output – Volt free	22
White	External Output - Volt free	22

**WARNING:** To maintain the IP rating of the product the multi-core auxiliary cable must be waterproofed and terminated appropriately even if it is not in use.

### PoE Detection – Resistance Selection Switch

There is a 3-way switch on the VAR2-IPPOE-hy8-1 and hy8-1-C illuminators which can be used to change the PoE detection resistance of the illuminator (24.9kΩ and PD class 6 is the factory default setting – Left Hand Position.).

The majority of PSE equipment require a detection resistance of 24.9kΩ to establish a PoE. The illuminator then uses a class resistance to identify how much power is required.

To allow the VAR2-IPPoE Hybrid 8 size product to be compatible with a large range of PSE devices, the switch can be configured as follows

Switch Position	Detection Resistance	Class	Comment
Left (default)	24.9kΩ	6	For use with 802.3bt compliant PSE's. This setting is also compatible with the most legacy products high power PSE.
Central	24.9kΩ	4	Compatible with legacy single signature high power PSE using class 4 power negotiation.
Right	12.5kΩ	4	Compatible with Phihong non standard high power PSE.

For further information regarding compatibility, check with the supplier of your PSE equipment.

To change the switch setting, turn OFF the power to the illuminator, remove the baseplate and access the switch as shown.

Baseplate fixing screws: Torque 0.6Nm.

Detection Resistance Selection Switch

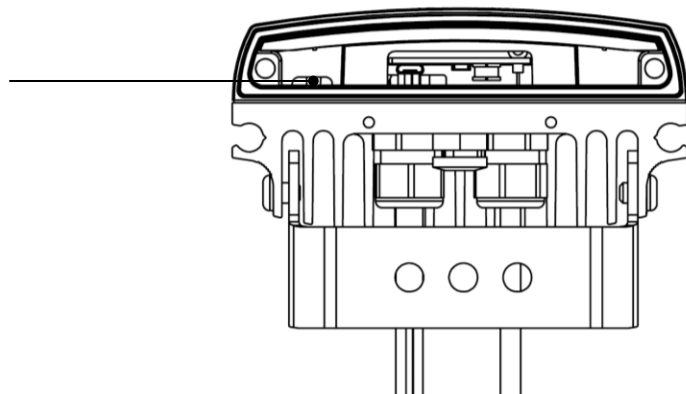



## Interchangeable Lenses: Changing the Angle

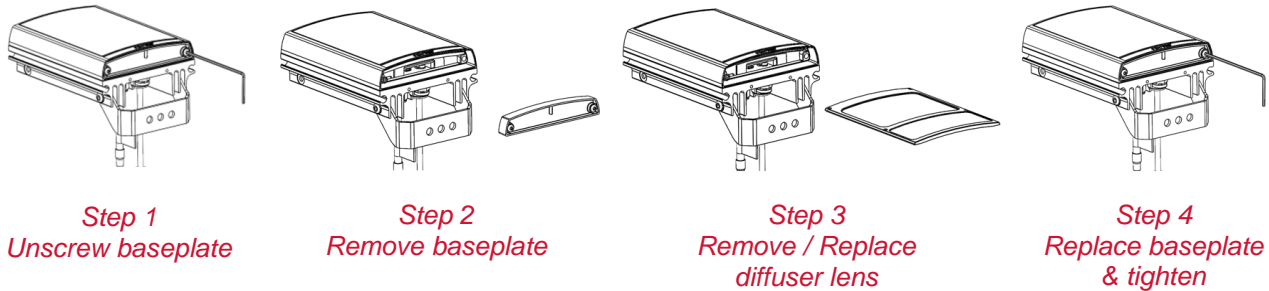

The illuminator is delivered with a 35° beam angle. To alter to 10°, remove the baseplate from the bottom of the product and remove the existing lens and then re-attach the baseplate securely. With no lens insert the product produces a 10° beam angle.

To alter to any other angle, remove the existing lens and insert the required lens which will have its angle indicated on it. Ensure the baseplate is securely re-attached to maintain waterproof integrity of the product.

The angles available as standard are: 10°x10° (NO lens / diffuser in place), 35°x10° and 60°x25°. Other angles are available to order: 80°x30° and 120°x50°.

Baseplate fixing screw: Torque 0.6Nm

## Installation

Vario2 IPPOE Hybrid is delivered as standard with a bracket at the bottom of the unit. This can be moved to the top of the unit if required.

Attach illuminator to wall, housing or pole using U-bracket provided or dedicated Raytec bracketry.

### Connect lamp to PSE and network.

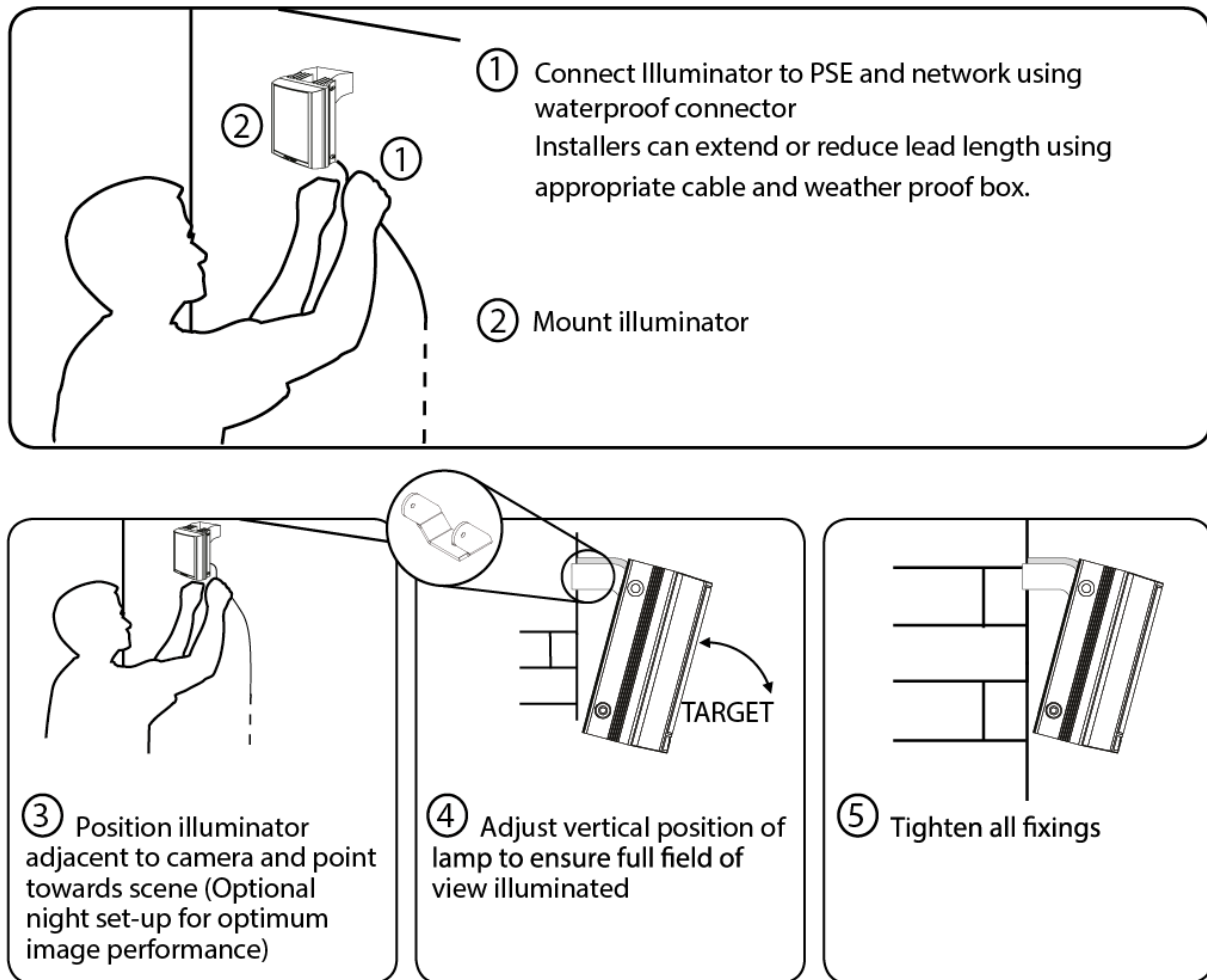

Notes :

Unit can alternatively be powered by 24V DC if required

Multi-core auxiliary cable also fitted to unit

- Use for alternative power (24V DC) if required
- Use for connecting external input and external output as required

To maintain the IP rating of the product, any cable not in use must be waterproofed and terminated appropriately.

## Connecting to the Network

### Assign an IP Address

VARIO2 IPPoE Hybrid illuminators with software version 3.5.x or above are set to DHCP by default therefore when you connect your illuminator to a network, you will find yourself in one of the scenarios below:

- Illuminator connected to a network with a DHCP server – in this instance, the illuminator will automatically be assigned an IP address.
- Illuminator connected to a network without a DHCP server – in this instance, the illuminator will be given an IP address starting with 169.254 with the last two octets being random but unique to other illuminators in the same state on the network. In this instance, you will need to set the IP address of the illuminator manually.

VARIO2 IPPoE Hybrid illuminators with software version < 3.5.0 have a default IP address (192.168.2.80) and this must be changed immediately to avoid any potential conflicts or communication errors.

There are two main ways to change the IP address of an illuminator:

#### **OPTION 1: Raytec Discovery Tool**

We recommend the easiest and fastest way to identify and connect to illuminators is using the Raytec Discovery Tool where the IP address can be altered (DHCP is enabled as standard). Using the Raytec Discovery Tool avoids the need to have the computer and illuminator in the same network range in order to alter the IP address. This free application is downloadable from our website or please contact Raytec.

To change the IP address using the Raytec Discovery Tool so that you can communicate with the illuminator(s) you can:

#### **Use DHCP**

If you have software version 3.5.x or above, and you are using a DHCP network, the illuminator will automatically assign a DHCP IP address on first power up.

If you have software version < 3.5.0 or you wish to change from a static IP address to a DHCP enabled IP address, you need to do the following:

Run the Raytec Discovery Tool. Single click on illuminator to highlight it. Select **Network** from bottom menu. Highlight DHCP option. Press **OK**, then **OK** again to the “Confirm Changes” dialog box. Press **Discover**. The illuminator should now appear with a valid IP address. You can now double click illuminator to navigate to it.

**WARNING:** Your network must have DHCP capability.

### **Manually set the IP address**

Run Raytec Discovery Tool. Single click on illuminator to highlight it. Select **Network** from bottom menu. Type in a new IP address and subnet mask - which must be compatible with your network. Check with your IT manager. After changing the IP address and subnet mask, press **OK**, then **OK** again to the “Confirm Changes” dialog box. Press **Discover**. You can now double click illuminator to navigate to it.

### **OPTION 2: Use the Illuminators Web Interface**

Alternatively, type the IP address of illuminator into a web browser and use the web interface using the “Network” tab on the left-hand side to select the Network page and manually alter the IP address or enable DHCP. For manual allocation of a static IP address it is important that the network administrator controls and ensures the IP addresses issued are unique and not repeated. In order to establish communication, the computer and illuminator must be in the same network range.

In either option above, if DHCP is enabled, your network must have DHCP capability.

Note: - If assigning the IP address fails, check that there is no firewall blocking the operation and that the computer and illuminator have IP addresses in the same range.

### **Raytec Discovery Tool Basics**

The Raytec Discovery Tool is downloadable from our website or you may request it from Raytec.

During the initial set-up we strongly recommend that you use the Raytec Discovery Tool on a computer on the same network as the Vario2 IPPOE Hybrid illuminators to discover and establish connection.

The illuminator responds to multicast messages - and therefore does not need to have a valid IP address in the same network range for the Raytec Discovery Tool to find it. But it does require a valid IP address for connection and communication. ALL IP addresses need to reside within the same network address range to ensure these components can communicate with each other.

With the Vario2 IPPOE Hybrid powered and attached to the same network, press **Discover** and the Raytec Discovery Tool will display a list of illuminators available on the network.

See instructions above on how to change IP address or enable DHCP in order to allow communication with the illuminator.

Once the IP address of the illuminators have been changed, you can double click on the illuminator from the Raytec Discovery Tool to navigate directly to the illuminator’s web interface.

### The Raytec Discovery Tool allows you to:-

- Discover all illuminators on the network – illuminators do not need a valid IP address to be discovered
- Alter IP address of illuminator – the illuminator must have a valid IP address to allow communication
- Disable/Enable DHCP
- Navigate directly to each illuminator – once a valid IP address has been assigned
- See the illuminators status
- See whether the illuminator is ON / OFF
- View the MAC address of each illuminator
- Change Network Settings
- Change the Name and Group Name
- See additional illuminator details including name, software version, model and the time the illuminator has been powered.

### Hierarchy of Photocell vs. Telemetry

- The telemetry function enables the choice of wavelength. The photocell must detect that it is dark for the telemetry function to operate.
- The photocell overrides the telemetry function during the day. If the external input/telemetry function needs to be operated 24 / 7, then the photocell function should be disabled from the settings / groups page.
- If the external input/telemetry is not active, then the unit will follow the photocell settings.

The system requires 15 seconds of light to deactivate the photocell and turn the illuminators off to avoid accidental turn off of the illuminators via car headlights or torches.

If illuminators are in groups, the following rules apply:

- ANY sending illuminator within a group which says it is dark will turn all the illuminators in the group on (subject to local illuminator settings)
- ALL illuminators in the group need to say it is light before all the group illuminators will go off together (subject to local conditions)

## Log-in, Security & Basic Illuminator Setup

Log-in using Operator or Administrator user names and passwords. Operator has limited access rights. Administrator has full access rights.

Defaults (User Names & Passwords are case sensitive):

Users & Passwords	Name	Password
Operator	user	password
Administrator	admin	password

In order to maintain maximum security of your system, we recommend you change the passwords at the earliest opportunity (for further information, please see GUI Access page and “Access / Passwords Section” of full installation instructions).

**When you log in with the default credentials for the administrator for the first time you will be forced to change the password,**

Take instant control of an illuminator by pressing the Override button on the home page. This will countdown for 30 minutes to allow the user to control the illuminator and then will revert to standard settings automatically or if the Override button is deselected. Override is only available when the illuminator mode is set to **Local**, **HTTP + Local** or **VMS + Local**.

To operate the illuminator via a VMS or third party application that uses the Raytec API, then the illuminator mode should be set to **VMS** or **VMS + Local**. In VMS mode the illuminator will ignore Photocell and External Input triggers and respond only to valid VMS commands. In **VMS + Local** mode the illuminators can be controlled via a VMS system whilst also still responding to local photocell and telemetry triggers.

To operate the illuminator with an application that uses the HTTP API, then the illuminator mode should be set to **HTTP** or **HTTP + Local**. In HTTP mode the illuminator will ignore Photocell and External Input triggers and respond only to valid HTTP commands. In **HTTP + Local** mode the illuminators can be controlled with HTTP commands whilst also still responding to local photocell and telemetry triggers.

VMS integration allows the illuminator(s) to be directly controlled and triggered by events within the VMS environment such as scheduled events, alarm triggers, camera commands, etc.

HTTP Integration allows the illuminator to be directly controlled and triggered on receipt of valid HTTP commands generated on the network from VMS, cameras or other components capable of generating HTTP commands.

The illuminator mode can be changed on the Settings / Groups page. The default illuminator mode is **Local**.

## Standard Setup – Factory Defaults

The illuminator is operating in Local mode and will respond only to its own photocell and telemetry status. By default, the illuminator is NOT assigned to a group.

The illuminator will turn ON / OFF automatically when the photocell detects it is dark / light at 100% (soft start) via the photocell.

The External Input will activate the illuminator at 100% (NOT soft start) for the duration of the input provided the photocell detects it is dark.

External Output: activated by photocell and will become active when short circuit, unless changed in advanced settings on the GUI.

## Factory Defaults

Name	VARIO2 IP
Group Name	<<Deliberately Left Blank>>
IP Address	Software version 3.5.x or above : Automatically assigned by DHCP if connected to a DHCP network otherwise IP address starts with 169.254 followed by 2 random octet numbers. Software version <3.5.0 : Static IP Address 192.168.2.80

Enable DHCP Checkbox	Selected – IP addresses will be automatically allocated. If illuminator is being operated on a DHCP enabled network, DHCP can be selected for automatic allocation of IP address.
Illuminator Mode	<i>Local</i> : Control the illuminator using the web interface. Illuminator will respond to its own photocell and telemetry events.

	<i>Photocell</i>	<i>External Input</i>
Trigger Control	Lamp Control	Lamp Control
Light Type	IR	WL
Respond to Group Commands	No, ignore group command	No, ignore group command
Lamp Mode on Trigger	On	On
Power (%)	100%	100%
Duration	All night	Duration of Input
Soft Start	On	Off

### Deterrent

Pattern = SOS

Frequency = Slow

## Advanced Settings

### Manual Override

Countdown Duration = 30 mins

### External Input

Type of Input = Volt Free

Active State = Short Circuit / Low

### External Output

Trigger State = Photocell Only

Active State = Short Circuit / Low

### Photocell

Photocell Sensitivity = 20 lux

## Basic Web Page Functionality

All web pages have the following information in the header bar

Model Type / Lamp Name / Group Name

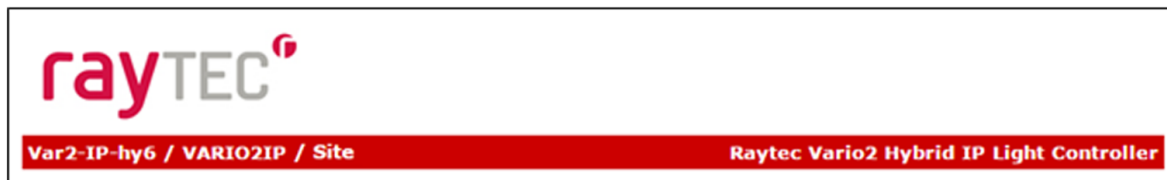

## Home Page

**Home**

This page allows the user to take direct/override control of the lamp or the group of lamps with which this lamp is associated.

Type:Var2-IP-hy6  
Name:VARIO2IP  
Group:Site  
Trig:None  
Status:

**Override**

Rev 3.5.0

Copyright © Raytec

User has access to Home Page and Diagnostics pages.

Administrator has access to all pages.



<u>Page Name</u>	<u>Functions available</u>
Home Page	Allows manual control of an individual illuminator or group of illuminators including power adjustment, wavelength choice and deterrent controls. Select override to operate above functions.
Settings / Groups	Allows detailed set-up and configuration of the illuminator including how it responds to Photocell and External Inputs, light type, duration on period, power levels, soft start, response to group commands, deterrent patterns and speeds. Allows illuminators to be allocated to a group or to create a new group. Selectable control of illuminator either locally, by VMS or HTTP commands.
Adv. Settings	Allows for further detailed setup of External Input, External Output, Photocell sensitivity level and duration of Override.
Access	Change passwords
Network	Allocate IP address and other network settings, select DHCP operation, allocate illuminator name, specify secondary HTTP port and disable port 80.
System Information	Indicates basic information about the illuminator. Ability to restore factory settings or restart illuminator.
Diagnostics	Basic diagnostics to enable 1 <sup>st</sup> level troubleshooting and additional diagnostics info.
Adv. Diagnostics	Advanced diagnostics to enable 2 <sup>nd</sup> level troubleshooting
Software Update	Indicates current software / firmware version. Ability to upload updated software / firmware version.
Log Off	We recommend logging off illuminator after every session

## Illuminator web interface note

You may see the model name of your illuminator cut short on the home page of your illuminator like below:

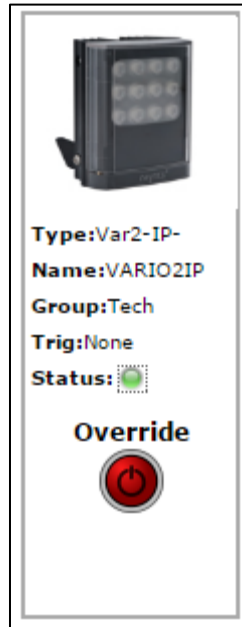

Due to a change to the format of our model names, the size of the illuminator details box above has been increased. If you have previously used a Vario IP PoE on your machine, your browser will have remembered the old style and will re-use this. You can force your browser to pull the size change in by removing temporary Internet files, this procedure is explained for Chrome and Internet Explorer browsers below.

### Chrome

1. Hold Ctrl-Shift-Del keys
2. Change drop down box to "the beginning of time"
3. Tick "*Cached images and files*" **ONLY. If others are ticked, untick.**
4. Select *Clear browsing data*

### Internet Explorer

1. Hold Ctrl-Shift-Del keys
2. Tick "*Preserve Favourites website data*" and "*Temporary Internet files and website files*" **ONLY. If others are ticked, untick.**
3. Select *Delete*

After performing the steps above, refresh the illuminator home page and the longer illuminator details box will appear.

Instructions for this procedure for other browsers can be found online.

## Ping

The illuminator will respond to a standard Ping command sent to its valid IP address. For the ping command to work the illuminator and computer must reside in the same network range.

## Basic Troubleshoot

- Check if the camera and illuminator are aligned correctly.
- For Infra-Red illumination, ensure that a Day and Night or Black and White camera is used and that the camera switches correctly into night mode.
- Check camera and lens. Is iris fully open at night and set correctly. Ensure camera is fully operational and has correct night time settings and capability.
- Ensure correct illuminator lens angle selected for required distance – check stated performance.
- Check the LED status indicator: if green LED indicator is lit on the bottom of the unit, then the unit is receiving power.
- If powering from PoE, ensure Power Sourcing Equipment (PSE) is suitably rated for the VARIO2 IPPOE Hybrid unit – see page 7 for required ratings – and for all 8 size units check correct PoE Detection Resistance has been selected – see page 8.
- If powering from low voltage 24V DC, check voltage applied and that power supply is suitably rated for the VARIO2 IPPOE Hybrid unit – see page 7 for required ratings.
- Check connection and wiring of CAT5 / 6 cable to VARIO2 IPPOE Hybrid. Verify link has been established with the router / switch to which the illuminator is connected and that the wiring is compatible with T-568B wiring standard.
- If the illuminators are correctly wired to the network, run the Raytec Discovery Tool and try to discover the illuminator on the network.

If the illuminator is discovered and the “State” indicator is grey, this indicates that there is no communications with the illuminator. Ensure IP Address and Subnet Mask of computer and illuminator are set within the same range. If not, alter IP address of illuminator or Enable DHCP on illuminator for automatic allocation of suitable IP address.

Use a Ping command to see if the illuminator and device are on the same network and have communication.

- If still unsuccessful try a different web browser.
- If no communication possible after above steps, please contact Raytec for further support or consider a Hard Reset of the illuminator.

***(Note : The light source (LEDs) of this illuminator is not replaceable. When the unit reaches its end of life the whole illuminator shall be replaced and re-cycled where possible)***

**Vario2 IPPOE Hybrid Instruction Guide 0610-D-00003 Rev 2.0.0 Short**

---

Raytec Global (excluding Americas)  
Tel: +44 (0) 01670 520055  
Fax: +44 (0)1670 819760  
sales@rayteccctv.com

Raytec Americas:  
Tel: +1 613 270 9990  
Toll Free: +1 888 505 8335  
ussales@rayteccctv.com