

INSTALLATION GUIDE

ET4500C IP Video Camera Over Coax

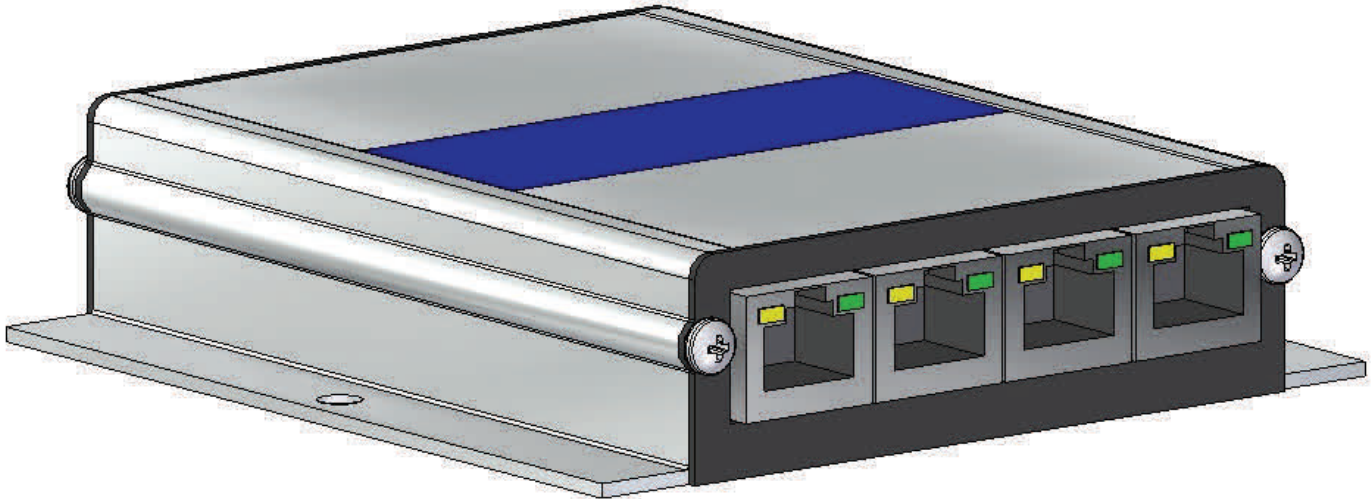

Description

The ET4500C is another component of the NITEK EtherStretch line. This Environmentally Hardened EtherStretch solution allows for the utilization of existing coax cable infrastructure to transmit data from IP cameras and other network devices. The ET4500C along with data can provide the power (PoE) to operate these network devices well beyond standard network limitations. The system can extend Ethernet to over 500m or 1640ft of coaxial cable making the ET4500C is ideal for retrofitting existing installations.

The ET4500C is a 4 channel transmitter that mates with any of the EtherStretch Multi-port series receiver units and require very little installation time and no set up or configuration. This system quickly turns any ordinary RG59 coax cable into a high speed network communication and PoE pathway. The ET4500C is completely transparent to the network thus requiring no IP and MAC addressing. Simply connect your network devices to the networking ports of the ET4500C transmitter and associated receiver along with existing cabling and the system begins communicating. LED indicators show the status and speed of network communications and PoE power.

The NITEK EtherStretch ET4500C reliably extends network communications to overcome cable distance limitations offering connectivity to devices in locations traditional networking does not allow. The units are constructed of industrial grade RoHS compliant plated aluminum with a corrosion resistant finish makes them extremely durable.

Patent Pending



04242014

NITEK®

USA

5410 Newport Drive, # 24
Rolling Meadows, IL 60008
Phone: (847) 259-8900
Fax: (847) 259-1300
E-mail: info@nitek.net
WWW.NITEK.NET

EUROPE

De Aar 99
8253 PN Dronten
The Netherlands
Tel: +31(0) 321 310 043
E-mail: info@nitekeurope.net
WWW.NITEK.NET

Important Safety Instructions

Read all Safety Instructions.

Keep the Instructions for future reference.

Be sure to HEED all Warnings.

Follow ALL instructions.

DO NOT use this device or any of the equipment described, near water.

Clean this device ONLY with a dry cloth.

DO NOT block any ventilation openings.

Install in accordance with the manufacturer's instructions.

DO NOT install near any heat sources such as radiators, heat registers, stoves or other apparatus (including amplifiers) that produce heat.

DO NOT defeat the safety purposes of polarized or grounding type plugs. A polarized plug has two blades, with one blade wider than the other. A grounding plug has two blades and has a third grounding prong. The wide blade and the grounding prong are provided for your safety. If the provided plug does not fit into your outlet, consult an electrician for replacement of the obsolete outlet.

DO NOT connect the unit to an electrical supply if the wiring or over current protection of the supply could be overloaded when the ratings listed on the unit are considered.

Protect the power cord from being walked on or pinched especially at plugs, convenience receptacles and other points where they exit from the device.

Only use attachments and/or accessories specified by the manufacturer.

Refer all servicing to qualified service personnel. Servicing is required when the device has been damaged in any way, such as the power supply cord or plug is damaged, liquid has been spilled on, or objects have fallen into the device, the device has been exposed to rain or moisture, does not operate normally or has been dropped.

WARNING: To reduce risk of fire or electric shock, do not expose this apparatus to rain or moisture.

Installation shall be performed ONLY by qualified personnel and must conform to all local codes.

Unless the device is specifically marked as a NEMA 3, 3R, 3S, 4, 4X, 6 or 6P enclosure, it is designed for indoor use ONLY and it must not be installed where exposed to rain or moisture.

Parts of the ET4500C

Link Side of Device

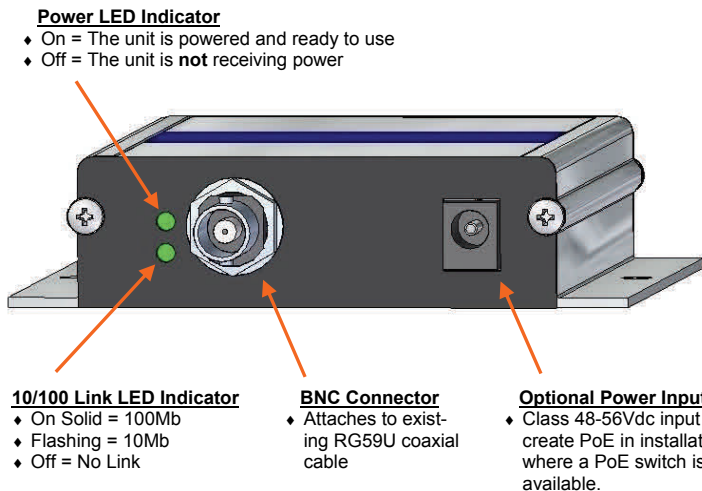

Network Side of Device

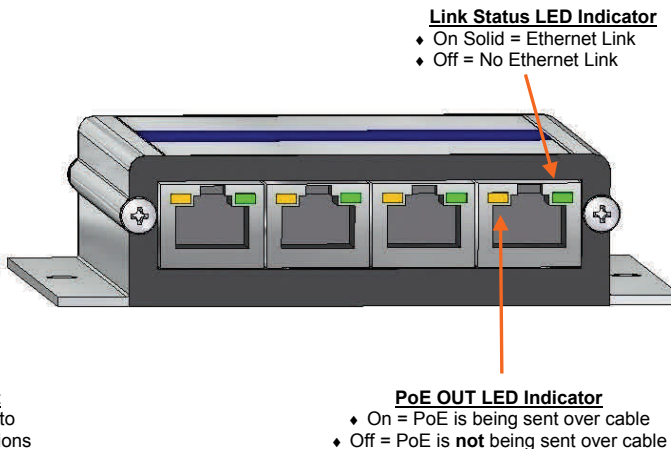

Installation Considerations

Wire and Cable Recommendations: The ET4500C is designed for use with RG59U 75 Ohm copper based 18AWG (American Wire Gauge) coaxial cable. The quality of which must be consistent with any reasonably serviceable cable condition. That is free from damage as in cuts, breaks, or cracks to the outer covering and insulated shielding which may compromise the signal conductivity of the cable.

For more specific information regarding wire types, gauges, and proper installation techniques please call Tech Support at (800)528-4343.

Ethernet & PoE: The ET4500C is designed to transmit and receive up to 100Mbps of Ethernet TCP/IP data and PoE from 15.4W (802.3af) to 25.5W (802.3at) at a maximum distance of 1,640ft / 500m. Before considering this solution be sure that the cables involved do not exceed the recommended maximum lengths. If the cable distance value is undetermined at the time of installation, we recommend the use of a Time Domain Reflectometer (TDR) which through the use of short rise time pulses can measure impedance characteristics, splices, and unknown cable distance estimates.

Power Supply Recommendations: The ET4500C is designed to be powered from either an ET1500C, ER8500C or a ER16500C receiver unit. The ET4500C must be externally powered in order to provide PoE power through the four IP Ports. The minimum input power required for four port PoE operation is 48Vdc @ 1Amp (48 Watts), the voltage range of the unit is 48Vdc to 56Vdc. If all four IP Ports are required to provide PoE+, the minimum input power required is 48Vdc @ 2.6Amps (125 Watts).

Installation & Setup

Equipment Requirements & Mounting: The process for utilizing the ET4500C is rather quick and easy. A common topology involves a length of existing coax cable up to 1,640 feet or 500 meters, the ET4500C transmitter and the associated rack mounted multi-port receiver such as the ER8500C or ER16500C, an IP camera or other peripheral network device. The IP camera must be either 802.3af or 802.3at compliant. That is requiring no more than 15.4 W 48VDC @ 350mA of 802.3af (PoE) or up to 25.5W 56VDC @ 600mA of 802.3at (PoE+) power for proper attached device operation.

The method for facilitating Ethernet communication and PoE over RG59U cable starts with connecting a receiver, via a CAT5e/CAT6 patch cable, to a server or other network switch. The receiver unit BNC coaxial connector port enables connectivity to the ET4500C four Port Transmitter via . The IP devices interface with the ET4500C via four Link Ports (RJ45) and CAT5e/CAT6 cables. The link port output of the ET4500C intern connects to the length of RG59U cable by its BNC connector. Power from the multi-port receiver provides operational PoE for the ET4500C. An illustration of this is represented below in the "Installment Topology" diagram.

Upon final power up the devices will undergo initialization and auto-configuration processes (see LED Indicator chart on pg 6) which may take a number of seconds, time variations are device/installation/topology parameter dependent, to complete before PoE and Ethernet communication commences. For optimal performance referring to the PoE Distance Chart (see pg 6) and adhering to the IP camera operational specifications is recommended. If issues arise during the installation process please see the "Trouble Shooting Tips" section (pg 7). You may also contact our web based live tech support at: www.nitek.net/index.htm or call (800)528-4343 in order to speak with one of our engineers directly.

Installment Topology

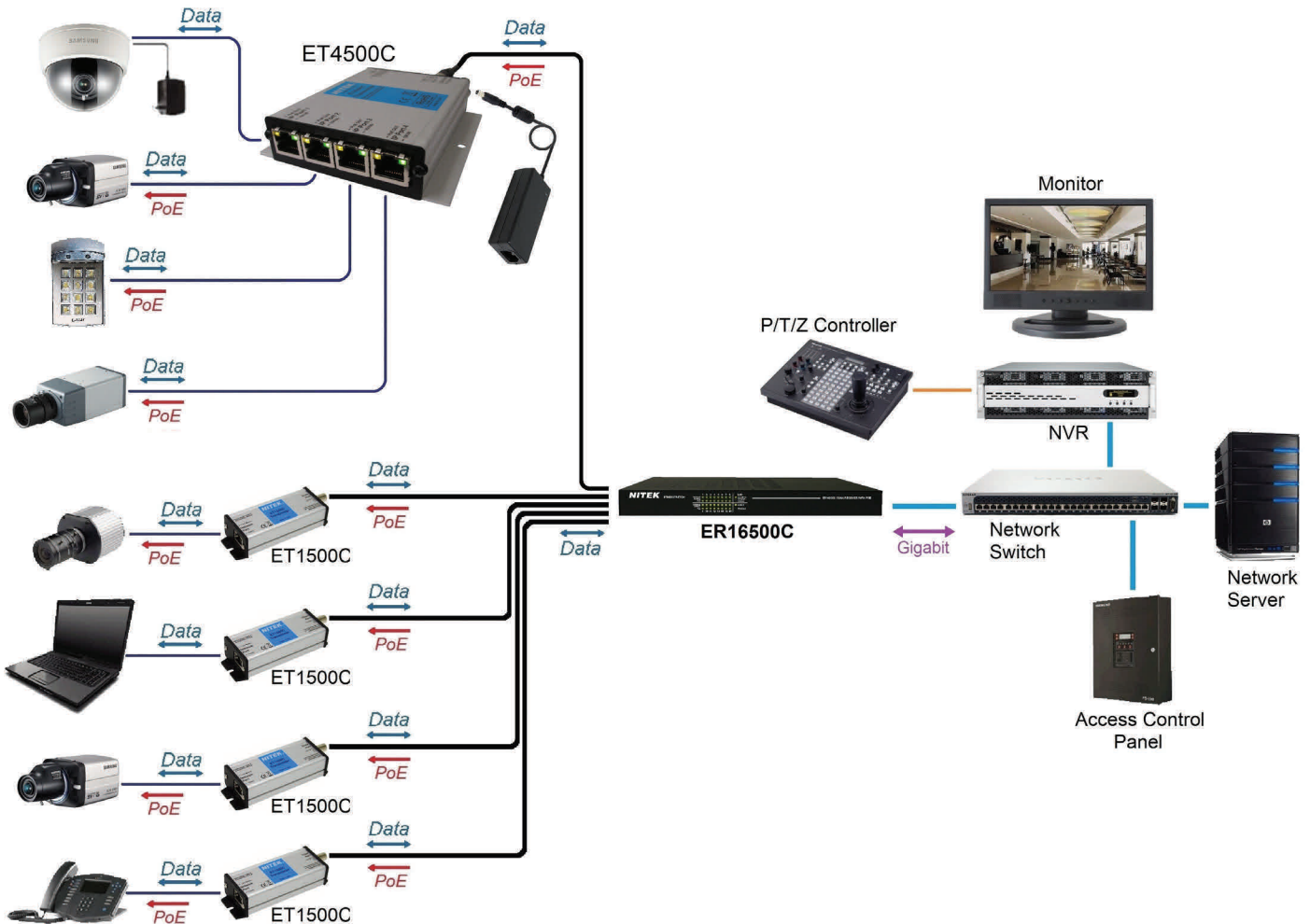

Device Dimensions

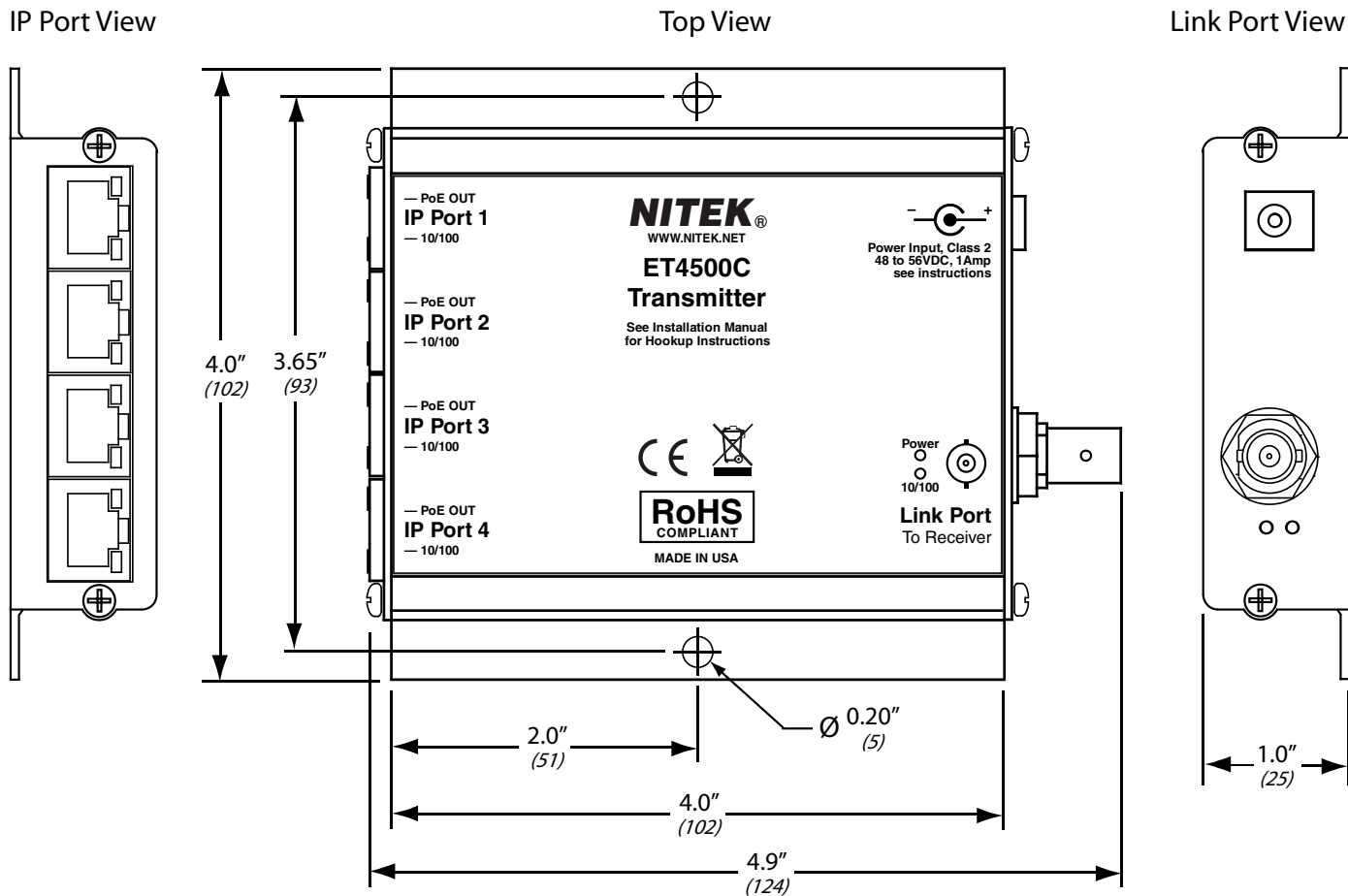

568B Pin out Termination

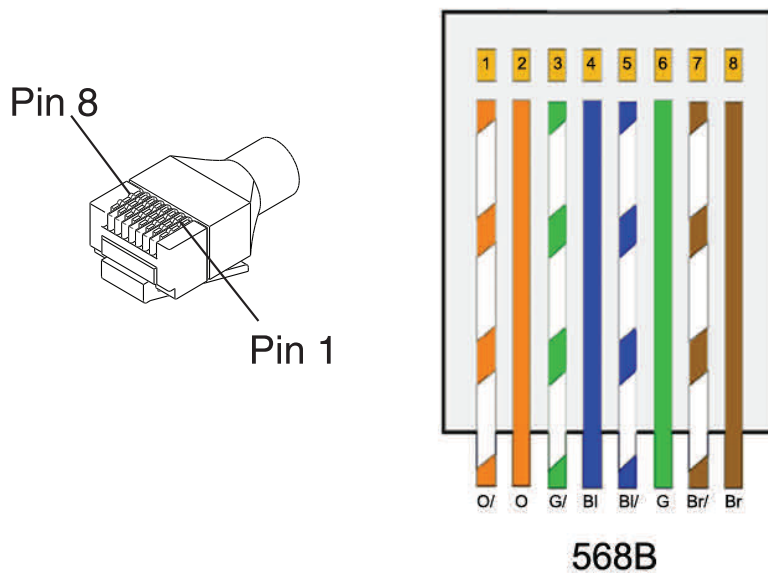

Connectivity Status

Link Side of Device

Network Side of Device

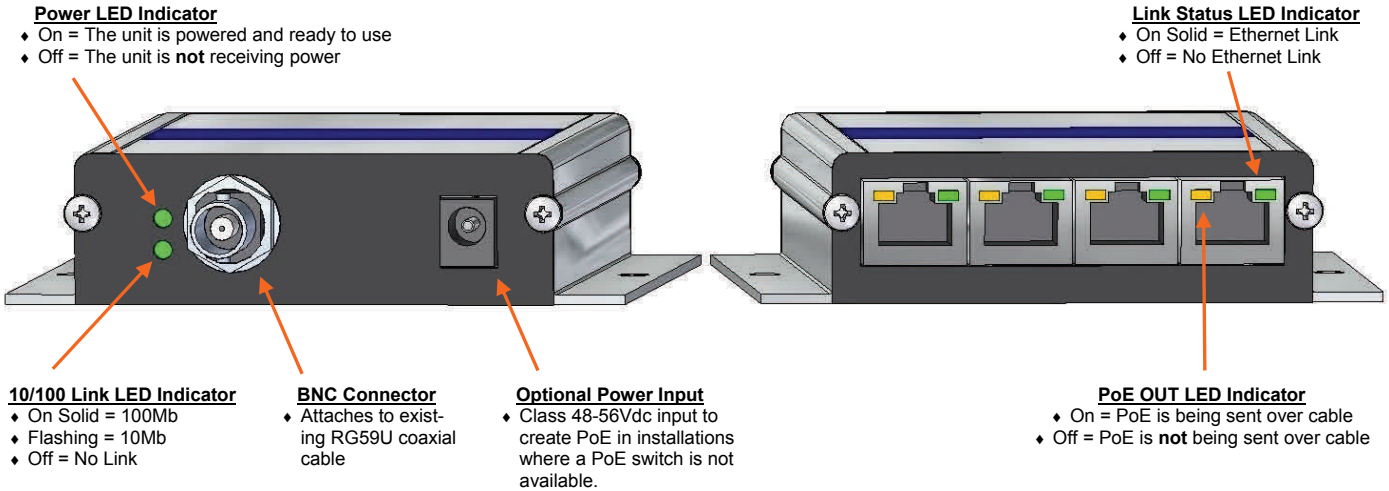

LED INDICATORS				
Connector	LED	OFF	ON	FLASHING
Network Port	PoE Out	No PoE Power Out	PoE Power Good	
	Link Status	No Ethernet Link	Ethernet Link Good	
Link Port	Power	No Power	Power Good	
	10/100	No Link	100Mb	10Mb

PoE Distance Chart

Available PoE Wattage At PoE Device

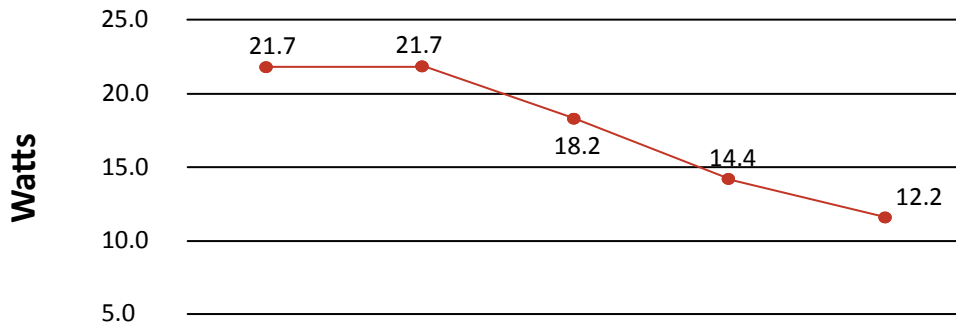

100 Meters 328 Feet	200 Meters 656 Feet	300 Meters 984 Feet	400 Meters 1,312 Feet	500 Meters 1,640 Feet
21.7 Watts	21.7 Watts	18.2 Watts	14.4 Watts	12.2 Watts

* Results charted were calculated using RG59U coaxial cable with a 20AWG center conductor.

Troubleshooting

PROBLEM	POSSIBLE CAUSE
No video/data	Check camera and ET4500C device connections. Check coax cable condition and BNC connectors. Check that the camera is powered. Check that supplied camera power meets manufacturer's specifications. Check cable that cable distances do not exceed PoE capabilities. Refer to chart on page 6. Check that coax cable does not exceed the Ethernet data transmission operating distances of the ET4500C. Check link & device status. See chart on page 6.
Video/data loss	Check network switch terminations & link status. Check network routing tables. Confer with site Network Administrator

For Tech Support Call 1-(800)528-4343

Technical Specifications

Network Transmission Device

Network Port	Four RJ45 Jacks
Link Port	BNC Coax Jack
Ethernet	Auto Configuring 100BASE-TX Full Duplex
Power Connector	2.5mm (ID) x 5.5mm (OD) Barrel
LED Indicators	Link Status, Power, PoE out, 10Mb or 100Mb
PoE Compliance	IEEE 802.3af & IEEE 802.3at
Max Operating Distance	1,640ft /500m
PoE Output	45 Watts total output power With a 1A/48Vdc included power supply
DC Voltage Input	48 to 56Vdc, 1 to 5A
Operating Temperature	-40° to 75° C / -40° to 167° F
Humidity	Up to 95% non-condensing
Dimensions	1.0" x 4.0" x 4.9" including tabs & BNC (25 x 102 x 124mm)
Mounting Hole	0.20" Diameter (5.0mm)
Shipping Dimensions	3.0" x 6.9" x 9.7" (76 x 175 x 246mm)
Shipping Weight	2.0lbs (0.91kg)

Product Warranty and Return Information

Limited Warranty Network Extender Products

NITEK warrants the original consumer purchaser that the Network Extender products that it sells will be free from defects in material and workmanship for a period of two years from date of purchase. If any such product proves defective by our inspection, after sale to the original consumer purchaser, NITEK, at its option, will either repair the defective product without charge for parts and labor or will provide a replacement in exchange for the defective product.

In order to obtain service under this warranty, the customer must notify NITEK of the defect before expiration of the warranty period. The customer shall be responsible for packaging and shipping the defective product to the service location designated by NITEK with shipping charges prepaid. NITEK shall pay for the return of the product to the purchaser if the shipment is to a location within the U.S.A. The purchaser shall be responsible for paying all shipping charges, duties and taxes if the product is returned from a location outside the U.S.A.

This warranty shall not apply to any defect, failure or damage caused by improper use or improper or inadequate maintenance or care, or to any product which shall have been repaired or altered outside our plant in any way, or which has been operated in a manner exceeding its specifications, or which has had the serial number removed. NITEK shall not be obligated to furnish service under this warranty: a) to repair damage resulting from attempts by personnel other than NITEK representatives to repair or service the product; b) to repair damage resulting from improper use or connection to incompatible equipment; or c) to service a product that has been modified or integrated with other products when the effect of such modification or integration increases the time or difficulty of servicing the product.

This warranty is given by NITEK with respect to the Network Extender products in lieu of any other warranties, express or implied. NITEK disclaims any implied warranties of merchantability or fitness for a particular purpose. NITEK's responsibility to repair or replace a defective product is the sole exclusive remedy provided to the purchaser for breach of this warranty. NITEK will not be liable for any indirect, incidental or consequential damages irrespective of whether NITEK has advance notice of the possibility of such damages.

Return Policy

- A. All returns for warranty, repair, credit or any other reason must be pre-authorized. A return merchandise authorization (RMA) form must be requested from the NITEK Customer Service Department. The form, which will be emailed to the customer, must be filled out completely and emailed back to the sender at NITEK for approval. An RMA number will be assigned if the request is approved. In any event, the customer will be notified by NITEK customer service of the outcome. All approved returns must be shipped freight prepaid, insured and properly packaged. A copy of the approved RMA form must be enclosed in the shipping container with the goods being returned and the RMA number must be marked in a visible area on the exterior of the container.
- B. Credit Returns must have been purchased within the last 30 days of the date of the receipt of the equipment at NITEK. Credit returns must be current products listed on the NITEK published price list, in effect at the time of the return and must be in new and saleable condition, with all factory packaging. All Credit returns are subject to a restocking charge of up to 40%. Additional restocking and/or refurbishing charges may be assessed upon inspection. If it is determined by NITEK that the returned equipment does not meet these conditions, a credit will not be issued.