

# KT-400

## Ethernet Four-Door Controller



## Installation Manual

**KANTECH**

DN2003-1803

V01.11

## Contents

Pre-install information .....	7
Copyright information .....	7
Safety instructions .....	7
Technical support .....	8
Overview .....	10
Compatible with .....	10
IP devices .....	10
Four on-board doors .....	10
Communication ports .....	10
IP connectivity .....	11
Inputs .....	11
Lock outputs .....	11
Relay outputs .....	11
Reader outputs .....	12
Reader interfaces .....	12
Elevator interface .....	12
Alarm panel interface .....	12
Automatic port detection .....	12
Downloadable firmware .....	12
Trouble and reporting .....	12
Visual status indicators (LEDs) .....	13
Built-in SPI expansion .....	13
System architecture .....	17
Heartbeat LED patterns .....	20
Technical specifications .....	21
Electrical specifications .....	22
KT-400 ethernet four-door controller models, expansion modules models, related documentation and miscellaneous items .....	23
Models information .....	25
Installing the KT-400 Ethernet Four-Door Controller .....	26
Preparing to Install the KT-400 Ethernet Four-Door Controller .....	26
Physical installation .....	26
Earth grounding .....	26
Door locking devices .....	26
Hooking up inputs .....	27
Relay controlled outputs .....	29
Auxillary outputs .....	29
Tamper protection .....	29
Connecting the KT-400 Ethernet Four-Door Controller .....	30
Connecting the VC-485 or the USB-485 to the RS-485 Bus .....	30
Connecting the Master Controller to the Host PC via RS-232 .....	31
Connecting over Corporate Network (LAN) .....	31
Powering the KT-400 Ethernet Four-Door Controller .....	32
SPI Expansion Port .....	33
Important installation rules about expansion modules .....	34
Troubleshooting .....	38
Default initialization .....	39
KT-400 Ethernet Four-Door Controller Maintenance Recommendations .....	40
Configuring the KT-400 using a browser .....	41
Activating the KT-400 .....	41
Activating Standalone mode .....	41
Other ways to activate Standalone mode .....	42
Using EntraPass mode .....	42

Configuring the KT-400 Ethernet Four-Door Controller with the KT-Finder ..... 43  
Network Configuration Information Sheet ..... 45  
Installation checklist ..... 47  
Inputs and outputs assignments sheet ..... 49  
Appendix A ..... 52  
    Compliance specifications ..... 52  
        UL ..... 52  
        UL 294 compliance notice ..... 52  
        UL 1076 compliance notice ..... 52  
        FCC & ICC ..... 54  
        CE & C-Tick ..... 54  
        EN50133 compliance notes and requirements ..... 54

## **TYCO INTERNATIONAL LTD END-USER LICENSE AGREEMENT**

FOR KANTECH Software Provided With or Without Products or Components

### **IMPORTANT - READ CAREFULLY**

KANTECH Software purchased with or without Products and Components is copyrighted and is purchased under the following license terms:

- This End-User License Agreement (“EULA”) is a legal agreement between You (the company, individual or entity who acquired the Software and any related Hardware) and KANTECH, the manufacturer of the integrated security systems and the developer of the software and any related products or components (“HARDWARE”) which You acquired.
- If the KANTECH software product (“SOFTWARE PRODUCT” or “SOFTWARE”) is intended to be accompanied by HARDWARE, and is NOT accompanied by new HARDWARE, You may not use, copy or install the SOFTWARE PRODUCT. The SOFTWARE PRODUCT includes computer software, and may include associated media, printed materials, and “online” or electronic documentation.
- Any software provided along with the SOFTWARE PRODUCT that is associated with a separate end-user license agreement is licensed to You under the terms of that license agreement.
- By installing, copying, downloading, storing, accessing or otherwise using the SOFTWARE PRODUCT, You agree unconditionally to be bound by the terms of this EULA, even if this EULA is deemed to be a modification of any previous arrangement or contract. If You do not agree to the terms of this EULA, KANTECH is unwilling to license the SOFTWARE PRODUCT to You, and You have no right to use it.

### **SOFTWARE PRODUCT LICENSE**

- a - The SOFTWARE PRODUCT is protected by copyright laws and international copyright treaties, as well as other intellectual property laws and treaties. The SOFTWARE PRODUCT is licensed, not sold.

### **1 - GRANT OF LICENSE - This EULA grants You the following rights:**

- a - Software Installation and Use - For each license You acquire, You may have only one copy of the SOFTWARE PRODUCT installed.
- b - Storage/Network Use - The SOFTWARE PRODUCT may not be installed, accessed, displayed, run, shared or used concurrently on or from different computers, including a workstation, terminal or other digital electronic device (“Device”). In other words, if You have several workstations, You will have to acquire a license for each workstation where the SOFTWARE will be used.
- c - Backup Copy - You may make back-up copies of the SOFTWARE PRODUCT, but You may only have one copy per license installed at any given time. You may use the back-up copy solely for archival purposes. Except as expressly provided in this EULA, You may not otherwise make copies of the SOFTWARE PRODUCT, including the printed materials accompanying the SOFTWARE.

### **2 - DESCRIPTION OF OTHER RIGHTS AND LIMITATIONS**

- a - Limitations on Reverse Engineering, Decompilation and Disassembly - You may not reverse engineer, decompile, or disassemble the SOFTWARE PRODUCT, except and only to the extent that such activity is expressly permitted by applicable law notwithstanding this limitation. You may not make any changes or modifications to the Software, without the written permission of an officer of KANTECH. You may not

remove any proprietary notices, marks or labels from the Software Product. You shall institute reasonable measures to ensure compliance with the terms and conditions of this EULA.

- b** - Separation of Components - The SOFTWARE PRODUCT is licensed as a single product. Its component parts may not be separated for use on more than one HARDWARE unit.
- c** - Single INTEGRATED PRODUCT - If You acquired this SOFTWARE with HARDWARE, then the SOFTWARE PRODUCT is licensed with the HARDWARE as a single integrated product. In this case, the SOFTWARE PRODUCT may only be used with the HARDWARE as set forth in this EULA.
- d** - Rental - You may not rent, lease or lend the SOFTWARE PRODUCT. You may not make it available to others or post it on a server or web site.
- e** - Software Product Transfer - You may transfer all of Your rights under this EULA only as part of a permanent sale or transfer of the HARDWARE, provided You retain no copies, You transfer all of the SOFTWARE PRODUCT (including all component parts, the media and printed materials, any upgrades and this EULA), and provided the recipient agrees to the terms of this EULA. If the SOFTWARE PRODUCT is an upgrade, any transfer must also include all prior versions of the SOFTWARE PRODUCT.
- f** - Termination - Without prejudice to any other rights, KANTECH may terminate this EULA if You fail to comply with the terms and conditions of this EULA. In such event, You must destroy all copies of the SOFTWARE PRODUCT and all of its component parts.
- g** - Trademarks - This EULA does not grant You any rights in connection with any trademarks or service marks of KANTECH or its suppliers.

### **3 - COPYRIGHT**

All title and intellectual property rights in and to the SOFTWARE PRODUCT (including but not limited to any images, photographs, and text incorporated into the SOFTWARE PRODUCT), the accompanying printed materials, and any copies of the SOFTWARE PRODUCT, are owned by KANTECH or its suppliers. You may not copy the printed materials accompanying the SOFTWARE PRODUCT. All title and intellectual property rights in and to the content, which may be accessed through use of the SOFTWARE PRODUCT, are the property of the respective content owner and may be protected by applicable copyright or other intellectual property laws and treaties. This EULA grants You no rights to use such content. All rights not expressly granted under this EULA are reserved by KANTECH and its suppliers.

### **4 - EXPORT RESTRICTIONS**

You agree that You will not export or re-export the SOFTWARE PRODUCT to any country, person, or entity subject to US export restrictions.

### **5 - CHOICE OF LAW**

This Software License Agreement is governed by the laws of the State of New York.

### **6 - LIMITED WARRANTY**

#### **a - NO WARRANTY**

KANTECH PROVIDES THE SOFTWARE "AS IS" WITHOUT WARRANTY. KANTECH DOES NOT WARRANT THAT THE SOFTWARE WILL MEET YOUR REQUIREMENTS OR THAT OPERATION OF THE SOFTWARE WILL BE UNINTERRUPTED OR ERROR-FREE.

#### **b - CHANGES IN OPERATING ENVIRONMENT**

KANTECH shall not be responsible for problems caused by changes in the operating characteristics of the HARDWARE, or for problems in the interaction of the SOFTWARE PRODUCT with non-KANTECH SOFTWARE or HARDWARE PRODUCTS.

**c - LIMITATION OF LIABILITY; WARRANTY REFLECTS ALLOCATION OF RISK**

IN ANY EVENT, IF ANY STATUTE IMPLIES WARRANTIES OR CONDITIONS NOT IN THIS LICENSE AGREEMENT, KANTECH'S ENTIRE LIABILITY UNDER ANY PROVISION OF THIS LICENSE AGREEMENT SHALL BE LIMITED TO THE GREATER OF THE AMOUNT ACTUALLY PAID BY YOU TO LICENSE THE SOFTWARE PRODUCT AND FIVE US DOLLARS (USD\$5.00). BECAUSE SOME JURISDICTIONS DO NOT ALLOW THE EXCLUSION OR LIMITATION OF LIABILITY FOR CONSEQUENTIAL OR INCIDENTAL DAMAGES, THE ABOVE LIMITATION MAY NOT APPLY TO YOU.

**d - DISCLAIMER OF WARRANTIES**

THIS WARRANTY CONTAINS THE ENTIRE WARRANTY AND SHALL BE IN LIEU OF ANY AND ALL OTHER WARRANTIES, WHETHER EXPRESSED OR IMPLIED (INCLUDING ALL IMPLIED WARRANTIES OF MERCHANTABILITY OR FITNESS FOR A PARTICULAR PURPOSE) AND OF ALL OTHER OBLIGATIONS OR LIABILITIES ON THE PART OF KANTECH. KANTECH MAKES NO OTHER WARRANTIES. KANTECH NEITHER ASSUMES NOR AUTHORIZES ANY OTHER PERSON PURPORTING TO ACT ON ITS BEHALF TO MODIFY OR TO CHANGE THIS WARRANTY, NOR TO ASSUME FOR IT ANY OTHER WARRANTY OR LIABILITY CONCERNING THIS SOFTWARE PRODUCT.

**e - EXCLUSIVE REMEDY AND LIMITATION OF WARRANTY**

UNDER NO CIRCUMSTANCES SHALL KANTECH BE LIABLE FOR ANY SPECIAL, INCIDENTAL, CONSEQUENTIAL OR INDIRECT DAMAGES BASED UPON BREACH OF WARRANTY, BREACH OF CONTRACT, NEGLIGENCE, STRICT LIABILITY, OR ANY OTHER LEGAL THEORY. SUCH DAMAGES INCLUDE, BUT ARE NOT LIMITED TO, LOSS OF PROFITS, LOSS OF THE SOFTWARE PRODUCT OR ANY ASSOCIATED EQUIPMENT, COST OF CAPITAL, COST OF SUBSTITUTE OR REPLACEMENT EQUIPMENT, FACILITIES OR SERVICES, DOWN TIME, PURCHASERS TIME, THE CLAIMS OF THIRD PARTIES, INCLUDING CUSTOMERS, AND INJURY TO PROPERTY.

**WARNING: KANTECH recommends that the entire system be completely tested on a regular basis. However, despite frequent testing, and due to, but not limited to, criminal tampering or electrical disruption, it is possible for this SOFTWARE PRODUCT to fail to perform as expected.**

**h - Separation of Components** - The SOFTWARE PRODUCT is licensed as a single product. Its component parts may not be separated for use on more than one HARDWARE unit.

**i - Single INTEGRATED PRODUCT** - If You acquired this SOFTWARE with HARDWARE, then the SOFTWARE PRODUCT is licensed with the HARDWARE as a single integrated product. In this case, the SOFTWARE PRODUCT may only be used with the HARDWARE as set forth in this EULA.

**j - Rental** - You may not rent, lease or lend the SOFTWARE PRODUCT. You may not make it available to others or post it on a server or web site.

**k - Software Product Transfer** - You may transfer all of Your rights under this EULA only as part of a permanent sale or transfer of the HARDWARE, provided You retain no copies, You transfer all of the SOFTWARE PRODUCT (including all component parts, the media and printed materials, any upgrades and this EULA), and provided the recipient agrees to the terms of this EULA. If the SOFTWARE PRODUCT is an upgrade, any transfer must also include all prior versions of the SOFTWARE PRODUCT

**l - Termination** - Without prejudice to any other rights, KANTECH may terminate this EULA if You fail to comply with the terms and conditions of this EULA. In such event, You must destroy all copies of the SOFTWARE PRODUCT and all of its component parts.

**m - Trademarks** - This EULA does not grant You any rights in connection with any trademarks or service marks of KANTECH or its suppliers.

## Pre-install information

To the Installer: If you are familiar with the installation, you can use the installation checklist on page 46 with the  symbol.

## Copyright information

© 2018 Tyco International Ltd. and its Respective Companies. All Rights Reserved. All specifications were current as of publication date and are subject to change without prior notice. EntraPass, Kantech and the Kantech logo are trademarks of Tyco International Ltd. and its Respective Companies.

## Safety instructions

### **Important: NEVER INSTALL THE EQUIPMENT DURING A LIGHTNING STORM!**

This equipment, KT-400 Ethernet Four-Door Controller Model KT-400-EU, shall be used installed and used within an environment that provides the pollution degree max 2 and over voltages category II NON HAZARDOUS LOCATIONS, INDOOR only. The equipment is FIXED and PERMANENTLY CONNECTED and is designed to be installed by Service Persons only;

[service person is defined as a person having the appropriate technical training and experience necessary to be aware of hazards to which that person may be exposed in performing a task and of measures to minimize the risks to that person or other persons.] The equipment is installed in a metallic cabinet that meets the applicable requirements for a FIRE ENCLOSURE.

**Note:** When installed on the North American Market, powered via the UL, cUL Listed 75VA Transformer, the KT-400 Ethernet Four-Door Controller shall be connected to the mains by a **LICENSED ELECTRICIAN** in accordance with the applicable rules of the National Electrical Code or Canadian Electrical Code regarding this type of connection.

1. The **connection to the mains supply** must be made as per the local authorities rules and regulations: In the UK as per BS6701. An appropriate disconnect device must be provided as part of the building installation. Where it is not possible to rely on the identification of the NEUTRAL in the AC MAINS SUPPLY, the disconnecting device must disconnect both poles simultaneously (LINE and NEUTRAL).
2. **AVOID setting up** the equipment near heaters, air conditioners, ventilators, and/or refrigerators; **DO NOT** select a place that exposes your controller to direct sunlight, excessive heat, moisture, vapors, chemicals or dust.
3. If **during the installation** a knockout on the cabinet is removed, it is the installer's responsibility to ensure that the same degree of protection for the cabinet is provided by the use of bushings, fittings, adequate sealant, etc.
4. The metallic **cabinet must be secured to the building structure before** operation. Use four (4) stainless steel tapping screws #8, 32 mm (1.25 in) to mount the cabinet.
5. The **ground connection** must be as shown within the included diagram, or equivalent.
6. **Internal wiring** must be routed in a manner that prevents:
  - Excessive strain on wire and on terminal connections;
  - Loosening of terminal; connection
  - Damage of conductor insulation;
  - Reducing the clearance between SELV (Safety Extra Low Voltage) circuits and NON-POWER Limited Circuits (Battery wires);
  - Route the battery wires away from the rest of the SELV circuits.
7. It is the end-user and/or installer's responsibility to ensure that the disposal of the used batteries is made according to the waste recovery and recycling regulations applicable to the intended market.
8. There are **no serviceable parts within the equipment**; For any issues regarding the equipment please contact your installer.
9. Before leaving the premises, the Ethernet communication lines must first be connected to an approved (acceptable to local authorities) type Network Interface Device (NID), (UL installations, UL 60950 listed NID, for ULC installations CAN/CSA C22.2, No. 60950-1 Certified NID). All wiring shall be performed according to the local electrical codes.
10. **DISCONNECT POWER BEFORE SERVICING.**

## Technical support

For technical assistance with this and other Kantech products, contact technical support, Monday to Friday. See the following table for the technical support phone numbers.

<b>USA and Canada</b>		<b>GMT - 05:00</b>	
<b>North America</b>	Toll Free	+1 888 222 1560	08:00 to 20:00
	Direct	+1 450 444 2030	kantechsupport@tycoint.com
<b>Latin America</b>		<b>GMT - 03:00</b>	
<b>Argentina, Buenos Aires</b>	Direct	+54 11 5199 3104	08:00 to 20:00
<b>Brazil, Sao Paolo</b>	Direct	+55 11 3181 7377	ingenieria@tycoint.com
<b>Chile, Santiago</b>	Direct	+56 2 3210 9662	
<b>Colombia, Bogota</b>	Direct	+57 1 344 1422	
<b>Colombia, Cali</b>	Direct	+57 2 891 2476	
<b>Colombia, Medellin</b>	Direct	+57 4 204 0519	
<b>Costa Rica, National</b>	Direct	+506 4 000 1655	
<b>Dominican Republic, Santo Domingo</b>	Direct	+1 829 235 3047	
<b>El Salvador, San Salvador</b>	Direct	+503 2 136 8703	
<b>Guatemala, Guatemala City</b>	Direct	+502 2 268 1206	
<b>Mexico, Mexico City</b>	Direct	+52 55 8526 1801	
<b>Panama, Panama City</b>	Direct	+507 836 6265	
<b>Peru, Lima</b>	Direct	+51 1 642 9707	
<b>Venezuela, Caracas</b>	Direct	+58 212 720 2340	
<b>Asia</b>		<b>GMT + 08:00</b>	
	Toll free	+800 CALL TYCO +800 2255 8926	09:00 to 17:00 apac.support@tycoint.com
	Direct	+86 21 6023 0650	
<b>China</b>	Direct	+400 671 1528	
<b>India</b>	Direct	+1 800 1082 008	
<b>Australia</b>	Direct	+02 9684 3980	



EMEA	GMT + 01:00		
	Toll free	+800 CALL TYCO	
		+800 2255 8926	
	Direct	+31 475 352 722	
<b>United Kingdom</b>	Direct	+44 330 777 1300	08:00 TO 18:00
<b>Israel</b>	Direct	+972 772 201 350	emea-accesscontrol-support@tycoint.com
<b>Spain</b>	Direct	+900 99 31 61	
<b>France</b>	Direct	+0800 90 79 72	
<b>Germany</b>	Direct	+0800 1806 757	
<b>Italy</b>	Direct	+39 0230 510 112	
<b>Belgium</b>	Direct	+0800 76 452	
<b>Ireland</b>	Direct	+180 094 3570	
<b>Bahrain</b>	Direct	+800 04127	
<b>Nordic countries</b>	Direct	+45 4494 9001	
<b>Denmark</b>	Direct	+45 4494 9001	
<b>Greece</b>	Direct	+00800 3122 9453	
<b>Russia</b>	Direct	+81 0800 2052 1031	
<b>Turkey</b>	Direct	+00800 31923007	
<b>United Arab Emirates</b>	Direct	+800 03107123	
<b>South Africa</b>	Direct	+27 21100 3882	

## Overview

The KT-400 Ethernet Four-Door Controller is designed to meet the highest standards of access control and point monitoring applications. Here are the features of the KT-400 Ethernet Four-Door Controller.

## Compatible with

The KT-400 Ethernet Four-Door Controller is compatible with all EntraPass Editions v5.00 and higher:

- EntraPass Special Edition
- EntraPass Corporate Edition with a Multi-site Gateway
- EntraPass Global Edition with a Multi-site Gateway
- EntraPass Global Edition with a Global Gateway
- EntraPass Global Edition with a KT-NCC Network Communications Controller

## IP devices

- **EntraPass:** The KT-400 Ethernet Four-Door Controller can be configured with all EntraPass Editions v5.01 and higher.

**Note:** A KT-400 Ethernet Four-Door Controller firmware download is possible with EntraPass v4.01 and higher.

- **Web Configuration Page:** The Web Configuration Page is accessible through any browser. It can be used to verify and configure the IP settings of the following Kantech devices: the KT-400 Ethernet Four-Door Controller, the KT-NCC and the Kantech IP Link. Refer to the procedure “Configuring the KT-400 Ethernet Four-Door Controller with the Web Configuration Page” on page 31 for further details.
- **KT-Finder:** The KT-Finder is a stand-alone application that can be used to verify and configure the IP settings of the following Kantech devices: the KT-400 Ethernet Four-Door Controller, the KT-NCC, KTES and the Kantech IP Link. The Kantech device can be located within the same LAN or in a remote location over the internet. Refer to the procedure “Configuring the KT-400 Ethernet Four-Door Controller with the KT-Finder” on page 32 for further details.

## Four on-board doors

The KT-400 Ethernet Four-Door Controller is a full 4 onboard doors access controller. See **Figure 1** for a description of the PCB and **Figure 2** for all the connection possibilities offered by the KT-400 Ethernet Four-Door Controller.

## Communication ports

- 1 10/100Base-T (ETH1) Ethernet for network connection with the EntraPass Gateway.
- 1 10/100Base-T (ETH2) Ethernet for network connection with intelligent IP peripherals.
- 1 RS-232 for communication with EntraPass.
- 1 RS-485 (COM1) for communication with EntraPass or loop of controllers.
- 1 RS-485 (COM2) for RS-485 communication between the KT-400 and RS-485 modules.
- 1 SPI for communication with SPI modules.
- 1 USB 2.0 Host.

**Note:** You can connect a loop of KT-200 controllers on the RS-485 of the KT-400 if not mixed with other controllers (Kantech KT-100, KT-300 and KT-400).

**Note:** The **10/100Base-T (ETH2)**, **RS-485 (COM2)** and **USB 2.0 Host** communication ports are to be used ONLY on upcoming versions of the KT-400 controller.

## IP connectivity

The KT-400 Ethernet Four-Door Controller, when used with EntraPass Special Edition or a Multi-Site Gateway, can report events, gather its configuration through an IP connection over the LAN (Local Area Network) and over the Internet for a WAN (Wide Area Network). In this mode, the 1st or local controller becomes a “Master Controller” and can poll up to 31 Kantech controller(s). The KT-400 Ethernet Four-Door Controller is compatible with all the controllers. Unlike the other controllers, the KT-400 Ethernet Four-Door Controller asynchronously polls the controllers (KT-100, KT-200, KT-300) and communicates with the EntraPass Gateway only when necessary. This significantly reduces the amount of bandwidth required to operate your security system on the network.

- **AES Encryption 128-Bit:** The KT-400 Ethernet Four-Door Controller is extremely secure. It uses 128-bit AES encryption to communicate with the Gateway which prevents any hacking from the internet and ensures secure communications when used over the internet on a wide area network (WAN).

## Inputs

There are 16 onboard inputs on the KT-400 Ethernet Four-Door Controller. Up to 240 more can be added through the addition of expansion modules, such as the KT-MOD-INP16, for a total of 256 inputs. If using the KT-MOD-INP16 input module as double end of line resistor, there is a 128 inputs limitation. Each input can be individually configured for one of the following application:

- Door contact (4 onboard)
- T.Rex (Request to Exit Detector) (4 onboard)
- Interlock (4 onboard)
- Floor Selection for Elevator Application
- Elevator Action
- External Alarm System Status (Armed / Disarmed)
- External Alarm System Alarm (Alarm / Secure)
- External Alarm System Zones
- Relays to trigger on each input in alarm event
- Zone shunt: Single or group of zones can be permanently or temporarily 'shunted' to a secure state on the same controller. Shunt method includes:
  - Zone Shunt by another Zone - When a zone in alarm is programmed to shunt another zone / group of zones.
  - Zone Shunt on Unlock - When a zone is temporarily frozen to its actual state (alarm or secured) after an access granted.
  - Manual Shunt - Operator can manually 'Shunt' a zone to a secure state.
  - Disarmed Door Shunt - When alarm system is disarmed, some zones may be 'Shunted' to a secure state.
  - Entry / Exit Delay Shunt - When a user is in the process of disarming / arming the alarm system and entry / exit delay prevails, some zones may be 'Shunted' to a secure state.
- Arming / Disarming Request
- Postpone Arming Request
- Tamper switch input: The tamper switch is a non-programmable 'Fixed-Function' input. It is used to identify tampering of the KT-400 cabinet.

## Lock outputs

There are 4 onboard lock outputs and they are supervised. The locking function can also be performed by any onboard relay configured for this functionality.

## Relay outputs

There are 4 onboard relay outputs. Up to 256 relay outputs can be supported through the addition of expansion modules such as the KT-MOD-REL8.

## Reader outputs

There are 4 different possible outputs for each of the 4 onboard reader interfaces for a total of 16 programmable outputs. Reader outputs are used to give user visual and/or audible feedback on the ongoing access events.

## Reader interfaces

There are 4 onboard reader interfaces. They can be programmed for Wiegand or ABA (Clock and Data) readers.

## Elevator interface

The KT-400 Ethernet Four-Door Controller supports elevator interfacing with the addition of expansion modules such as the KT-MOD-REL8, KT-MOD-INP16 and KT-MOD-OUT16.

## Alarm panel interface

The KT-400 Ethernet Four-Door Controller supports alarm panel interfacing with the appropriate connections made between zone inputs, relay outputs and the alarm system panel.

## Automatic port detection

The KT-400 Ethernet Four-Door Controller automatically detects the site communication speed set by EntraPass as well as the communication port which can be IP (ETHERNET #1), RS-485 (COM1) or RS-232 (COM3).

## Downloadable firmware

The firmware program can be downloaded from any EntraPass workstation to the KT-400 Ethernet Four-Door Controller. The firmware program, stored in the controller's flash memory, is upgraded without having to change any parts.

**Note:** For KT-400 Rev.1, the firmware upgrade can be performed from EP 5.01 and higher.

## Trouble and reporting

The KT-400 Ethernet Four-Door Controller constantly supervises ac power and battery condition and reports "AC Lost", "Normal Battery", "Low Battery", "Battery Critical" or "No Battery", status to the EntraPass system. Power outputs are supervised and electronically protected against short-circuits and surges. Locking devices are also supervised for short and open circuits.

## Visual status indicators (LEDs)

The KT-400 Ethernet Four-Door Controller has multiple status indicators such as for troubleshooting, network activity, power status and outputs activity. See Figure 1 for their locations.

- **Heartbeat (BLUE):** The Heartbeat blue LED indicates the communication status with EntraPass or the IP mode of the controller. Refer to Table 1 for a descriptions of the heartbeat patterns.
- **Diagnostic (RED):** The DIAG red LED is for factory diagnostics and should never be seen on otherwise.
- **SPI Active (YELLOW):** This LED signals activity on the SPI expansion port.
- **COM1-RX, COM1-TX, COM2-RX, COM2-TX, RS232-RX and RS232-TX (YELLOW):** The six serial port LEDs are transmit/receive activity indicators.
- **LOCK1, LOCK2, LOCK3 and LOCK4 (RED):** Each lock output (Open Drain) has an indicator which turns on each time the corresponding output is activated.
- **RELAY1, RELAY2, RELAY3 and RELAY4 (RED):** Each relay output has an indicator which turns on each time the corresponding relay is activated.
- **AC PWR and DC PWR (GREEN):** The AC PWR LED is ON when AC power is present. The DC PWR is ON when the DC level is insufficient for all DC terminals such as the 12V AUX. For further details, see Troubleshooting on page 28 section.
- **ETH1, ETH2 LINK (GREEN):** The LED is OFF when there is no Ethernet network or the cable is disconnected, and ON when there is an Ethernet cable and network connection.
- **ETH1, ETH2 TXRX (YELLOW):** The LED indicates network activity

## Built-in SPI expansion

The KT-400 Ethernet Four-Door Controller allows connection of expansion modules in order to add outputs, like relays and open drain outputs, and inputs. See Figure 10 and Figure 11 for an example with expansion modules.

- **KT-MOD-REL8:** The KT-MOD-REL8 is an 8-relay expansion module. Each relay is 3 Amps, 30 VDC Form C. The module supports daisy-chaining which can add up to 32 KT-MOD-REL8 modules for a total of 256 relay outputs per KT-400 Ethernet Four-Door Controller.
- **KT-MOD-INP16:** The KT-MOD-INP16 is a 16-zone input expansion module. The module supports daisy-chaining which can add up to 15 KT-MOD-INP16 for a total of 240 external inputs per KT-400 Ethernet Four-Door Controller. The KT-400 Ethernet Four-Door Controller has 16 onboard inputs which gives a total of 256 inputs per controller.
- **KT-MOD-OUT16:** The KT-MOD-OUT16 is a 16-output expansion module. Each output is capable of 750 mA. It gives the opportunity to address the need for external LED, lock, relay, piezo and buzzer control. The module supports daisy-chaining which can add up to 16 KT-MOD-OUT16 modules for a total of 256 external open drain outputs per KT-400 Ethernet Four-Door Controller.

**Note:** The expansion modules support daisy chaining which can add up to 32 KT-MOD-REL8 modules for a total of 256 external relays per KT-400 Ethernet Four-Door Controller. Combining input and output expansion modules gives the flexibility to connect up to 256 inputs and 256 outputs. For external power supply requirements please see "Electrical Specifications" on page 21.



Figure 2: KT-400 Ethernet Four-Door Controller Inputs and Outputs View

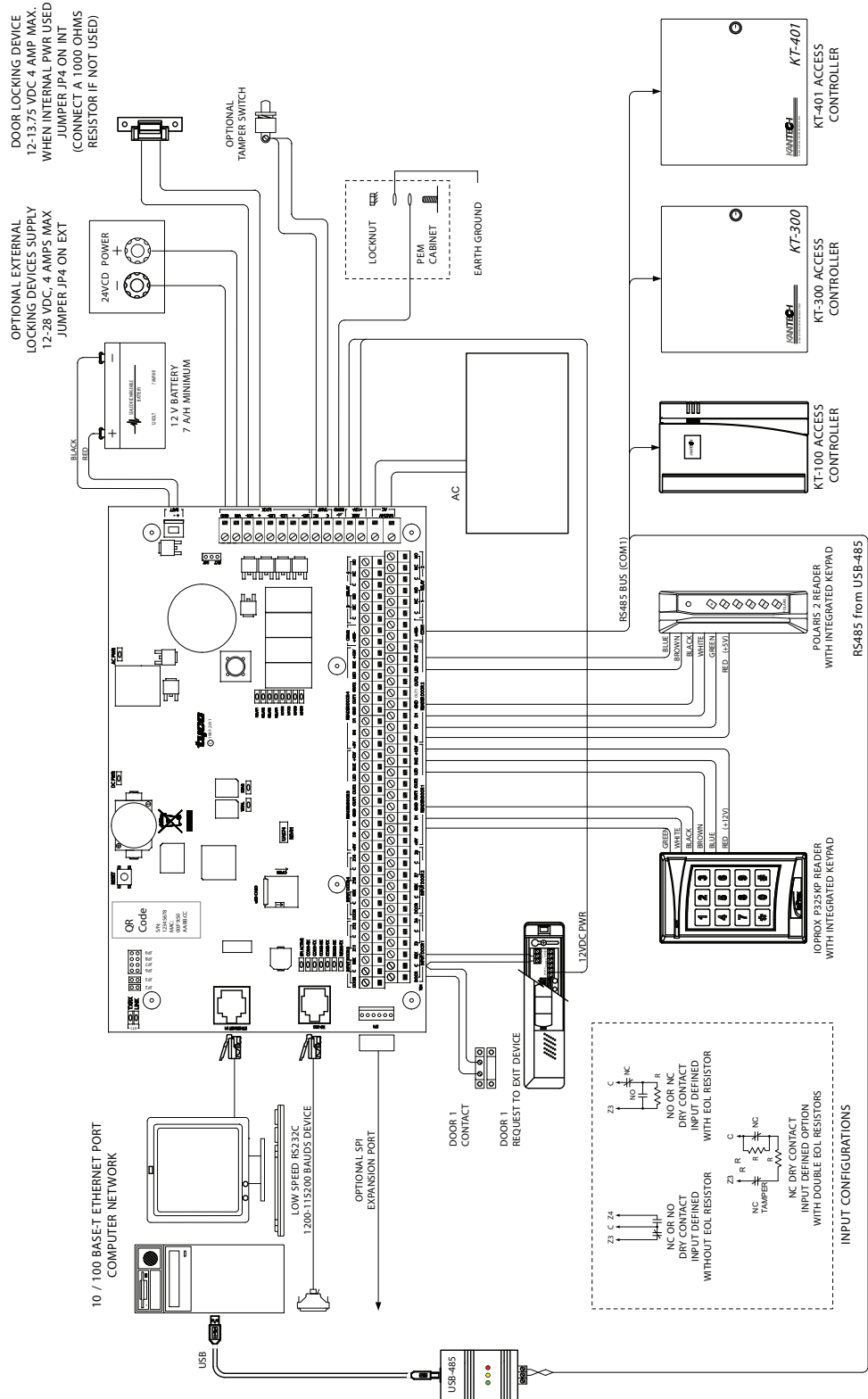
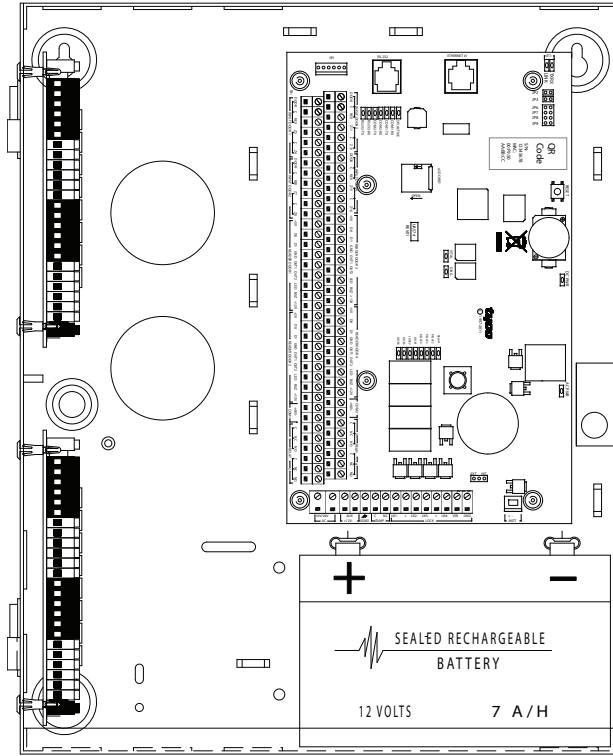
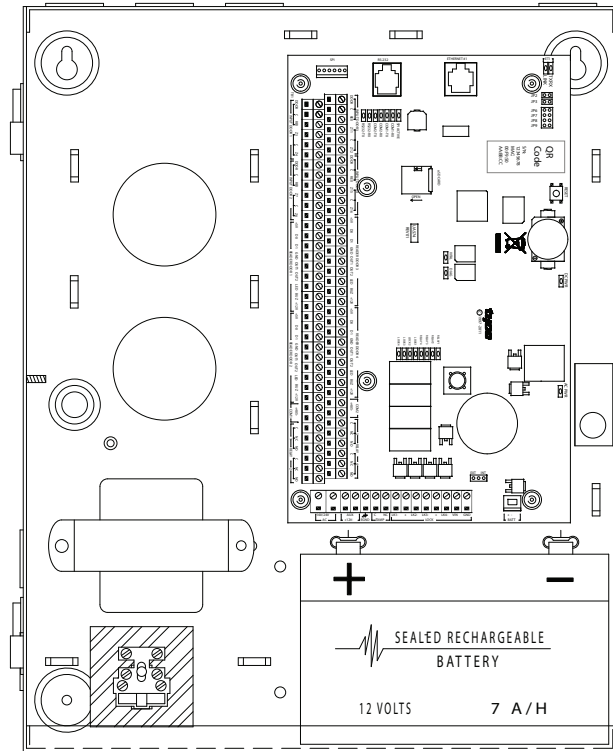

Figure 3: KT-400 Cabinet Models for North America and European Union

### KT-400 Cabinet with Optional Expansion Modules (2 max.) and Optional Battery



### KT-400 EU Cabinet for European Union





## System architecture

The KT-400 Ethernet Four-Door Controller can be used through various site applications with EntraPass Special, Corporate and Global Editions.

Applications with EntraPass Special and Corporate Editions with Multi-site Gateway.

- Over the internet. **See Figure 4.**
- Over RS-485 with a USB-485. **See Figure 5.**

Application with EntraPass Global Edition and a Global Gateway.

- Over RS-485 with a VC-485. **See Figure 6.**

Application with EntraPass Global Edition and a KT-NCC.

- Over the Internet with a KT-NCC. **See Figure 7.**

Application with EntraPass Special, Corporate and Global Editions.

- Over RS-232 straight from EntraPass RS-232 COM port. **See Figure 8.**

Figure 4: Over the Internet with EntraPass Special and Corporate Editions with Multi-site Gateway

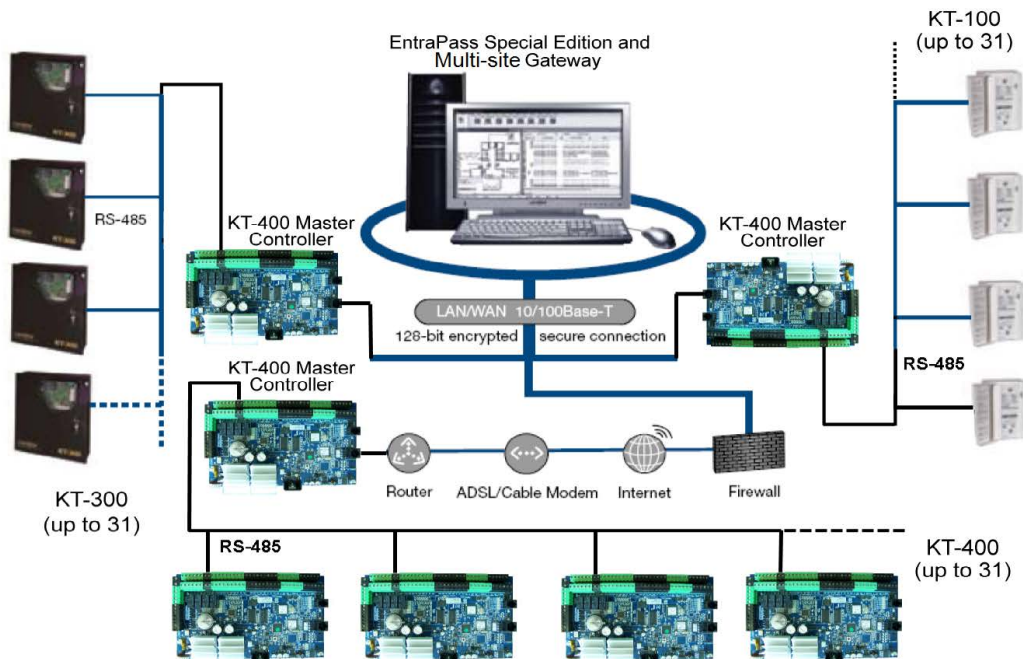

Figure 5: USB-485 with EntraPass Special and Corporate Editions with Multi-site Gateway

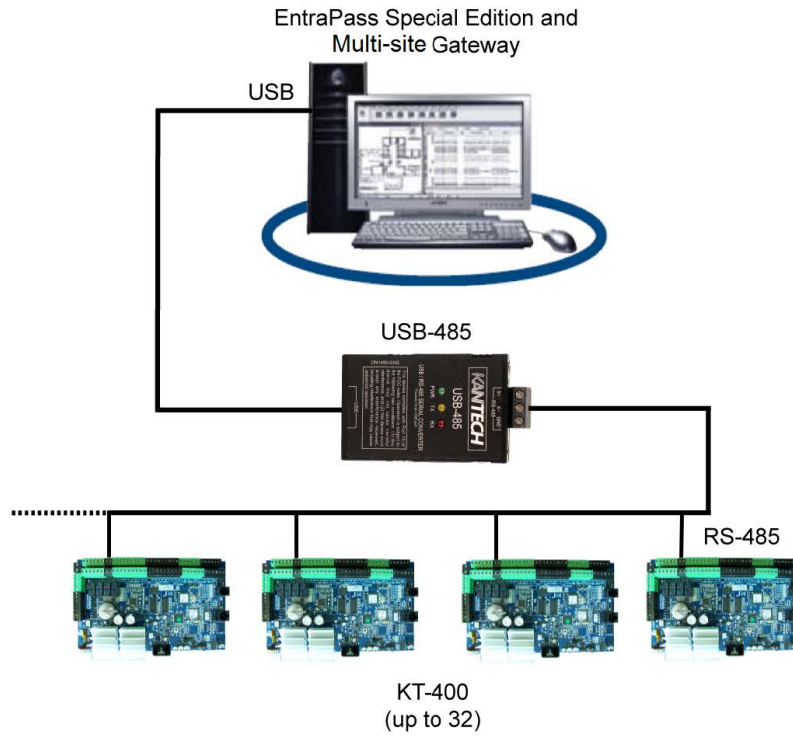
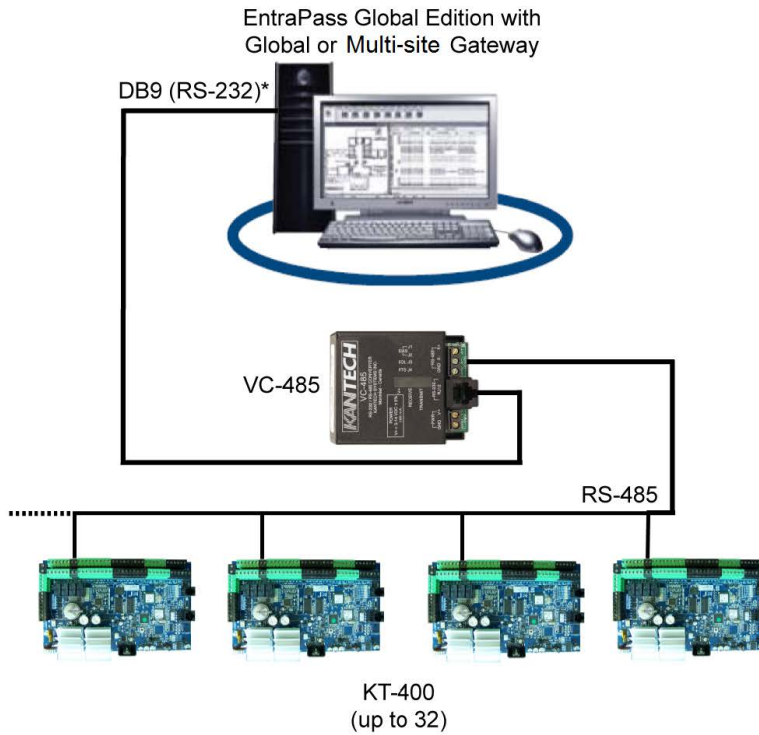

Figure 6: VC-485 with EntraPass Global Edition and Global or Multi-site Gateway



\*Use the DB9F to RJ-12 adaptor (740-1022) included in the VC-485 kit.

Figure 7: Over the Internet with a KT-NCC and EntraPass Global Edition

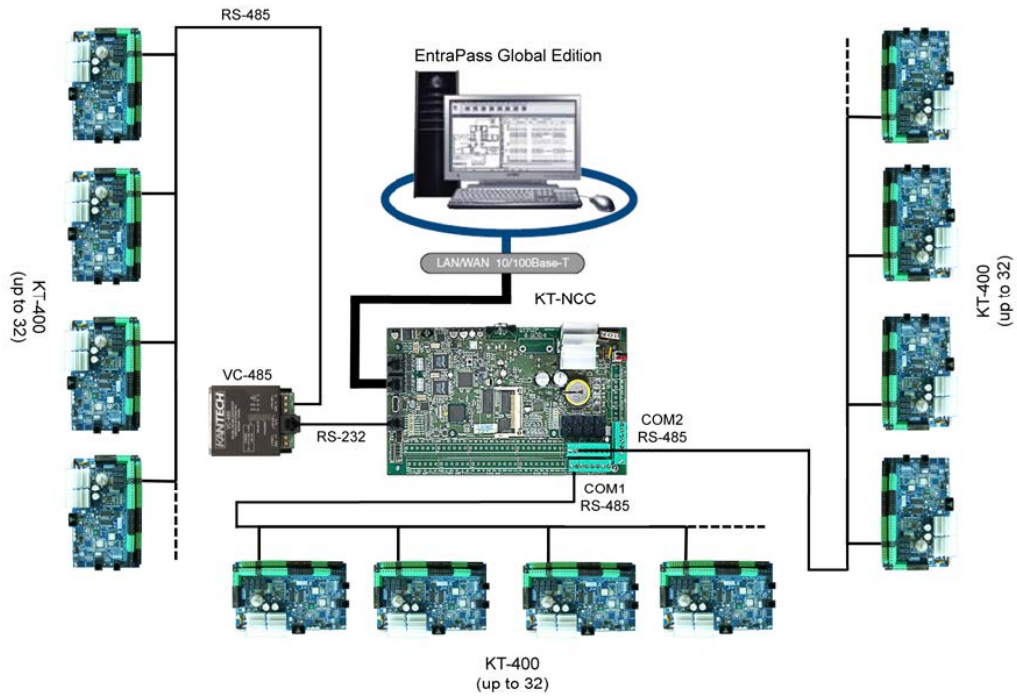
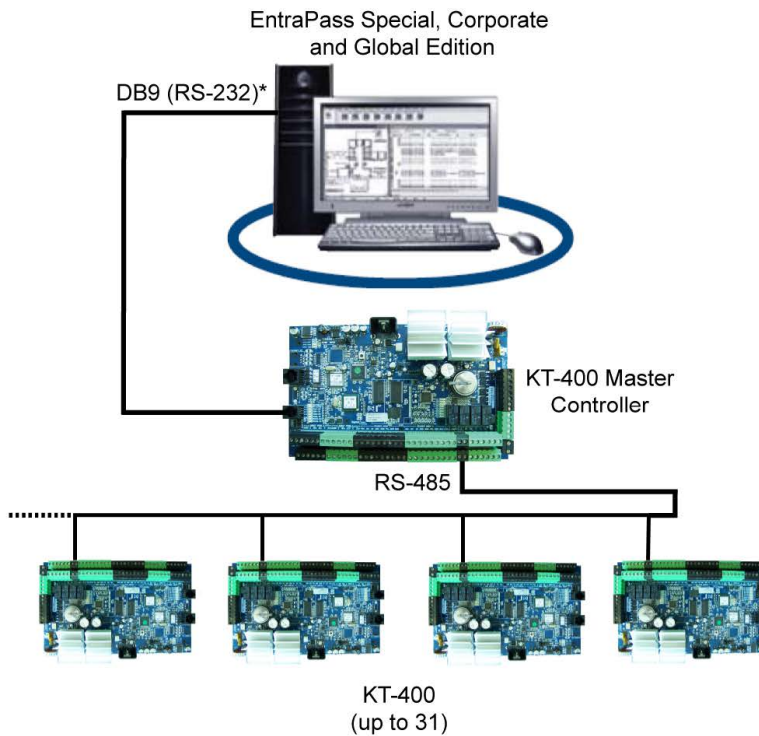

Figure 8: Over RS-232 straight from the EntraPass RS-232 COM port











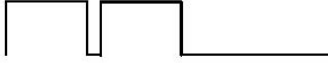
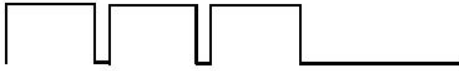

\*Use the DB9F to RJ-12 adaptor (740-1023) included in the CBLK-10 kit. The maximum length for the RS-232 cable is 30 m (100 ft).

## Heartbeat LED patterns

Communication status and other vital controller parameters can be obtained from heartbeat LED patterns. It is located near the center of the board, see **Figure 1**. This information is particularly useful when connecting the controller to the rest of the EntraPass system. The following table lists all conditions along with a brief description. Refer to **Table 3**, if you must reset or change the communication mode of the KT-400 Ethernet Four-Door Controller.

*Table 1: Heartbeat LED Patterns*

	—————	
Booting up		Steady
Factory default DHCP		Continuous LONG pulses
Unable to resolve DNS		2 LONG pulses
Forced default static		3 LONG pulses
DHCP server failed		4 LONG pulses
Receive broadcast		Single 2.5 sec.burst
Card read or swipe		Single 0.5 sec burst, resume previous flash
Hard reset		4 SHORT pulses
Multi-site gateway		3 SHORT pulses
Global gateway		1 SHORT pulse
Fail soft		Continuous SHORT pulses
Firmware update		5 pulses/sec @ 50% duty cycle
Rebooting		10pulses/sec @ 50% duty cycle

## Technical specifications

Type	Description
AC Power input (KT-400)	Transformer class 2, 120 VAC 75VA IN; 16 or 24 VAC OUT
AC Power input (KT-400-EU)	Transformer 230 VAC 50 Hz 100 VA IN, 16.5 VAC OUT
Optional DC Power Input (KT-400)	Laptop Power Supply, 110-230 VAC IN, 19-24 VDC OUT, 90-120 W
Battery back-up (KT-BATT-12)	12 VDC, 12 Ah battery is recommended when using electromagnet door lock
Operating Temperatures	For UL listed installations: 0°C to 49°C (32°F to 120°F) indoor use only For EN50133 compliant installations: 5°C to 40°C (41°F to 104°F) indoor Group I
Humidity Level	93% max. (relative humidity non-condensing)
Cabinet Dimensions (High-Wide-Deep)	37.59 cm (14.8 in) x 30.48 cm (12.0 in) x 12.57 cm (4.95 in)
Cabinet Weight (KT-400)	4.0 kg (8.82 lb)
Cabinet Weight (KT-400-EU)	7.0 kg (15.43 lb)
PCB dimension	23.11cm (9.1in) x 13.97cm (5.5in) x 4.06cm (1.6in)
Reader types	Wiegand, proximity, ABA Clock and Data, bar code, magnetic, integrated keypad, smartcard and others
Reader power output	12 VDC and 5 VDC @ 1A max each, protected and supervised
Monitored points (zone inputs)	16 monitored points (Z1 to Z16), NO/NC, without EOL (DRY), single EOL, double EOL and 1 fixed-function tamper switch input
Points maximum wiring	AWG #22 - 600 m (2,000 ft)
Door strike power supervised	<ul style="list-style-type: none"> <li>• 500 mA each or 2.0 Amps total for the KT-400 model (JP4 on INT)</li> <li>• 1 A each or 4.0 Amps total for the KT-400 model (JP4 on EXT)</li> <li>• 750 mA each or 3.0 Amps total for the KT-400-EU model (JP4 on INT)</li> </ul>
Auxiliary reader outputs	LEDs (LED, OUT1 and OUT2) and buzzer (BUZ) for each individual door, 25mA max each, open collector outputs
Relay controlled output	4 onboard Form C Relay controlled outputs, 30 VDC, 3 Amps max each
Communication ports	1 x RS-232 with RJ-12, 2 x RS-485, 2 x Ethernet 10/100 Base-T with RJ-45
Expansion port	1 x SPI 6-pin connector, bidirectional data exchange supported. Supplies 12 VDC, 500 mA max shared with 12 VDC Auxiliary port
Auxiliary power	1 x Auxiliary 12 VDC, 500 mA maximum shared with SPI expansion port
Communication speed	- 1200 to 115200 Bauds (automatic detection) over RS-232 and RS-485 - 10/100 Mb/s BaseT over Ethernet
Flash memory	256 MB NAND flash for application, storage and stand-alone event buffer holding 20,000 events
RAM memory	128 MB DDR2 for application loading and running
Network autonomy	Distributed data and processing
Certifications/listing	EN50133-1, EN55022, EN60950-1, EN61000-6-1, EN61000-6-2 FCC: Part15/ICES Class A UL 294, UL 1076, C-Tick
<p><b>Note 1:</b> The KT-400 is capable of restarting automatically after total power loss and will keep the programming for more than 120 hours of power interruption. The design is using flash memory for saving access rules. This is certified by Telefication under the requirements of EN50133-1, Recognition Class 0-3, Access Class A/B, Environmental Class II.</p> <p><b>Note 2:</b> For UL294 compliance, relay 1 is assigned to AC power loss and the KT-ACPW-LED must be attached to it accordingly.</p>	

## Electrical specifications

AUXILIARY READER OUTPUTS	MAXIMUM CURRENT (Typical)	COMBINED MAXIMUM CURRENT
LEDs (LED, OUT1 and OUT2) for each door reader	25 mA (each)	3.0 Amps for KT-400
Buzzer (BUZ) for each door reader	25 mA (each)	
OUTPUTS	MAXIMUM CURRENT	
1 for 12 VDC Auxiliary Power (11.2 to 13.75 VDC) polyswitch protected, shared with SPI expansion port	500 mA	4.0 Amps for KT-400 EU
4 for Controlled Readers (11.2 to 13.75 VDC)	1.0 A	5.0 Amps with optional
4 for Controlled Readers 5 VDC	1.0 A	KT-PS-240 laptop power supply
4 for Locks (11.2 to 13.75 VDC) when jumper JP4 is on INT (internal)	2.0 Amps for KT-400 3.0 Amps for KT-400EU 4.0 Amps with optional KT-PS-240 laptop power supply	
4 for Locks (12 to 28 VDC) when jumper JP4 is on EXT (external)		4.0 Amps for <b>both models</b>

## KT-400 ethernet four-door controller models, expansion modules models, related documentation and miscellaneous items

Part number	Description
<b>KT-400 Ethernet Four-Door Controller Models</b>	
KT-400	KT-400 Ethernet Four-Door Controller, IP Ready with Accessory Kit in Metal Cabinet, see Table 2
KT-400-EU	KT-400 Ethernet Four-Door Controller, IP Ready with Accessory Kit in Metal Cabinet, European Union Model, see Table 2
KT-400-PCB	KT-400 Ethernet Four-Door Controller PCB only, IP Ready with Accessory Kit, see Table 2
KT-400-CAB	KT-400 Black Metal Cabinet with Lock and Keys, see Table 2
KT-400-CABEU	KT-400 Black Metal Cabinet with Lock and Keys, European Union Model, see Table 2
<b>Expansion Modules Models</b>	
KT-MOD-INP16	KT-400 Expansion Module 16-Zone Inputs with SPI Cable 41 cm (16 in)
KT-MOD-REL8	KT-400 Expansion Module 8-Relay with SPI Cable 41 cm (16 in)
KT-MOD-OUT16	KT-400 Expansion Module 16-Output with SPI Cable 41 cm (16 in)
KT-MOD-CAB	KT-400 Expansion Module Cabinet, Black, with SPI Cable 91 cm (36 in), Lock and Two Keys
KT-MOD-CABEU	KT-400 Expansion Module Cabinet, Black, with Electrical Parts, SPI Cable 91 cm (36 in), Lock and Two Keys, European Union Model
KT-MOD-SPI-16	KT-400 SPI Cable 41 cm (16 in) for SPI Interconnection within the Cabinet
KT-MOD-SPI-36	KT-400 SPI Cable 91 cm (36 in) for SPI Interconnection between Cabinets
<b>Related Documentation</b>	
DN1420	EntraPass Special Edition, Reference Manual - English version
DN1415	EntraPass Corporate Edition, Reference Manual - English version
DN1316	EntraPass Global Edition, Reference Manual - English version
DN1474	EntraPass Special Edition, Reference Manual - French version
DN1435	EntraPass Corporate Edition, Reference Manual - French version
DN1289	EntraPass Global Edition, Reference Manual - French version
DN1796	Networking Basics, Application Note, English version
<b>Dimensions Drawings</b>	
DN1791	KT-CAB3000LDR 71 cm (28 in) Cabinet Dimensions Drawing
DN1793	KT-CAB4000LDR 107 cm (42 in) Cabinet Dimensions Drawing
DN1846	KT-400-PCB Dimensions Drawing
DN1848	KT-400-CAB Dimensions Drawing (UL Listed)
DN1850	KT-400-CABEU Dimensions Drawing (CE Compliant)

DN1851	KT-MP400 Mounting Plate Dimensions Drawing
DN1852	KT-MP500 Mounting Plate Dimensions Drawing
<b>Miscellaneous Items</b>	
CBLK-10	Cable kit, RS-232 cable 30 m (100 ft) with RJ-12 connectors for PC to master KT-400, 740-1023 (DB9F to RJ-12) adaptor and 740-1041 (DB9M to DB25F) adaptor
USB-485	USB-485 interface, USB cable 0.9 m (3 ft) and USB drivers on CD-ROM
VC-485	VC-485 interface, RS-232 cable 3 m (10 ft) with RJ-12 connectors, 740-1012 (DB25F to RJ-12) adaptor, 740-1022 (DB9F to RJ-12) adaptor and 740-1033 (DB25M to RJ-12) adaptor
KT-3LED-PLATE	Three-color LED alarm indicator mounted on single plate
KT-ACPW-LED	AC power LED indicator
KT-LOCK	Keylock for cabinet with 2 keys
KT-SW1224	Internal Power Supply 12 VDC, 2 Amps, 24 Watts for KT-MOD Expansion Modules only
KT-SMP3	Internal Power Supply 12 VDC, 2.5 Amps, 30 Watts for KT-400-EU model only
KT-TAMPER	Tamper switch for cabinet
KT-400-CON	KT-400 removable terminal block spare kit
TR1675	Hammond BF2F Transformer Class 2 wire-in, 120 VAC IN; 16 VAC OUT, UL Listed.
TR2475	Hammond BF2G Transformer Class 2 wire-in, 120 VAC IN; 24 VAC OUT, UL Listed
TR16100-240V	Transformer, 230 VAC 50 Hz 100 VA IN; 16.5 VAC OUT, CE Compliant
KT-PS-120	Laptop power supply kit, 100-120VAC IN, 19VDC OUT, 120W
KT-PS-240	Laptop power supply kit, 100-240VAC IN, 19VDC OUT, 120W, includes EU outlet



## Models information

- **KT-400:** Cabinet with one KT-400 for North America, up to two expansion modules can be installed in the cabinet,
- **KT-400-PCB:** KT-400 with parts,
- **KT-400-ACC:** Accessory kit,
- **KT-400-CAB:** Cabinet only for North America,
- **KT-400-EU:** Cabinet with KT-400, transformer, power supply and fuse terminal block for European Union,
- **KT-400-CABEU:** Cabinet only for European Union.

Table 2: Bills of Material Models

Item Description	KT-400 (Notes 1, 2 & 4)	KT-400-PCB (Note 2)	KT-400-ACC	KT-400-CAB (Notes 1 & 4)	KT-400-EU (Notes 1, 2, 3, 4 & 5)	KT-400- CABEU (Notes 1 & 4)
KT-400 PCB	1	1	-	-	1	-
Cabinet	1	-	-	1	1	1
KT-400-ACC Accessory Kit	1	1	-	-	1	-
Ground wire (PCB to cabinet)	1	1	-	-	-	-
Ground wire (door to cabinet)	1	1	-	1	1	-
Tamper switch	1	-	-	-	1	-
Battery cable	1	1	-	-	1	-
Resistor 5.6K, 0.5W	-	-	32	-	-	-
Resistor 1K, 0.5W	-	-	4	-	-	-
Fuse terminal block	-	-	-	-	1	-
230 VAC 100 VA IN, 16.5 VAC OUT, Transformer	-	-	-	-	1	-
Inner door sticker for North America, DN2023, <b>Figure 14</b>	1	-	-	1	-	-
Inner door sticker for European Union, DN2024, <b>Figure 15</b>	-	-	-	-	1	1
Installation Manual DN2022 - French	1	1	-	-	1	-
Installation Manual DN2003 - English	1	1	-	-	1	-

**Note 1:** The **KT-400**, **KT-400-CAB**, **KT-400-EU** and **KT-400-CABEU** models also include the **KT-LOCK**.

**Note 2:** The **KT-400**, **KT-400-PCB** and **KT-400-EU** models also include screws and locknuts.

**Note 3:** The **KT-400-EU** model also includes additional screws and cables.

**Note 4:** Cabinet wall mounting requires four (4) screws. We recommend stainless steel Phillips tapping screws M4.2 x 32mm (#8 x 1.25") (Spaenaur ST-631P or equivalent). Drywall mounting must also use four (4) plastic anchors (Spaenaur EXS5 or equivalent; not included).

**Note 5:** A time-lag fuse of 630mA is included with the fuse block terminal. If replacement is needed, only use recommended type (250VA, 630mA, Time-lag, TUV or VDE approved, must meet EN60127-1/2/3).

## Installing the KT-400 Ethernet Four-Door Controller

### Preparing to Install the KT-400 Ethernet Four-Door Controller

#### Required to install KT-400 Ethernet Four-Door Controller

- For North America: AC transformer 120 VAC, 60 Hz IN; 16 or 24 VAC, 75 VA OUT; class 2 (not included), 75 VA transformer
- For EMEA (Europe, Middle East and Asia): AC transformer 230 VAC, 50 Hz IN, 100 VA OUT (included in **KT-400-EU**)
- For North America: KT-PS-120 laptop power supply, 100-240VAC, 19VDC OUT, 120W (optional; not included)
- For EMEA: KT-PS-240 laptop power supply, 100-240VAC, 19VDC OUT, 120W (optional; not included)
- One battery 12 VDC, 7 Ah (not included)
- A visual inspection should be made when unpacking the KT-400 Ethernet Four-Door Controller. Any missing item/part or damaged component should be reported immediately.

### Physical installation

#### Check for ideal indoor location

#### Stay away from electrical or communication devices

The KT-400 cabinet has been designed to be mounted on a wall without any additional enclosures. The cabinet is large enough to accommodate the battery backup supply and the necessary wiring connections for most applications. EMT (Electrical Metallic Tubing) conduit knockouts are provided in 1.9 cm (0.75 in) on all sides of the cabinet. The cabinet should be mounted indoors, in a secure location providing normal temperature and humidity, leaving 23 cm (8 in) clear space around all sides and a minimum of 33 cm (13 in) clear space in front of the cabinet. The location should be easily accessible for servicing the equipment and it is recommended that controllers be located close to the controlled doors.

Controllers must be located at a minimum distance of 2 m (6 ft) from any high voltage equipment or wiring and from electrical equipment susceptible of generating electrical interference, at a minimum distance of 1 m (3 ft) from telephone equipment or lines, and at a minimum of 8 m (25 ft) from any transmitting equipment. Physical access, using keys, on controlled doors must be provided so that the KT-400 Ethernet Four-Door Controller can easily be accessed for servicing in case of malfunction.

### Earth grounding

#### AWG #18 grounding wire to EGND

The KT-400 Ethernet Four-Door Controller uses high performance communication, proper grounding must be provided to ensure proper operation.

**Make an earth ground connection to the cabinet of the KT-400 Ethernet Four-Door Controller as per the requirements of your local electrical code. Wire the E-GND terminal on the KT-400 Ethernet Four-Door Controller printed circuit board directly to that connection point.**

### Door locking devices

#### Connect the door lock device to + and LK1-, (+ and LK2-), (+ and LK3-) or (+ and LK4-)

**Note:** If you need external power for **ALL** the external locks, you can use an external power supply. Connect the power supply to the **VIN** and **GND** terminals and put jumper JP4 on EXT.

**When jumper JP4 is on INT, the total maximum current draw is 2, 3 or 4 Amp, depending on the transformer main power 75 VA, 100 VA, or**

When jumper JP4 is on EXT, the total maximum current draw is 12 to 28 VDC, 4.0 Amps for all configurations with external power supply.

Check for local “magnetic lock” regulations

LK1-, LK2-, LK3- and LK4- and + terminals are located near the battery (BATT) terminals. The locking device outputs are controlled according to the end-user programmed parameters for allowing access to or unlocking doors according to schedules and access levels. These doors locking device outputs can operate DC powered locking devices such as electromechanical strikes and can be configured to operate fail-safe or fail-secure (normal or reverse action).

**Note:** If required, the KT-400 can provide galvanically isolated output(s) by programming any of the relays.

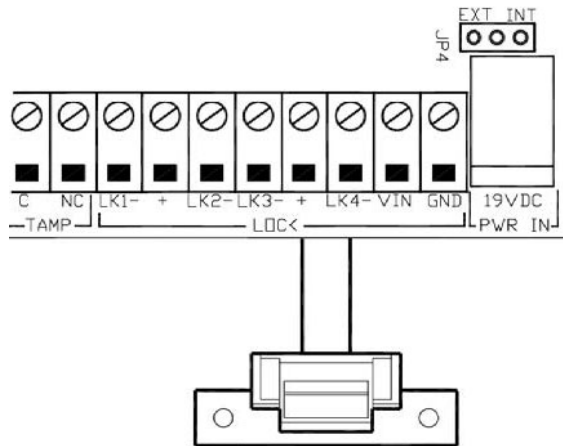

**Note:** Use 1 K ohm EOL (End-of-Line resistor) between + and LK- terminals if not used.

Warning: Controlled door locks may be governed by regulatory bodies and should always be installed according to local regulations. In most instances, there are strict limitations to installing fail-secure devices and fail-safe locking devices such as magnetic locks or other similar locking devices on doors used as emergency exits.

## Hooking up inputs

Connect devices to inputs 1 to 16

Resistors for all inputs 5.6K ohm (if selected)

The KT-400 has an on-board capability of monitoring 16 input points (expandable to 256 with expansion modules). Each onboard input is supervised with or without end-of-line resistors (5.6K ohm). The maximum distance of one line is 600 m (2,000 ft) with AWG #22 in a single or double EOL configuration.

**Note:** Onboard Inputs can be defined with: none, single or double EOL (End-of-Line) resistor(s) according to your EntraPass software settings.

Inputs 1-2 are automatically reserved for the first controlled door. The contact is assigned input 1 and the associated request-to-exit detector as input 2. Inputs 5 and 6 are automatically reserved for the second controlled door. The contact is assigned input 5 and the associated request-to-exit detector as input 6. Inputs 9 and 10 are automatically reserved for the third controlled door. Inputs 13 and 14 are automatically reserved for the fourth controlled door. There is no obligation to follow these rules but this standard convention facilitates servicing.

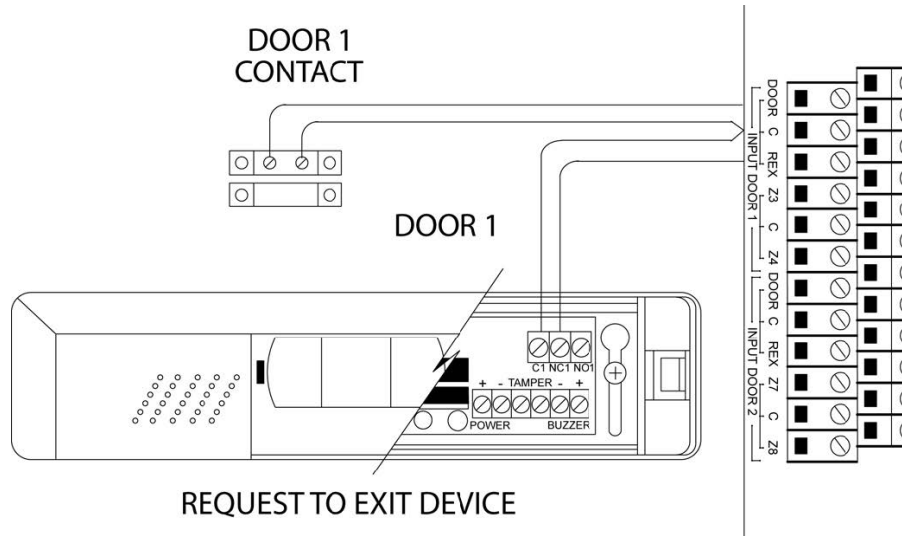

## □ Connect readers and keypads

### READER CONNECTION TERMINAL WARNING

Connecting the red wire lead (or power lead) of a 5 VDC reader to the 12 VDC terminal may damage the reader. See your reader installation procedure for proper power connection. Up to 4 readers can be connected to a KT-400. They can be installed on one door to control both entry and exit or on four separate doors operating independently to control oneway access. The distance between the readers and the KT-400 varies by reader type (please consult the installation manual for details). Auxiliary outputs provide visual and/or audible access operation feedback at the controlled door. Outputs “READER DOOR 1 - OUT1 OUT2 LED & BUZ” are used for the first door, “READER DOOR 2 - OUT1 OUT2 LED & BUZ” are used for the second door, “READER DOOR 3 - OUT1 OUT2 LED & BUZ” are used for the third door and “READER DOOR 4 - OUT1 OUT2 LED & BUZ” are used for the fourth door.

**Note:** For ioSmart RS-485 reader connection, please refer to the ioSmart installation manual.

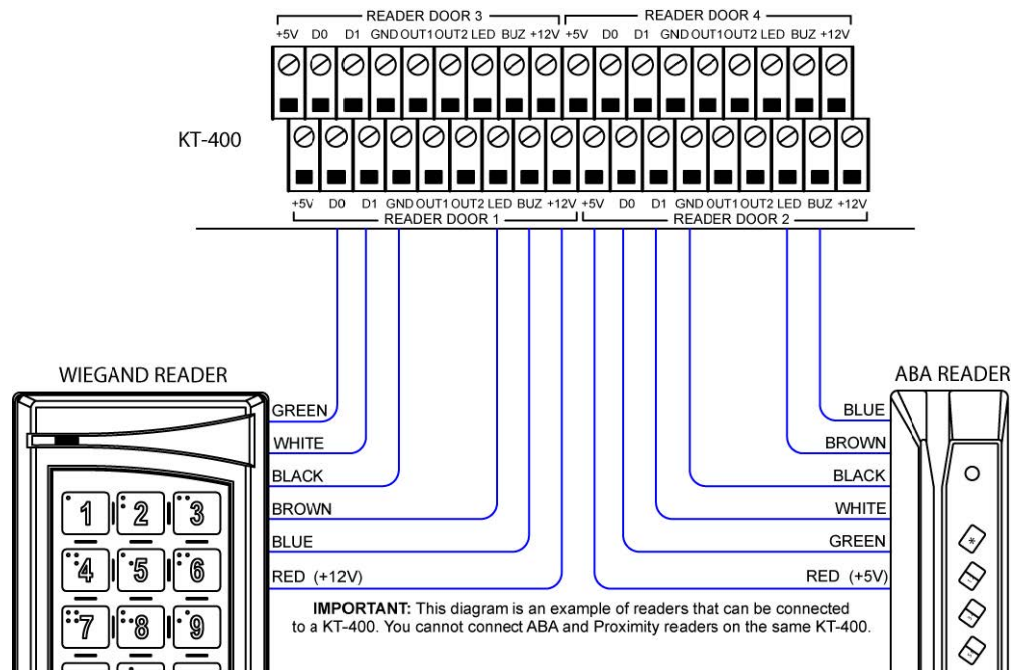

## Relay controlled outputs

The KT-400 provides four relay outputs RELAY1 to RELAY4 (3 Amps, 30 VAC/VDC). The KT-400 can be expanded up to 256 controlled outputs when using expansion modules.

- The KT-MOD-OUT16 module provides 16 outputs at a maximum of 750 mA per output.
- The KT-MOD-REL8 module provides 8 relay outputs at a maximum of 3 Amps per relay.

**Note:** Since the KT-400 maximum output current draw on the SPI expansion port is 500 mA when the 12V AUX terminals are not used, an external power supply of 12 VDC, 2 Amps is required when adding expansion modules to the same KT-400. See “SPI Expansion Port” on page 23 for additional details concerning the external power supply requirement for expansion modules.

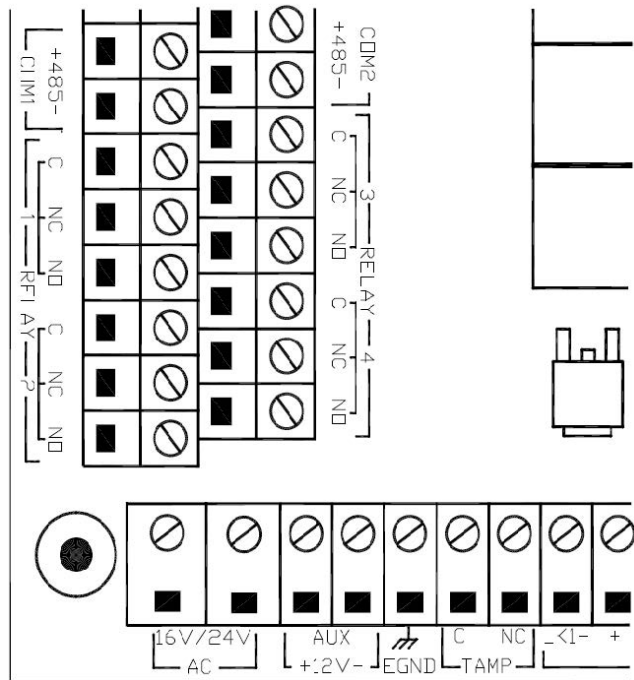

## Auxillary outputs

- Connect auxiliary outputs to readers and local warning devices

Auxiliary outputs are used for visual and audible signal. They can be activated according to input conditions or events and local alarms. Auxiliary outputs “READER DOOR 1 to 4 - LED” provide visual feedback of access operation, and auxiliary outputs “READER DOOR 1 to 4 - BUZ” can activate audible warning devices, such as T-REX or reader buzzer, to signal door alarms.

## Tamper protection

- Install tamper switch on cabinet

A tamper switch must be installed on the unit to detect unauthorized cabinet opening. The normally closed tamper switch must be connected to the dedicated tamper input, next to the EGND.

**Note:** The tamper switch is required for a UL listed installation.

## Connecting the KT-400 Ethernet Four-Door Controller

### Connecting the VC-485 or the USB-485 to the RS-485 Bus

- Connect the RS-485 cable to (COM1) + 485 - and the RS-485 signal ground to the 12 VDC AUX - (negative)

Controllers are linked together through their RS-485 terminals. The maximum communication loop length is 1.2 km (4,000 ft) using appropriate cabling. The RS-485 communication loop should be wired with Ethernet Category 3 double twisted pair network cable or better. The RS-485 loop can operate from 1200 to 115200 Bauds under normal conditions. Intermittent communication problems or erratic operation may require network speed drops to 9600 or 19200 Bauds. Varying the network speed does not perceptibly change the operation speed of the system.

**Note 1:** Most installations should be set to 38400 Bauds.

**Note 2:** Connecting several KT-400 at a single point is not recommended neither are splitters or spider web (star) networks.

**Note 3:** If the AUX 12 VDC - is already used, the RS-485 signal ground can be connected to the other GND terminals on the KT-400. The EGND (earth ground) terminal cannot be used for signal ground, only use the GND and AUX 12 VDC - (negative) terminals for signal ground.

**Note 4:** There is no end-of-line resistor to install on the RS-485 COM1 terminals on the last KT-400 controller of a loop.

**Note 5:** If you must make up your own RS-232 cable with a RJ-12 connector, refer to the following diagram for the RJ-12 pin-out.

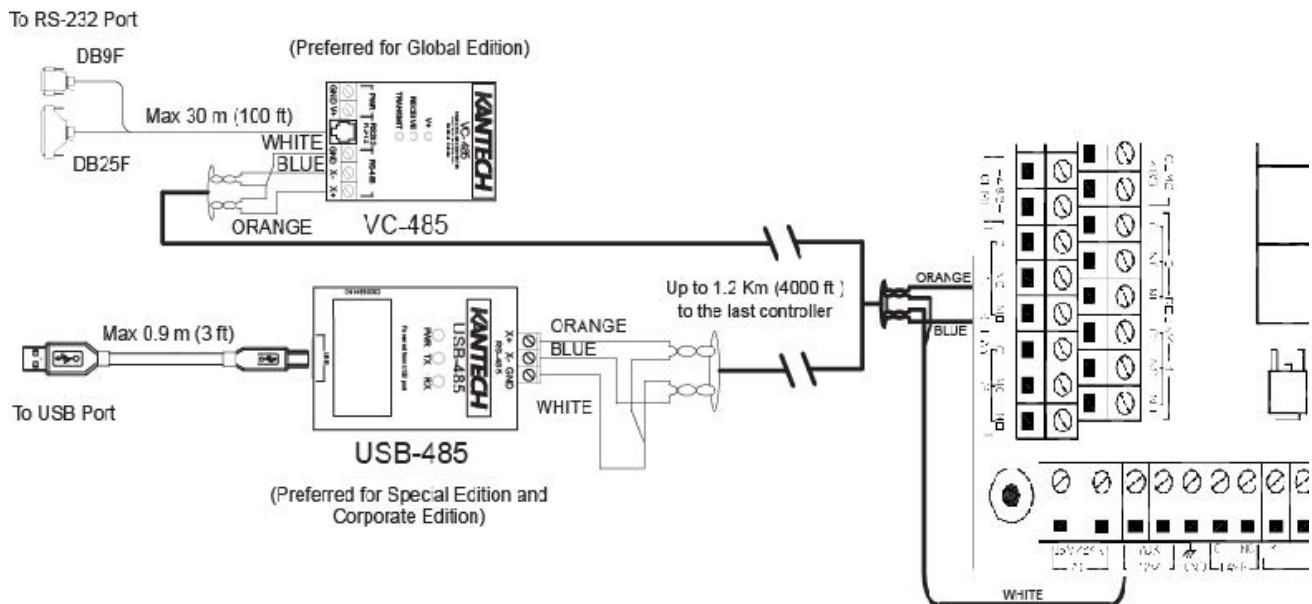

## Connecting the Master Controller to the Host PC via RS-232

- Connect RS-232 cable from KT-400 to the PC (maximum length 30 m (100 ft))

If the local master controller is located more than 30 m (100 ft) from the host computer, you must use a VC-485 or USB-485 interface.

**Note 1:** The CBLK-10 kit includes 30 m (100 ft) of RS-232 cable with RJ-12 connectors and the 740-1023 (DB9F to RJ-12) adaptor

**Note 2:** If you must make up your own RS-232 cable with RJ-12 connectors, refer to the following diagram for the RJ-12 pin-out.

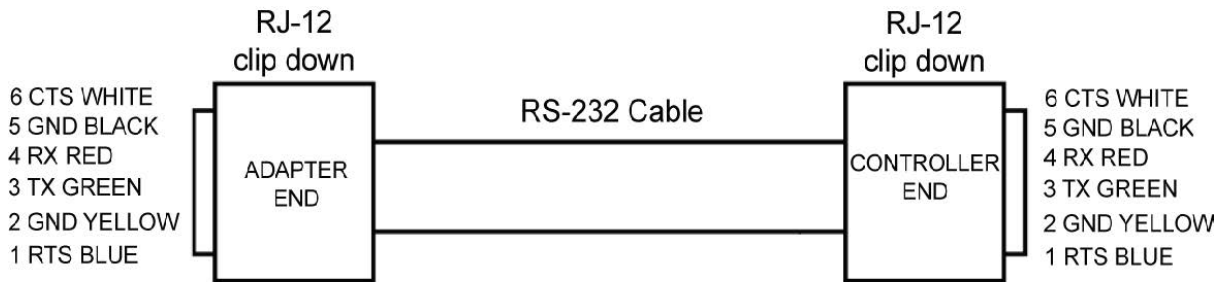
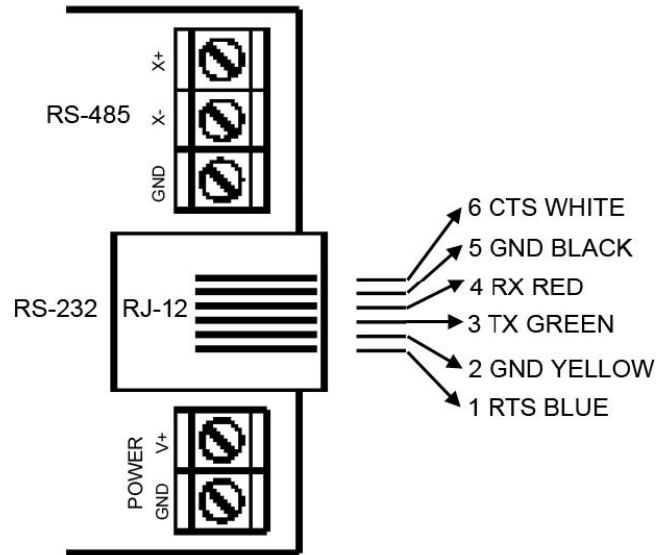

## Connecting over Corporate Network (LAN)

If the master controller is used in a LAN-enabled corporate setting, use the RJ-45 Ethernet port to connect the controller to the corporate network. This method uses existing wiring for data exchange between EntraPass and the controllers.





## SPI Expansion Port

The SPI (Serial Peripheral Interface) expansion port on the KT-400 is used to connect expansion modules, in order to add more inputs and outputs such as relays. The maximum current draw for the SPI expansion port is 500 mA when the 12V AUX terminals are not used. The 6-pin SPI cable must be connected to the SPI IN of the first module. See Figure 9 and Figure 11 for examples of interconnection between the KT-400 and expansion modules.

Figure 9: KT-400 Interconnection Examples with Expansion Modules

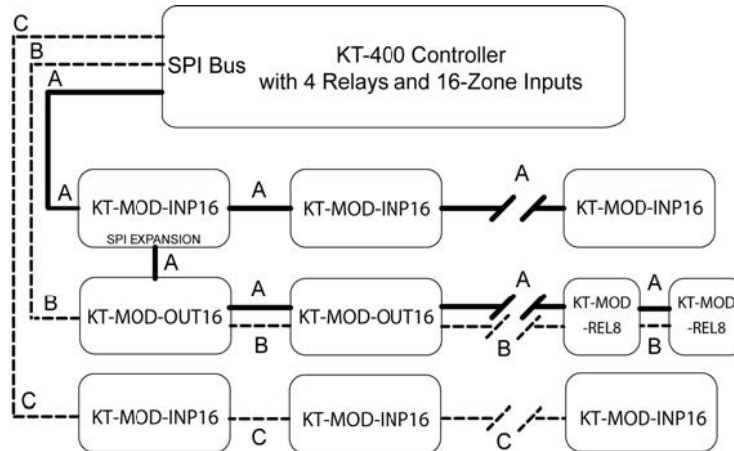

- 1- Use path A when combining input (KT-MOD-INP16) and output (KT-MOD-REL8 and KT-MOD-OUT16) modules. You must use the SPI expansion port (SPI EXP) of the 1st input module to add a group of output modules.
- 2- Use path B when connecting ONLY OUTPUT modules (KT-MOD-REL8 and KT-MOD-OUT16).
- 3- Use path C when connecting ONLY INPUT modules (KT-MOD-INP16).
- 4- The maximum number of inputs is 256 (16 x KT-MOD-INP16).
- 5- The maximum number of outputs is 256 (16 x KT-MOD-OUT16), (32 x KT-MOD-REL8) or any combination giving 256 outputs.
- 6- Maximum current draw must be planned, use external 12 VDC, 2 Amps power supply(ies) when required.

The number of expansion modules that can be connected to the KT-400 SPI expansion port, without an additional external power supply, can vary depending how much current is drawn from all the modules in the SPI chain.

Check the following table to calculate the SPI chain current draw:

EXPANSION MODULE	QTY OF MODULES X MAXIMUM CURRENT DRAW	TOTAL CURRENT
KT-MOD-REL8	_____ x 330 mA	_____ mA
KT-MOD-INP16	_____ x 40 mA	_____ mA
KT-MOD-OUT16	_____ x 750 mA	_____ mA
Maximum current draw from KT-400 SPI expansion port when the 12 VDC AUX terminals are not used.		- 500 mA
If the total current is between 0 mA and 1850 mA (1.85 Amps), 1 external power supply is required. If the total current is between 1851 mA and 3700 mA (3.70 Amps), 2 external power supplies are required.		

## Example of current draw calculation:

1. 15 modules (KT-MOD-OUT16) x 750 mA = 11250 mA
2. 11250 mA - 500 mA (or 0 mA if the 12 VDC AUX of the KT-400 is used) = 10750 mA
3. 10750 mA divided by 1850 mA = 5.8 which means in fact 6 external power supplies 12 VDC, 2 Amps are required.
4. Connect an external power supply at every expansion module where the current draw has reached 1.85 Amps.
5. Make sure the power jumper on the modules is in the correct position when using external power supply(ies).

## Important installation rules about expansion modules

**Note 1:** The maximum current draw must be calculate each time there is a new module added to the SPI chain.

**Rule 2:** The SPI cable, between the KT-400 and the 1st module or between each modules, cannot exceed 1 m (3 ft). Shielded wire should only be used in areas with excessive RF noise of electromagnetic interference. Keep in mind that the expansion modules must be defined in the EntraPass system when they are installed.

**Rule 3:** There is already 4 relays available on the KT-400 Ethernet Four-Door Controller. Don't forget to check the relays number assignments to prevent redundancy unless it has been planned on purpose.

For more details concerning the expansion modules, refer to the following documents:

Part number	Description
DN1775	KT-MOD-INP16 Install Sheet - French version
DN1776	KT-MOD-INP16 Install Sheet - English version
DN1780	KT-MOD-OUT16 Install Sheet - French version
DN1781	KT-MOD-OUT16 Install Sheet - English version
DN1785	KT-MOD-REL8 Install Sheet - French version
DN1786	KT-MOD-REL8 Install Sheet - English version
DN1805	KT-MOD-CAB Install Sheet - French version
DN1806	KT-MOD-CAB Install Sheet - English version
DN1833	KT-MOD-CABEU Install Sheet - French version
DN1834	KT-MOD-CABEU Install Sheet - English version
DN1790	KT-MOD-INP16, -OUT16 and -REL8 Expansion Modules Dimensions Drawing
DN1792	KT-MOD-CAB Dimensions Drawing
DN1794	KT-MOD-CABEU Dimensions Drawing
DN1795	KT-MP200 Mounting Plate for KT-MOD-INP16, -OUT16 and -REL8 Expansion Modules Dimensions Drawing

Figure 10: PCB View of Expansion Modules

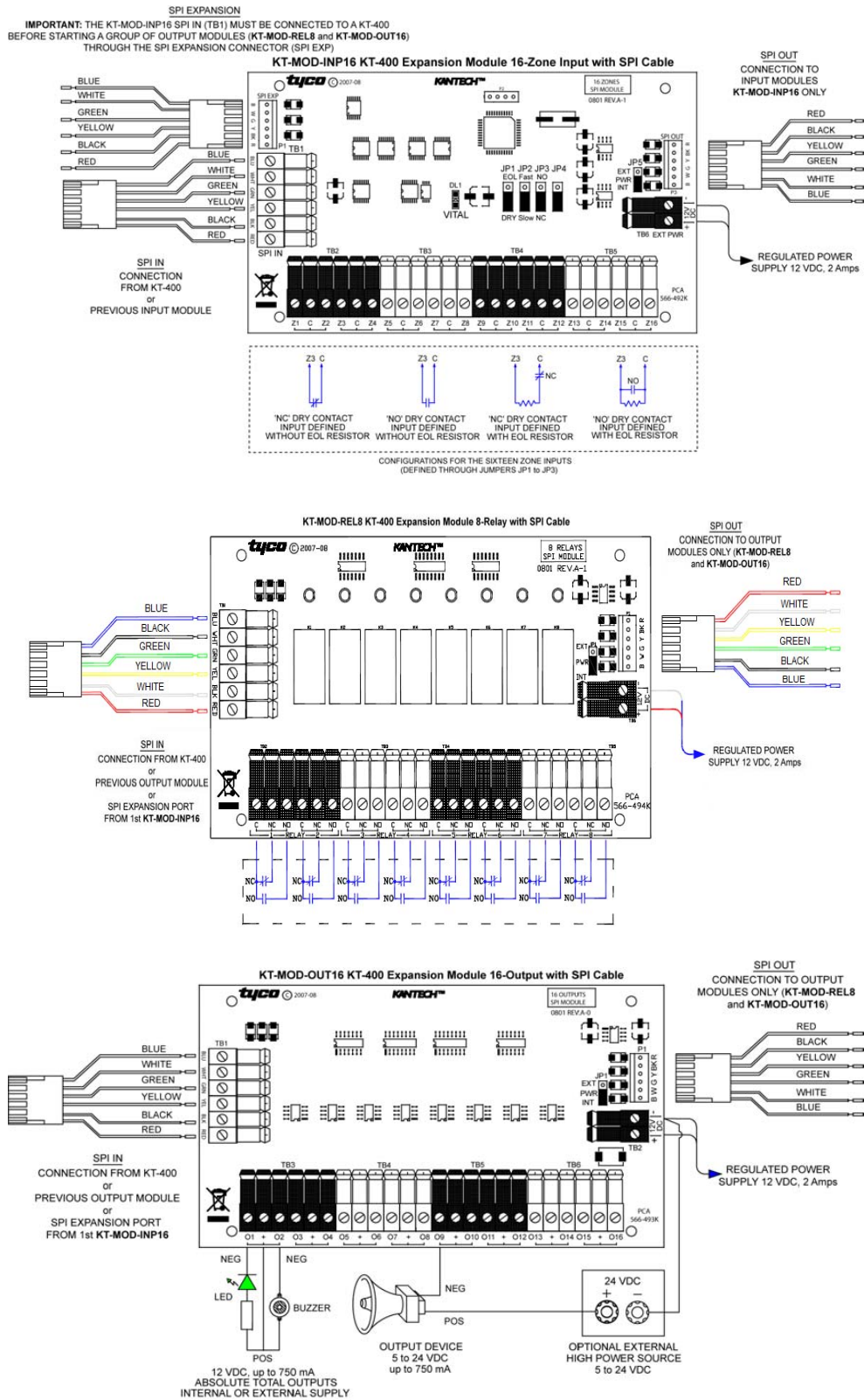

Figure 11: Example of KT-400 Ethernet Four-Door Controller Interconnection with Expansion Modules

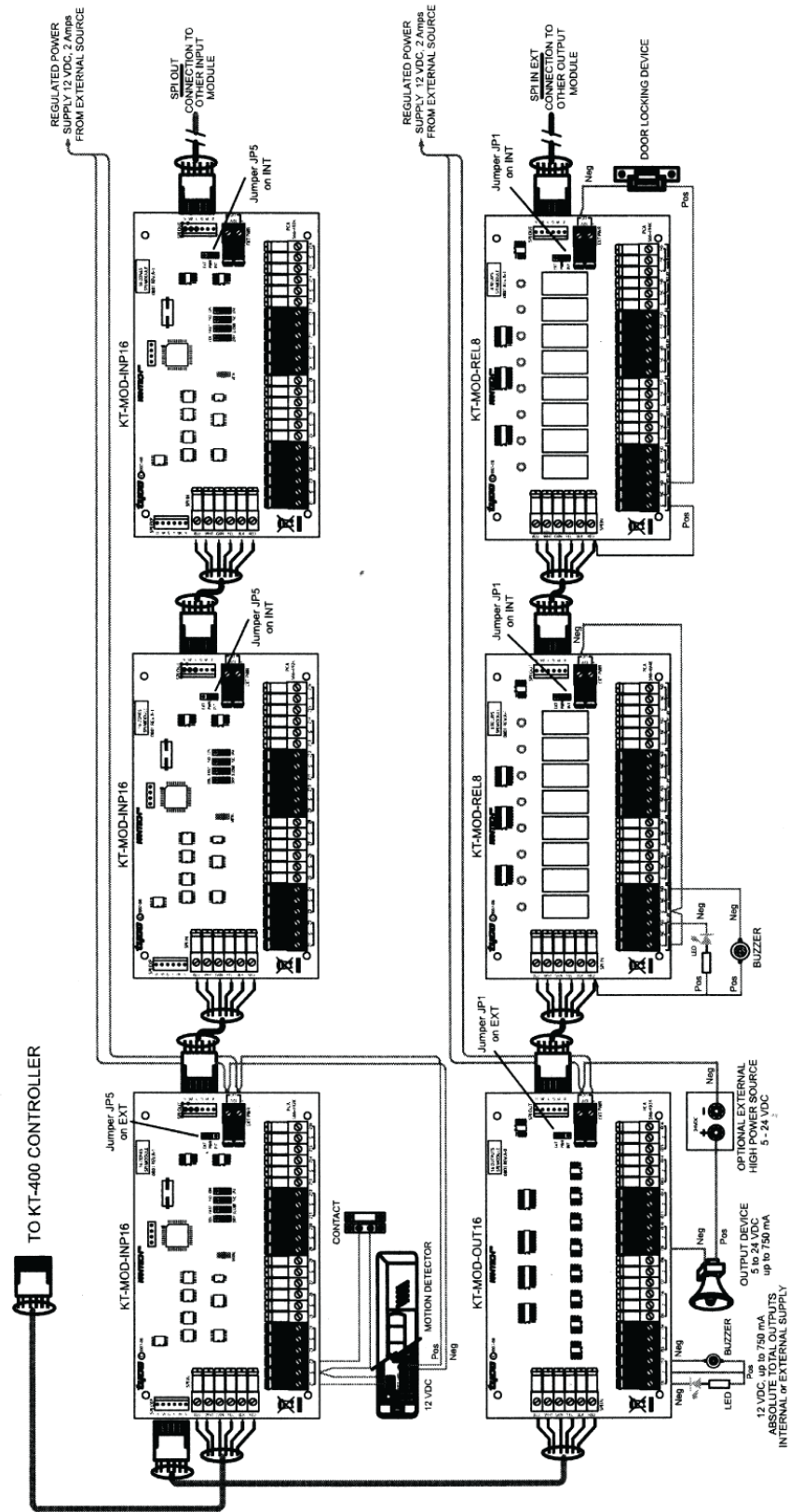
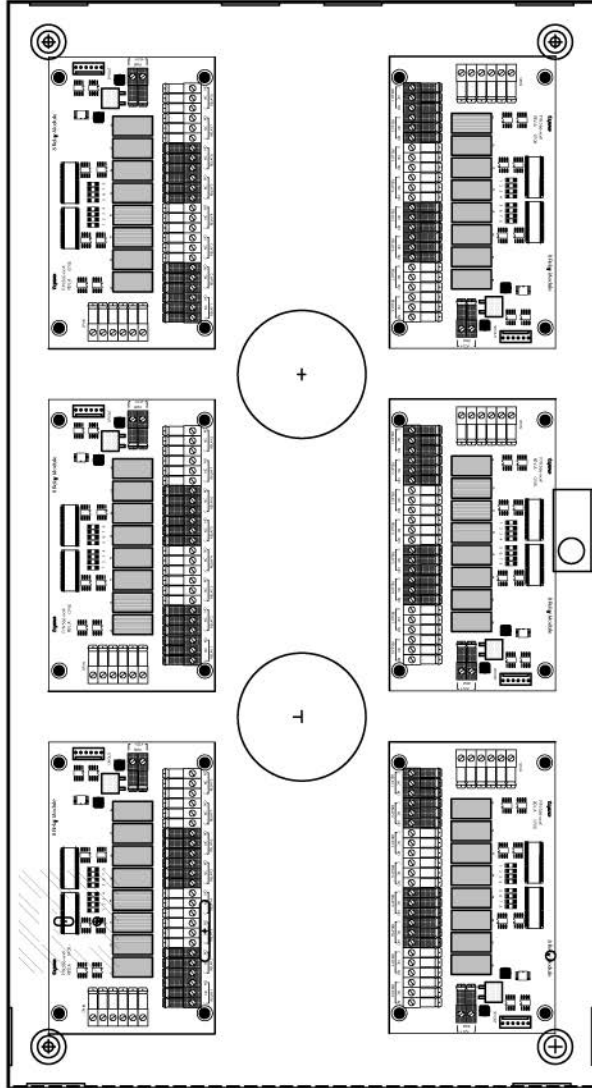
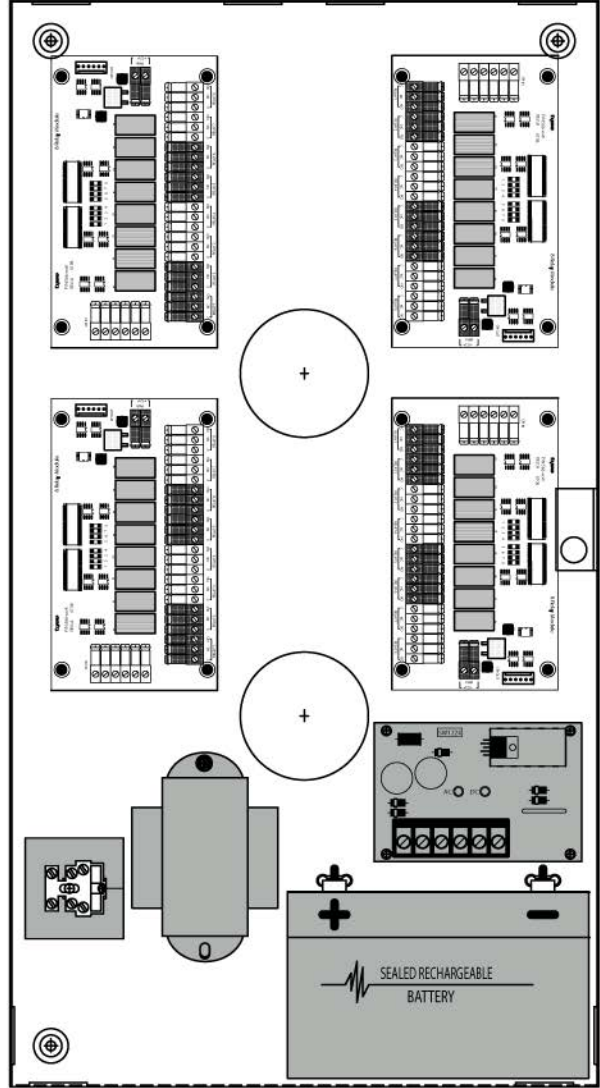

Figure 12: Expansion Modules Cabinets for North America and European Union

**KT-MOD-CAB for North America  
with Optional Expansion Modules (6 max)**



**KT-MOD-CABEU for European Union  
with Optional Expansion Modules (4 max)  
and Optional Power Equipment**



## Troubleshooting

Table 3: Reset Types and Descriptions













JUMPERS	HEARTBEATS PATTERNS	RESETS
JP2  JP3 	Continuous quick flashing 	<b>Soft Reset:</b> When JP2 and JP3 are ON, the controller will reset on a) power up, b) pushbutton, or c) EntraPass software 'Manual operator soft reset': <ul style="list-style-type: none"> <li>All controller's memory definitions and parameters are verified and kept intact if still valid.</li> <li>With a corporate gateway, the internal event buffer is maintained if still valid.</li> <li>With a global gateway, the internal event buffer is cleared.</li> <li>IP address is kept if valid.</li> <li>Controller generates the appropriate message: a) 'Power ON Soft Reset' b) 'Manual Pushbutton Soft Reset' c) 'Operator Soft Reset'.</li> </ul>
JP2  JP3 	3 short pulses 	<b>Hard Reset:</b> When JP2 is OFF and JP3 is ON: <ul style="list-style-type: none"> <li>All controller's memory is settled to default values.</li> <li>Internal event buffer is cleared.</li> <li>IP address is kept if valid.</li> <li>Controller generates the message, 'Controller Hard Reset'.</li> <li>Internal RTC (Real Time Clock) and clock are settled to the default time and date values January 1st 2005, 00:00:00, Saturday.</li> </ul>
JP2  JP3 	3 long pulses 	<b>Forced Default Static:</b> When JP2 is ON and JP3 is OFF: <ul style="list-style-type: none"> <li>Same as 'Soft Reset' condition, except IP address is forced to the default static IP: 192.168.1.2.</li> </ul>
JP2  JP3 	Continuous long pulses 	<b>Factory Default DHCP:</b> When JP2 and JP3 are OFF: <ul style="list-style-type: none"> <li>All controller's memory is settled to default values.</li> <li>Internal event buffer is cleared.</li> <li>Controller generates the message 'Controller Factory Default Reset'.</li> <li>The Ethernet port reverts to DHCP configuration and waits for an IP address from the local DHCP server.</li> <li>Internal RTC and clock are settled to the default time and date values January 1st 2005, 00:00:00, Saturday.</li> </ul>

Table 4: AC and DC Power LED Status Indicators

AC Power LED	DC Power LED	Status Indicators
ON	ON	<ul style="list-style-type: none"> <li>The AC power is present.</li> <li>The DC power level is sufficient for all DC operations such as the readers, outputs and the 12V AUX.</li> </ul>
ON	OFF	<ul style="list-style-type: none"> <li>The AC power is below minimum requirements, and</li> <li>the 12V rechargeable backup battery is either not connected, or</li> <li>its voltage is below minimum requirements.</li> </ul>
OFF	ON	<ul style="list-style-type: none"> <li>The KT-400 is running on the 12V rechargeable backup battery only.</li> </ul>

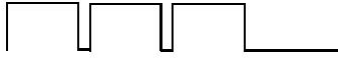
### Default initialization

The KT-400 default initialization or Factory Default DHCP is done at Kantech. The following steps should be followed only if:

- a. You want to configure the KT-400 with the KT-Finder, see page 33.
- b. The KT-400 was communicating via the RS-232 port and you have installed a VC-485 or USB-485 to communicate via the RS-485 port.
- c. The KT-400 was communicating via a VC-485 or a USB-485 interface and you want to communicate directly with the serial (RS-232) port.
- d. You are using a KT-400 from another site and there is no communication.

### How to reset the KT-400 Ethernet Four-Door Controller for Factory Default DHCP mode

Before you start:

- Locate the reset button, the two jumpers JP2 - JP3 and the blue Heartbeat LED.
  - The Ethernet cable must be connected to the corporate network. The green LINK LED should lit and the yellow TXRX LED should be flashing.
  - The blue Heartbeat LED should be flashing.
1. Remove JP2 and JP3 jumpers as described in Table 3 for Factory Default DHCP mode.
  2. Press the reset button.
  3. Check the blue Heartbeat LED heartbeat pattern.
  4. Verify the IP address with the KT-Finder, see page 33.
  5. Put back JP2 and JP3 jumpers.
  6. Configure the KT-400 with the KT-Finder, see page 33.

Figure 13: KT-400 Factory Default Steps

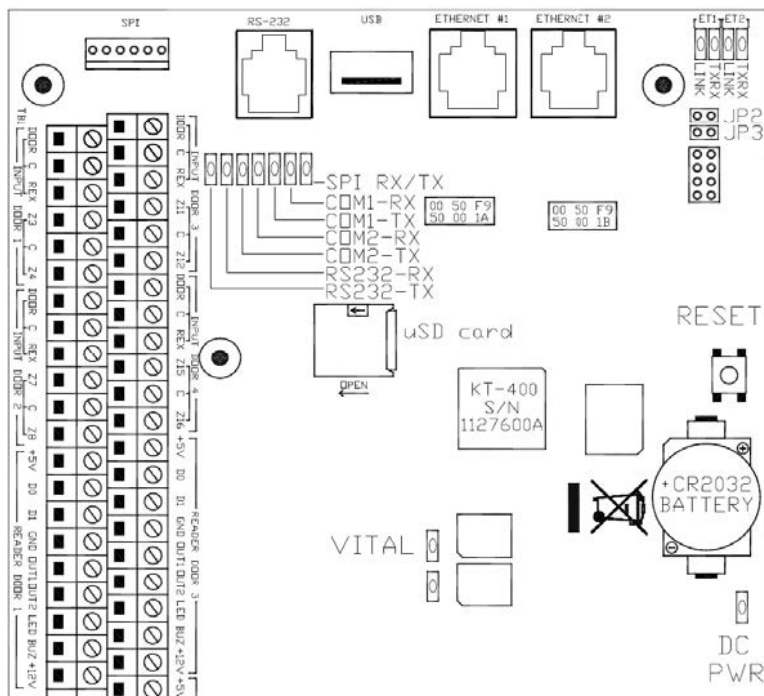

## KT-400 Ethernet Four-Door Controller Maintenance Recommendations

**Important:** Only a service person shall perform the following maintenance recommendations.

The KT-400 includes a lithium CR2032 primary battery (see the KT-400 Ethernet Four-Door Controller PCB View on page 6). This battery must be replaced by a **service person ONLY** to avoid any risk of explosion. If the lithium battery stops working, please contact the service person for maintenance if the lithium battery voltage measures below 2.75 VDC. Do not crush, puncture, open, disassemble or otherwise mechanically interfere with the battery. Do not try to recharge the battery. If you need to dispose of the PCB and/or the lithium battery, wrap the KT-400 in non-conductive tape. Check with your local authorities for battery disposal regulations.

**Warning:** Do not store the batteries in such a way that they come into contact with each other or with any piece of metal. Explosion or fire may occur. Should fire occur, use only dry chemical fire extinguishers. Do not use water to put out the fire. Do not heat the batteries. Do not dispose of the batteries or PCB in a fire. Do not disassemble the batteries. Do not apply pressure to or deform the batteries. Ensure that the above precautions are strictly observed by related departments, including, but not limited to, production, sales and outside contractors.

Regarding the recommended backup battery 12 VDC / 7 Ah: It is the service person's responsibility to assure that the disposal of used batteries is made according to the waste recovery and recycling regulations applicable to the intended market. Use the recommended battery type ONLY. It is strongly advised to have the following tests performed by **service persons ONLY**:

### 1. Biannual test for battery:

Remove AC power from the controller and let it work on battery backup power for 30 minutes. This test will ensure that in the event of a power failure, the battery will be able to support normal operations. This test should be performed twice a year. Once the test has been performed successfully, reconnect AC power to the controller.

### 2. Annual test for emergency lithium battery:

Measure voltage of lithium battery when power is totally removed from the controller (AC, DC and backup battery power). To ensure maximum operation and to prevent loss of the database, contact your KT-400 distributor to return the controller for maintenance if the lithium battery voltage measures below 2.75 VDC.



## Configuring the KT-400 using a browser

The KT-400 online interface provides a quick and easy setup and configuration option for users.

1. Determine your connection to the KT-400 and choose the appropriate network cable that you need.
2. To access the KT-400 web page open a browser on your computer or mobile device.
3. Enter KT followed by the last 6 digits of the MAC address into your browser in the following format: KT-XX-YY-ZZ.

## Activating the KT-400

You can activate the KT-400 in two ways depending on your requirements, auto and manual. You can use the KT-400 in two different modes, Standalone mode, or with full capability software, EntraPass, in order to connect to a system with additional doors and controllers. Standalone mode does not require the installation of software and is beneficial for users needing a quick setup solution. You can configure your controller in Standalone mode using any of the common web browsers.

The screenshot shows the 'Information' section of the KT-400 web interface. At the top right, there are language selection buttons for 'English', 'Français', and 'Español'. Below this, the 'Information' section displays the following details:

- Hardware: KT-400 Rev01
- Firmware: V2.00.07
- MAC address: 00-50-F9-55-29-DC
- Serial: 15061155

Below the information, a note states: 'This device can be used in either standalone mode or with full software capability (Kantech EntraPass)'. At the bottom, there are two buttons: 'Standalone' and 'EntraPass', separated by the text 'OR'.

## Activating Standalone mode

To activate your KT-400 in Standalone mode, click the **Standalone** button.

- In the **Activate now** tab enter the **Customer information** and **Installer information** and click the **Activate now** button.

The screenshot shows the 'Activate your KT-400' web interface. At the top, there are language selection buttons for 'English', 'Français', and 'Español'. Below this, the main heading is 'Activate your KT-400'. There are three buttons: 'Activate now', 'Other ways to activate', and 'Restore backup'. The 'Activate now' button is highlighted.

The form is divided into two columns: 'Customer information' and 'Installer information'. Each column contains the following fields:

- Site name
- Contact name
- Email
- Address line 1
- Address line 2
- City
- State/Province
- Country (dropdown menu, currently set to 'United States')
- ZIP/Postal code

At the bottom of the form, there is an 'Activate now' button.

**Note:** The product is not UL listed when used in Standalone mode.

## Other ways to activate Standalone mode

Alternatively you can select the **Other ways to activate** button.

1. Contact Kantech Technical Support in your region to get an **Activation code** or register the device on the Kantech website [www.kantech.com](http://www.kantech.com).
2. Enter the **Activation code**.

KT<sup>400</sup> English Français Español

### Activate your KT-400

Activate now Other ways to activate Restore backup

Controller type KT-400

Serial number 15061155

Activation code AAAAA-AAAA-AAAA-AAAA

Activate now

## Using EntraPass mode

To use in **EntraPass** mode click the **EntraPass** button.

1. Navigate to the **EntraPass gateway** pane.
2. Enter the **IP address** or **Domain name**.
3. Select a **Protocol**, TCP or UDP.
4. Enter a **Port**, UDP only.
5. Click the **Save** button.

## Configuring the KT-400 Ethernet Four-Door Controller with the KT-Finder

The KT-Finder is an application used to configure the KT-400 over the local area network (LAN) or the wide area network (WAN). It doesn't require any installation.

**Note:** To make it works on WAN, port forwarding is required.

**Important: The KT-Finder application is:**

- located in C:\Program Files\Kantech\Server\_xE\Bin,
- on the **EntraPass DVD-ROM**,
- available as a free download from <http://www.kantech.com>

1. Quit all EntraPass applications.
2. Make sure the KT-400 is in **Factory Default DHCP** mode. See **Table 3 on page 29**.
3. Start the KT-Finder.

**Note:** If you try to run the KT-Finder while running EntraPass, you will get an error message similar to this.



4. Select **KT-400** from the **Device** menu.
5. Enter the **MAC address** of the KT-400 then click on **Connect**.



- When the KT-400 is found, the configuration page displays.

KT-Finder Wizard

Language About

**KANTECH** **KT-Finder**  
Version 5.01.09

**KT-400**

Boot loader and firmware version 0.27 1.10.01

MAC address 00-50-F9-50-08-0A

**EntraPass Gateway**

EntraPass IP Address 10.38.192.99

Domain name

Domain name resolution . . . Test DNS

**Ethernet configuration**

Obtain an IP address automatically

Use the following IP address

IP address 10.38.192.158

Subnet Mask 255.255.252.0

Gateway (Router) 10.38.195.254

DNS server address 10.50.58.5

Protocol UDP

Port 18810

OK Cancel

- Put jumpers on **JP2** and **JP3**.
- Verify your *Network Configuration Information Sheet*:
  - Enter the **EntraPass IP address** or the **Domain name** of the **EntraPass Gateway**. This information must be the same as entered in EntraPass workstation for **Devices > Site**.
  - Select **Obtain an IP address automatically** or **Use the following IP address**. This information must be the same as entered in EntraPass workstation for **Devices > Site**.
- Select a **Protocol (UDP or TCP)**.
- Change the **Port** number, if required (not applicable in TCP).

**Note:** The port number should only be changed when you have more than one KT-400 at the same remote site.

- Click **OK**.
- Repeat the procedure for each Ethernet connected controllers at this site.

# KT-400 Ethernet Four-Door Controller

## Network Configuration Information Sheet

Company Name:

Site Name:

LAN or  WAN (see other side)

*Configuration in a local area network (LAN)*

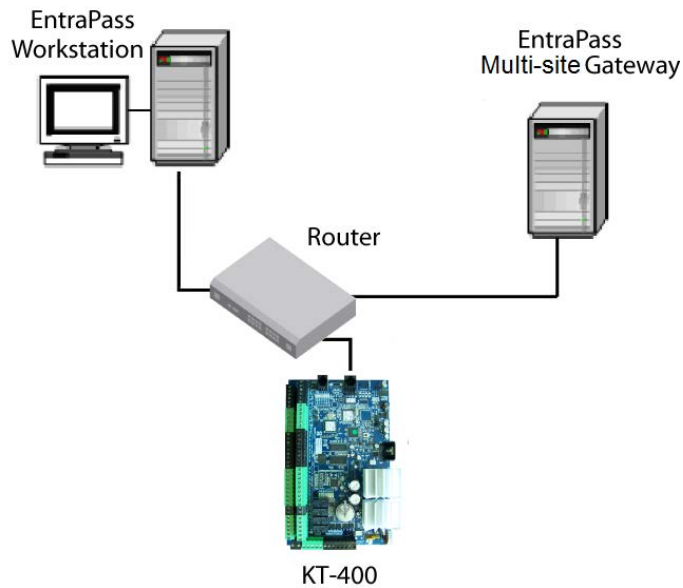

*For more details, please refer to the EntraPass Reference Manual.*

MAC Address: 00:50:F9: \_\_\_\_\_ : \_\_\_\_\_ : \_\_\_\_\_

Protocol: \_\_\_\_\_

Port (18810 by Default) or \_\_\_\_\_ (UDP only)

### IP Address Type:

DHCP

**or**

Static

IP Address: \_\_\_\_\_ . \_\_\_\_\_ . \_\_\_\_\_ . \_\_\_\_\_

Subnet Mask: \_\_\_\_\_ . \_\_\_\_\_ . \_\_\_\_\_ . \_\_\_\_\_

Default Gateway (Router): \_\_\_\_\_ . \_\_\_\_\_ . \_\_\_\_\_ . \_\_\_\_\_

### EntraPass Special Edition / Multi-site Gateway

IP Address: \_\_\_\_\_ . \_\_\_\_\_ . \_\_\_\_\_ . \_\_\_\_\_

## Configuration in a Wide Area Network (WAN)

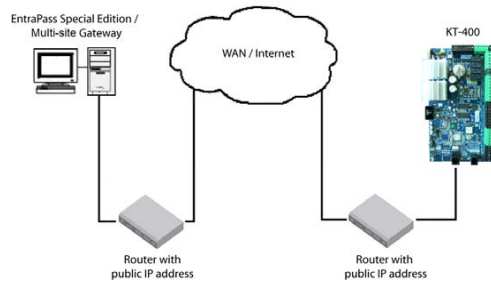

**Note:** Ethernet connections are not to be used for off-premise communication in UL installations.

### EntraPass Site

For more details, please refer to the *EntraPass Reference Manual*.

EntraPass Special Edition / Multi-site Gateway

IP Address: \_\_\_\_\_

#### Router

Public IP Address: \_\_\_\_\_

or

Domain name: \_\_\_\_\_

#### Port Forwarding Checklist

For more details, please refer to the *EntraPass Reference Manual*.

EntraPass Gateway Ports:  18001 (UDP) and  18801 (UDP) or 18802 (TCP)

### KT-400 Ethernet Four-Door Controller Site

MAC Address: 00:50:F9: \_\_\_\_\_

IP Address Type:  Static or  Reserved DHCP

IP Address: \_\_\_\_\_

Subnet Mask: \_\_\_\_\_

Default Gateway (Router): \_\_\_\_\_

DNS Server IP Address: \_\_\_\_\_

#### Router

Public IP Address: \_\_\_\_\_

or

Domain name: \_\_\_\_\_

#### Port Forwarding Checklist

**Note:** If you are using more than one KT-400 at the same remote site, you must use a unique port number for each KT-400.

KT-400 Ports:  18803 (UDP) and  18810 (UDP) or \_\_\_\_\_

**Note:** No port forwarded to the KT-400 if used in TCP.

## Installation checklist

To the Installer: If you are familiar with the installation, you can use the checklist with the symbol.

### Installing the KT-400 Ethernet Four-Door Controller

#### Preparing to install the KT-400 Ethernet Four-Door Controller

- Required to install KT-400 Ethernet Four-Door Controller

#### Physical Installation

- Check for ideal indoor location
- Stay away from electrical or communication devices

#### Earth Grounding

- AWG#18 grounding wire to EGND

#### Door Locking Devices

- Connect the door locked device to + and LK1-, (+ and LK2-), (+ and LK3-), or (+ and LK4-)
  - When jumper JP4 is on INT (internal), the maximum current draw is 1 Amp at 11.2 to 13.75 VDC, or
  - When jumper JP4 is on EXT (external), the maximum current draw is 1.0, 2.0, 3.0 or 4.0 Amps at 12 to 28
- VDC depending on power source used.
- Check for local "magnetic lock" regulations

#### Hooking Up Inputs

- Connect devices to inputs 1 to 16
- Resistors for all inputs 5.6K ohm (if necessary)
- Connect readers and keypads

#### Auxiliary Outputs

- Connect auxiliary outputs to readers and local warning devices

#### Tamper Protection

- Install tamper switch on cabinet

### Connecting the KT-400 Ethernet Four-Door Controller

#### Connecting the VC-485 or the USB-485 to the RS-485 Bus

- Connect the RS-485 cable to (COM1) +485- and the RS-485 signal ground to the 12 VDC AUX - (negative)

#### Connecting the Master Controller to the Host PC

- Connect the RS-232 flat cable from the KT-400 to the PC

## Connecting Expansion Modules to the KT-400 SPI Expansion Port

- Make sure input and output expansion modules are not in the same SPI group
- Calculate maximum current draw and connect external power supply(ies) to expansion module(s), if required
- Make sure the power jumper on the modules is in the correct position when using external power supply(ies)

## Powering the KT-400 Ethernet Four-Door Controller

- Install the transformer or DC power supply, if applicable
- Place battery in cabinet
- Connect the battery
- Power up the KT-400 Ethernet Four-Door Controller



## Inputs and outputs assignments sheet

<b>DOORS</b>		
DOOR 1	CONTACT	REX
DOOR 2	CONTACT	REX
DOOR 3	CONTACT	REX
DOOR 4	CONTACT	REX
<b>INPUTS</b>		
DOOR Z1	NO or NC	EOL, DRY or DEOL
REX Z2	NO or NC	EOL, DRY or DEOL
INPUT Z3	NO or NC	EOL, DRY or DEOL
INPUT Z4	NO or NC	EOL, DRY or DEOL
DOOR Z5	NO or NC	EOL, DRY or DEOL
REX Z6	NO or NC	EOL, DRY or DEOL
INPUT Z7	NO or NC	EOL, DRY or DEOL
INPUT Z8	NO or NC	EOL, DRY or DEOL
DOOR Z9	NO or NC	EOL, DRY or DEOL
REX Z10	NO or NC	EOL, DRY or DEOL
INPUT Z11	NO or NC	EOL, DRY or DEOL
INPUT Z12	NO or NC	EOL, DRY or DEOL
DOOR Z13	NO or NC	EOL, DRY or DEOL
REX Z14	NO or NC	EOL, DRY or DEOL
INPUT Z15	NO or NC	EOL, DRY or DEOL
INPUT Z16	NO or NC	EOL, DRY or DEOL
<b>RELAY OUTPUTS</b>		
RELAY 1	NO	NC
RELAY 2	NO	NC
RELAY 3	NO	NC
RELAY 4	NO	NC

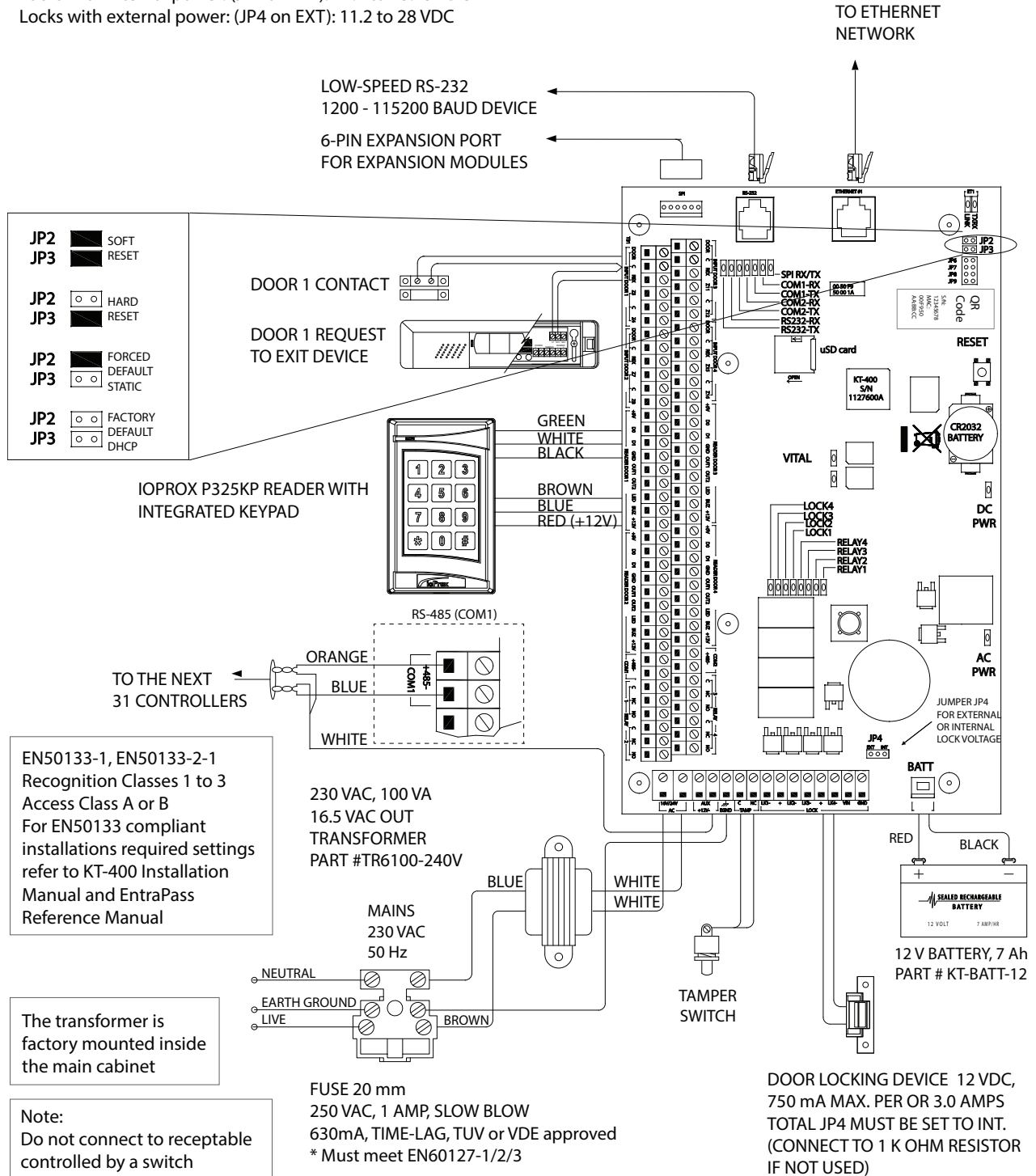

Figure 15: KT-400-EU Inner Door Sticker Diagram (European Union)

**Note regarding output voltage ratings:**

- Auxiliary Power: 11.2 to 13.75 VDC
- 12 VDC Readers: 11.2 to 13.75 VDC
- 5 VDC Readers: 5 VDC
- Locks with internal power: (JP4 on INT): 11.2 to 13.75 VDC
- Locks with external power: (JP4 on EXT): 11.2 to 28 VDC

If required, the KT-400 can provide galvanically isolated output(s) by programming any of the relays.



## Appendix A

### Compliance specifications

#### UL

To comply with UL listings, the following requirements must be met:

- Use of a UL listed computer
- Use of UL listed readers (Wiegand 26 and 34 bits, mag stripe 26 and 34 bits, XSF 39 bits have been tested and found to comply)
- Use of a UL recognized tamper switch on every housing cabinet for the KT-400 Ethernet Four-Door Controller
- Do not use the SmartLink option
- Do not use a 230 VAC transformer (not UL listed)
- Use only UL listed cables
- Use only UL listed adaptors
- Use only a UL listed transformer Hammond BF2F or BF2G such as Kantech part number TR1675 or TR 2475 (available through Kantech distributors or dealers, please refer to the Technical Support contact information on page 2 to obtain the specific transformer)
- The KT-400-EU has not been validated as a UL Listed system.
- The KT-CAB3000LDR and KT-CAB4000LDR have been evaluated by UL as alternate enclosures.

**Note:** All circuits are power limited.

#### UL 294 compliance notice

- IP Connectivity: Only for supplementary use when planning to install the KT-400 Ethernet Four-Door Controller with a UL 294 access control system.
- Use only UL 294 or UL 1076 listed power supply
- Connect Kantech part number KT-ACPW-LED status indicator to the AC terminals of the KT-400 (or connect it to relay 1 with the appropriate configuration when using KT-PS-120)
- Use Kantech part number KT-BATT-12 battery, see **Note**.

**Note:** Using a 12V/7Ah battery, backup battery provides a minimum of 4 hours as per Section 33 of UL 294, fifth edition.

#### UL 1076 compliance notice

- The KT-400 is UL 1076 Listed as a Commercial Proprietary Control Unit Accessory and Proprietary Burglar Alarm Unit (Section 83.2), with EntraPass and Redundant Server, alarm system features, KT-300 Controllers, ioProx Proximity readers, and TRex request to exit devices – other sensor devices (temperature, water level, etc.) may be used as long as they are also UL 1076 Listed.
- The EntraPass and Redundant Server shall be running at all time, and manned 24 hours a day, 365 days a year – The EntraPass and Redundant Server will each have their own operator workstation.
- Data processing equipment and office appliance and business equipment used as central supervisory equipment station shall be listed to Information Technology Equipment - UL 60950-1.
- Should the EntraPass and/or Redundant Server be replaced, a UL 60950-1 listed computer must be used.
- The following recommended system requirements apply to the EntraPass Server, Redundant Server, Video Vault, Card Gateway, SmartLink, and Workstation:
  - Operating Systems: Windows® 2000/XP/2003/2008/Windows 7 Standard and Enterprise Server Editions/Vista
  - Processor: Dual Core
  - 2 GB RAM

- Minimum free hard disk space: 20 GB
- Color depth: 24-bit (16 million colors), required for Video Integration only
- Screen resolution: 1024 x 768
- AGP or PCI Express 8X graphics card with 64 MB memory and DirectX 9.0 support.
- Network Interface card: 10/100 Base-T network adaptor

**Note:** Actual requirements may vary based on your operating system and configuration.

- The Central Supervisory Equipment shall employ supply line transient protection complying with the Standard for Transient Voltage Surge Suppressors, UL 1449, with a maximum marked rating of 330 V.
- The Central Supervisory Equipment shall employ signal line Transient protection complying with the Standard for Protectors for Data Communications and Fire Alarm Circuits, UL 497B, with a maximum marked rating of 50 V.
- The Central Supervisory Equipment shall employ that communication circuits and network components connected to the telecommunications network shall be protected by secondary protectors for communication circuits. These protectors shall comply with the Standard for Secondary Protectors for Communications Circuits, UL 497A. These protectors shall be used only in the protected site of the telecommunications network.
- The Central Supervisory Equipment shall be installed in a temperature controlled environment. A temperature controlled environment is defined as one that can be maintained between 13° - 35°C (55° - 95°F) by HVAC system. Twenty-four hours on standby power shall be provided for the HVAC system. The standby power system for the HVAC system may be supplied by an engine driven generator alone. A standby battery is not required to be used.
- A marking to identify the application and signaling function of the product is located on the inside of the unit (inner door sticker).
- For certified commercial proprietary control unit accessory applications, the requirements of UL 1076, Commercial Proprietary Control Unit Accessory also apply.
- Use Kantech part number KT-3LED-PLATE 3-color LED indicators mounted on single plate when the KT-400 is configured with the (APOU/ALVY) KT-NCC in an EntraPass Global Edition system for remote alarm monitoring. Refer to the KT-NCC Installation Manual, DN1611 for additional details.
- The reader(s), that is(are) designated to arm or disarm the alarm system, must be within the secured side of the customer premises.
- The following Kantech readers have been validated by UL for the UL 1076 Standard: P225W26, P225KPW26, P225XSF, P225KPXSF, P325W26, P325KPW26, P325XSF, P325KPXSF and P600.

**Note:** All readers can be ordered with or without the following suffixes: BEI, BEI-SE, GRY or GRY-SE.

- The KT-400 Ethernet Four-Door Controller is UL 1076 listed when used with the (APOU/ALVY) KT-NCC (Network Communications Controller).
- All alarms shall be reported and acknowledged in the following priority:

**Note:** To set these priorities, please adjust the Event Parameters, found in EntraPass System

- Fire alarm and industrial supervision where a risk of injury to persons, or damage or destruction of property may be involved
- Hold-up or panic alarm
- Burglar alarm
- Watchman tour (Guard tour)
- Fire-alarm supervision
- Burglar-alarm supervision
- Industrial supervision where a risk of injury to persons, or damage or destruction of property will not be involved.

If multiplex system signals are transmitted directly from the protected systems to the central supervising station and the loss of the channel prevents the receipt of signals from protective circuits beyond the fault, the number of separate signals on a single channel shall be limited to 1000.

Ethernet connections on the KT-400 are not to be used for off-premise communication in UL1076 installations. For remote alarm monitoring use KT-400 in conjunction with KT-NCC.

## FCC & ICC

Operation is subject to the following two conditions: (1) this device may not cause harmful interference, and (2) this device must accept any interference received including interference that may cause undesired operation.

This class A digital apparatus meets all requirements of the Canadian Interference Causing Equipment Regulations.

## CE & C-Tick

- EN50133-1: Alarm systems - Access control systems for use in security applications: system requirements.
- EN55022: Information technology equipment, radio disturbance characteristics.
- EN60950-1: Information technology equipment, safety.
- EN61000-6-1: Electromagnetic Compatibility (EMC) - Generic Standards - Immunity for residential, commercial and light-industrial environments.
- EN61000-6-2: Electromagnetic Compatibility (EMC) - Generic Standards - Immunity for industrial environments.

The KT-400 Ethernet Four-Door Controller is also compliant with EN55022:2006 +A1:2007, Class B.

## EN50133 compliance notes and requirements

The KT-400 Ethernet Four-Door Controller provides the following functions as per EN50133-1 Fig 1 and Section 4.1:

- processing (1)
- power supply (2)
- self protection (3)
- programmability (4) when using the EntraPass Version 4.01 and higher
- access point control (5)
- recognition (6) when used in conjunction with the compatible recognition modules (access point interfaces)
- annunciation (8) when used in conjunction with the EntraPass Ver 4.01 and higher
- communication with other systems (9) only when used in conjunction with the EntraPass Ver 4.01 and higher

The KT-400 Ethernet Four-Door Controller can be used in conjunction with user interfaces that support recognition classes 0, 1, 2, and 3 and it supports access class A or B depending on the desired installation of the access control system.

- Environmental Class 2, Equipment Class Fixed
- IP Class 30
- IK Rating 04

The KT-400 Ethernet Four-Door Controller is capable to meet the EN50131-1 requirements after programming the right parameters as follows:

- For a system using memorised information the applicable parameters (“Invalid attempts before keypad disabled” and “Keypad disabled duration”) shall be set to 5 sequential entries of incorrect information along with an access blocking period of minimum 5 minutes afterwards (applicable to recognition class 1).
- For a system using a combination of tokens or biometric and memorized information, the applicable parameters (“Invalid attempts before keypad disabled”) shall be set to maximum 5 sequential entries of incorrect information before an alert is generated at the monitoring console (applicable to recognition class 3).
- The applicable parameter (“Relock on access”) shall be set so that the access interface control output is reset when the preset release time has expired or when the APAS is opened.
- The applicable parameter (“Input response time”) for maximum delay time between the occurrence of an event and the annunciation of this event shall be set so that the alert is received at the monitoring console in less than 10 seconds for the worst case configuration of the access control system. Please refer to the appropriate section in the EntraPass reference manual.
- Alerts annunciation at the monitoring console (EntraPass) shall be programmed to occur when a tamper condition is generated, an access point is opened without granted access or if the access point remains open longer than the allowed period of time.

- The KT-400 Ethernet Four-Door Controller shall be used in conjunction with EntraPass in order to be able to annunciate these events for all recognition classes. All these events are displayed immediately in the Global Edition of EntraPass software (within less than 10 seconds from the time the event is received).
- When the KT-400 Ethernet Four-Door Controller is using a combination of tokens or biometric and memorized information (recognition class 3), it shall be programmed so that it will give an alert after a maximum of 5 sequential entries of invalid memorized information with the same token or biometric. The alert shall be received at the monitoring console in less than 10 seconds.
- Recognition class 2 and 3 shall use only access point readers for which the false acceptance rate is less than 0.01% and the false rejection rate is less than 1%.
- The memorized information (PIN) used in conjunction with the token or biometric (recognition class 2 and 3) shall have a minimum number of differs of 10 000. The KT-400 Ethernet Four-Door Controller is using 5 or 6 digit codes as PIN numbers. Please refer to page 232 of the EntraPass Reference Manual. For recognition class 3, only 6 digits PIN numbers shall be used.
- Tokens with coding systems visible to the unaided human eye and therefore usually easy to duplicate under condition of normal use shall not be used. When the token is marked with an identity number, it shall not be a direct representation of the entire coding borne by the token.
- KT-MPD-INP16 and KT-MOD-OUT16 modules, when used in conjunction with KT-400 Access Control Unit, shall be installed in the same enclosure with the KT-400 Ethernet Four-Door Controller or in separate additional KT enclosure. When installed in separate KT enclosures, these enclosures shall be provided each with a tamper detection switch.
- Connect tamper wiring to one available input on the KT-MOD-INP16 module and program the corresponding input using the EntraPass software: "Devices/Input" as a label "Tamper" input that is programmed in "Event parameters" to act as an alert when activated. Please refer to page 110 of the EntraPass Reference Manual for programming instructions.
- The output on the KT-400 Ethernet Four-Door Controller that is intended to be used with a door lock shall be used in conjunction with a separately energized relay in order to provide 30VA galvanic isolation. The output shall be programmed using the EntraPass software to activate when an authorized access has been granted to the respective access point.
- All access granted events shall be annunciated at the monitoring console using the EntraPass software ("Access granted") in conjunction with the access granted annunciation at the monitoring console, the following conditions shall also be programmed to be annunciated by the EntraPass software:
  - the access point is opened and closed; ("Door closed/normal condition")
  - permitted APAS release time has expired without the access point being opened; ("Time out on access granted")
  - the access point has remained open and the allowed APAS open time period has expired ("Door open too long").

**KANTECH**

*From Tyco Security Products*

© 2018 Tyco Security Products. All rights reserved.

[www.kantech.com](http://www.kantech.com)

