

Soundweb™ London

BLU-800/BLU-805/BLU-806/BLU-806DA/BLU-320/ BLU-325/BLU-326/BLU-326DA/BLU-160/BLU-120 Installation Guide

5086087-A

IMPORTANT SAFETY INSTRUCTIONS



WARNING: TO REDUCE THE RISK OF FIRE OR ELECTRIC SHOCK DO NOT EXPOSE THIS EQUIPMENT TO RAIN OR MOISTURE

ATTENTION: POUR RÉDUIRE LE RISQUE D'INCENDIE OU D'ÉLECTROCUTION N'EXPOSEZ PAS CET APPAREIL À LA PLUIE OU L'HUMIDITÉ

The symbols shown above are internationally accepted symbols that warn of potential hazards with electrical products. The lightning flash with arrowpoint in an equilateral triangle means that there are dangerous voltages present within the unit. The exclamation point in an equilateral triangle indicates that it is necessary for the user to refer to the owner's manual.

These symbols warn that there are no user serviceable parts inside the unit. Do not open the unit. Do not attempt to service the unit yourself. Refer all servicing to qualified personnel. Opening the chassis for any reason will void the manufacturer's warranty. Do not get the unit wet. If liquid is spilled on the unit, shut it off immediately and take it to a dealer for service. Disconnect the unit during storms to prevent damage.

The following is indicative of low altitude use; do not use this product above 2000m.



U.K. MAINS PLUG WARNING

A molded mains plug that has been cut off from the cord is unsafe. Discard the mains plug at a suitable disposal facility.

NEVER UNDER ANY CIRCUMSTANCES SHOULD YOU INSERT A DAMAGED OR CUT MAINS PLUG INTO A 13 AMP POWER SOCKET.

Do not use the mains plug without the fuse cover in place. Replacement fuse covers can be obtained from your local retailer. Replacement fuses are 13 amps and **MUST** be ASTA approved to BS1362.



If you want to dispose this product, do not mix it with general household waste. There is a separate collection system for used electronic products in accordance with legislation that requires proper treatment, recovery and recycling.

Private households in the 25 member states of the EU, in Switzerland and Norway may return their used electronic products free of charge to designated collection facilities or to a retailer (if you purchase a similar new one).

For Countries not mentioned above, please contact your local authorities for a correct method of disposal.

By doing so you will ensure that your disposed product undergoes the necessary treatment, recovery and recycling and thus prevent potential negative effects on the environment and human health.

WARNING FOR YOUR PROTECTION READ THE FOLLOWING:

READ THESE INSTRUCTIONS.

KEEP THESE INSTRUCTIONS.

HEED ALL WARNINGS.

FOLLOW ALL INSTRUCTIONS.

DO NOT USE THIS APPARATUS NEAR WATER.

CLEAN ONLY WITH A DRY CLOTH.

FOR INDOOR USE ONLY.

DO NOT BLOCK ANY OF THE VENTILATION OPENINGS. INSTALL IN ACCORDANCE WITH THE MANUFACTURER'S INSTRUCTIONS.

DO NOT INSTALL NEAR ANY HEAT SOURCES SUCH AS RADIATORS, HEAT REGISTERS, STOVES, OR OTHER APPARATUS (INCLUDING AMPLIFIERS) THAT PRODUCE HEAT.

ONLY USE ATTACHMENTS/ACCESSORIES SPECIFIED BY THE MANUFACTURER.

UNPLUG THIS APPARATUS DURING LIGHTNING STORMS OR WHEN UNUSED FOR LONG PERIODS OF TIME.

Do not defeat the safety purpose of the polarized or grounding-type plug. A polarized plug has two blades with one wider than the other. A grounding type plug has two blades and a third grounding prong. The wide blade or third prong are provided for your safety. If the provided plug does not fit your outlet, consult an electrician for replacement of the obsolete outlet.

Protect the power cord from being walked on or pinched particularly at plugs, convenience receptacles, and the point where they exit from the apparatus.

Use only with the cart stand, tripod bracket, or table specified by the manufacture, or sold with the apparatus. When a cart is used, use caution when moving the cart/apparatus combination to avoid injury from tip-over.



Refer all servicing to qualified service personnel. Servicing is required when the apparatus has been damaged in any way, such as power-supply cord or plug is damaged, liquid has been spilled or objects have fallen into the apparatus, the apparatus has been exposed to rain or moisture, does not operate normally, or has been dropped.

POWER ON/OFF SWITCH: The Power switch used in this piece of equipment **DOES NOT** break the connection from the mains.

MAINS DISCONNECT: The plug shall remain readily operable. For rack-mount or installation where plug is not accessible, an all-pole mains switch with a contact separation of at least 3 mm in each pole shall be incorporated into the electrical installation of the rack or building.

If connected to 240V supply, a suitable CSA/UL certified power cord shall be used for this supply.

This Equipment is intended for rack mount use only.

IMPORTANT SAFETY INSTRUCTIONS

ELECTROMAGNETIC COMPATIBILITY

This device complies with part 15 of the FCC Rules and the Product Specifications noted on the **Declaration of Conformity**. Operation is subject to the following two conditions:

- this device may not cause harmful interference, and
- this device must accept any interference received, including interference that may cause undesired operation.

Operation of this unit within significant electromagnetic fields should be avoided.

- use only shielded interconnecting cables.

SAFETY INSTRUCTIONS

NOTICE FOR CUSTOMERS IF YOUR UNIT IS EQUIPPED WITH A POWER CORD.

WARNING: THIS APPLIANCE SHALL BE CONNECTED TO A MAINS SOCKET OUTLET WITH A PROTECTIVE EARTHING CONNECTION.

THE CORES IN THE MAINS LEAD ARE COLOURED IN ACCORDANCE WITH THE FOLLOWING CODE:

GREEN AND YELLOW - EARTH BLUE - NEUTRAL BROWN - LIVE

AS COLOURS OF THE CORES IN THE MAINS LEAD OF THIS APPLIANCE MAY NOT CORRESPOND WITH THE COLOURED MARKINGS IDENTIFYING THE TERMINALS IN YOUR PLUG, PROCEED AS FOLLOWS:

- THE CORE WHICH IS COLOURED GREEN AND YELLOW MUST BE CONNECTED TO THE TERMINAL IN THE PLUG MARKED WITH THE LETTER E, OR WITH THE EARTH SYMBOL, OR COLOURED GREEN, OR GREEN AND YELLOW.
- THE CORE WHICH IS COLOURED BLUE MUST BE CONNECTED TO THE TERMINAL MARKED N OR COLOURED BLACK.
- THE CORE WHICH IS COLOURED BROWN MUST BE CONNECTED TO THE TERMINAL MARKED L OR COLOURED RED.

THIS EQUIPMENT MAY REQUIRE THE USE OF A DIFFERENT LINE CORD, ATTACHMENT PLUG, OR BOTH, DEPENDING ON THE AVAILABLE POWER SOURCE AT INSTALLATION. IF THE ATTACHMENT PLUG NEEDS TO BE CHANGED, REFER SERVICING TO QUALIFIED SERVICE PERSONNEL WHO SHOULD REFER TO THE TABLE BELOW. THE GREEN/YELLOW WIRE SHALL BE CONNECTED DIRECTLY TO THE UNITS CHASSIS.

CONDUCTOR		WIRE COLOR	
		Normal	Alt
L	LIVE	BROWN	BLACK
N	NEUTRAL	BLUE	WHITE
E	EARTH GND	GREEN/YEL	GREEN

WARNING: IF THE GROUND IS DEFEATED, CERTAIN FAULT CONDITIONS IN THE UNIT OR IN THE SYSTEM TO WHICH IT IS CONNECTED CAN RESULT IN FULL LINE VOLTAGE BETWEEN CHASSIS AND EARTH GROUND. SEVERE INJURY OR DEATH CAN THEN RESULT IF THE CHASSIS AND EARTH GROUND ARE TOUCHED SIMULTANEOUSLY.

WARNING:

- APPARATET MÅ TILKOPLES JORDET STIKKONTAKT.
- APPARATEN SKALL ANSLUTAS TILL JORDAT UTTAG.
- LAITE ON LIITETTÄVÄ SUOJAKOSKETTIMILLA VARUSTETTUUN PISTORASIAAN.
- APPARATET SKAL TILSLUTTES JORDET STIKKONTAKT.

DECLARATION OF CONFORMITY

Manufacturer's Name: BSS Audio
Manufacturer's Address: 10653 S. River Front Parkway, Suite 300 South Jordan, Utah 84095, USA

With regard to Directive 2005/32/EC and EC Regulation 1275/2008 of 17 December 2008, this product is designed, produced, and classified as Professional Audio Equipment and thus is exempt from this Directive.

declares that the product:

Product name: BLU 120, BLU 160, BLU 320, BLU 325, BLU 326, BLU 800, BLU 805 and BLU 806

Note: Product name may be suffixed by a combination of the letters EU, M, or V.

C. Rex Reed
Director, Engineering
Signal Processing
10653 S. River Front Parkway, Suite 300 South Jordan, Utah 84095, USA
Date: August 15, 2016

European Contact:

Product option: Various I/O Cards

conforms to the following Product Specifications:

Safety: IEC 60065 -01+Amd 1 & 2

EMC: EN 55022:2010
EN 55024:2010
FCC Part 15

Supplementary Information:

The product herewith complies with the requirements of the:
Low Voltage Directive 2014/35/EU
EMC Directive 2014/30/EU
RoHS Directive 2011/65/EU
WEEE Directive 2012/19/EU

Harman International
Salisbury House
London Wall
EC2M 5QQ
+44 207 562 9450

or

Harman Professional Inc.
10653 S. River Front Parkway, Suite 300 South Jordan, Utah 84095, USA
Ph: (801) 566-8800
Fax: (801) 568-7583

DECLARATION OF CONFORMITY

Manufacturer's Name: BSS Audio
Manufacturer's Address: 10653 S. River Front Parkway, Suite 300 South Jordan, Utah 84095, USA

With regard to Directive 2005/32/EC and EC Regulation 1275/2008 of 17 December 2008, this product is designed, produced, and classified as Professional Audio Equipment and thus is exempt from this Directive.

declares that the product:

Product name: BLU 326 (DA) and 806 (DA)

Note: Product name may be suffixed by a combination of the letters EU, M, or V.

C. Rex Reed
Director, Engineering
Signal Processing
10653 S. River Front Parkway, Suite 300 South Jordan, Utah 84095, USA
Date: March 14, 2017

European Contact:

Product option: Various I/O Cards

conforms to the following Product Specifications:

Safety: IEC 60065: 8th Ed. 2014

EMC: EN 55032: 2012
EN 55024: 2010
FCC Part 15

Supplementary Information:

The product herewith complies with the requirements of the:
Low Voltage Directive 2014/35/EU
EMC Directive 2014/30/EU
RoHS Directive 2011/65/EU
WEEE Directive 2012/19/EU

Harman International
Salisbury House
London Wall
EC2M 5QQ
+44 207 562 9450

or

Harman Professional Inc.
10653 S. River Front Parkway, Suite 300 South Jordan, Utah 84095, USA
Ph: (801) 566-8800
Fax: (801) 568-7583

CONSIGNES DE SÉCURITÉ IMPORTANTES



WARNING: TO REDUCE THE RISK OF FIRE OR ELECTRIC SHOCK DO NOT EXPOSE THIS EQUIPMENT TO RAIN OR MOISTURE

ATTENTION: POUR RÉDUIRE LE RISQUE D'INCENDIE OU D'ÉLECTROCUTION N'EXPOSEZ PAS CET APPAREIL À LA PLUIE OU L'HUMIDITÉ

Les symboles illustrés ci-dessus sont des symboles acceptés internationalement qui avertissent des dangers potentiels relatifs à l'utilisation de produits électriques. Le voyant clignotant avec une flèche dans un triangle équilatéral signifie la présence de tensions dangereuses dans l'appareil. Le point d'exclamation dans un triangle équilatéral indique que l'utilisateur doit se référer au manuel d'utilisation.

Ces symboles indiquent qu'il n'y a aucune pièce utilisable par l'utilisateur à l'intérieur de l'appareil. Ne pas ouvrir l'appareil. Ne pas essayer de réparer soi-même l'appareil. Confier toute réparation à du personnel qualifié. Ouvrir la structure de l'appareil pour quelque raison que ce soit annulera la garantie du fabricant. Ne pas mouiller l'appareil. Si du liquide est renversé sur l'appareil, fermer immédiatement l'appareil et l'apporter chez un réparateur. Débrancher l'appareil pendant les tempêtes afin d'éviter des dommages.

Ce qui suit est représentatif d'une utilisation à basse altitude ; ne pas utiliser ce produit au-dessus de 2000 m.



AVERTISSEMENT CONCERNANT LA FICHE SECTEUR

Une fiche secteur moulée qui a été coupée du cordon est dangereuse. Jeter la fiche secteur dans un centre de déchets adapté.

VOUS NE DEVEZ EN AUCUNE CIRCONSTANCE INSÉRER UNE FICHE ENDOMMAGÉE OU COUPÉE DANS UNE PRISE SECTEUR 13 AMP.

Ne pas utiliser la fiche secteur si le couvercle du coffret à fusibles n'est pas bien en place. Vous pouvez vous procurer des capots de fusible de rechange auprès de votre détaillant local. Les fusibles de remplacement sont de 13 A et DOIVENT être approuvés ASTA, BS1362.



Ne pas jeter ce produit avec les ordures ménagères. Il existe un système de collecte sélective pour les produits électroniques usagés en conformité avec les lois en vigueur en matière de traitement, de récupération et de recyclage.

Dans les 25 États membres de l'UE, en Norvège et en Suisse, les ménages peuvent envoyer leurs produits électroniques usagés sans frais vers des centres de collecte sélective ou chez un distributeur (contre l'achat d'un nouveau produit).

Contactez les autorités locales pour connaître les procédures de traitement des déchets adaptées dans les pays non mentionnés ci-dessus.

Non seulement cette précaution vous permettra d'être sûr que votre produit est correctement traité, récupéré et recyclé, mais elle vous évitera également de nuire involontairement à l'environnement et à la santé humaine.

AVERTISSEMENT POUR VOTRE SÉCURITÉ LIRE ATTENTIVEMENT :

LIRE CES CONSIGNES.

CONSERVER CES CONSIGNES.

RESPECTER TOUS LES AVERTISSEMENTS.

SUIVRE TOUTES LES CONSIGNES.

NE PAS UTILISER CET APPAREIL PRÈS DE L'EAU.

NETTOYER UNIQUEMENT AVEC UN CHIFFON SEC.

POUR USAGE INTÉRIEUR UNIQUEMENT.

NE PAS OBSTRUER LES OUIËS D'AÉRATION. EFFECTUER L'INSTALLATION CONFORMÉMENT AUX INSTRUCTIONS DU FABRICANT.

NE PAS INSTALLER À PROXIMITÉ DE SOURCES DE CHALEUR TELLES QUE DES RADIATEURS, BOUCHES D'AÉRATION, PLAQUES CHAUFFANTES OU TOUT AUTRE APPAREIL (Y COMPRIS DES AMPLIFICATEURS) DÉGAGEANT DE LA CHALEUR.

UTILISER UNIQUEMENT LES PIÈCES/ACCESSOIRES MENTIONNÉS PAR LE FABRICANT.

DÉBRANCHER L'APPAREIL AU COURS DES ORAGES OU EN CAS DE NON-UTILISATION PENDANT UNE DURÉE PROLONGÉE.

Ne pas détériorer la sécurité de la fiche polarisée ou de la fiche de terre. Les fiches polarisées sont équipées de deux bornes de largeurs différentes. Les fiches de terre comportent deux lames et une troisième broche de mise à la terre. La broche la plus large ou troisième broche de mise à la terre est prévue pour votre sécurité. Si la fiche fournie ne correspond pas à votre installation électrique, faire appel à un électricien pour remplacer la prise hors normes.

Protéger le cordon d'alimentation contre les risques de piétinement ou de pincement, notamment au niveau des fiches, des prises de courant et du point d'attache avec le matériel.

Utiliser uniquement le chariot, le support, le trépied ou la table spécifié(e) par le fabricant ou vendu(e) avec le matériel. Si vous utilisez un chariot pour déplacer l'appareil, soyez suffisamment prudent pour éviter une éventuelle blessure consécutive au basculement du chariot et de sa charge.



Les réparations doivent être confiées à un technicien S.A.V. qualifié. Une réparation est nécessaire en cas de dommage quelconque et en particulier en cas d'endommagement du cordon d'alimentation ou de la fiche électrique, d'infiltration liquide, d'introduction involontaire d'un objet dans l'appareil, d'exposition de l'appareil à la pluie ou à un milieu humide, de fonctionnement anormal ou de chute de l'appareil.

INTERRUPTEUR MARCHÉ/ARRÊT : l'interrupteur d'alimentation de cet équipement NE coupe PAS la connexion secteur.

DÉBRANCHEMENT DE L'APPAREIL : la prise de courant doit rester facilement accessible. Pour un montage en rack ou une installation avec une prise inaccessible, un interrupteur omnipolaire à distance d'ouverture de contact d'au moins 3 mm doit être intégré à l'installation électrique du rack ou du local.

Si le matériel est relié à une alimentation de 240 V, utiliser impérativement un cordon d'alimentation adapté certifié CSA/UL pour ce branchement.

Cet équipement est exclusivement destiné à un montage en rack.

CONSIGNES DE SÉCURITÉ IMPORTANTES

COMPATIBILITÉ ÉLECTROMAGNÉTIQUE

Cet appareil est conforme au volet 15 des règles du FCC et aux spécifications techniques évoquées dans la **Déclaration de conformité**. Son fonctionnement est soumis aux deux conditions suivantes :

- cet appareil ne doit pas causer d'interférences nuisibles et
- cet appareil doit accepter les interférences captées, y compris les interférences susceptibles de nuire à son fonctionnement.

L'utilisation de cet appareil à proximité de champs électromagnétiques puissants n'est pas recommandée.

- utiliser exclusivement des câbles d'interconnexion blindés.

CONSIGNES DE SÉCURITÉ

NOTICE ADRESSÉE AUX CONSOMMATEURS ÉQUIPÉS D'UN MATÉRIEL AVEC CORDON D'ALIMENTATION FOURNI.

AVERTISSEMENT : CET APPAREIL DOIT ÊTRE BRANCHÉ SUR UNE PRISE SECTEUR DOTÉE D'UNE PROTECTION PAR MISE À LA TERRE.

LES COULEURS DES NOYAUX DANS LES FILS SECTEURS DOIVENT RESPECTER LES CODES SUIVANTS :

VERT ET JAUNE - TERRE BLEU - NEUTRE MARRON - PHASE

LES COULEURS DES NOYAUX DANS LES FILS SECTEURS DE CET APPAREIL PEUVENT NE PAS CORRESPONDE AUX INSCRIPTIONS COLORÉES IDENTIFIANT LES TERMINAUX DANS VOTRE FICHE ; IL FAUT DONC PROCÉDER DE LA FAÇON SUIVANTE :

- LE NOYAU VERT ET JAUNE DOIT ÊTRE BRANCHÉ AU TERMINAL DE LA FICHE OÙ APPARAÎT LA LETTRE E OU LE SYMBOLE DE MISE À LA TERRE, OU AU TERMINAL VERT OU VERT ET JAUNE.
- LE NOYAU BLEU DOIT ÊTRE BRANCHÉ AU TERMINAL MARQUÉ D'UN N OU DE COULEUR NOIRE.
- LE NOYAU MARRON DOIT ÊTRE BRANCHÉ AU TERMINAL MARQUÉ D'UN L OU DE COULEUR ROUGE.

CE MATÉRIEL PEUT NÉCESSITER L'UTILISATION D'UN CORDON D'ALIMENTATION DIFFÉRENT ET/OU D'UNE FICHE DE BRANCHEMENT DIFFÉRENTE SELON LA SOURCE D'ALIMENTATION DISPONIBLE À L'INSTALLATION. SI LA FICHE DE BRANCHEMENT DOIT ÊTRE CHANGÉE, FAIRE APPEL À UN TECHNICIEN QUALIFIÉ QUI DEVRA SE RÉFÉRER AU TABLEAU CI-DESSOUS. LE FIL VERT/JAUNE DOIT ÊTRE BRANCHÉ DIRECTEMENT AU CHÂSSIS DE L'APPAREIL.

CONNECTEURS		COULEUR DU FIL	
		Normal	Alt
L	PHASE	MARRON	NOIR
N	NEUTRE	BLEU	BLANC
E	TERRE	VERT/JAU	VERT

ATTENTION : UN DÉFAUT DE MISE À LA TERRE PEUT PROVOQUER CERTAINS DYSFONCTIONNEMENTS DE L'APPAREIL OU DU SYSTÈME AUQUEL IL EST RELIÉ, POUVANT SE TRADUIRE PAR UNE TENSION COMPOSÉE ENTRE LA MASSE ET LA PRISE DE TERRE. CELA PEUT PROVOQUER DES BLESSURES SÉRIEUSES OU FATALES SI LA MASSE ET LA PRISE DE TERRE SONT TOUCHÉES EN MÊME TEMPS.

ATTENTION :

- APPARATET MÅ TILKOPLES JORDET STIKKONTAKT.
- APPARATEN SKALL ANSLUTAS TILL JORDAT UTTAG.
- LAITE ON LIITETTÄVÄ SUOJAKOSKETTIMILLA VARUSTETTUUN PISTORASIAAN.
- APPARATET SKAL TILSLUTTETES JORDET STIKKONTAKT.

DÉCLARATION DE CONFORMITÉ

Nom du fabricant : BSS Audio
Adresse du fabricant : 10653 S. River Front Parkway, Suite 300 South Jordan, Utah 84095, ÉTATS-UNIS

Ce produit appartenant à la catégorie Matériel audio professionnel, il n'est pas concerné par la directive 2005/32/CE ou par le règlement européen 1275/2008 du 17 décembre 2008.

déclare que le produit :

Nom du produit : BLU 120, BLU 160, BLU 320, BLU 325, BLU 326, BLU 800, BLU 805 and BLU 806

Remarque : Nom du produit peut être suffixé par une combinaison des lettres de l'UE, M ou V.

C. Rex Reed
Directeur, Ingénierie
Traitement des signaux
10653 S. River Front Parkway, Suite 300
South Jordan, Utah 84095, ÉTATS-UNIS
Date : 15 août 2016

Contactez européenne :

Harman International
Salisbury House
London Wall
EC2M 5QQ
+44 207 562 9450

Option du produit : Divers I / O Cartes

est conforme aux spécifications suivantes :

Sécurité : CEI/IEC 60065:2001 + Amd 1 et 2

CEM : EN 55022:2010
EN 55024:2010
Partie 15 des FCC

Informations complémentaires :

Ce produit est conforme aux exigences suivantes :
Directive sur la basse tension 2014/35/UE
Directive 2014/30/UE
Directive RoHS 2011/65/UE
Directive DEEE 2012/19/UE

ou

Harman Professional Inc
10653 S. River Front Parkway, Suite 300
South Jordan, Utah 84095, ÉTATS-UNIS
Tél. : (801) 566-8800
Fax : (801) 568-7583

DÉCLARATION DE CONFORMITÉ

Nom du fabricant : BSS Audio
Adresse du fabricant : 10653 S. River Front Parkway, Suite 300 South Jordan, Utah 84095, ÉTATS-UNIS

Ce produit appartenant à la catégorie Matériel audio professionnel, il n'est pas concerné par la directive 2005/32/CE ou par le règlement européen 1275/2008 du 17 décembre 2008.

déclare que le produit :

Nom du produit : BLU 326 (DA) and 806 (DA)
Remarque : Nom du produit peut être suffixé par une combinaison des lettres de l'UE, M ou V.

C. Rex Reed
Directeur, Ingénierie
Traitement des signaux
10653 S. River Front Parkway, Suite 300
South Jordan, Utah 84095, ÉTATS-UNIS
Date : 14 mars 2017

Option du produit : Divers I / O Cartes

est conforme aux spécifications suivantes :

Sécurité : CEI/IEC 60065 : 8e éd. 2014

CEM : EN 55032 : 2012
EN 55024 : 2010
Partie 15 des FCC

Informations complémentaires :

Ce produit est conforme aux exigences suivantes :
Directive sur la basse tension 2014/35/UE
Directive 2014/30/UE
Directive RoHS 2011/65/UE
Directive DEEE 2012/19/UE

Contactez européenne :

Harman International
Salisbury House
London Wall
EC2M 5QQ
+44 207 562 9450

ou

Harman Professional Inc
10653 S. River Front Parkway, Suite 300
South Jordan, Utah 84095, ÉTATS-UNIS
Tél. : (801) 566-8800
Fax : (801) 568-7583

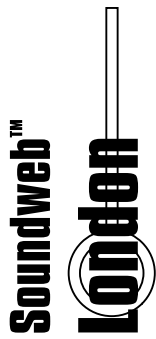

Table of Contents

Product Registration/Warranty	1
Mechanical Installation.....	1
Front Panel	2
Input Card Monitoring	2
Clip.....	2
Signal.....	2
Sync/48V	2
Conductor [BLU-800/BLU-320/BLU160/BLU-120]	
Master [BLU-805/BLU-806 (DA)/BLU-325/BLU-326 (DA)]	2
Network Link	2
Data Activity	2
LCD Display	2
LOCATE	2
Contrast (Hold)	2
Rear Panel	3
AC Mains.....	3
CobraNet™ Connectors–Primary/Secondary [BLU-800/BLU-320]	3
AVB [BLU-805/BLU-325].....	3
Dante™/AES67 [BLU-806 (DA)/BLU-326 (DA)].....	3
BLU link	3
Locate.....	4
RS232	4
Ethernet.....	4
Word Clock	
[Buddy Link or 48k] [BLU-800/BLU-805/BLU-806 (DA)/BLU-320/BLU-325/BLU-326 (DA)]	4
Audio Cable Wiring	4
Audio Input & Output Wiring Convention	4
I/O Card Positions A, B, C & D.....	5
Control Inputs.....	5
2-Wire Mode	5
3-Wire Mode	5
Logic Outputs	6
Opto Output.....	6
Technical Specifications.....	7



Product Registration/Warranty

To register your product, please visit http://bssaudio.com/en-US/support/warranty_registration.
For warranty information, please visit http://bssaudio.com/en-US/support/warranty_policy.

Mechanical Installation

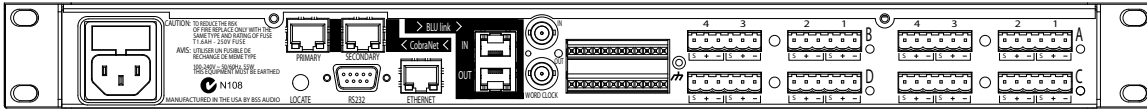

If the unit is likely to undergo extreme vibration through extensive road trucking and touring, the unit must be supported at the rear and/or sides to lessen the stress on the front mounting flange. The necessary support can generally be bought ready-built as a rack tray, or the BLU-800/805/806 (DA)/320/325/326 (DA)/160/120 unit can be mounted between other units. Damage caused by insufficient support is not covered by the warranty. To prevent cosmetic damage to the front panel finish, use protective plastic cups under the rack mounting bolts.

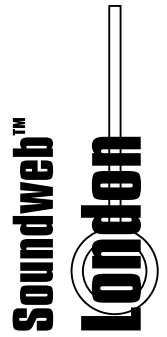

Front Panel

Input Card Monitoring

Each channel has 3 LED indicators showing:

- **Clip**
Illuminated—Indicates clipping in the analogue domain for each channel of the fitted Input or Output card. The LED will illuminate at +18.5dB.
- **Signal**
Illuminated—The Signal LED will illuminate for each channel of a fitted Input or Output card when the signal reaches or exceeds the signal threshold of -20dB.
- **Sync/48V**
Illuminated—Illuminates to indicate +48V phantom power has been activated for the relevant channel of a fitted input card. Also indicates sync status for digital I/O card.



Conductor [BLU-800/BLU-320/BLU160/BLU-120] Master [BLU-805/BLU-806 (DA)/BLU-325/BLU-326 (DA)]

The master clock device of a CobraNet™ system is referred to as the Conductor—the CM-1 modules in the system auto-negotiate which device will transmit the Conductor beat packet. The LED illuminates to indicate which device is acting as the Conductor. The master clock device of an AVB or Dante™ system is indicated with a Master LED on the front panel of the device that is providing the master clock function.

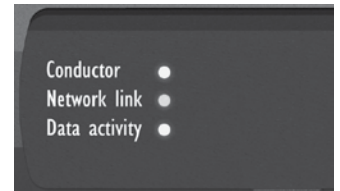

Network Link

The Network Link indicates the presence of Cat 5 Ethernet cables. If no cables are connected, the LED is unlit; the LED flashes if either a control or CobraNet™/AVB/ Dante™ cable is fitted and remains illuminated if both cables are connected.

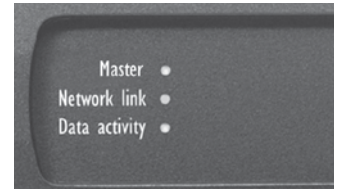

Data Activity

The Data Activity LED will flash to indicate that the device is communicating with another control device, either on the network or via the serial or control ports.

LCD Display

Top line Indicates device name and run state. Bottom line indicates Time, IP Address, Subnet Mask, and Model number with firmware version. Also, the device's MAC Address can be viewed by powering the device on whilst pressing and holding the Locate switch.

LOCATE

Pressing the Locate switch on the front of the unit will illuminate the Locate switch on the rear and identify the device within London Architect. Similarly the switch will illuminate if the device is selected from within London Architect or from the Locate switch on the rear.

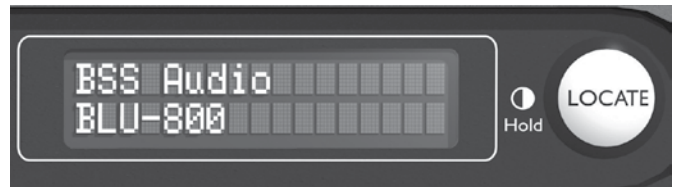

Contrast (Hold)

Pressing and holding the Locate switch will cycle the LCD through its contrast range.

Rear Panel

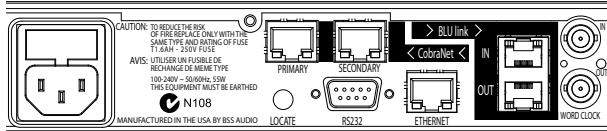

BLU-800 shown above. BLU-320 layout is identical. BLU-160 and BLU-120 have no CobraNet™ or WORD CLOCK BNC connectors, but are otherwise identical to the BLU-800 and BLU-320.

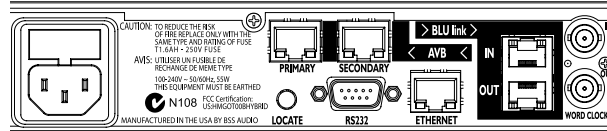

BLU-805 shown above. BLU-325 layout is identical.

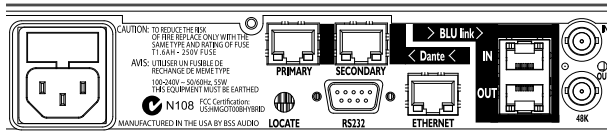
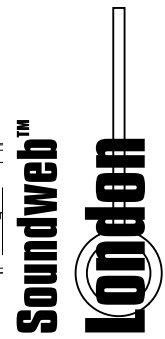

BLU-806 (DA) shown above. BLU-326 (DA) layout is identical.

AC Mains

AC Mains input to the universal switched-mode power supply, operates over a wide range of AC input voltages from 100V to 240V, 50/60Hz.

CobraNet™ Connectors—Primary/Secondary [BLU-800/BLU-320]

CobraNet™ is a licensed technology which allows CobraNet™ enabled Soundweb London devices to send and receive (simultaneously) up to 32 channels of audio to and from other CobraNet™ enabled devices. The CobraNet™ compatible devices within the Soundweb™ London system are fitted with a Peak Audio Cobranet™ CM-1 module. The module itself offers a Primary and a Secondary Cobranet™ port. Under normal operation, only the Primary port transmits and receives data to and from the network. Should the Primary port or connection fail, the CM-1 module automatically switches to receive from and transmit with the Secondary port.

AVB [BLU-805/BLU-325]

Ethernet AVB, or Audio/Video Bridging, is a common name for a set of IEEE standards that ensure the transmission of high quality streaming audio and video over a standard Ethernet connection. The BLU-805 and BLU-325 devices are fitted with an AVB module. The module allows Soundweb London devices to send and receive (simultaneously) up to 64 channels of audio to and from other AVB-enabled devices.

The module offers a Primary and a Secondary AVB port. Under normal operation, only the Primary port transmits and receives data to and from the network. Should the Primary port or connection fail, the AVB module automatically switches to receive from and transmit with the Secondary port. NOTE: The Secondary port is not currently enabled. It will be enabled in a future release of HiQnet London Architect. The physical AVB connections must be made using Cat 5e cables and an AVB compatible network switch. See 'Technical Specifications' for compatible Ethernet Switches. Do not connect the AVB ports to any switch which does not support AVB! When connecting only two AVB devices together, a direct connection between devices can be made from the primary of one device to the primary of the other.

Dante™/AES67 [BLU-806 (DA)/BLU-326 (DA)]

Dante™ is a licensed technology from Audinate®. It uses standard Internet Protocols over 100Mb and/or Gigabit Ethernet and is capable of transporting professional quality, low-latency audio. Dante™ runs on inexpensive off-the-shelf computer networking hardware and does not require dedicated network infrastructure; Ethernet switches transmit Dante™ digital media streams alongside ordinary data traffic. The BLU-806 (DA) and BLU-326 (DA) devices are fitted with a Dante™ module. The module allows Soundweb London devices to send and receive up to 64X64 channels of audio at 48 kHz (up to 32X32 channels at 96 kHz) to and from other Dante™-enabled devices. The module offers a Primary and a Secondary Dante™ port.

The Secondary port can be configured for Switched or Redundant operation using the Dante Controller software. When a device is set for Redundant operation, the device will duplicate Dante audio traffic to both Primary and Secondary Ethernet ports. When a device is set for Switched operation, the Secondary Ethernet port will behave as a standard switch port, allowing daisy-chaining through the device. The physical Dante™ connections must be made using Cat 5e or Cat 6 cables when using a Gigabit network (Cat 5 may be used for purely 100Mbps networks). AES67 audio transmission is achieved through the Dante ports on the BLU-806DA and BLU-326DA only. AES67 must be transmitted at 48kHz.

BLU link

The Soundweb London digital audio bus (also informally referred to as "BLU link") is a point-to-point digital audio bus with 256 audio channels at 48K sample rate or 128 audio channels at 96K sample rate. The physical connection is made with Cat 5e cable from the OUT port of one device to the IN port of another device. The devices are connected in a daisy chain fashion continuing with the OUT port of one device connected to the IN port of the next device. Redundancy can be provided by completing the loop and connecting the OUT port



from the last device to the IN port of the first device in the chain. DO NOT connect BLU link ports to a hub, network switch, or router. All devices connected in the BLU link ring/chain must be configured for the same audio sample rate.

Locate

Pressing the Locate switch on the rear of the unit will illuminate the Locate switch on the front and identify the device within London Architect. Similarly the switch will illuminate if the device is selected from within London Architect or from the Locate switch on the front panel.

RS232

The serial port allows 3rd-party control equipment to control and monitor the Soundweb London. The Soundweb London can also send custom serial strings (in Decimal, Hexadecimal, or ASCII format) through the serial port. Therefore, the Soundweb London can control virtually any device which has a serial port and a publicly available protocol guide.

Ethernet

The main connection for the proprietary system control network. The Ethernet port allows BLU-8v2's, BLU-10's, HiQnet London Architect, iOS devices, and 3rd-party control equipment to control and monitor the Soundweb London. The Ethernet port also allows the Soundweb London to send and receive design files to and from HiQnet London Architect. The Soundweb London can also send custom Ethernet messages (UDP or TCP; in Decimal, Hexadecimal, or ASCII format) through the Ethernet port. Therefore, the Soundweb London can control virtually any device which has an Ethernet port and a publicly available protocol guide.

Word Clock

[Buddy Link or 48k] [BLU-800/BLU-805/BLU-806 (DA)/BLU-320/BLU-325/BLU-326 (DA)]

On CobraNet™ equipped Soundweb London devices, these BNC connectors allow two similarly configured Soundweb London devices to be linked together and operate as a redundant pair. A 48kHz system clock is generated at the BNC OUT port when used in this fashion. If 'Box B' ceases to receive the 48kHz system clock from 'Box A', due to power failure of 'Box A', 'Box B' will take over and begin receiving and transmitting audio over the CobraNet™ network.

These connectors can also facilitate integration with external clocks when using BLU link or Dante™, allowing the Soundweb London devices to sync to a 'house clock', a common requirement in post-production, theatre, and broadcast applications. Synchronizing the Soundweb London internal DSP processing clock to the house clock avoids having to use Sample Rate Conversion on digital signals, resulting in superior audio. The supported sync frequencies are 48 kHz, 48 kHz pull-down (47.952 kHz), 96 kHz, and 96 kHz pull-down (95.904 kHz). Please refer to the London Architect help file for more information. The sample rate at which the Soundweb London device is running will be present on the WORD CLOCK OUT.

NOTE: The BNC WORD CLOCK connectors serve no function when using AVB.

Audio Cable Wiring

All audio and control connections are made via Klippon pluggable terminal block connectors (also known as BL, Phoenix or Combicon). 6-way female Klippon connectors (part number: 32-1226) are supplied for making these connections.

Audio Input & Output Wiring Convention

Soundweb products provide cable shielding 'back from the destination' to eliminate ground loop problems. This means that the shield (S) connection on an input is grounded, whereas the shield connection on an output is floating (although connected via an internal network to ground for EMC compliance).

Balanced wiring—The convention for balanced wiring (2-core plus shield) is shown here:

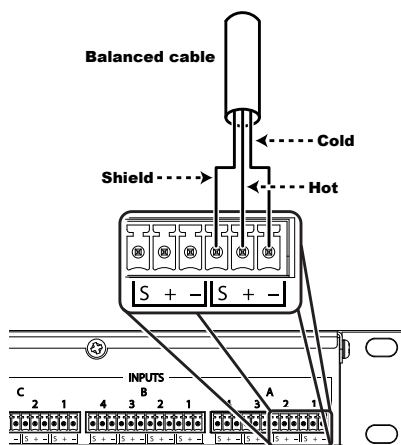

Unbalanced wiring—The convention for unbalanced wiring to the inputs (1-core plus shield) is shown here:

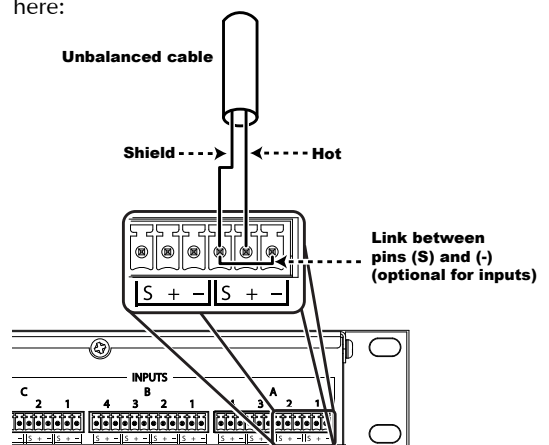

I/O Card Positions A, B, C & D

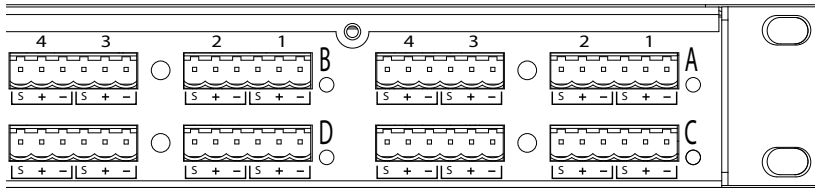

These connectors provide the balanced connections for the I/O card fitted in the four card slots in a Soundweb London device. The analogue connections are balanced, on Phoenix/Combicon connectors. A green LED next to the slot assignment letter A, B, C or D indicates that an Input card is fitted and an amber LED when an output card is fitted. Digital input cards are indicated with a blue LED and digital outputs cards with a red LED. AEC input cards are indicated with a white LED. Telephone Hybrid cards are indicated with a yellow LED.

Control Inputs

There are 12 control inputs, also known as 'General Purpose Inputs' or 'GPI'. The control inputs are used to connect contact closures (for control of binary parameters, such as mutes), resistor ladders (for control of multistate parameters, such as source selectors) or potentiometers (for control of continuous parameters, such as volume faders). There are two common (ground) connections 'C' to the left of the 12 control inputs, and two software-assignable reference voltage outputs 'R' to the right. The control ports have two modes of operation: 2-wire and 3-wire.

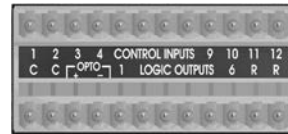

2-Wire Mode

In this mode, the 12 control inputs are internally 'pulled up' to +5V DC via a 4.7kOhm resistor. Therefore, no external voltage source is needed to create contact closure to ground for switches such as mute buttons or, resistance to ground (for other multi-state or continuous controls such as Parameter Presets or faders).

See the Soundweb London help for a table of resistor values for use with Parameter Presets or source selectors.

A 47kOhm-log potentiometer connected between a control input and common will allow parameters to be controlled linearly.

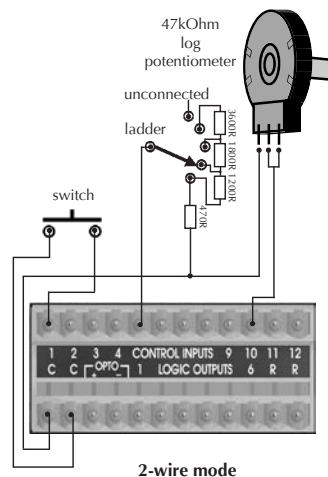

3-Wire Mode

This mode allows the use of linear pots or faders for continuous controls. A pot would be wired as a potential divider with the top of the track connected to the reference output R, the wiper to a control input and the bottom of the track to a common C. High performance pots with track resistance between 10kOhms and 100kOhms are recommended.

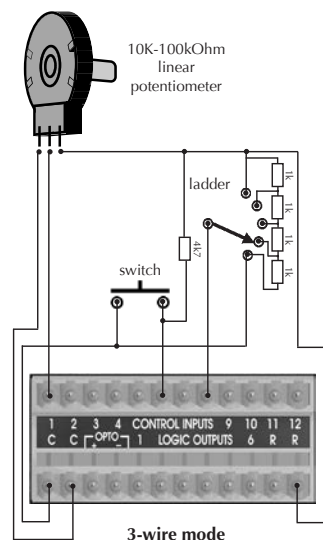

Logic Outputs

There are 6 logic outputs, also known as “General Purpose Outputs” or “GPO”. They are used to control LED’s or relays. The logic output can source 10mA at 5V DC, or sink 60mA up to 50V DC.

A high sensitivity relay (such as a reed relay) can be driven by connecting multiple logic outputs in parallel. In the diagram to the right, this arrangement will develop 4V across a 500-Ohm coil, providing that all four outputs are activated simultaneously.

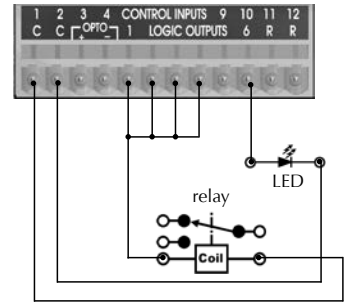

When sourcing from the Logic Output, an LED connected between one output (Anode, A) and common (Cathode, K) will illuminate when the logic output is activated, without requiring any external current limiting resistor (the Soundweb London contains an internal 440 Ohm resistor).

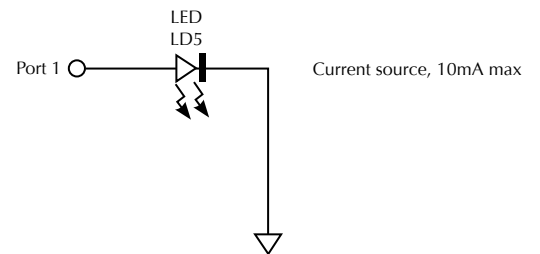

For higher current reed type relays you must use the Logic Output to sink current using an external power supply.

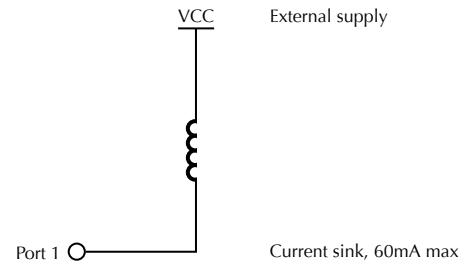

Opto Output

In addition to the six standard logic outputs, there is an isolated output, which fails safe (open circuit) if the unit becomes faulty.

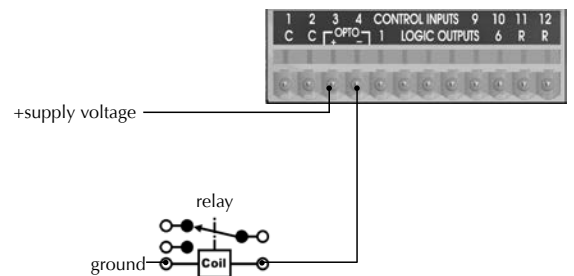

Technical Specifications

FRONT PANEL LED INDICATORS

INPUT/OUTPUT:	Per Input: Signal Present, CLIP, SYNC/48V, I/O card type [IN, OUT, DIG, AEC[BLU-800, BLU-805, BLU-806 (DA), BLU-320, BLU-326 (DA), BLU-325, BLU-160, BLU-120]
OTHER:	LCD Display, Conductor active, Net Link active, Data Activity

ANALOGUE INPUTS

CONNECTORS:	Up to 16 electronically balanced on Phoenix/Combicon removable screw connectors
MIC/LINE INPUTS:	Nominal gain 0dB, electronically switchable up to +48dB, in +6dB steps
INPUT IMPEDANCE:	3.5kOhm
MAXIMUM INPUT LEVEL:	+20dBu with 0dB input gain, [+8dBu with 12dB gain]
CMRR:	>40dB at 1kHz
EQUIV. INPUT NOISE [EINI]:	<-123dBu typ. with 150 Ohms source
PHANTOM POWER:	48V nominal, selectable per input
A/D LATENCY (REV. A):	41/Fs [0.85ms@48k, 0.43ms@96k]
A/D LATENCY (REV. B):	12/Fs [0.25ms@48k, 0.13ms@96k]
A/D BIT DEPTH:	24-bit

DIGITAL INPUTS

CONNECTORS:	Up to 16 AES/EBU or S/PDIF on Phoenix/Combicon removable screw connectors
INPUT IMPEDANCE:	110 ohm [AES/EBU], 75 ohm [S/PDIF]
SAMPLE RATE:	48kHz or 96kHz
SAMPLE RATE CONVERSION:	8kHz-96kHz
THD+N:	<-140dB
LATENCY:	3/Fso + [56.581/Fsj] + [55.658/Fso]

AEC ANALOGUE INPUTS

CONNECTORS:	Up to 16 electronically balanced on Phoenix/Combicon removable screw connectors
MIC/LINE INPUTS:	Nominal gain 0dB, electronically switchable up to +48dB, in +6dB steps
INPUT IMPEDANCE:	3.5kOhm
MAXIMUM INPUT LEVEL:	+20dBu with 0dB input gain, +8dBu with 12dB gain
CMRR:	>75dB at 1kHz
EQUIV. INPUT NOISE [EINI]:	<-128dBu typical with 150 Ohms source
PHANTOM POWER:	48V nominal, selectable per input
PRE-AEC INPUT LATENCY:	38/Fs [0.79ms@48k]
POST-AEC INPUT LATENCY:	(Original 8k Algorithm): 2385/Fs [49.68ms@48k] (Full Bandwidth Algorithm): 1609/Fs [33.52ms@48k]
TAIL LENGTH:	200 ms
CONVERGENCE RATE:	49 dB/s [Average convergence rate]

TELEPHONE INTERFACE, ANALOGUE INPUTS

CONNECTORS:	2 electronically balanced on Phoenix/Combicon removable screw connectors
MIC/LINE INPUTS:	Nominal gain 0dB, electronically switchable up to +48dB, in +6dB steps
INPUT IMPEDANCE:	3.5kOhm
MAXIMUM INPUT LEVEL:	+20dBu with 0dB input gain, +8dBu with 12dB gain, balanced, 150 ohm
CMRR:	>75dB at 100Hz, >66dB at 1kHz
EQUIV. INPUT NOISE [EINI]:	<-128dBu typical with 150 Ohms source, 20kHz, +48dB gain
PHANTOM POWER:	48V nominal, selectable per input
A/D LATENCY:	12/Fs [0.25ms@48k]

TELEPHONE INTERFACE

AC-REN:	0.0B
DYNAMIC RANGE:	67 dB
FREQUENCY RESPONSE:	300 to 3.3kHz
THD:	<0.3%
TRANSHYBRID LOSS:	>48 dB with LEC enabled
LEC TAIL TIME:	64ms
TX LEVEL:	-10dBm RMS average
RX LEVEL:	+3.2dBm RMS

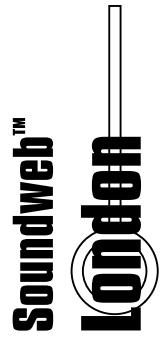

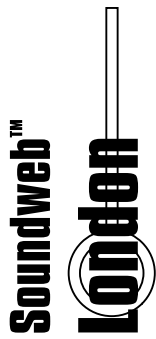

ANALOGUE OUTPUTS

CONNECTORS:	Up to 16 electronically balanced on Phoenix/Combicon removable screw connectors
OUTPUT IMPEDANCE:	40 Ohms balanced, 20 Ohms unbalanced
MAXIMUM OUTPUT LEVEL:	+19dBu
FREQUENCY RESPONSE:	20Hz to 20kHz [+0.5/-1dB]
THD:	<0.01% [20Hz to 20kHz, +10dBu output]
DYNAMIC RANGE:	108dB typ. [22Hz to 22kHz unweighted]
CROSSTALK:	<-75dB
D/A LATENCY:	28/Fs [0.58ms@48k, 0.29ms@96k]
D/A BIT DEPTH:	24-bit

DIGITAL OUTPUTS

CONNECTORS:	Up to 16 AES/EBU or S/PDIF on Phoenix/Combicon removable screw connectors
OUTPUT IMPEDANCE:	110 ohm [AES/EBU], 75 ohm [S/PDIF]
SAMPLE RATE:	48kHz or 96kHz
SAMPLE RATE CONVERSION:	8kHz-96kHz
THD+N:	<-140dB
LATENCY SRC OFF:	6/Fs [0.13ms@48k, 0.06ms@96k]
LATENCY SRC ON:	60/Fs [1.25ms@48k, 0.63ms@96k]

CONTROL PORTS

NUMBER OF PORTS:	12 inputs and 6 outputs
CONTROL INPUT VOLTAGE:	0 to 4.5v
CONTROL INPUT IMPEDANCE:	4.7kOhms to +5V [2-wire mode] >1MOhm [3-wire mode]
LOGIC OUTPUT VOLTAGE:	0 or +5V unloaded
LOGIC OUTPUT IMPEDANCE:	440 Ohm
LOGIC OUTPUT CURRENT:	10mA source, 60mA sink

WATCHDOG OUTPUT

CONNECTOR:	Phoenix/Combicon connector for failsafe control
OPTO OUTPUT CURRENT:	14mA maximum
WITHSTANDING VOLTAGE:	80V maximum [Off]
SERIES IMPEDANCE:	220 Ohms [isolated]

CONTROL NETWORK

CONNECTORS:	RJ45 Ethernet connector
MAXIMUM CABLE LENGTH:	100m/328ft on Category 5 cable between device and Ethernet switch

BLU LINK AUDIO NETWORK (IBLU-800, 320, 160, 120)

CONNECTORS:	2 x RJ45 Ethernet connectors
MAXIMUM CABLE LENGTH:	100m/328ft on Category 5e cable between devices
LATENCY:	11/Fs [0.23ms@48k, 0.11ms@96k]
PASS THROUGH LATENCY:	4/Fs [0.08ms@48k, 0.04ms@96k]

COBRANET™ AUDIO NETWORK (IBLU-80, 32, 800, 320)

CONNECTORS:	2 x RJ45 connectors
MAXIMUM CABLE LENGTH:	100m/328ft on Category 5 cable between device and Ethernet switch
LATENCY:	1.33ms-5.33ms

DANTE/AES67 AUDIO NETWORK (IBLU-806 (DA), 326 (DA))

CONNECTORS:	2 x RJ45 connectors
MAXIMUM CABLE LENGTH:	100m/328ft on Category 5 (100Mbps) or Category 5e/Category 6 (Gigabit) cable between devices
LATENCY:	0.15ms-5.0ms

AVB AUDIO NETWORK (IBLU-805, 325)

CONNECTORS:	2 x RJ45 connectors
MAXIMUM CABLE LENGTH:	100m/328ft on Category 5e cable between device and AVB compliant Ethernet switch
SAMPLE RATE:	48kHz
LATENCY:	0.5ms-2.0ms
COMPATIBLE AVB SWITCHES:	BSS Audio/NETGEAR GS724T Ethernet Switch LABX Titanium 411 Ruggedized AVB Ethernet Bridge Switch



POWER/TEMPERATURE

MAINS VOLTAGE:	100-240V AC, 50/60Hz
POWER CONSUMPTION:	<35VA [BLU-80, 32, 16]; <55VA [BLU-800, 805, 806 (DA), 320, 325, 326 (DA), 160, 120]
BTU RATING:	<120 BTU/hr [BLU-80, 32, 16]; <188 BTU/hr [BLU-800, 805, 806 (DA), 320, 325, 326 (DA), 160, 120]
OPERATING TEMPERATURE RANGE:	0° to 45° C [32° to 113° F]

PHYSICAL (BLU-120/160/320/325/326 (DA)/800/805/806 (DA))

RACK SPACE:	1U
DIMENSIONS (H X W X D):	1.75" x 19" x 12.5" (45mm x 483mm x 318mm)
WEIGHT:	9 lbs / 4.1 kgs (estimated)

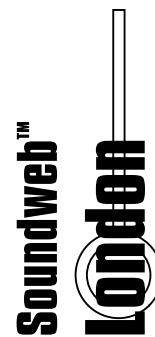

BSS Audio incorporates high quality mechanical fans in some products. All mechanical fans have a limited life expectancy. We recommend annual inspection of fans for dust occlusion and excessive noise. Fan assemblies should be replaced after six to ten years of use. Environmental factors such as elevated temperature, dust, and smoke can adversely affect fan life. Systems exposed to these conditions should be inspected more frequently. Fan replacement can be performed either at the factory or by an experienced technician in the field. Please contact BSS Technical Support for more information on purchasing replacement parts or product service.

BSS Audio has a policy of continued product improvement and accordingly reserves the right to change features and specifications without prior notice.





Phone: (801) 566-8800

Website: bssaudio.com

Support: bssaudio.com/en-US/support

BSS Audio is a registered trademark of HARMAN

© 2017 HARMAN

All rights reserved

Printed in Malaysia