



# VERSA-4K

AV Over IP

4K Video Over IP

USB 2.0 Over IP + Keyboard & Mouse

Bidirectional Audio, RS232 & IR Passthrough

Dynamic Virtual Matrix™

Part Number	Function
VERSA-4K-S	Encoder/Sender
VERSA-4K-R	Decoder/Receiver

UMA1283- Rev

CUSTOMER  
SUPPORT  
INFORMATION

Order toll-free in the U.S. 800-959-6439  
FREE technical support: 714-641-6607 or support@hallresearch.com  
**Hall Research**, 1163 Warner Ave. Tustin, CA 92780  
www.hallresearch.com

**Table of Contents**

Introduction .....5

Application.....5

Package Contents .....6

Accessories.....6

Input and Outputs.....7

Getting Started .....8

Control Interface .....9

    Front Panel Operation .....9

    IR Remote Controller .....10

        IR Detectors and Emitters .....10

    WEB-GUI.....11

    PC-GUI.....12

Working.....13

    Architecture .....13

        Unicast Mode v/s Multicast Mode.....13

    General Settings .....14

        Device Name .....14

        Group ID .....14

    Auto IP .....14

    Independent Routing .....14

    Video Over IP .....15

        Encoder Settings.....15

        EDID Management .....15

    Video Scaler.....16

        Scaler Settings.....16

    Video Wall.....16

        Video Wall Settings.....18

Bezel and Gap Compensation ..... 18

OSD ..... 18

    OSD Settings ..... 18

Audio Over IP ..... 19

    Audio Modes ..... 20

USB Over IP ..... 20

    USB Settings ..... 21

Keyboard and Mouse ..... 21

Serial Over IP ..... 22

    RS-232 Modes ..... 22

IR Over IP ..... 22

    IR Modes ..... 23

Default Configuration ..... 24

Firmware Update ..... 25

Specifications ..... 26

    HDMI Video Resolution Support List ..... 28

        VIC Timings ..... 28

        Other Timings: ..... 30

    HDMI Audio Format Support List ..... 36

    USB 2.0 Supported Class List ..... 36

    RS-232 Supported Baud rate List ..... 36



#### FCC Notice

This device complies with Part 15 of the FCC Rules. Operation is subject to the following conditions:

1. This device may not cause harmful interference.
2. This device must accept any interference even if it causes undesired operation.

This equipment has been designed to comply with the limits for a Class A digital device, pursuant to Part 15 of the FCC Rules. These limits are designed to provide reasonable protection against harmful interference when the equipment is operated in a commercial environment. This equipment generates, uses, and can radiate radio frequency energy, and if it is not installed and used in accordance with the instruction manual, it may cause harmful interference to radio communications. Operation of this equipment in a residential area is likely to cause harmful interference, in which case the user will be required to correct the interference at his own expense.

## Introduction

VERSA-4K is a complete AV over IP solution, which can extend 4K video with one frame latency, four USB 2.0 Devices with additional Key board and mouse, Bidirectional IR, Full Duplex RS-232, and Bidirectional analog audio, all in 1G Ethernet Network.

VERSA uses visually lossless compression and has inbuilt Video Scaler and Video Wall support, which makes it one stop scalable solution for the today's AV needs

See [Specifications](#) for More details.

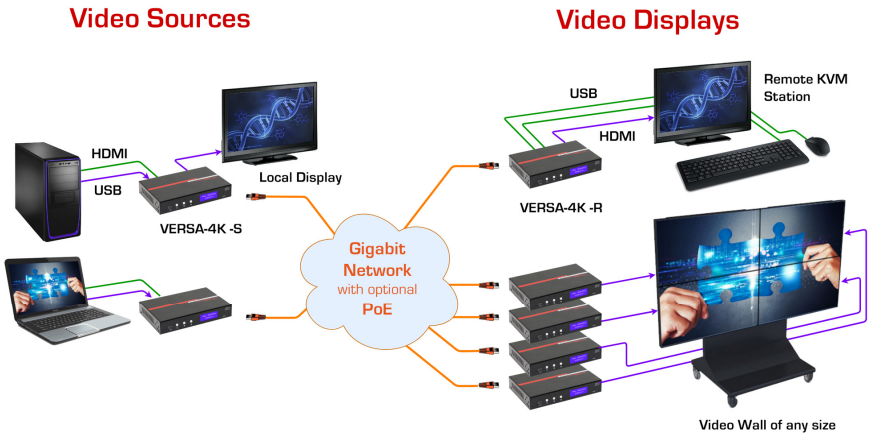



**Fig 1: Block Diagram**

## Application

- Remote PC management
- Digital Signage
- Interactive Classrooms
- Surveillance
- Live broadcast
- AV distribution
- Conference rooms, Auditoriums, Bars and restaurants

**Package Contents**

Model	Item	Quantity
<p><b>VERSA-4K-S</b></p>	<p>VERSA-4K-S User Manual Wide Band IR Emitter Side Brackets Universal Power Supply</p>	<p>1 1 1 1 1</p>
		
<p><b>VERSA-4K-R</b></p>	<p>VERSA-4K-R User Manual Wide Band IR Detector IR Detector (Local Control) IR Remote Controller Side Brackets Universal Power Supply</p>	<p>1 1 1 1 1 1 1</p>
		

**Accessories**

**Rack Mount**

## Input and Outputs



**Fig 2: VERSA-4K-S Front and Rear panel**



**Fig 3: VERSA-4K-S Front and Rear panel**

<b>Front Panel</b>	FW	USB Mini for Front Panel Firmware update
	MENU, UP, DOWN	User Buttons for front panel operation
	RST	Factory Reset
	LCD	16x2 Character display for System Configuration
<b>Rear Panel</b>	1000BT	RJ45 Jack -- Connects to 1G Ethernet
	IR-CTRL	IR Local Control
	IR-IN, IR-OUT	IR Detector and IR Emitter connections for Bidirectional Pass-through
	L/R IN, L/R OUT	3.5mm Jack for Analog Line Input and Line Output
	HDMI AUD	HDMI Audio extraction
	MIC IN	3.5mm Jack for Microphone Analog Input
	HDMI OUT	Video Output
	HDMI IN	Video Input
	RS-232	RS-232 Phoenix connector for full duplex serial communication
	USB HOST	USB Type B that connects to host PC
	USB 1.1, USB2.0	USB Type A for USB peripherals
5V DC	External Power Supply with Locking connector	

## Getting Started

1. Use Gigabit Switch with IGMPV2 and Jumbo Frame Support
2. Connect Sender(s) and Receiver(s) to the switch. No DHCP server required, by default [Auto IP](#) is enabled.
3. If switch does not support PoE, use external power supply include in the package
4. Assign unique [Group ID](#) to each Sender. Group ID can be changed from the [Front Panel](#) using UP and DOWN arrow keys or by using IR Remote Controller (See [Front Panel operation](#) for more details)
5. Connect HDMI Source(s) to Sender(s)
6. Connect HDMI Display(s) to Loop out as required
7. Connect HDMI Display(s) to Receiver(s)
8. Connect [IR Detector](#) cable to "IR-CTRL" port to use IR Remote Controller as required
9. If extending bidirectional IR, connect IR Emitter cable to "IR-OUT" port and IR detector cable to "IR-IN" port of both Sender and Receiver. See [IR Over IP](#) for more details.
10. If Using RS-232, connect RS-232 cable from PC or automation system to the supplied phoenix connector, and then connect it to the "RS-232" port of VERSA. See [Serial over IP](#) for more details.
11. To control the unit from WEB-GUI or PC-GUI change the IP address of PC to the [Auto IP](#) network
12. Assign [Device Name](#) to Sender(s) and Receiver(s) from WEB-GUI or PC-GUI



## Control Interface

### Front Panel Operation

VERSA features a 16X2 Character LCD and with three user buttons: **MENU**, **UP** and **DOWN** on the front panel, which allows the user to quickly change the [Group ID](#) and IP configuration. By default, VERSA displays [Device Name](#) and Group ID on the Home Screen, **UP** and **DOWN** arrow keys can be used change the Group ID.

In general, to change a configuration from the front panel is 5 step process:

1. Press **MENU** button on Home Screen
2. Use **UP** and **DOWN** arrow keys to navigate to a configuration.
3. Hold the **MENU** button till the Configuration starts blinking.
4. Use **UP** and **DOWN** arrows keys to see the available Options/Settings.
5. Press **MENU** again to apply the new configuration.

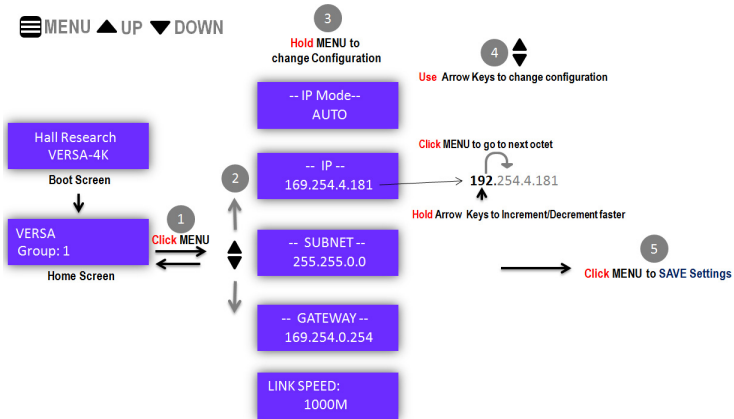

Fig 4: Front Panel Operation

#### LCD Notations:

-- [Configuration Name]-- [Status Name]:	System Configuration System Status
---	---------------------------------------

Configuration Name	Options
IP Mode	AUTO, DHCP, STATIC
IP ADD	IP Address

## VERSA-4K

SUBNET	Subnet Mask
GATEWAY	Gateway
BAUD	RS-232 Baud Rate
USB 2.0 (Receiver Only)	Used to the Connect/Disconnect with Sender in the same group

Status Name	Description
MAC ADD	Mac Address of the Device
USB RX IP (Sender Only)	Shows the IP address of the Receiver to which USB is connected
USB TX IP (Receiver Only)	Shows the IP address of the Sender to which USB devices are exported
LINK SPEED	Ethernet Link Speed (Shows 1000M when connected to 1G network) Shows "No Link!" when Physical Link is down or IP address is not assigned

### IR Remote Controller



IR Remote controller can be used to change the [Group ID](#) of Sender/Receiver. The numeric key pad on the remote controller can be used to key-In 4 digit Group ID (0000 to 9999). To use IR Remote Controller, connect IR Detector Cable, which is labeled as "Control" to "IR-CTRL" port of VERSA. See [IR Detectors and Emitters](#) for more information.



Fig 5: IR Remote Controller

### IR Detectors and Emitters

IR Detector cable for Passthrough. Connected to "IR-IN" port of VERSA.	
--	---

<p>IR Detector cable for Local Control . Connected to "IR-CTRL" port of VERSA</p>	
<p>IR Emitter cable for Passthrough. Connected to "IR-OUT" port of VERSA</p>	

### WEB-GUI

VERSA hosts a WEB Application with intuitive Graphical User Interface (GUI) , which can be accessed using any standard WEB browser. WEB-GUI can be used to change various systems setting such as [Device Name](#), [Group ID](#), [USB Control](#), [Audio Control](#), [Video Wall](#), [Independent Routing](#) and [Firmware Update over HTTP](#) etc.

For more advance configurations such as USB Filtering and USB device View use [PC-GUI](#)

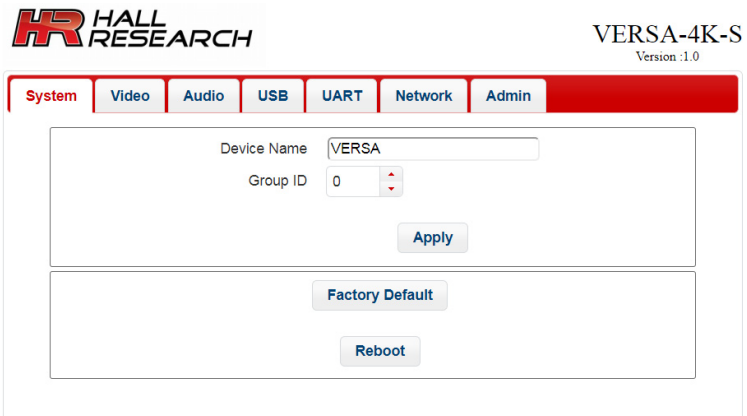

**Fig 6: VERSA-4K-S WEB-GUI**

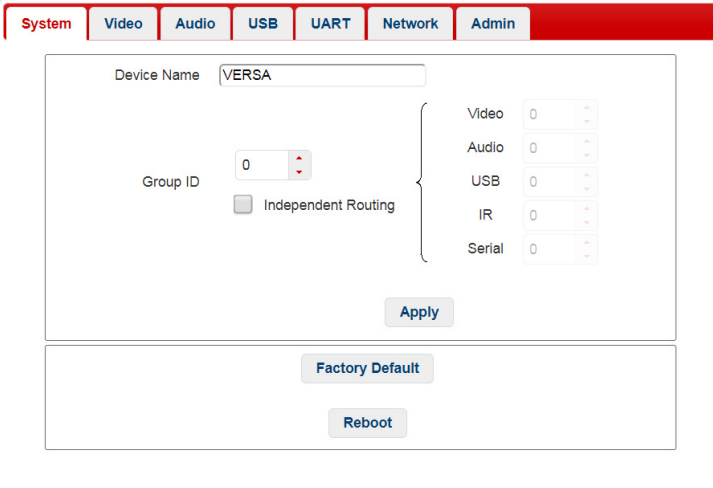

Fig 7: VERSA-4K-R WEB-GUI

### PC-GUI

PC-GUI is used to configure all the advanced settings, such as [USB Filtering](#), [OSD](#), EDID Management, [SOIP](#), and [Bezel and Width Compensation](#). With advanced device finder, PC-GUI gives an advanced top level management interface to control all the VERSAs on the network. PC-GUI can provides Video Preview, USB Device View, Matrix View etc in real time.

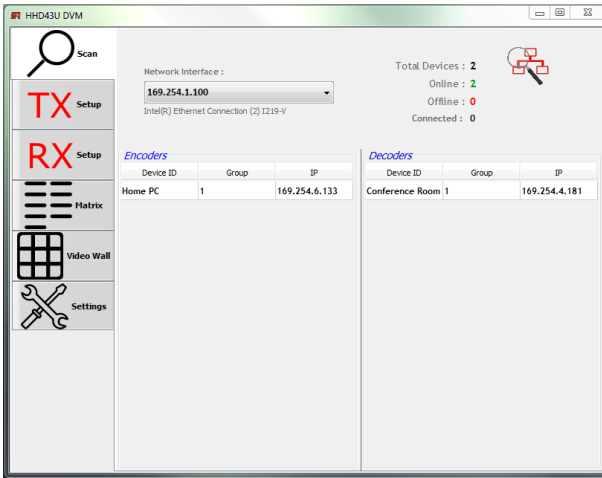

Fig 8: VERSA-4K-R PC-GUI

## Working

### Architecture

VERSA uses Client-Server architecture, where each function such as Video, Audio, USB, IR, RS-232 is considered as a service. VERSA-4K-S (Sender) being a server, provides services independently under one [Group ID](#). Each VERSA-4K-R (Receiver) in the network acts a client and receives a service by joining in the group using [Group ID](#).

A Receiver should have the same Group ID as sender to receive a service. Among all the services only USB 2.0 is mutually exclusive. This means only one receiver in a group can exclusively connect with the sender in order to export its USB Devices. See [USB over IP](#) for more Details.

### Unicast Mode v/s Multicast Mode

Unicast is used in One-to-One Applications, where only one receiver is allowed in a group. Unicast offers simple and secure ways to extend Video and USB applications, such as Remote PC Control, Classroom Presentation system with touch screen.

Unlike Unicast, Multicast mode is used in One-to-Many Applications, where multiple receivers can join in a group and request services from a sender. Multicast gives true flexibility to scale the system and offers features like [Independent Routing](#) and [Video Wall](#).

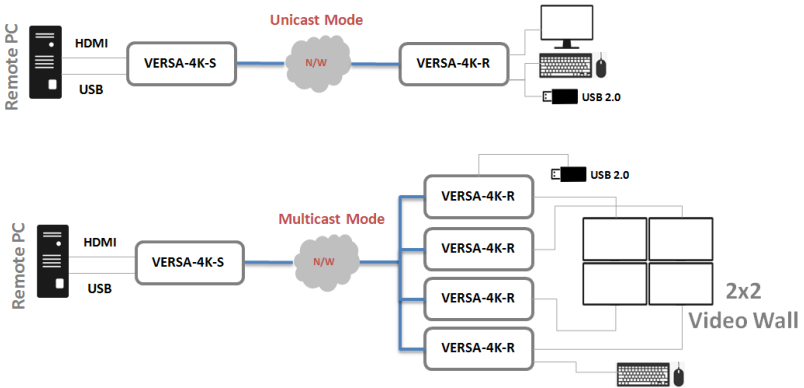

Fig 9: Unicast and Multicast Mode

## General Settings

### Device Name

User can assign Device Name to VERSA, which can be used to identify its Location or Purpose. Device Names are useful for Logical representation of the system in big installations and they are not linked to IP address. For instance, all the Receivers connected to the projectors in a school can have Room Number as Device Name. By default the Device Name is set to "VERSA" for both sender and Receiver.

### Group ID

In VERSA's [architecture](#), each service from a Sender is served on Multicast IP. Group ID is a simpler representation of Multicast IP. Each Sender needs to have a unique Group ID on the network. A Group ID Ranges from 0000 to 9999, which allows scaling the system up to 10,000 Senders in one network. A Receiver can receive a service from a sender by having the same Group ID. In multicast mode multiple Receivers can join in the same group, and can multiplex various services from Senders in different groups, which is also called as [Independent Routing](#).

### Auto IP

Auto IP, is also called as Automatic Private IP Addressing (APIPA) is a method where a device on a network assigns itself an unique IP address in the absence of a DHCP Server. An Auto IP device, such as VERSA holds an IP address in the range of **169.254.x.y** in Auto IP Mode, where : **x,y** can range from 0 to 255.

By default Auto IP is enabled in VERSA. To access the device WEB-GUI or to control the device with PC-GUI, the User's PC should be in the following network:

<b>IP Address</b>	169.254.x.y	Where: x = 0 - 255 y = 0 -255
<b>Subnet</b>	255.255.0.0	

### Independent Routing

Independent Routing featured in the VERSA-4K-R (Receiver) gives the flexibility to multiplex various services from multiple Senders. For example, a Receiver can receive video form Group-1, Audio from Group-2 and USB from Group-3 as shown below.

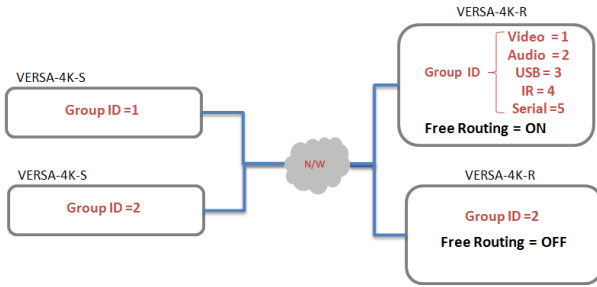

**Fig 10. Independent Routing**

Note that, Audio only works when there is a active Video Group.

### Video Over IP

VERSA-4K-S uses visually lossless compression to encode 4K Video. Along with bit rate and Frame rate adjustments, Sender provides Various Quality modes and Bit Rate adjustments to minimize the network bandwidth.

#### Encoder Settings

<b>Bit Rate</b>	Best Effort	VERSA takes complete freedom to deliver best quality content with less compression. A typical 1080@60 video can take up to 200Mbps bandwidth
	10 - 200Mbps	This forces the encoder to compress more to meet the selected video bandwidth requirement
<b>Frame Rate</b>	0 - 100%	Can be used to minimize the bandwidth by reducing the number of frame that needs to be encoded. Low frame rate can be used for Static Image Videos
<b>Quality Mode</b>	Video Mode	More priority to Frame Rate over Video Quality
	Graphic Mode	More priority to Video Quality over Frame Rate. Some of the frames might be dropped. This mode is typically used for Static Image Videos.
	1 - 5	Higher the value lower the Video quality
<b>Anti-Dither Mode</b>	ON/OFF	Anti-Dither Mode removes the noise in the source video by averaging them with surrounding pixel data. Don't enable this if the source video is clean

#### EDID Management

VERSA-4K Sender can save up to two EDIDs. One of them is [Default EDID](#), which cannot be modified and other one is a Custom EIDD, which can be updated from Receiver end. Sender always serves Custom EDID to the source, in the absence of Custom EDID it serves Default EDID.

In [multicast mode](#), a receiver in the group can send an EDID Update Request to replace Custom EIDD with its attached Sink EDID. A Receiver automatically sends an Update Request when Display is detected, if "Use this EDID" option is enabled. When multiple receivers sends an EDID update request, the last received request will be successful. In multicast scenario it is recommended to enabled "Use This EDID" option on only one receiver.

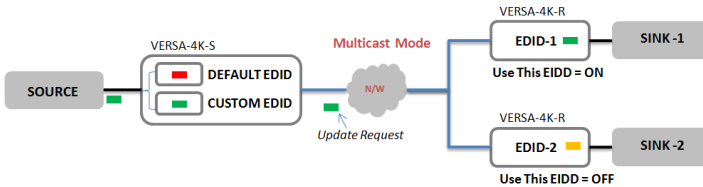

**Fig 11. EDID Management**

**Video Scaler**

VERA has inbuilt Video Scaler on each Receiver. The Scaler supports Up-scaling (Low resolution to High Resolution), Down-Scaling (High Resolution to low resolution) and Timing Conversion (Interlaced to Progressive and vice versa). See [HDMI Video resolution support list](#) for more information.

The Scaler can be set to "EDID Preferred", which will automatically scale the input video to the native resolution of the monitor as defined in its EDID. This feature provides the flexibility to use different kinds of monitors at the Receiver end regardless of brand and 4K resolution support.

**Scaler Settings**

<b>Output Timing</b>	Pass through	Output same resolution as input
	Custom Timing	See <a href="#">Resolution Support List</a>
	EDID Preferred	Automatically scales the video to the preferred EDID timing of the sink

**Video Wall**

VERSA receiver has inbuilt video wall support with Bezel and GAP compensation, Pixel Wise panning, Image Rotation and Mirroring. The Video Wall layout is a rectangular array of monitors, where the position (x', y') of a monitor on the Wall is identified with row and column number. The total number of rows indicates Vertical Monitor Count (Y) and the total number of columns indicates Horizontal Monitor Count (X).



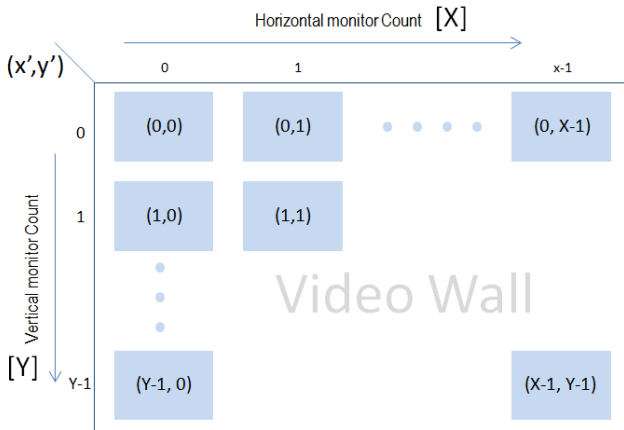

**Fig 10. Video Wall Layout**

For example, to build a 2x2 (two by two) Video Wall, which has 2 rows and 2 columns.

So, Horizontal Monitor Count [X] = 2, Vertical monitor Count [Y] =2

A total of 4 Receivers are required to build this wall and they can be positioned at: (0,0) , (0,1) , (1,0), and (1,1)

Each Receiver includes a Video Wall Preview in its WEB-GUI, which helps to visualize the wall. From the above example to the place a receiver in Top left corner of the video wall, set the Wall Size = 2x2, and select the position (0,0) as shown below.

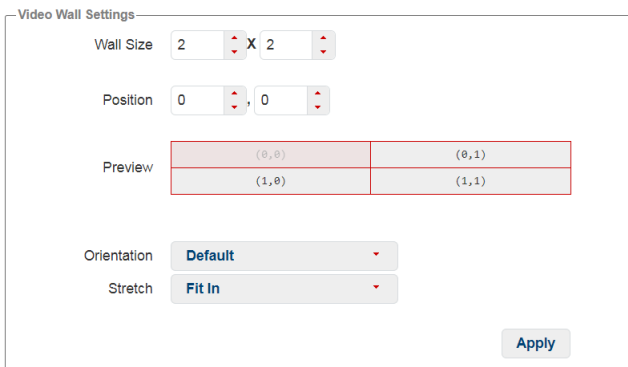

**Fig 9. Video Wall preview in Receiver WEB-GUI**

**Video Wall Settings**

<b>Wall Size</b>	[X,Y]	X = [1 to 16] Horizontal Monitor Count Y = [1 to 16] Vertical Monitor Count Set [1,1] to disable Video Wall
<b>Position</b>	(x',y')	x' =[0 to 15] Horizontal Position y' =[0 to 15] Vertical Position
<b>Orientation</b>	Default Flip Vertical/Horizontal (Mirror Image) Rotate Clock Wise (90/180/270) Rotate 90 + Flip Vertical	
<b>Stretch</b>	Fill/Fit In	

**Bezel and Gap Compensation**

<b>Scale</b>	Horizontal Scale , Vertical Scale	
<b>Shift</b>	Left, Right, Up and Down	In Pixels
<b>Bezel and Gap</b>	OW	x0.1mm
	VW	x0.1mm
	OH	x0.1mm
	VH	x0.1mm

**OSD**

VERSA-4K-R has inbuilt Hardware On Screen Display (OSD) Controller, which supports Alpha Blending and transparent settings. A Receiver can display an Image and Multi color text at any position on the screen. Use PC GUI to upload images and display text as OSD.

**OSD Settings**

<b>Position</b>	Offset in pixels	[X,Y]
	OSB predefined Presets	Top-Left/Top -Right Bottom-Left/Bottom-Right Top/Bottom/Left/Right

<b>Text</b>	Color	RGB: [x,y,z]
	Character Count	128
	Text Pixel Size	[1 to 100]
	Text Align	Center/Left
	OSD Alpha Blend (31 is no transparency)	[1 to 31]
	OSD Background	Mask ON/OFF
	Timer (In Seconds)	Always ON/ [0 to 100]

<b>Image</b>	Size	640x480
	Type	JPEG /PNG 32bpp

### Audio Over IP

VERSA Supports up to 7.1ch HDMI Audio (See [HDMI Audio Format Support List](#) for more details). The Sender also supports HDMI audio embedding from LIN IN, which is used for VGA sources.

VERSA also supports bidirectional audio pass-through in Unicast Mode, which make it ideal solution for Remote PC extension.

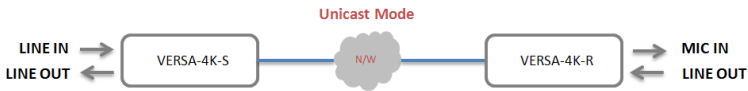

**Fig 11. Bidirectional Audio Pass-through**

In multicast Mode, Sender supports 3 **Input Modes** to select an audio source between HDMI Audio and LIN IN Audio. The selected audio source is embedded into the video and multicast to all the Receivers in the group. Also, Receiver supports 3 **Output Modes** to route audio between LINE OUT and HDMI OUT. See [Audio Modes](#) for more details.

**Note:**

1. While using [Independent Routing](#), receiver must be a part of a working video group to output the audio.
2. Bidirectional Audio Pass-through is only supported in Unicast Mode and when LINE IN is selected. (See [Audio Modes](#) for more details)

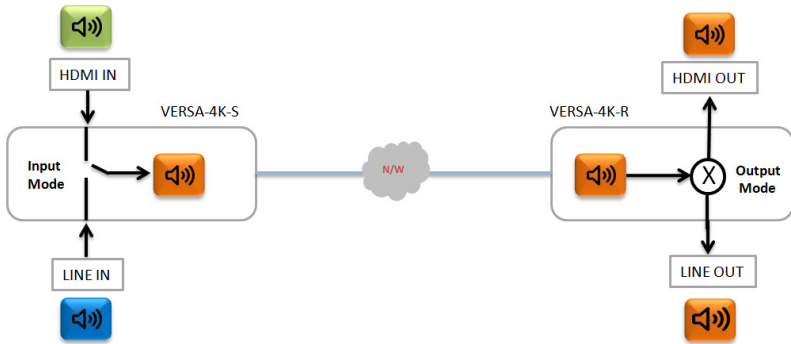

Fig 12. Audio Modes

**Audio Modes**

<b>Input Mode</b> (Only for Sender)	<b>Auto</b>	Auto Select LINE IN when Input is DVI or when LINE IN hot plug is detected
	<b>Auto 1</b>	Auto Select LINE IN when Line hot plug is detected
	<b>Auto 2</b>	Always use HDMI audio when video Input is not DVI Always use LINE IN when video Input is DVI

<b>Output Mode</b> (Only for Receiver)	<b>Dual Output</b>	Output Audio on both HDMI and LINE OUT
	<b>HDMI Only</b>	Only output audio on HDMI
	<b>Line Out Only</b>	Only output audio on LINE OUT

**USB Over IP**

The principle of USB Over IP (USB over IP) in VERSA is rather simple. A Receiver has an inbuilt USB2.0 HUB, which acts a USB2.0 Local host to all the USB devices connected to it. A Receiver needs to be paired with a Sender in order to export its USB2.0 devices to the Host PC. The Host PC always sees remote USB devices as locally attached to a HUB emulated in the Sender.

VERSA can serve up to four USB2.0 downstream devices over IP. Unlike [Keyboard and Mouse](#), each Receiver in a group should explicitly connect to a sender to export its USB2.0 devices. Receiver can setup an export policy to filter USB2.0 devices based on Class or Product ID (PID) & Vendor ID (VID). Use PC-GUI to build custom USB policy and to view the Device Tree. See [Supported USB Class List](#) for more details.

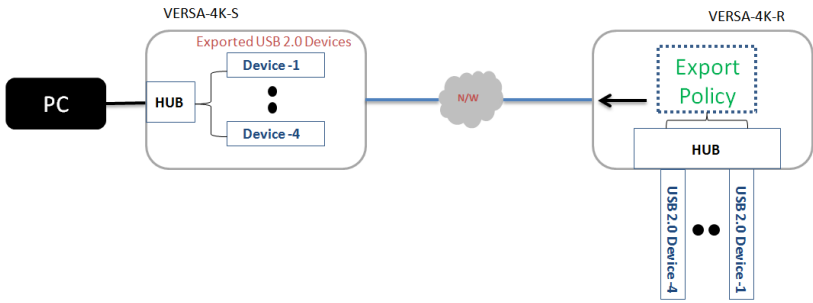

Fig 13. USB2.0 Export Policy

USB Settings

VERSA-4K-S (Sender)	<b>Attached Client IP</b>	IP Address for connected Receiver
	<b>Auto Connect to First Peer</b>	USB will be automatically connected the first receiver seen in the group (Useful when there is only one receiver in the group)
	<b>USB Incompatibility</b>	Enable when the mouse is responding slow
VERSA-4K-R (Receiver)	<b>Connect/Disconnect</b>	Initiates USB 2.0 Connect/Disconnect Request. When multiple receivers send the request only last received will be served and others will be disconnected.
	<b>Host IP</b>	IP Address of connected Sender

Keyboard and Mouse

Unlike USB2.0, Keyboard and mouse are always emulated on the host PC and no explicit connection requests or driver installation is needed. In multicast mode, a PC can be controlled using mouse and keyboard from any receiver in the group.

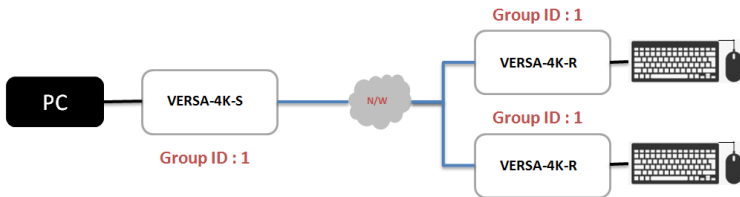
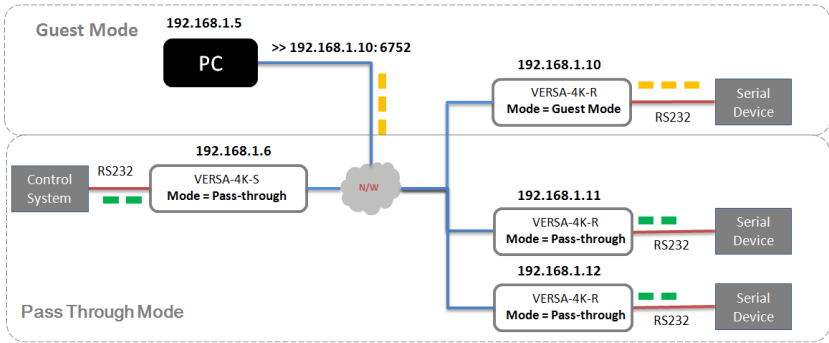

Fig 14. Keyboard and Mouse Over IP

## Serial Over IP

Both Sender and Receiver supports two types of modes to control RS-232 devices. In Pass Through mode, all the bytes from the senders are multicast to all the receivers in the group, like wise all the bytes from the receiver is directed to the sender in the group. The Guest mode allows 3rd party control systems to control serial devices over IP. In Guest mode, a control system can completely take control on the serial port and can have full duplex serial communication with attached serial devices. See [supported baud rate list](#) for more information.



**Fig 15. Serial Over IP**

### RS-232 Modes

<b>Pass Through</b>	RS-232 Pass Through mode
<b>Guest Mode (Telnet Port: 6752)</b>	Serial Over IP

## IR Over IP

VERSA Supports Bidirectional Pass-through IR along with Guest Mode. Guest mode allows 3rd party control systems to Send/Receive IR Commands over IP. Use PC-GUI to control devices using Guest Mode.

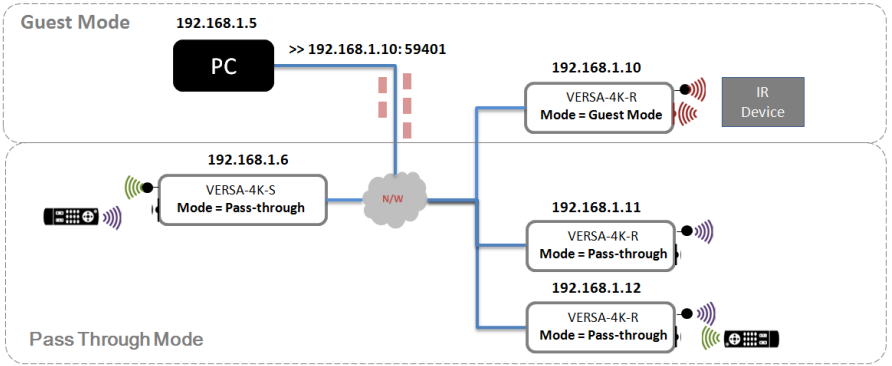

Fig 16. IR Over IP

**IR Modes**

<b>Pass Through</b>	IR Pass Through mode
<b>Guest Mode (Telnet Port: 59401)</b>	IR Over IP (Pronto hex format only).

## Default Configuration

Settings	Name	Value
Network	Casting Mode	Multicast
	IP Mode	Auto IP
	Jumbo Frame	8000 MTU
	IP	169.254.xxx.xxx
	Subnet	255.255.0.0
	Gateway	169.254.0.254
System	Device Name	VERSA
	Group ID	0000
	Independent Routing	Disabled
Encoder Settings (VERSA-4K-S Only)	Bit Rate	Best Effort
	Frame Rate	100%
	Quality Mode	Video Mode
	Anti-Dither Mode	OFF
Scalar Settings (VERSA-4K-R Only)	Output Timing	Pass through
Video Wall Settings (VERSA-4K-R Only)	Wall Size	[1x1]
	Position	(0,0)
	Orientation	Default
	Stretch	Fit In
Audio Settings (VERSA-4K-S Only)	Input Mode	Auto
	Line Input Volume	Default
	Line Out Volume	Default
Audio Settings (VERSA-4K-R Only)	Output Mode	Dual Output
	MIC Input Volume	Default
	Line Output Volume	Default
USB Settings (VERSA-4K-S Only)	Operation Mode	Auto Select Mode
	Auto Connect to first peer	Disabled
	USB Compatibility Issue	Disabled
USB Settings (VERSA-4K-R Only)	USB 2.0	Disconnected
	USB Policy	Auto Export
RS-232 Settings	Operation Mode	Pass Through
	Baud rate	115200
	Data bits, Parity, Stop Bits	8,None, 1



## Firmware Update

Steps to update firmware from WEB-GUI:

1. Accesses the Sender or Receiver WEB-GUI
2. Navigate to **Admin > Update Firmware**
3. Click on **Choose File** and Select the Binary File (**.bin**) provided by Hall Research.
4. Click Upload
5. Wait until the System finishes the Firmware Update and Reboots itself.

### Firmware Update Progress:

```
firmware file name: webfwh.bin
firmware file size: 5358914 bytes
Decompressing firmware...
Platform matched.
Start programming flash...
programming bootloader...
programming kernel...
programming rootfs...
programming rootfs patch...
programming parameters...
Programming completed
```

**DONE. Rebooting...**

## Specifications

<b>System</b>	Supports	Device Naming, IP Control Build in WEB Server with Instuitive User Interface Front panel with 16x2 Character display for System configuration IR Remote Control
	Sender	Supports Independent routing
	Receiver	Built OSD generator, which can display custom text and pictures Built in Scalar with can support: low resolution <=> High Resolution timing conversion Interlaced <=> Progressive Mode conversion
	Video Wall Support	Wall Size up to 16x16 Bezel and Gap Compensation Pixel Wise Panning Image Rotation , Mirroring, and Stretch Video Pause and Black Out
<b>Network</b>	Max Distance	120m UTP
	Bandwidth	850Mbps +- 20Mbps *Varies with video pattern, USB activity, and WEB-GUI activity
	Casting	Multicast (Groups 0 ~9999), Unicast Supports VLAN Switching
	Supports	Bit rate and bandwidth Control Static, DHCP and Auto IP (Zero Config) IGMPV2 1500 or 8000 MTU *Recommended 8K (8000MTU) for 4K video
<b>Video</b>	Sender Input	Up to 4K@60 4:4:4, HDMI 2.0a, HDR, HDCP2.2
	Sender Loop out	Up to 4K@60 4:4:4, HDMI 2.0a, HDR, HDCP2.2
	Receiver Output	Up to 4K@30 4:4:4, HDMI 2.0a, HDR, HDCP 2.2
<b>Audio</b>	HDMI Audio	2Ch, 5.1Ch, 7.1Ch LPCM 5.1Ch, 7.1Ch NLPCM
	Supports	HDMI Audio Extraction (2Ch LPCM 32Khz ~96Khz)
<b>Video Over IP</b>	Video Codec	Proprietary Visually Lossless Video Codec Supports Quality Control
	Latency	1 Frame (< 30ms)
	Supports	Video Snapshot Anti-Dithering V3, Frame Rate Control

<b>Audio Over IP</b>	Sender Analog Audio	Line In, Line Out for Audio Over IP Supports HDMI Audio Embedding
	Receiver Analog Audio	Mic In, Line Out for Audio Over IP Supports HDMI Audio De-Embedding
	Supports	Analog Volume Control Bidirectional Audio extension in Unicast mode
<b>USB Over IP</b>	USB Extension	up to 4xUSB 2.0 Downstream Devices USB 1.1 for Keyboard and Mouse Extension
	Supports	USB Class and Device Filtering Touch Screen Devices
<b>RS-232 Over IP</b>	RS-232	300 ~ 115200 bps with Data bit, parity and Stop bit settings
	Supports	Bidirectional Pass-through Mode (Dump redirection) Guest Mode (Serial Over IP over dedicated telnet port)
<b>IR Over IP</b>	IR	Universal IR
	Supports	Bidirectional IR Pass-through Mode Guest Mode (Software Decoding over dedicated telnet port)
<b>Temperature and Power</b>	POE Enabled External Power Supply	

# HDMI Video Resolution Support List

## VIC Timings

VIC	Short Name	Aspect Ratio	Pixel Ratio	Resolution (HxV@F)
1	DMT0659	4:3	1:1	640x480p @59.94/60 Hz
2	480p	4:3	8:9	720x480p @59.94/60 Hz
3	480pH	16:9	32:37	720x480p @59.94/60 Hz
4	720p	16:9	1:1	1280x720p @59.94/60 Hz
5	1080i	16:9	1:1	1920x1080i @59.94/60 Hz
6	480i	4:3	8:9	720(1440)x480i @59.94/60 Hz
7	480iH	16:9	32:37	720(1440)x480i @59.94/60 Hz
8	240p	4:3	8:9	720(1440)x240p @59.94/60 Hz
9	240pH	16:9	32:37	720(1440)x240p @59.94/60 Hz
10	480i4x	4:3	8:9	(2880)x480i @59.94/60 Hz
11	480i4xH	16:9	32:37	(2880)x480i @59.94/60 Hz
12	240p4x	4:3	8:9	(2880)x240p @59.94/60 Hz
13	240p4xH	16:9	32:37	(2880)x240p @59.94/60 Hz
14	480p2x	4:3	8:9	1440x480p @59.94/60 Hz
15	480p2xH	16:9	32:37	1440x480p @59.94/60 Hz
16	1080p	16:9	1:1	1920x1080p @59.94/60 Hz
17	576p	4:3	16:15	720x576p @50 Hz
18	576pH	16:9	64:45	720x576p @50 Hz
19	720p50	16:9	1:1	1280x720p @50 Hz
20	1080i25	16:9	1:1	1920x1080i @50 Hz*
21	576i	4:3	16:15	720(1440)x576i @50 Hz
22	576iH	16:9	64:45	720(1440)x576i @50 Hz
23	288p	4:3	16:15	720(1440)x288p @50 Hz
24	288pH	16:9	64:45	720(1440)x288p @50 Hz
25	576i4x	4:3	16:15	(2880)x576i @50 Hz
26	576i4xH	16:9	64:45	(2880)x576i @50 Hz
27	288p4x	4:3	16:15	(2880)x288p @50 Hz
28	288p4xH	16:9	64:45	(2880)x288p @50 Hz
29	576p2x	4:3	16:15	1440x576p @50 Hz
30	576p2xH	16:9	64:45	1440x576p @50 Hz
31	1080p50	16:9	1:1	1920x1080p @50 Hz
32	1080p24	16:9	1:1	1920x1080p @23.98/24 Hz
33	1080p25	16:9	1:1	1920x1080p @25 Hz
34	1080p30	16:9	1:1	1920x1080p @29.97/30 Hz
35	480p4x	4:3	8:9	(2880)x480p @59.94/60 Hz
36	480p4xH	16:9	32:37	(2880)x480p @59.94/60 Hz
37	576p4x	4:3	16:15	(2880)x576p @50 Hz
38	576p4xH	16:9	64:45	(2880)x576p @50 Hz
39	1080i25	16:9	1:1	1920x1080i @50 Hz* (1250 Total)
40	1080i50	16:9	1:1	1920x1080i @100 Hz
41	720p100	16:9	1:1	1280x720p @100 Hz
42	576p100	4:3	8:9	720x576p @100 Hz
43	576p100H	16:9	32:37	720x576p @100 Hz
44	576i50	4:3	16:15	720(1440)x576i @100 Hz
45	576i50H	16:9	64:45	720(1440)x576i @100 Hz
46	1080i60	16:9	1:1	1920x1080i @119.88/120 Hz
47	720p120	16:9	1:1	1280x720p @119.88/120 Hz
48	480p119	4:3	16:15	720x480p @119.88/120 Hz
49	480p119H	16:9	64:45	720x480p @119.88/120 Hz
50	480i59	4:3	8:9	720(1440)x480i @119.88/120 Hz
51	480i59H	16:9	32:37	720(1440)x480i @119.88/120 Hz
52	576p200	4:3	16:15	720x576p @200 Hz
53	576p200H	16:9	64:45	720x576p @200 Hz
54	576i100	4:3	16:15	720(1440)x576i @200 Hz
55	576i100H	16:9	64:45	720(1440)x576i @200 Hz
56	480p239	4:3	8:9	720x480p @239.76/240 Hz
57	480p239H	16:9	32:37	720x480p @239.76/240 Hz
58	480i119	4:3	8:9	720(1440)x480i @239.76/240 Hz
59	480i119H	16:9	32:37	720(1440)x480i @239.76/240 Hz

60	720p24	16:9	1:1	1280x720p @23.98/24 Hz
61	720p25	16:9	1:1	1280x720p @25 Hz
62	720p30	16:9	1:1	1280x720p @29.97/30 Hz
63	1080p120	16:9	1:1	1920x1080p @119.88/120 Hz
64	1080p100	16:9	1:1	1920x1080p @100 Hz
65	720p24	64:27	4:3	1280x720p @23.98/24 Hz
66	720p25	64:27	4:3	1280x720p @25 Hz
67	720p30	64:27	4:3	1280x720p @29.97/30 Hz
68	720p50	64:27	4:3	1280x720p @50 Hz
69	720p	64:27	4:3	1280x720p @59.94/60 Hz
70	720p100	64:27	4:3	1280x720p @100 Hz
71	720p120	64:27	4:3	1280x720p @119.88/120 Hz
72	1080p24	64:27	4:3	1920x1080p @23.98/24 Hz
73	1080p25	64:27	4:3	1920x1080p @25 Hz
74	1080p30	64:27	4:3	1920x1080p @29.97/30 Hz
75	1080p50	64:27	4:3	1920x1080p @50 Hz
76	1080p	64:27	4:3	1920x1080p @59.94/60 Hz
77	1080p100	64:27	4:3	1920x1080p @100 Hz
78	1080p120	64:27	4:3	1920x1080p @119.88/120 Hz
79	720p24	64:27	64:63	1680x720p @23.98/24 Hz
80	720p25	64:27	64:63	1680x720p @25 Hz
81	720p30	64:27	64:63	1680x720p @29.97/30 Hz
82	720p50	64:27	64:63	1680x720p @50 Hz
83	720p	64:27	64:63	1680x720p @59.94/60 Hz
84	720p100	64:27	64:63	1680x720p @100 Hz
85	720p120	64:27	64:63	1680x720p @119.88/120 Hz
86	1080p24	64:27	1:1	2560x1080p @23.98/24 Hz
87	1080p25	64:27	1:1	2560x1080p @25 Hz
88	1080p30	64:27	1:1	2560x1080p @29.97/30 Hz
89	1080p50	64:27	1:1	2560x1080p @50 Hz
90	1080p	64:27	1:1	2560x1080p @59.94/60 Hz
91	1080p100	64:27	1:1	2560x1080p @100 Hz
92	1080p120	64:27	1:1	2560x1080p @119.88/120 Hz
93	2160p24	16:9	1:1	3840x2160p @23.98/24 Hz
94	2160p25	16:9	1:1	3840x2160p @25 Hz
95	2160p30	16:9	1:1	3840x2160p @29.97/30 Hz
96	2160p50	16:9	1:1	3840x2160p @50 Hz
97	2160p	16:9	1:1	3840x2160p @59.94/60 Hz
98	2160p24	256:135	1:1	4096x2160p @23.98/24 Hz
99	2160p25	256:135	1:1	4096x2160p @25 Hz
100	2160p30	256:135	1:1	4096x2160p @29.97/30 Hz
101	2160p50	256:135	1:1	4096x2160p @50 Hz
102	2160p	256:135	1:1	4096x2160p @59.94/60 Hz
103	2160p24	64:27	4:3	3840x2160p @23.98/24 Hz
104	2160p25	64:27	4:3	3840x2160p @25 Hz
105	2160p30	64:27	4:3	3840x2160p @29.97/30 Hz
106	2160p50	64:27	4:3	3840x2160p @50 Hz
107	2160p	64:27	4:3	3840x2160p @59.94/60 Hz

**Other Timings:**

S/No	HA	VA	Rate	HP	VP	Pix CLOCK	Scan Mode
-- HDTV Timings --							
0	640	480	60Hz	-ve	-ve	252000	Prog
1	720	480	60Hz	-ve	-ve	270270	Prog
2	720	480	60Hz	-ve	-ve	270270 (D)	Prog
3	1280	720	60Hz	+ve	+ve	742500	Prog
4	1920	1080/2	60Hz	+ve	+ve	742500	Interl
5	1440/2	480/2	60Hz	-ve	-ve	270270/2	Interl
6	1440/2	480/2	60Hz	-ve	-ve	270270/2 (D)	Interl
7	1440/2	240	60Hz	-ve	-ve	270270/2	Prog
8	1440/2	240	60Hz	-ve	-ve	270270/2 (D1)	Prog
9	1440/2	240	60Hz	-ve	-ve	270270/2 (D2)	Prog
10	1440/2	240	60Hz	-ve	-ve	270270/2 (D3)	Prog
11	1440	480	60Hz	-ve	-ve	540450	Prog
12	1440	480	60Hz	-ve	-ve	540450 (D)	Prog
13	1920	1080	60Hz	+ve	+ve	1485000	Prog
14	720	576	50Hz	-ve	-ve	270000	Prog
15	720	576	50Hz	-ve	-ve	270000 (D)	Prog
16	1280	720	50Hz	+ve	+ve	742500	Prog
17	1920	1080/2	50Hz	+ve	+ve	742500	Interl
18	1440/2	576/2	50Hz	-ve	-ve	270000/2	Interl
19	1440/2	576/2	50Hz	-ve	-ve	270000/2 (D)	Interl
20	1440/2	288	50Hz	-ve	-ve	270000/2	Prog
21	1440/2	288	50Hz	-ve	-ve	270000/2 (D)	Prog
22	1440/2	288	50Hz	-ve	-ve	270000/2 (D1)	Prog
23	1440/2	288	50Hz	-ve	-ve	270000/2 (D2)	Prog
24	1440/2	288	50Hz	-ve	-ve	270000/2 (D3)	Prog
25	1440/2	288	50Hz	-ve	-ve	270000/2 (D4)	Prog
26	1440	576	50Hz	-ve	+ve	540000	Prog
27	1440	576	50Hz	-ve	+ve	540000 (D)	Prog
28	1920	1080	50Hz	+ve	+ve	1485000	Prog
29	1920	1080	24Hz	+ve	+ve	742500	Prog
30	1920	1080	25Hz	+ve	+ve	742500	Prog
-- HDTV with wrong polarity --							
31	1440/2	240	60Hz	+ve	+ve	270270/2	Prog
32	1440/2	480/2	60Hz	+ve	+ve	270270/2	Interl
33	1440/2	576/2	50Hz	+ve	+ve	270000/2	Interl
34	1440/2	288	50Hz	+ve	+ve	270000/2	Prog
35	720	480	60Hz	+ve	+ve	270270	Prog
36	720	576	50Hz	+ve	+ve	270000	Prog
37	1280	720	50Hz	-ve	-ve	742500	Prog
38	1280	720	60Hz	-ve	-ve	742500	Prog
39	1440	480	60Hz	+ve	+ve	540450	Prog
40	1440	576	50Hz	-ve	-ve	540000	Prog
41	1920	1080/2	50Hz	-ve	-ve	742500	Interl
42	1920	1080/2	60Hz	-ve	-ve	742500	Interl
43	1920	1080	24Hz	-ve	-ve	742500	Prog
44	1920	1080	25Hz	-ve	-ve	742500	Prog
45	1920	1080	30Hz	-ve	-ve	742500	Prog
46	1920	1080	50Hz	-ve	-ve	1485000	Prog
47	1920	1080	60Hz	-ve	-ve	1485000	Prog
-- CEA-861-D Timing --							
48	1280	720	24Hz	+ve	+ve	594000	Prog
49	1280	720	25Hz	+ve	+ve	742500	Prog
50	1280	720	30Hz	+ve	+ve	742500	Prog
51	720*2	240	60Hz	-ve	-ve	310260	Interl
52	720*2	240	60Hz	-ve	-ve	310260 (D)	Interl
53	720*2	240	60Hz	-ve	-ve	310260	Prog
54	720*2	240	60Hz	-ve	-ve	310260 (D)	Prog
55	720*4	240	60Hz	-ve	-ve	620520	Interl
56	720*4	240	60Hz	-ve	-ve	620520 (D)	Interl
57	720*4	240	60Hz	-ve	-ve	620520	Prog
58	720*4	240	60Hz	-ve	-ve	620520 (D)	Prog

59	720*2	288	50Hz	-ve	-ve	270000	Interl
60	720*2	288	50Hz	-ve	-ve	270000 (D)	Interl
61	720*2	288	50Hz	-ve	-ve	270000	Prog
62	720*2	288	50Hz	-ve	-ve	270000 (D)	Prog
63	720*4	288	50Hz	-ve	-ve	540000	Interl
64	720*4	288	50Hz	-ve	-ve	540000 (D)	Interl
65	720*4	288	50Hz	-ve	-ve	540000	Prog
66	720*4	288	50Hz	-ve	-ve	540000 (D)	Prog
67	720*2	576	50Hz	-ve	-ve	540000	Prog
68	720*2	576	50Hz	-ve	-ve	540000 (D)	Prog
69	1920	1080	30Hz	+ve	+ve	742500	Prog
70	720*4	480	60Hz	-ve	-ve	1081080	Prog
71	720*4	480	60Hz	-ve	-ve	1081080 (D)	Prog
72	720*4	576	50Hz	-ve	-ve	1081080	Prog
73	720*4	576	50Hz	-ve	-ve	1081080 (D)	Prog
74	1920	540	50Hz	+ve	-ve	720000	Interl
-- CEA-861-D Timing with very high refresh rate --							
75	1920	540	100Hz	+ve	+ve	1485000	Interl
76	1280	720	100Hz	+ve	+ve	1485000	Prog
77	720	576	100Hz	-ve	-ve	540000	Prog
78	720	576	100Hz	-ve	-ve	540000 (D)	Prog
79	720	288	100Hz	-ve	-ve	270000	Interl
80	720	288	100Hz	-ve	-ve	270000 (D)	Interl
81	1920	540	120Hz	+ve	+ve	1485000	Interl
82	1280	720	120Hz	+ve	+ve	1485000	Prog
83	720	480	120Hz	-ve	-ve	540540	Prog
84	720	480	120Hz	-ve	-ve	540540 (D)	Prog
85	720	240	120Hz	-ve	-ve	270270	Interl
86	720	240	120Hz	-ve	-ve	270270 (D)	Interl
87	720	576	200Hz	-ve	-ve	1080000	Prog
88	720	576	200Hz	-ve	-ve	1080000 (D)	Prog
89	720	288	200Hz	-ve	-ve	540000	Interl
90	720	288	200Hz	-ve	-ve	540000 (D)	Interl
91	720	480	240Hz	-ve	-ve	1081080	Prog
92	720	480	240Hz	-ve	-ve	1081080 (D)	Prog
93	720	240	240Hz	-ve	-ve	540540	Interl
94	720	240	240Hz	-ve	-ve	540540 (D)	Interl
-- Frame packing 3D timings --							
95	1280	1470	60Hz	+ve	+ve	1485000	Prog
96	1280	1470	50Hz	+ve	+ve	1485000	Prog
97	1280	1470	24Hz	-ve	-ve	594000	Prog
98	1280	1470	30Hz	-ve	-ve	1485000	Prog
99	1920	2205	24Hz	+ve	+ve	1485000	Prog
100	1920	2205	30Hz	+ve	+ve	1485000	Prog
101	1920	2205	50Hz	+ve	+ve	2970000	Prog
102	1920	2205	60Hz	+ve	+ve	2970000	Prog
-- 4K (2160p) Timings --							
103	3840	2160	24Hz	+ve	+ve	2970000	Prog
104	3840/2	2160	50Hz	+ve	+ve	2970000	Prog
105	3840	2160	25Hz	+ve	+ve	2970000	Prog
106	3840/2	2160	60Hz	+ve	+ve	2970000	Prog
107	3840	2160	30Hz	+ve	+ve	2970000	Prog
-- 4K SMPTE Timings --							
108	4096	2160	24Hz	+ve	+ve	2970000	Prog
109	4096/2	2160	50Hz	+ve	+ve	2970000	Prog
110	4096	2160	25Hz	+ve	+ve	2970000	Prog
111	4096/2	2160	60Hz	+ve	+ve	2970000	Prog
112	4096	2160	30Hz	+ve	+ve	2970000	Prog
113	2560	1080	24Hz	+ve	+ve	990000	Prog
114	2560	1080	25Hz	+ve	+ve	900000	Prog
115	2560	1080	30Hz	+ve	+ve	1188000	Prog
116	2560	1080	50Hz	+ve	+ve	1856250	Prog
117	2560	1080	60Hz	+ve	+ve	1980000	Prog
-- VESA Digital Timing --							
16384	640	350	85Hz	+ve	-ve	315000	Prog

## VERSA-4K

16385	640	400	85Hz	-ve	+ve	315000	Prog
16386	720	400	85Hz	-ve	+ve	355000	Prog
16387	640	480	60Hz	-ve	-ve	251750	Prog
16388	640	480	72Hz	-ve	-ve	315000	Prog
16389	640	480	75Hz	-ve	-ve	315000	Prog
16390	640	480	85Hz	-ve	-ve	360000	Prog
16391	800	600	56Hz	+ve	+ve	360000	Prog
16392	800	600	60Hz	+ve	+ve	400000	Prog
16393	800	600	72Hz	+ve	+ve	500000	Prog
16394	800	600	75Hz	+ve	+ve	495000	Prog
16395	800	600	85Hz	+ve	+ve	562500	Prog
16396	848	480	60Hz	+ve	+ve	337500	Prog
16397	1024	384	87Hz	+ve	+ve	449000	Interl
16398	1024	768	60Hz	-ve	-ve	650000	Prog
16399	1024	768	70Hz	-ve	-ve	750000	Prog
16400	1024	768	75Hz	+ve	+ve	787500	Prog
16401	1024	768	85Hz	+ve	+ve	945000	Prog
16402	1152	864	75Hz	+ve	+ve	1080000	Prog
16403	1280	768	60Hz	+ve	-ve	682500	Prog
16404	1280	768	60Hz	-ve	+ve	795000	Prog
16405	1280	768	75Hz	-ve	+ve	1022500	Prog
16406	1280	768	85Hz	-ve	+ve	1175000	Prog
16407	1280	960	60Hz	+ve	+ve	1080000	Prog
16408	1280	960	85Hz	+ve	+ve	1485000	Prog
16409	1280	1024	60Hz	+ve	+ve	1080000	Prog
16410	1280	1024	75Hz	+ve	+ve	1350000	Prog
16411	1280	1024	85Hz	+ve	+ve	1575000	Prog
16412	1360	768	60Hz	+ve	+ve	855000	Prog
16413	1400	1050	60Hz	+ve	-ve	1010000	Prog
16414	1400	1050	60Hz	-ve	+ve	1217500	Prog
16415	1400	1050	75Hz	-ve	+ve	1560000	Prog
16416	1400	1050	85Hz	-ve	+ve	1795000	Prog
16417	1440	900	60Hz	+ve	-ve	887500	Prog
16418	1440	900	60Hz	-ve	+ve	1065000	Prog
16419	1440	900	75Hz	-ve	+ve	1367500	Prog
16420	1440	900	85Hz	-ve	+ve	1570000	Prog
16421	1600	1200	60Hz	+ve	+ve	1620000	Prog
16422	1600	1200	65Hz	+ve	+ve	1755000	Prog
16423	1600	1200	70Hz	+ve	+ve	1890000	Prog
16424	1600	1200	75Hz	+ve	+ve	2025000	Prog
16425	1600	1200	85Hz	+ve	+ve	2295000	Prog
16426	1680	1050	60Hz	+ve	-ve	1190000	Prog
16427	1680	1050	60Hz	-ve	+ve	1462500	Prog
16428	1680	1050	75Hz	-ve	+ve	1870000	Prog
16429	1680	1050	85Hz	-ve	+ve	2147500	Prog
16430	1792	1344	60Hz	-ve	+ve	2047500	Prog
16431	1792	1344	75Hz	-ve	+ve	2610000	Prog
16432	1856	1392	60Hz	-ve	+ve	2182500	Prog
16433	1856	1392	75Hz	-ve	+ve	2880000	Prog
16434	1920	1200	60Hz	+ve	-ve	1540000	Prog
16435	1920	1200	60Hz	-ve	+ve	1932500	Prog
16436	1920	1200	75Hz	-ve	+ve	2452500	Prog
16437	1920	1200	75Hz	-ve	+ve	2812500	Prog
16438	1920	1440	60Hz	-ve	+ve	2340000	Prog
16439	1920	1440	75Hz	-ve	+ve	2970000	Prog
16440	2560	1600	60Hz	-ve	+ve	2685000	Prog
-- VESA New Timing --							
16441	800	600	120Hz	+ve	-ve	732500	Prog
16442	1024	384	87Hz	+ve	+ve	449000	Prog
16443	1024	768	120Hz	+ve	-ve	1155000	Prog
16444	1152	864	85Hz	-ve	+ve	1196500	Prog
16445	1152	864	100Hz	-ve	+ve	1434700	Prog
16446	1152	864	60Hz	-ve	+ve	816200	Prog
16447	1280	768	120Hz	+ve	-ve	1402500	Prog
16448	1280	800	60Hz	+ve	-ve	710000	Prog



16449	1280	800	60Hz	-ve	+ve	835000	Prog
16450	1280	800	75Hz	-ve	+ve	1065000	Prog
16451	1280	800	85Hz	-ve	+ve	1225000	Prog
16452	1280	800	120Hz	+ve	-ve	1462500	Prog
16453	1280	960	120Hz	+ve	-ve	1755000	Prog
16454	1280	1024	120Hz	+ve	-ve	1872500	Prog
16455	1360	768	120Hz	+ve	-ve	1482500	Prog
16456	1366	768	60Hz	+ve	+ve	720000	Prog
16457	1366	768	60Hz	+ve	-ve	720000	Prog
16458	1366	768	60Hz	+ve	-ve	855000	Prog
16459	1366	768	60Hz	+ve	+ve	855000	Prog
16460	1400	1050	120Hz	+ve	-ve	2080000	Prog
16461	1440	900	120Hz	+ve	-ve	1827500	Prog
16462	1600	900	60Hz	+ve	-ve	1080000	Prog
16463	1600	1200	120Hz	+ve	-ve	2682500	Prog
16464	1680	1050	120Hz	+ve	-ve	2455000	Prog
16465	1920	1080	60Hz	+ve	+ve	1485000	Prog
16466	2048	1152	60Hz	+ve	+ve	1620000	Prog
-- VESA CVT Timing --							
16468	640	480	50Hz	-ve	+ve	197500	Prog
16469	640	480	60Hz	-ve	+ve	237500	Prog
16470	640	480	75Hz	-ve	+ve	307500	Prog
16471	640	480	85Hz	-ve	+ve	350000	Prog
16472	640	480	60Hz	+ve	-ve	235000	Prog
16473	800	600	50Hz	-ve	+ve	307500	Prog
16474	800	600	60Hz	-ve	+ve	382500	Prog
16475	800	600	75Hz	-ve	+ve	490000	Prog
16476	800	600	85Hz	-ve	+ve	567500	Prog
16477	800	600	60Hz	+ve	-ve	355000	Prog
16478	1024	768	50Hz	-ve	+ve	520000	Prog
16479	1024	768	60Hz	-ve	+ve	635000	Prog
16480	1024	768	75Hz	-ve	+ve	820000	Prog
16481	1024	768	85Hz	-ve	+ve	945000	Prog
16482	1024	768	60Hz	+ve	-ve	560000	Prog
16483	1280	960	50Hz	-ve	+ve	830000	Prog
16484	1280	960	60Hz	-ve	+ve	1012500	Prog
16485	1280	960	75Hz	-ve	+ve	1300000	Prog
16486	1280	960	85Hz	-ve	+ve	1482500	Prog
16487	1280	960	60Hz	+ve	-ve	852500	Prog
16488	1400	1050	50Hz	-ve	+ve	1000000	Prog
16489	1400	1050	60Hz	+ve	-ve	1010000	Prog
16490	1600	1200	50Hz	-ve	+ve	1315000	Prog
16491	1600	1200	60Hz	-ve	+ve	1610000	Prog
16492	1600	1200	75Hz	-ve	+ve	2047500	Prog
16493	1600	1200	85Hz	-ve	+ve	2350000	Prog
16494	1600	1200	60Hz	+ve	-ve	1302500	Prog
16495	1920	1440	50Hz	-ve	+ve	1922500	Prog
16496	1920	1440	60Hz	-ve	+ve	2335000	Prog
16497	1920	1440	75Hz	-ve	+ve	2980000	Prog
16498	1920	1440	60Hz	+ve	-ve	1847500	Prog
16499	2048	1536	50Hz	-ve	+ve	2190000	Prog
16500	2048	1536	60Hz	-ve	+ve	2672000	Prog
16501	2048	1536	60Hz	+ve	-ve	2092500	Prog
16502	1280	1024	50Hz	-ve	+ve	885000	Prog
16503	1280	1024	60Hz	-ve	+ve	1090000	Prog
16504	1280	1024	75Hz	-ve	+ve	1387500	Prog
16505	1280	1024	85Hz	-ve	+ve	1595000	Prog
16506	1280	1024	60Hz	+ve	-ve	910000	Prog
16507	1280	768	50Hz	-ve	+ve	652500	Prog
16508	1280	768	60Hz	+ve	-ve	682500	Prog
16509	848	480	50Hz	-ve	+ve	260000	Prog
16510	848	480	60Hz	-ve	+ve	315000	Prog
16511	848	480	75Hz	-ve	+ve	410000	Prog
16512	848	480	85Hz	-ve	+ve	467500	Prog
16513	848	480	60Hz	+ve	-ve	297500	Prog

## VERSA-4K

16514	1064	600	50Hz	-ve	+ve	407500	Prog
16515	1064	600	60Hz	-ve	+ve	505000	Prog
16516	1064	600	75Hz	-ve	+ve	652500	Prog
16517	1064	600	85Hz	-ve	+ve	752500	Prog
16518	1064	600	60Hz	+ve	-ve	452500	Prog
16519	1280	720	50Hz	-ve	+ve	605000	Prog
16520	1280	720	60Hz	-ve	+ve	745000	Prog
16521	1280	720	75Hz	-ve	+ve	957500	Prog
16522	1280	720	85Hz	-ve	+ve	1102500	Prog
16523	1280	720	60Hz	+ve	-ve	640000	Prog
16524	1360	768	50Hz	-ve	+ve	690000	Prog
16525	1360	768	60Hz	-ve	+ve	847500	Prog
16526	1360	768	75Hz	-ve	+ve	1090000	Prog
16527	1360	768	85Hz	-ve	+ve	1252500	Prog
16528	1360	768	60Hz	+ve	-ve	720000	Prog
16529	1704	960	50Hz	-ve	+ve	1105000	Prog
16530	1704	960	60Hz	-ve	+ve	1352500	Prog
16531	1704	960	75Hz	-ve	+ve	1727500	Prog
16532	1704	960	85Hz	-ve	+ve	1985000	Prog
16533	1704	960	60Hz	+ve	-ve	1102500	Prog
16534	1864	1050	50Hz	-ve	+ve	1327500	Prog
16535	1864	1050	60Hz	-ve	+ve	1625000	Prog
16536	1864	1050	75Hz	-ve	+ve	2075000	Prog
16537	1864	1050	85Hz	-ve	+ve	2380000	Prog
16538	1864	1050	60Hz	+ve	-ve	1310000	Prog
16539	1920	1080	50Hz	-ve	+ve	1415000	Prog
16540	1920	1080	60Hz	-ve	+ve	1730000	Prog
16541	1920	1080	75Hz	-ve	+ve	2207500	Prog
16542	1920	1080	85Hz	-ve	+ve	2532000	Prog
16543	1920	1080	60Hz	+ve	-ve	1385000	Prog
16544	2128	1200	50Hz	-ve	+ve	1750000	Prog
16545	2128	1200	60Hz	-ve	+ve	2137500	Prog
16546	2128	1200	75Hz	-ve	+ve	2725000	Prog
16547	2128	1200	60Hz	+ve	-ve	1695000	Prog
16548	2560	1440	50Hz	-ve	+ve	2562000	Prog
16550	2728	1536	50Hz	-ve	+ve	2917000	Prog
16551	2728	1536	60Hz	+ve	-ve	2737000	Prog
16552	768	480	50Hz	-ve	+ve	237500	Prog
16553	768	480	60Hz	-ve	+ve	287500	Prog
16554	768	480	75Hz	-ve	+ve	367500	Prog
16555	768	480	85Hz	-ve	+ve	425000	Prog
16556	768	480	60Hz	+ve	-ve	275000	Prog
16557	960	600	50Hz	-ve	+ve	370000	Prog
16558	960	600	60Hz	-ve	+ve	452500	Prog
16559	960	600	75Hz	-ve	+ve	587500	Prog
16560	960	600	85Hz	-ve	+ve	677500	Prog
16561	960	600	60Hz	+ve	-ve	415000	Prog
16562	1152	720	50Hz	-ve	+ve	545000	Prog
16563	1152	720	60Hz	-ve	+ve	667500	Prog
16564	1152	720	75Hz	-ve	+ve	857500	Prog
16565	1152	720	85Hz	-ve	+ve	990000	Prog
16566	1152	720	60Hz	+ve	-ve	582500	Prog
16567	1224	768	50Hz	-ve	+ve	622500	Prog
16568	1224	768	60Hz	-ve	+ve	760000	Prog
16569	1224	768	75Hz	-ve	+ve	977500	Prog
16570	1224	768	85Hz	-ve	+ve	1125000	Prog
16571	1224	768	60Hz	+ve	-ve	655000	Prog
16572	1536	960	50Hz	-ve	+ve	997500	Prog
16573	1536	960	60Hz	-ve	+ve	1212500	Prog
16574	1536	960	75Hz	-ve	+ve	1552500	Prog
16575	1536	960	85Hz	-ve	+ve	1785000	Prog
16576	1536	960	60Hz	+ve	-ve	1005000	Prog
16577	1680	1050	50Hz	-ve	+ve	1195000	Prog
16578	1680	1050	60Hz	+ve	-ve	1190000	Prog
16579	1728	1080	50Hz	-ve	+ve	1272500	Prog

16580	1728	1080	60Hz	-ve	+ve	1557500	Prog
16581	1728	1080	75Hz	-ve	+ve	1977500	Prog
16582	1728	1080	85Hz	-ve	+ve	2270000	Prog
16583	1728	1080	60Hz	+ve	-ve	1257500	Prog
16584	1920	1200	50Hz	-ve	+ve	1582500	Prog
16585	1920	1200	85Hz	-ve	+ve	2812000	Prog
16586	1920	1200	60Hz	+ve	-ve	1540000	Prog
16587	2304	1440	50Hz	-ve	+ve	2302500	Prog
16588	2304	1440	60Hz	-ve	+ve	2807000	Prog
16589	2304	1440	60Hz	+ve	-ve	2187500	Prog
16590	2456	1536	50Hz	-ve	+ve	625000	Prog
16591	2456	1536	60Hz	+ve	-ve	2477500	Prog
-- PC Timing --							
16592	640	350	70Hz	+ve	-ve	251750	Prog
16593	720	400	70Hz	-ve	+ve	283200	Prog
16594	1024	384	87Hz	+ve	+ve	449000	Prog
16595	640	480	67Hz	-ve	-ve	302400	Prog
16596	834	624	75Hz	-ve	-ve	572800	Prog
16597	1024	768	60Hz	-ve	-ve	639900	Prog
16598	1024	768	75Hz	-ve	-ve	800000	Prog
16599	1152	870	75Hz	-ve	-ve	1000000	Prog
-- SPWG Panel Timing --							
16600	1024	768	60Hz	-ve	-ve	560000	Prog
16601	1400	1050	60Hz	-ve	-ve	1010000	Prog
16602	1600	1200	60Hz	-ve	-ve	1301990	Prog
16603	1280	800	60Hz	-ve	-ve	710000	Prog
16604	1440	900	60Hz	-ve	-ve	887500	Prog
16605	1680	1050	60Hz	-ve	-ve	1190000	Prog
16606	1920	1200	60Hz	-ve	-ve	1540000	Prog
16607	2048	1536	60Hz	-ve	-ve	2092000	Prog
-- GTF --							
16608	1024	768	75Hz	+ve	-ve	810079	Prog
16609	1280	800	75Hz	+ve	-ve	1070020	Prog
16610	852	480	60Hz	-ve	-ve	340252	Prog
16611	1400	788	60Hz	+ve	-ve	757500	Prog
16612	1280	1024	96Hz	+ve	+ve	1258291	Prog
16613	1365	1024	60Hz	+ve	+ve	1200000	Prog
16614	1365	1024	75Hz	+ve	+ve	1440000	Prog
16615	1440	960	72Hz	-ve	-ve	1290240	Prog
16616	1920	1440	60Hz	-ve	+ve	2340000	Prog
16617	1920	1440	75Hz	-ve	+ve	2970000	Prog
16618	2048	1280	60Hz	-ve	-ve	2213280	Prog
16619	832	624	75Hz	-ve	-ve	549360	Prog
16620	1024	576	60Hz	+ve	+ve	472032	Prog
16621	1365	1024	60Hz	-ve	-ve	1165152	Prog
16622	1400	788	60Hz	-ve	-ve	918000	Prog
16623	1600	1024	60Hz	-ve	-ve	1363580	Prog
-- 2560x1200 VESA CVT Generated Timing --							
16624	2560	1200	30Hz	-ve	+ve	1197500	Prog
16625	2560	1200	60Hz	-ve	+ve	2577500	Prog
16626	2560	1200	60Hz	+ve	-ve	2015000	Prog

**HDMI Audio Format Support List**

<b>Dolby</b>	<b>DTS</b>	<b>Linear PCM</b>
Dolby Digital 5.1 ch	DTS 5.1 ch	Linear PCM 2 ch 44.1 kHz
Dolby Digital Plus	DTS 96/24	Linear PCM 2 ch 88.2 kHz
Dolby Digital Pro-Logic	DTS-ES Discrete	Linear PCM 2 ch 176.4 kHz
Dolby TrueHD	DTS-ES Matrix	Linear PCM 2 ch 32 kHz
Dolby Atmos	DTS-HD High Resolution Audio	Linear PCM 2 ch 48 kHz
	DTS-HD Master Audio	Linear PCM 2 ch 96 kHz
	DTS:X	Linear PCM 2 ch 192 kHz
		Linear PCM 5.1 ch 44.1 kHz
		Linear PCM 5.1 ch 88.2 kHz
		Linear PCM 5.1 ch 176.4 kHz
		Linear PCM 5.1 ch 32 kHz
		Linear PCM 5.1 ch 48 kHz
		Linear PCM 5.1 ch 96 kHz
		Linear PCM 5.1 ch 192 kHz
		Linear PCM 6.1 ch 44.1 kHz
		Linear PCM 6.1 ch 88.2 kHz
		Linear PCM 6.1 ch 176.4 kHz
		Linear PCM 6.1 ch 32 kHz
		Linear PCM 6.1 ch 48 kHz
		Linear PCM 6.1 ch 96 kHz
		Linear PCM 6.1 ch 192 kHz
		Linear PCM 7.1 ch 44.1 kHz
		Linear PCM 7.1 ch 88.2 kHz
		Linear PCM 7.1 ch 176.4 kHz
		Linear PCM 7.1 ch 32 kHz
		Linear PCM 7.1 ch 48 kHz
		Linear PCM 7.1 ch 96 kHz
		Linear PCM 7.1 ch 192 kHz

**USB 2.0 Supported Class List**

Audio	Personal Healthcare
Communications and CDC Control	Audio/Video Devices
HID (Human Interface Device)	Diagnostic Device
Physical	Wireless Controller
Image	Miscellaneous
Printer	Application Specific
Mass Storage	Vendor Specific
CDC Data	
Smart Card	
Content Security	
Video (Video Streaming not supported)	

**RS-232 Supported Baud rate List**

300, 600, 1200, 2400, 4800, 9600, 19200, 38400, 57600, 115200
---



© Copyright 2018. Hall Research, Inc.  
All rights reserved.

1163 Warner Ave., Tustin, CA 92780  
Ph: (714)641-6607