

HES[®] 1600 Electric Strike

Works with all brands of cylindrical and mortise locksets, with or without a deadbolt



Also available in a Complete One Box Solution

The HES 1600 Series electric strike accommodates up to a 1" deadbolt with enhanced vertical cavity spacing.

The HES 1600 Series Electric Strike sets a new standard in the industry by offering dynamic integrated adjustability and field configurable options compatible with any cylindrical or mortise lock. The modular design of the platform makes stocking and installing easier with interchangeable faceplates and accessories. For the first time, the aesthetics of an electric strike are complementary to other surrounding door hardware and blend in with the opening due to the fully finished design, available in eight finishes.

Features

Standard Features

- Stainless steel construction
- Tamper resistant
- Static strength 1,500 lbs
- Dynamic strength 70 ft-lbs
- Endurance 1 million cycles
- Field selectable fail safe/fail secure
- Non-handed
- Interchangeable faceplates and accessories
- Field replaceable components
- Fully finished faceplate, keeper, case and trim
- Field adjustable integrated shim
- Strike body depth 1-5/8" [41.3mm]
- SecuriCare ten-year, no-fault, no questions asked warranty

Optional Features

- **LM** Lock monitor
- **DLM** Dual lock monitors
- **LMS** Lock monitor and strike monitor
- **DLMS** Dual lock monitors and strike monitor

Accessories

- **157** Torx screws
- **HES-CUT-MTK** Metal template kit
- **1600-104-xxx** Lip extension trim adapter (finish to match)
- **1600-106-xxx** 1006 adapter and trim enhancer kit (finish to match)
- **OPT-1SRK** Spring replacement kit
- **OPT-1LM** Single lock monitor
- **OPT-1DLM** Dual lock monitors
- **MOD-1SOL** Solenoid replacement module

For easy 3D instructions, download the BILT mobile app



Grade 1



SecuriCare
Warranty



Mortise Locks
with Deadbolt



Mortise Locks
without
Deadbolt



Cylindrical
Locksets



Field Selectable
(Fail secure
/Fail safe)



Dual Voltage
12/24



PoE
Friendly



Fire Rated



Windstorm
Resistant



Outdoor
Rated



Burglary
Rated

Specifications

Certifications

- ANSI/BHMA A156.31, Grade 1
- UL 1034 burglary-resistant listed and suitable for outdoor use
- UL 294 listed
- RoHS compliant
- UL 10C fire rated, 3-hour single door (fail secure only)
- UL 10C fire rated, 1-1/2 hour double door (fail secure only)
- CAN/ULC-S104 fire door conformant
- NFPA-252 fire door compliant
- ASTM-E152 fire door compliant
- California Fire Marshal listed
- ANSI/SDI A250.13 windstorm resistant
- Florida Building Code approved TAS 201, 202, 203
- ANSI-ASTM E330

Frame Application

- Metal
- Wood

Electrical (DC Continuous Duty)

- Dual voltage 12/24 VDC/VAC
- 240 mA at 12 VDC/120 mA at 24 VDC
- PoE friendly

Dimensions

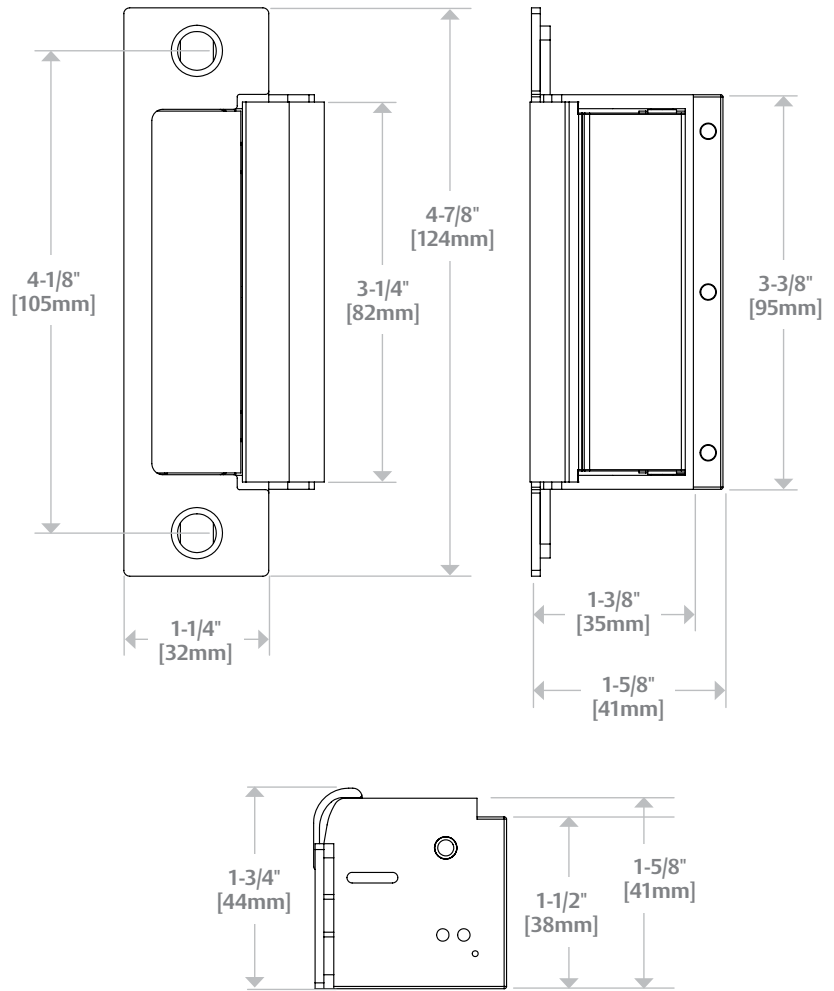

How to Order

SERIES	MODEL	FINISH*	OPTION (S)
1600	- CS	- 630	- LM
1600 Universal Electric Strike; Faceplate option kits ordered separately	CS* Complete Electric Strike; includes 1LB faceplate kit for latchbolts and 1DB faceplate kit for deadbolts	605 Bright Brass 606 Satin Brass 612 Satin Bronze 613 Bronze Toned	LM Lock Monitor DLM Dual Lock Monitor LMS Lock Monitor and Strike Monitor
	CLB* Complete Electric Strike for Latchbolt Locks; includes 1LB faceplate kit for latchbolts	613E Dark Oxidized Satin Bronze Powder 629 Bright Stainless Steel	DLMS Dual Lock Monitors and Strike Monitor
	CDB* Complete Electric Strike for Deadbolt Locks; includes 1DB faceplate kit for deadbolts	630 Satin Stainless Steel BSP Black Suede Powder	OPT-1LM Single Lock Monitor OPT-1DLM Dual Lock Monitors

*Complete Pacs are only available in the 630 finish

NOTE: Electric strike compatibility is determined at time of electric strike product release. ASSA ABLOY is not responsible for incompatibility of products that have changed in design or craftsmanship by their respective manufacturers. When compatibility is a concern, contact Customer Support for application assistance.

HES 1500C Complete Electric Strike

For all cylindrical and mortise locksets with 3/4" latchbolt.

The HES 1500C includes a HES 1500 electric strike body and the 1LB faceplate kit for latchbolts.

1J Option 1KM Option

1K Option 1KD Option

Compatible Locksets

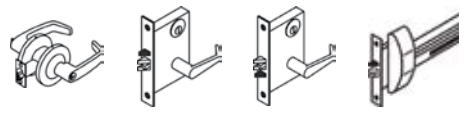

HES 1600CLB Complete for Latchbolt Locks

The Complete One Box Solution for all cylindrical and mortise locksets.

The HES 1600CLB includes a HES 1600 electric strike body and the 1LB faceplate kit for latchbolts.

1J Option 1KM Option

1K Option 1KD Option

Compatible Locksets

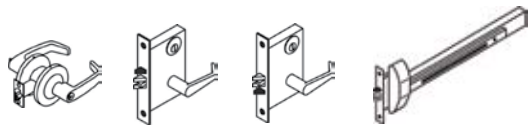

HES 1600CS Complete Electric Strike

The Complete One Box Solution for all cylindrical and mortise locksets, with or without a 1" deadbolt.

The HES 1600CS includes a HES 1600 electric strike body, the 1LB faceplate kit for latchbolts and the 1DB faceplate kit for deadbolts.

1J Option 1KD Option 1ND Option

1K Option 1N Option 1NTD Option

1KM Option 1NM Option

Compatible Locksets

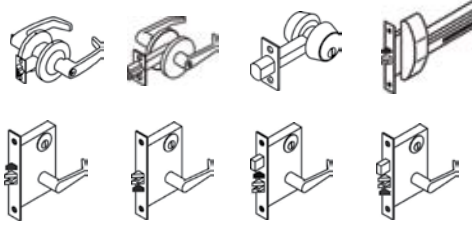

HES 1600CDB Complete for Deadbolt Locks

The Complete One Box Solution for all locksets with a 1" deadbolt.

The HES 1600CDB includes a HES 1600 electric strike body and the 1DB faceplate kit for deadbolts.







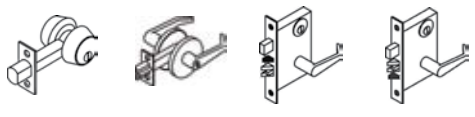

1N Option 1ND Option

1NM Option 1NTD Option

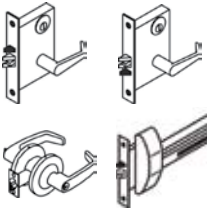
Compatible Locksets

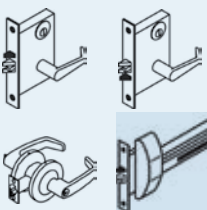

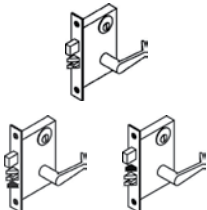
HES 1500 & 1600 Series Faceplate Options

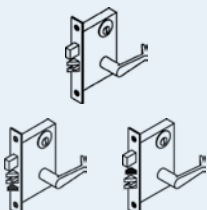
<p>OPERATION</p>	 <p>Cylindrical Locksets Mortise Locks without Deadbolt</p>	<p>After releasing the latchbolt, the keeper returns to the locked position.</p>
 <p>4-7/8" × 1-1/4" [123.8mm x 31.75mm]</p>	<p>1LB Option</p> <p>The Latchbolt Solution: Includes the hardware to accommodate every cylindrical and mortise lock up to a 3/4" [19mm] latchbolt. For metal frame applications.</p>	
<p>OPERATION</p>	 <p>Cylindrical Locksets Mortise Locks without Deadbolt</p>	<p>After releasing the latchbolt, the keeper returns to the locked position.</p>
 <p>9" × 1-3/8" [123.8mm x 34.9mm]</p>	<p>1LB-2 Option</p> <p>The Latchbolt Solution: Includes the hardware to accommodate every cylindrical and mortise lock up to a 3/4" [19mm] latchbolt. For wood frame applications.</p>	
<p>OPERATION</p>	 <p>Mortise Locks with Deadbolt</p>	<p>After releasing the latchbolt, the keeper returns to the locked position.</p>
 <p>4-7/8" × 1-1/4" [123.8mm x 31.75mm]</p>	<p>1DB Option (HES 1600 Only)</p> <p>The Deadbolt Solution: Includes all hardware to retain, and release all mortise locks, and tubular deadbolts up to a 1" latchbolt. For metal frame applications.</p> <p><i>Mode 1: Night latch function. The deadbolt is retracted during traffic hours. The latchbolt is released by the keeper and keeper returns to the locked position.</i></p> <p><i>Mode 2: Lockout function. The electric strike will not release if the deadbolt is extended.</i></p>	
<p>OPERATION</p>	 <p>Mortise Locks with Deadbolt</p>	<p>After releasing the latchbolt, the keeper returns to the locked position.</p>
 <p>9" × 1-3/8" [123.8mm x 34.9mm]</p>	<p>1DB-2 Option (HES 1600 Only)</p> <p>The Deadbolt Solution: Includes all hardware to retain, and release all mortise locks, and tubular deadbolts up to a 1" latchbolt. For wood frame applications.</p> <p><i>Mode 1: Night latch function. The deadbolt is retracted during traffic hours. The latchbolt is released by the keeper and keeper returns to the locked position.</i></p> <p><i>Mode 2: Lockout function. The electric strike will not release if the deadbolt is extended.</i></p>	

HES 1500 & 1600 Series Faceplate Option Dimensions

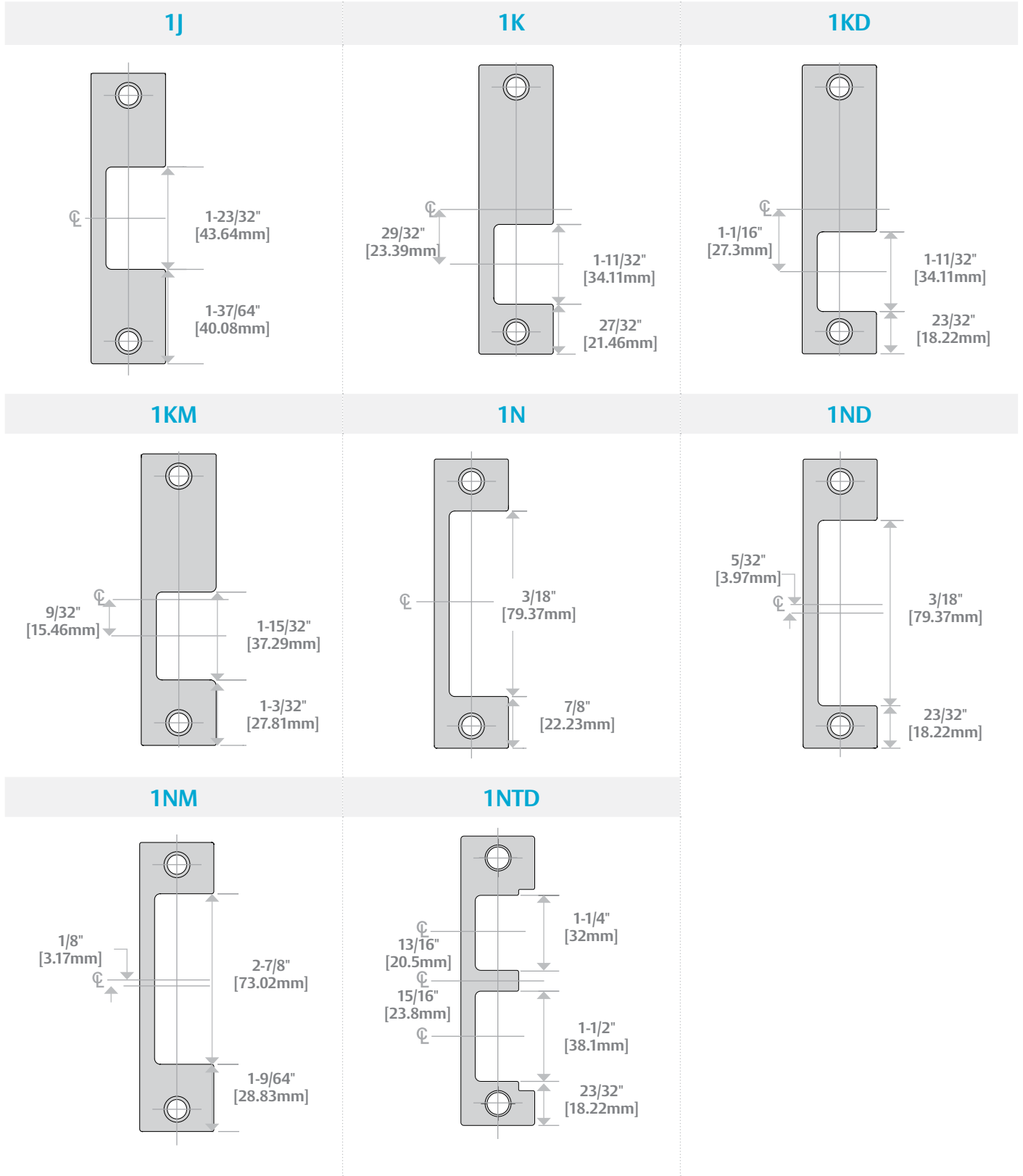

HES 1500 & 1600 Series Faceplate Option Dimensions

