



*Central
Vacuum*
Valves, Fittings
& Accessories

Vaculine[®]

Product Catalog

www.vaculine.com

canplas[®]
an *O*Aliaxis company



canplas®

With more than 40 years experience, Canplas remains focused on meeting the needs of our customers.

With our extensive offering of central vacuum products, Canplas has established itself as a premier manufacturer of quality products for the construction and floor care industries.

As Canplas continues to evolve and adapt to the changing needs of our customers, our foundation remains unchanged and reflects our fundamental commitment to customer service, high quality and innovation.

	PAGE		PAGE
1.0 VALVES		4.0 GUARDS & PLATES	
1.1 VACUSWEEP	4	4.1 PLASTER GUARDS	16
1.2 INLET VALVES	4	4.2 ROUGH-IN COVER PLATES	16
1.3 ES SQUARE VALVES	7		
1.4 CYCLONIC & UTILITY VALVES	8	5.0 HOSES	
		5.1 HOSES	17
2.0 FITTINGS		6.0 INSTALLATION KITS	
2.1 BASIC SEVEN FITTINGS	9	6.1 INSTALLATION KITS	18
2.2 SPECIALTY FITTINGS	9		
2.3 WYES & TEES	12	7.0 WARRANTY	19
2.4 FLANGED FITTINGS	12		
2.5 PIPE ACCESSORIES	13		
2.6 REDUCERS & ADAPTERS	13		
2.7 MUFFLERS & EXHAUST VENT	14		
3.0 MOUNTING PLATES			
3.1 MOUNTING PLATES	15		

STANDARDS, QUALITY & CODES

STANDARDS

Vaculine® fittings are manufactured in compliance with ASTM F2158, Standard Specification for Residential Central Vacuum Tube and Fittings.

The scope of this standard includes material and performance requirements for tube and fittings used in central vacuum systems. It also offers a recommended installation practice that provides step by step instructions, including a “how to” plan to install a central vacuum system and a list of tools to complete the installation.

Compliance with the standard is confirmed when either the tube or fitting is marked with ASTM F2158 and the mark of a recognized Third Party Testing Organization. The Manufacturer is then declaring that the product was manufactured, inspected, tested and listed in accordance with the Standard Relevant Building Codes.

QUALITY

Canplas Industries Ltd, is an ISO 9001: 2000 Company. Certification was originally received December 18, 2000 and currently registered with QMI®, a division of CSA Group.

CODE

The use of any product in the construction/building environment is governed by Construction Codes administered by Local Jurisdiction’s Having Authority (JHA). The Construction Code that includes reference to Central Vacuum Cleaning Systems is the Uniform Mechanical Code (UMC), published by the International Association of Plumbing and Mechanical Officials (IAPMO R&T) which is available at: www.iapmo.org under the Product Listing Directory.

Vaculine® fittings are approved and listed to the IAPMO requirements and can be found under the Canplas Industries Ltd listings. A copy of the central vacuum fitting listing certificate can be viewed and downloaded from the IAPMO R&T website.

Standards and Codes are living documents that change from year to year and can affect the design and use of Central Vacuum Fittings.

1.0 Valves



Valves

1.1 VACUSWEEP

SWEEP INLET VALVE

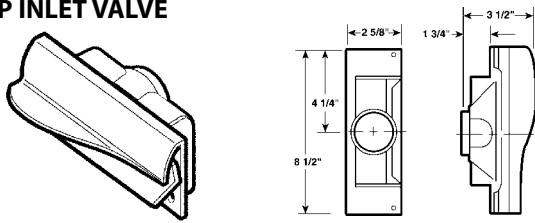

PART #	COLOR.	CTN. QTY.	CTN WT (KGS)	CTN WT (LBS)	CTN CUBIC (M ³)	CTN CUBIC (FT ³)	CTNS / SKID
775600W	White	12	3.84	8.46	0.04	1.35	36
775600	Ivory	12	3.84	8.46	0.04	1.35	36
775600A	Almond	12	3.84	8.46	0.04	1.35	36
775600BLK	Black	12	3.84	8.46	0.04	1.35	36
775600S	Stainless Steel	12	3.84	8.46	0.04	1.35	36

- USE WITH 90° SHORT SOCKET ELBOW (765504W) PERMITS 360° ACCESS AND INSTALLATION IN 2" x 4" STUD WALL.
 - USE WITH PIPE LINK ADAPTER (765526) ALLOWS FLEXIBLE DIRECT ACCESS
 - USE WITH COUPLING (765529W) ALLOWS FOR PIPE ACCESS.
- FITTINGS ARE NOT TO BE GLUED.

TRIM PLATE

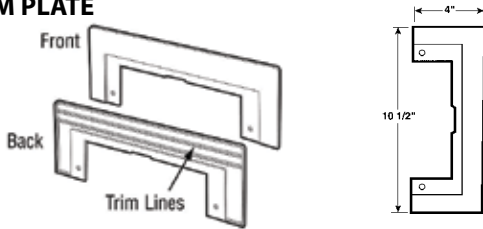

PART #	COLOR.	CTN. QTY.	CTN WT (KGS)	CTN WT (LBS)	CTN CUBIC (M ³)	CTN CUBIC (FT ³)
775601W	White	25	1.23	2.71	0.01	0.20
775601	Ivory	25	1.23	2.71	0.01	0.20
775601A	Almond	25	1.23	2.71	0.01	0.20
775601BLK	Black	25	1.23	2.71	0.01	0.20
775601S	Stainless Steel	25	1.23	2.71	0.01	0.20

ROUGH-IN PLATE

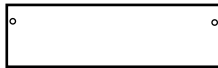

PART #	COLOR.	CTN. QTY.	CTN WT (KGS)	CTN WT (LBS)	CTN CUBIC (M ³)	CTN CUBIC (FT ³)
775602	White	100	1.17	3.56	0.01	0.17

FLEXIBLE HOSE

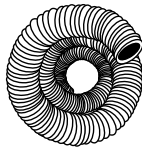

PART #	COLOR.	LENGTH
775700-1	Black	50FT
775700-2	Black	4FT
775700-3	Black	5FT

1.2 INLET VALVES

110/120V ELECTRAVALVE

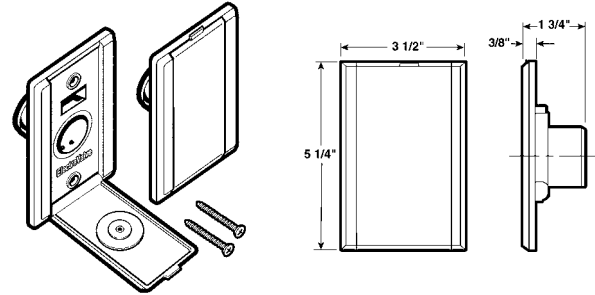

PART #	COLOR.	CTN. QTY.	CTN WT (KGS)	CTN WT (LBS)	CTN CUBIC (M ³)	CTN CUBIC (FT ³)	CTNS / SKID
775595V3W	White	32	3.47	7.64	0.02	0.79	72
775595V3	Ivory	32	3.47	7.64	0.02	0.79	72
775595V3A	Almond	32	3.47	7.64	0.02	0.79	72
775595V3BLK	Black	32	3.47	7.64	0.02	0.79	72

ROUGH-IN KIT 12 AWG & 14 AWG

(INCLUDES: CORD, PLUG, PLASTER GUARD, MOUNTING PLATE & INSTRUCTIONS)

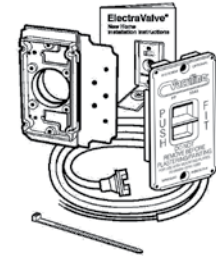

PART #	CORD	CTN. QTY.	CTN WT (KGS)	CTN WT (LBS)	CTN CUBIC (M ³)	CTN CUBIC (FT ³)	CTNS / SKID
3' CORD; 12 GAUGE WIRE							
775594-12-3	Yellow	16	3.73	8.21	0.02	0.79	72
6' CORD; 12 GAUGE WIRE							
775594-12-6	Yellow	16	5.90	12.01	0.02	0.79	72
14' CORD; 12 GAUGE WIRE							
775594-12-14	Yellow	16	8.72	19.23	0.03	1.15	48
3' CORD; 14 GAUGE WIRE							
775594-14-3	White	16	3.35	7.37	0.02	0.79	72
6' CORD; 14 GAUGE WIRE							
775594-14-6	White	16	4.33	9.54	0.02	0.79	72
14' CORD; 14 GAUGE WIRE							
775594-14-14	White	16	7.175	15.82	0.03	1.15	48

RETRO FIT KIT

THE RETROFIT KIT IS PERFECT FOR REPLACING A DAMAGED PLUG.

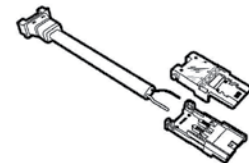

PART #	CTN. QTY.	CTN WT (KGS)	CTN WT (LBS)	CTN CUBIC (M ³)	CTN CUBIC (FT ³)
12 GAUGE WIRE					
775595RKV3	5	0.48	1.05	0.01	0.15
14 GAUGE WIRE					
775595RKV4	5	0.43	0.95	0.01	0.15

DESIGNED FOR EASE OF INSTALLATION



THE IDEAL
DIRECT
CONNECT
VALVE FOR
RETROFITS!

Valves

ELECTRAVALVE®

& ROUGH-IN KITS



Valve and Rough-in kit are sold separately

Step 1 - Order Electravalue in your colour choice

Step 2 - Order Rough in Kit with your wiring choice

The unique design of this patented valve eliminates the need for extra plugs and extension cords to drive a power beater brush.

ElectraValve® is a Recognized Component by Underwriters Laboratories (UL), under File # E150250 and File # E184142. The UL reversed logo is visible on the underside of the ElectraValve® cover after the entire assembly is installed.

ElectraValve® has no exposed non-current carrying metal parts and the conductors are encapsulated in the UL approved two pin plug (see marking on face of plug). NOTE: Ground wire is only required where there are exposed non-current carrying metal parts.

AS EASY AS OPENING A BOOK



REVEALS A NEW
LOOK TO THE
TRADITIONAL
VERTICAL-
OPENING
VALVES

THE NEW

SIDE-OPENING VALVE



VacuValve
Side-Opening



ElectraValve
Side-Opening

PART #	COLOR.	CTN. QTY.	CTN WT (KGS)	CTN WT (LBS)	CTN CUBIC (M ³)	CTN CUBIC (FT ³)	CTNS / SKID
VacuValve Side-Opening Inlet Valve							
775591W	White	24	3.08	6.78	0.01	0.44	80
775591	Ivory	24	3.08	6.78	0.01	0.44	80
775591A	Almond	24	3.08	6.78	0.01	0.44	80
ElectraValve Side-Opening Inlet Valve							
775598W	White	24	3.06	6.73	0.02	0.71	80
775598	Ivory	24	3.06	6.73	0.02	0.71	80
775598A	Almond	24	3.06	6.73	0.02	0.71	80

Valves

1.2 INLET VALVES

VACUVALVE

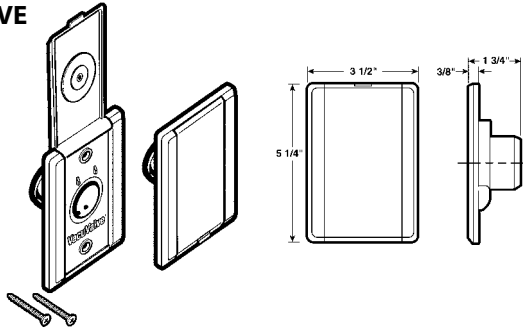

PART #	COLOR.	CTN. QTY.	CTN WT (KGS)	CTN WT (LBS)	CTN CUBIC (M ³)	CTN CUBIC (FT ³)	CTNS / SKID
775590W	White	32	3.50	7.70	0.02	0.79	72
775590	Ivory	32	3.42	7.54	0.02	0.79	72
775590A	Almond	32	3.42	7.54	0.02	0.79	72
775590BLK	Black	32	3.42	7.54	0.02	0.79	72

TRIM PLATE

THE TRIM PLATE MOUNTS BEHIND THE VALVE TO COVER UNSIGHTLY GAPS IN THE DRYWALL AND TO ENHANCE THE DECOR OF THE VALVE.

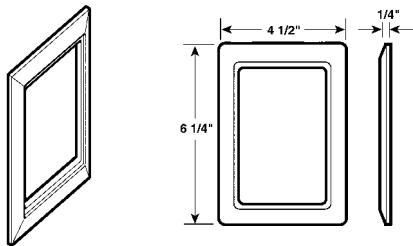

PART #	COLOR.	CTN. QTY.	CTN WT (KGS)	CTN WT (LBS)	CTN CUBIC (M ³)	CTN CUBIC (FT ³)	CTNS / SKID
775589W	White	150	3.71	8.35	0.02	0.79	72
775589	Ivory	150	3.67	8.10	0.02	0.79	72
775589A	Almond	150	3.67	8.30	0.02	0.79	72
775589BLK	Black	150	3.73	8.20	0.02	0.79	72



1.3 ES SQUARE VALVES

ES PLASTIC VALVE

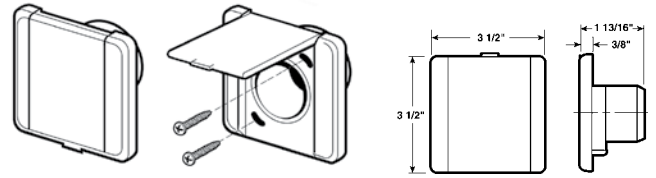

PART #	COLOR.	CTN. QTY.	CTN WT (KGS)	CTN WT (LBS)	CTN CUBIC (M ³)	CTN CUBIC (FT ³)	CTNS / SKID
775592W	White	48	4.07	9.0	0.02	0.79	72
775592	Ivory	48	4.07	8.97	0.02	0.79	72
775592A	Almond	48	4.07	8.95	0.02	0.79	72
775592BLK	Black	48	4.08	8.99	0.02	0.79	72

ES METAL VALVE

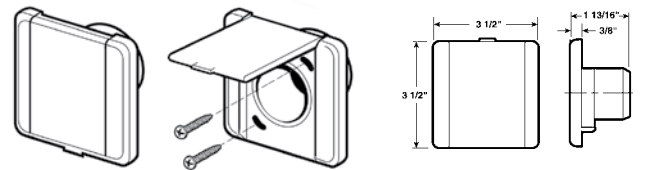

PART #	COLOR.	CTN. QTY.	CTN WT (KGS)	CTN WT (LBS)	CTN CUBIC (M ³)	CTN CUBIC (FT ³)
775892W	White	12	3.83	8.44	0.01	0.32
775892A	Almond	12	3.83	8.44	0.01	0.32
775892OB	Oriental Bronze	12	3.83	8.44	0.01	0.32
775892GM	Gun Metal	12	3.83	8.44	0.01	0.32
775892S	Silver Vein	12	3.83	8.44	0.01	0.32
775892P	Pewter	12	3.83	8.44	0.01	0.32
775892PR	Primer	12	3.83	8.44	0.01	0.32

ES TRIM PLATE

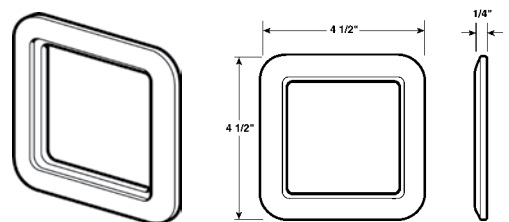

PART #	COLOR.	CTN. QTY.	CTN WT (KGS)	CTN WT (LBS)	CTN CUBIC (M ³)	CTN CUBIC (FT ³)	CTNS / SKID
775588W	White	165	3.10	6.80	0.02	0.79	72
775588	Ivory	165	2.97	6.54	0.02	0.79	72
775588A	Almond	165	2.87	6.31	0.02	0.79	72
775588BLK	Black	165	2.97	6.31	0.02	0.79	72

1.0 Valves



Valves

1.4 CYCLONIC & UTILITY VALVES

UTILITY VALVE

- SPIGOT x VALVE

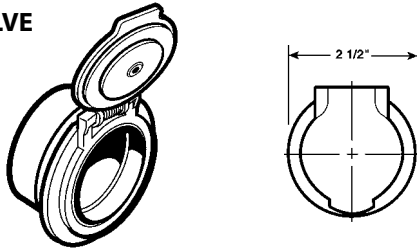

PART #	COLOR.	CTN. QTY.	CTN WT (KGS)	CTN WT (LBS)	CTN CUBIC (M ³)	CTN CUBIC (FT ³)	CTNS / SKID
775583W	White	100	4.58	10.09	0.02	0.79	72
775583	Gray	100	4.58	10.09	0.02	0.79	72

UTILITY VALVE WITH GROMMET

AND RETAINING RING - SPIGOT x VALVE

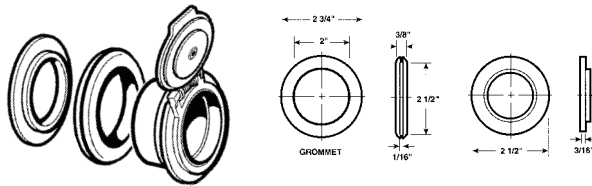

PART #	COLOR.	CTN. QTY.	CTN WT (KGS)	CTN WT (LBS)	CTN CUBIC (M ³)	CTN CUBIC (FT ³)	CTNS / SKID
775584W	White	100	5.11	11.25	0.02	0.79	72
775584	Gray	100	5.11	11.25	0.02	0.79	72
775584BLK	Black	100	4.16	11.25	0.02	0.79	72

UTILITY VALVE WITH PIN JACKS - SPIGOT x VALVE

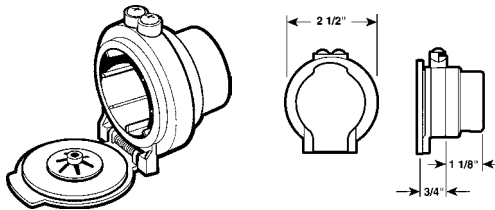

PART #	COLOR.	CTN. QTY.	CTN WT (KGS)	CTN WT (LBS)	CTN CUBIC (M ³)	CTN CUBIC (FT ³)	CTNS / SKID
775586W	White	100	6.21	13.69	0.02	0.79	72
775586	Gray	100	6.21	13.69	0.02	0.79	72
775586BLK	Black	100	4.99	11.0	0.02	0.79	72

CYCLONIC VALVE WITH GASKET-RH ORIENTATION

- FLANGE x VALVE

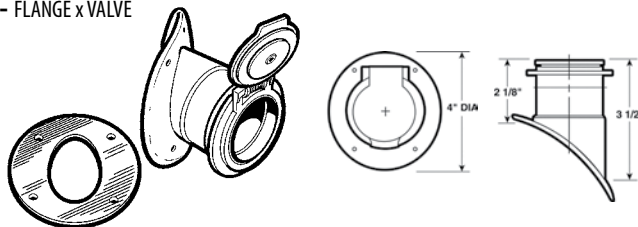

PART #	COLOR.	CTN. QTY.	CTN WT (KGS)	CTN WT (LBS)	CTN CUBIC (M ³)	CTN CUBIC (FT ³)	CTNS / SKID
775585RW	White	50	5.82	12.84	0.03	1.15	48
775585R	Gray	50	5.82	12.84	0.03	1.15	48

1.4 CYCLONIC & UTILITY VALVES

CYCLONIC VALVE WITH GASKET-LH ORIENTATION

- FLANGE x VALVE

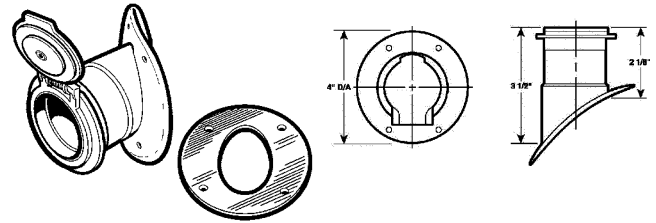

PART #	COLOR.	CTN. QTY.	CTN WT (KGS)	CTN WT (LBS)	CTN CUBIC (M ³)	CTN CUBIC (FT ³)	CTNS / SKID
775585LW	White	50	5.84	12.98	0.03	1.15	48
775585L	Gray	50	5.84	12.98	0.03	1.15	48

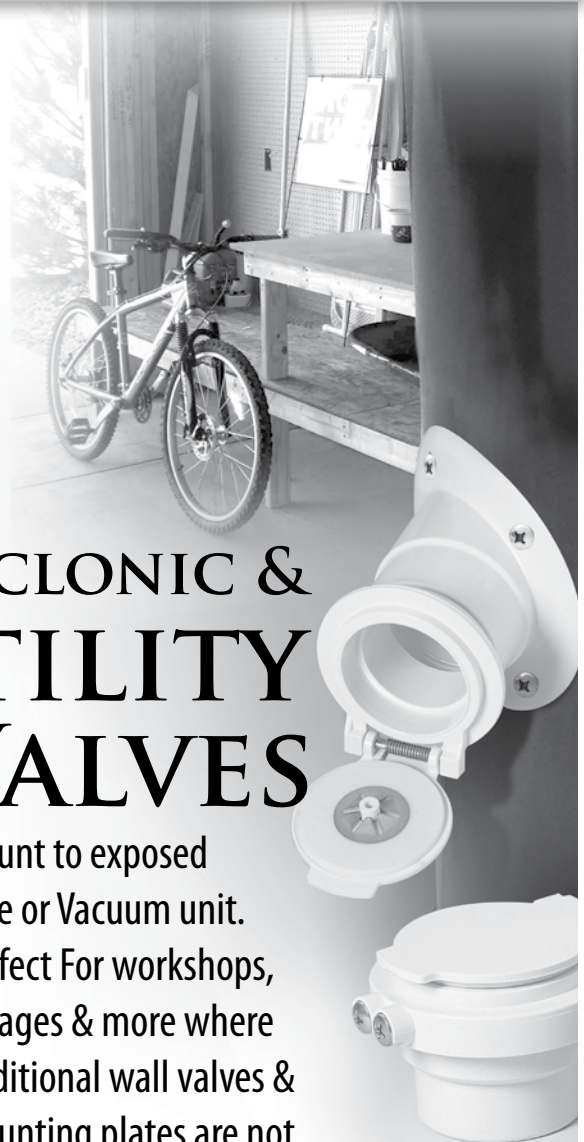

CYCLONIC & UTILITY VALVES

Mount to exposed pipe or Vacuum unit. Perfect For workshops, garages & more where traditional wall valves & mounting plates are not needed.

2.1 BASIC SEVEN FITTINGS

90° SWEEP ELBOW - SOCKET x SOCKET

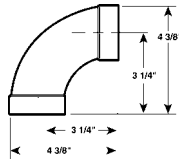
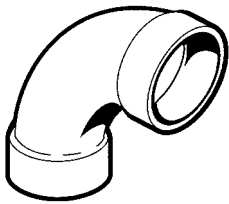

PART #	COLOR.	CTN. QTY.	CTN WT (KGS)	CTN WT (LBS)	CTN CUBIC (M ³)	CTN CUBIC (FT ³)	CTNS / SKID
765510W	White	75	6.37	14.03	0.05	1.72	32

90° SWEEP ELBOW SPIGOT - SOCKET x SPIGOT

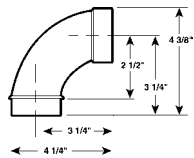
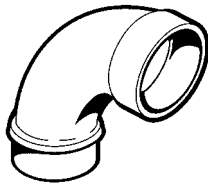

PART #	COLOR.	CTN. QTY.	CTN WT (KGS)	CTN WT (LBS)	CTN CUBIC (M ³)	CTN CUBIC (FT ³)	CTNS / SKID
765511W	White	50	4.02	8.87	0.03	1.15	48

90° SWEEP TEE - SOCKET x SOCKET x SOCKET

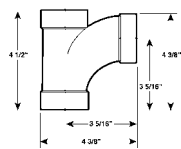
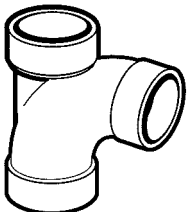

PART #	COLOR.	CTN. QTY.	CTN WT (KGS)	CTN WT (LBS)	CTN CUBIC (M ³)	CTN CUBIC (FT ³)	CTNS / SKID
765501W	White	55	5.70	12.56	0.05	1.72	32

90° SHORT ELBOW - SOCKET x SOCKET

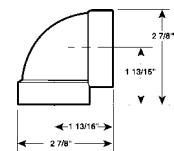
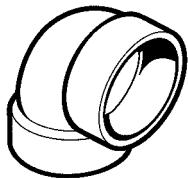

PART #	COLOR.	CTN. QTY.	CTN WT (KGS)	CTN WT (LBS)	CTN CUBIC (M ³)	CTN CUBIC (FT ³)	CTNS / SKID
765506W	White	90	4.92	10.84	0.03	1.15	48

2.1 BASIC SEVEN FITTINGS

45° ELBOW - SOCKET x SOCKET

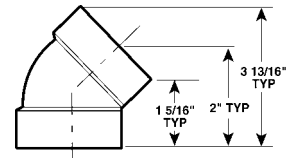
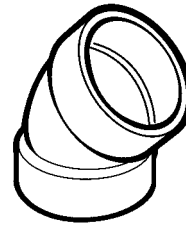

PART #	COLOR.	CTN. QTY.	CTN WT (KGS)	CTN WT (LBS)	CTN CUBIC (M ³)	CTN CUBIC (FT ³)	CTNS / SKID
765517W	White	80	3.04	6.71	0.02	0.79	72

45° ELBOW SPIGOT - SOCKET x SPIGOT

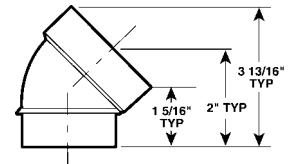
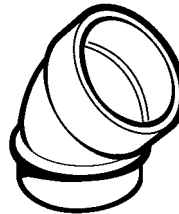

PART #	COLOR.	CTN. QTY.	CTN WT (KGS)	CTN WT (LBS)	CTN CUBIC (M ³)	CTN CUBIC (FT ³)	CTNS / SKID
765518W	White	80	2.78	6.13	0.02	0.79	72

STOP COUPLING - SOCKET x SOCKET

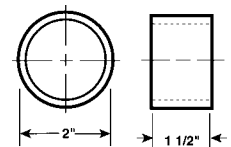
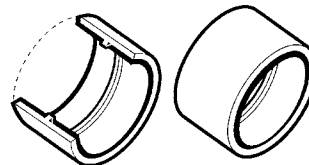

PART #	COLOR.	CTN. QTY.	CTN WT (KGS)	CTN WT (LBS)	CTN CUBIC (M ³)	CTN CUBIC (FT ³)	CTNS / SKID
765529W	White	175	4.23	9.33	0.03	1.15	48

2.2 SPECIALTY FITTINGS

90° EXTRA SHORT ELBOW - SOCKET x SOCKET

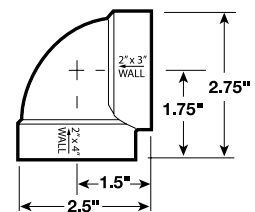
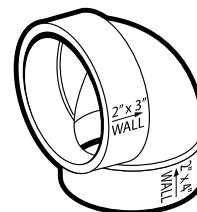

PART #	COLOR.	CTN. QTY.	CTN WT (KGS)	CTN WT (LBS)	CTN CUBIC (M ³)	CTN CUBIC (FT ³)	CTNS / SKID
765503W	White	125	6.42	14.14	0.03	1.15	48

WE'VE GOT THE SHORT STUFF



INTRODUCES
THE SHORTEST
90° ELBOW TO
OUR LINE...

THE **EXTRA**

SHORT 90

FOR 2" X 3" OR 2" X 4" WALLS

ITEM# 765503W

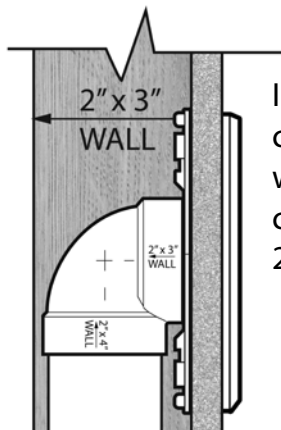

Installers have one more choice, thus their work becomes easier: can be used for either 2" x 3" wall or 2" x 4" wall.

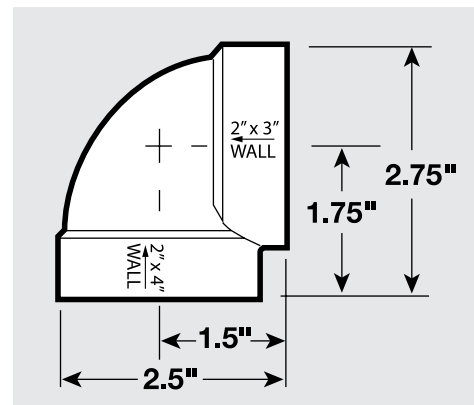

Fittings

2.2 SPECIALTY FITTINGS

90° SHORT ELBOW WITH SHORT SOCKET - SOCKET x SOCKET

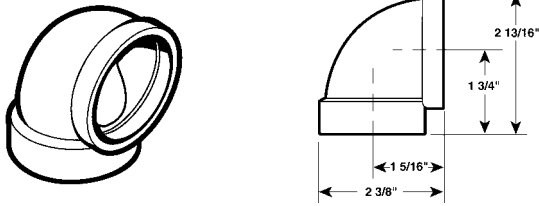

PART #	COLOR.	CTN. QTY.	CTN WT (KGS)	CTN WT (LBS)	CTN CUBIC (M ³)	CTN CUBIC (FT ³)	CTNS / SKID
765504W	White	100	4.72	10.40	0.03	1.15	48

90° SHORT ELBOW SPIGOT - SOCKET x SPIGOT

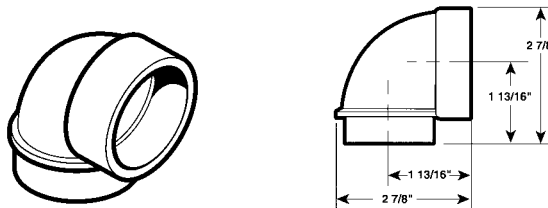

PART #	COLOR.	CTN. QTY.	CTN WT (KGS)	CTN WT (LBS)	CTN CUBIC (M ³)	CTN CUBIC (FT ³)	CTNS / SKID
765507W	White	90	4.49	9.89	0.03	1.15	48

90° MEDIUM SWEEP ELBOW - SOCKET x SOCKET

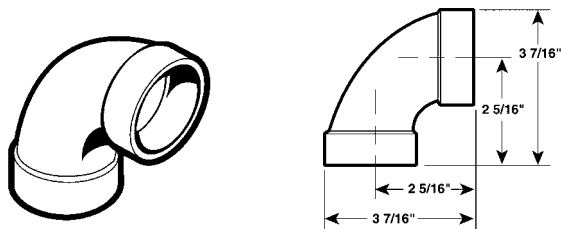

PART #	COLOR.	CTN. QTY.	CTN WT (KGS)	CTN WT (LBS)	CTN CUBIC (M ³)	CTN CUBIC (FT ³)	CTNS / SKID
765508W	White	80	5.13	11.30	0.03	1.15	48

90° MEIDUM SWEEP ELBOW SPIGOT - SOCKET x SPIGOT

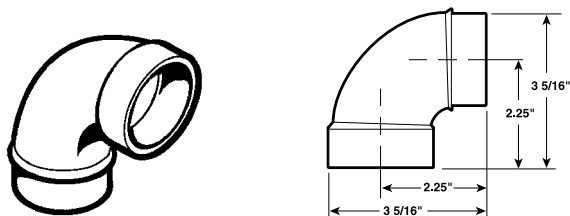

PART #	COLOR.	CTN. QTY.	CTN WT (KGS)	CTN WT (LBS)	CTN CUBIC (M ³)	CTN CUBIC (FT ³)	CTNS / SKID
765509W	White	50	3.10	6.82	0.02	0.79	72

2.2 SPECIALTY FITTINGS

30° ELBOW - SOCKET x SOCKET

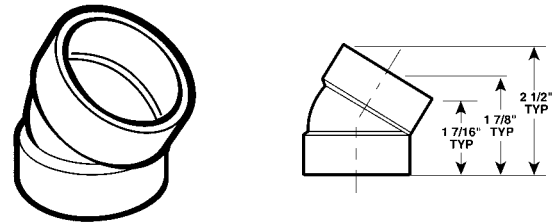

PART #	COLOR.	CTN. QTY.	CTN WT (KGS)	CTN WT (LBS)	CTN CUBIC (M ³)	CTN CUBIC (FT ³)	CTNS / SKID
765519W	White	75	2.88	6.34	0.02	0.79	72

3-WAY 90° ELBOW - SOCKET x SOCKET x SOCKET

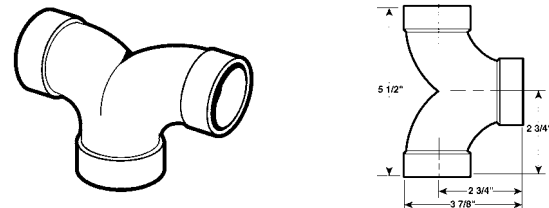

PART #	COLOR.	CTN. QTY.	CTN WT (KGS)	CTN WT (LBS)	CTN CUBIC (M ³)	CTN CUBIC (FT ³)	CTNS / SKID
765515W	White	50	5.63	12.41	0.05	1.72	32

SPIGOT COUPLING - SPIGOT x SPIGOT

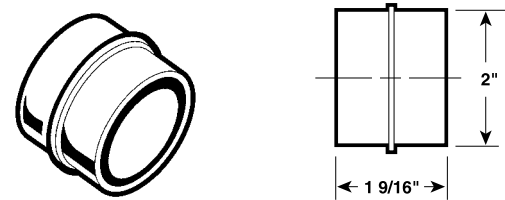

PART #	COLOR.	CTN. QTY.	CTN WT (KGS)	CTN WT (LBS)	CTN CUBIC (M ³)	CTN CUBIC (FT ³)	CTNS / SKID
765527W	White	125	3.07	6.75	0.02	0.79	72

SLIP COUPLING - SOCKET x SOCKET

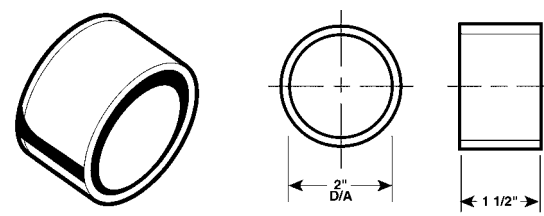

PART #	COLOR.	CTN. QTY.	CTN WT (KGS)	CTN WT (LBS)	CTN CUBIC (M ³)	CTN CUBIC (FT ³)	CTNS / SKID
765528W	White	175	4.31	9.50	0.03	1.15	48

2.0 Fittings



2.3 WYES & TEES

45° WYE - SOCKET x SOCKET x SOCKET

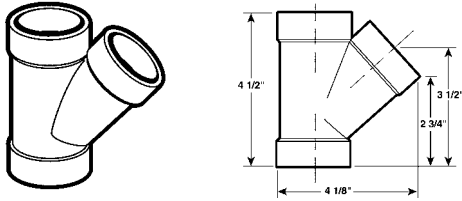

PART #	COLOR.	CTN. QTY.	CTN WT (KGS)	CTN WT (LBS)	CTN CUBIC (M ³)	CTN CUBIC (FT ³)	CTNS / SKID
765525W	White	60	5.88	12.97	0.05	1.72	32

SHORT TEE - SOCKET x SOCKET x SOCKET

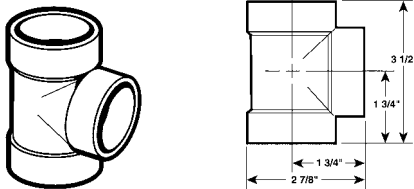

PART #	COLOR.	CTN. QTY.	CTN WT (KGS)	CTN WT (LBS)	CTN CUBIC (M ³)	CTN CUBIC (FT ³)	CTNS / SKID
765502W	White	90	6.79	14.96	0.05	1.72	32

SHORT TEE WITH SHORT SOCKET - SOCKET x SOCKET x SOCKET

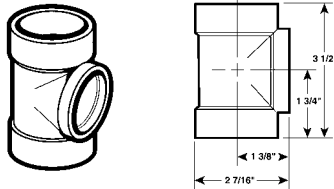

PART #	COLOR.	CTN. QTY.	CTN WT (KGS)	CTN WT (LBS)	CTN CUBIC (M ³)	CTN CUBIC (FT ³)	CTNS / SKID
765502SW	White	90	6.22	13.71	0.05	1.72	32

2.4 FLANGED FITTINGS

FLANGED SOCKET WITH GASKET - FLANGE x SOCKET

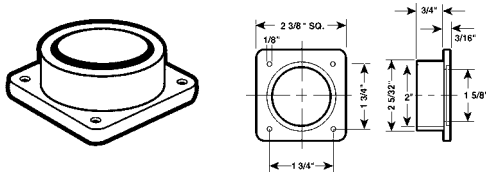

PART #	COLOR.	CTN. QTY.	CTN WT (KGS)	CTN WT (LBS)	CTN CUBIC (M ³)	CTN CUBIC (FT ³)	CTNS / SKID
765550W	White	150	4.46	9.82	0.02	0.79	72

FLANGED SPIGOT WITH GASKET - FLANGE x SPIGOT

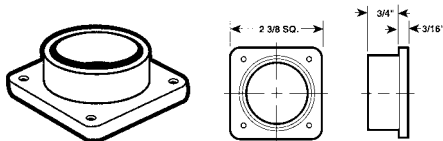

PART #	COLOR.	CTN. QTY.	CTN WT (KGS)	CTN WT (LBS)	CTN CUBIC (M ³)	CTN CUBIC (FT ³)	CTNS / SKID
765555W	White	150	4.37	9.63	0.02	0.79	72

2.4 FLANGED FITTINGS

DOUBLE FLANGED TEE WITH GASKET - FLANGE x FLANGE x SOCKET

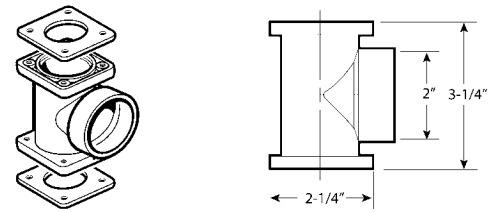

PART #	COLOR.	CTN. QTY.	CTN WT (KGS)	CTN WT (LBS)	CTN CUBIC (M ³)	CTN CUBIC (FT ³)	CTNS / SKID
765551W	White	85	8.05	17.74	0.05	1.72	32

FLANGED TEE WITH GASKET - FLANGE x SOCKET x SOCKET

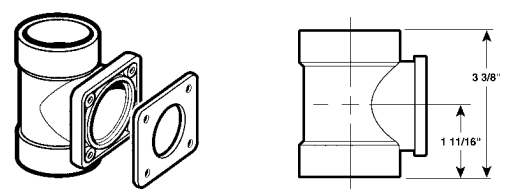

PART #	COLOR.	CTN. QTY.	CTN WT (KGS)	CTN WT (LBS)	CTN CUBIC (M ³)	CTN CUBIC (FT ³)	CTNS / SKID
765552W	White	90	7.71	16.99	0.05	1.72	32

FLANGED 90° LONG ELBOW WITH GASKET - SOCKET x FLANGE

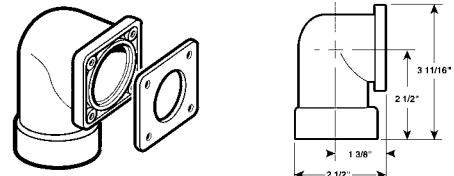

PART #	COLOR.	CTN. QTY.	CTN WT (KGS)	CTN WT (LBS)	CTN CUBIC (M ³)	CTN CUBIC (FT ³)	CTNS / SKID
765553W	White	75	6.15	13.55	0.03	1.15	48

FLANGED 90° SHORT ELBOW WITH GASKET - SOCKET x FLANGE

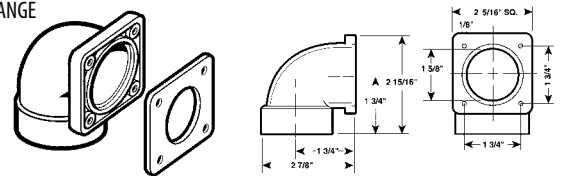

PART #	COLOR.	CTN. QTY.	CTN WT (KGS)	CTN WT (LBS)	CTN CUBIC (M ³)	CTN CUBIC (FT ³)	CTNS / SKID
765556W	White	130	8.92	19.66	0.05	1.72	32

CANISTER INTAKE WITH GASKET - FLANGE x SPIGOT

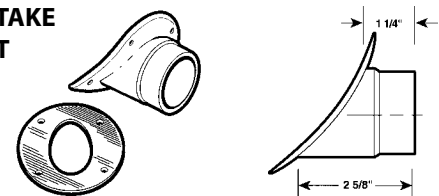

PART #	COLOR.	CTN. QTY.	CTN WT (KGS)	CTN WT (LBS)	CTN CUBIC (M ³)	CTN CUBIC (FT ³)	CTNS / SKID
765597W	White	100	7.23	15.94	0.05	1.72	32

Fittings

2.5 PIPE ACCESSORIES

WIRE CLIP

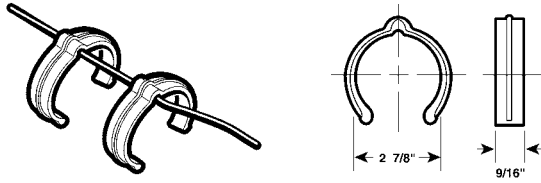

PART #	COLOR.	CTN. QTY.	CTN WT (KGS)	CTN WT (LBS)	CTN CUBIC (M ³)	CTN CUBIC (FT ³)	CTNS / SKID
765544W	White	500	2.66	5.86	0.02	0.79	72

PIPE STRAP

WITH BUILT-IN WIRE HOLDER

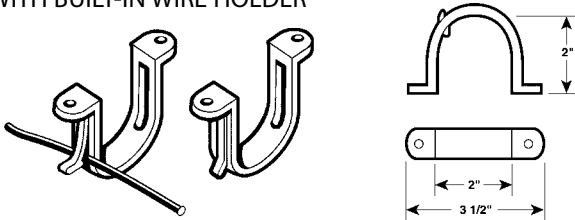

PART #	COLOR.	CTN. QTY.	CTN WT (KGS)	CTN WT (LBS)	CTN CUBIC (M ³)	CTN CUBIC (FT ³)	CTNS / SKID
765545W	White	300	2.85	6.28	0.02	0.79	72

HUP STRAP

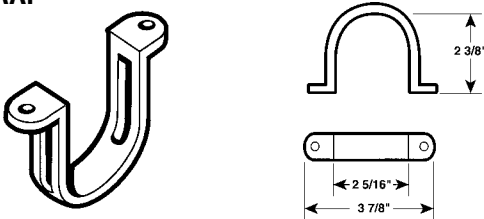

PART #	COLOR.	CTN. QTY.	CTN WT (KGS)	CTN WT (LBS)	CTN CUBIC (M ³)	CTN CUBIC (FT ³)	CTNS / SKID
765548W	White	250	3.34	7.35	0.02	0.79	72

USED TO ANCHOR SOCKET CONNECTIONS

SLIP CAP

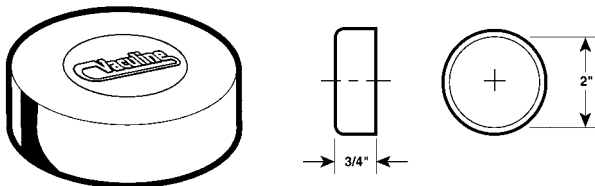

PART #	COLOR.	CTN. QTY.	CTN WT (KGS)	CTN WT (LBS)	CTN CUBIC (M ³)	CTN CUBIC (FT ³)	CTNS / SKID
765547W	White	250	5.01	11.05	0.02	0.79	72

2.6 REDUCERS & ADAPTERS

REDUCER COUPLING - 2" X 1.63"

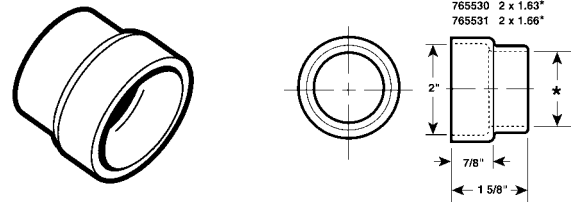

PART #	COLOR.	CTN. QTY.	CTN WT (KGS)	CTN WT (LBS)	CTN CUBIC (M ³)	CTN CUBIC (FT ³)	CTNS / SKID
765530W	White	90	2.65	5.84	0.01	0.38	144

CONNECTS 2" VACUUM PIPE TO 40MM EUROPEAN PIPE

REDUCER COUPLING - 2" X 1.66"

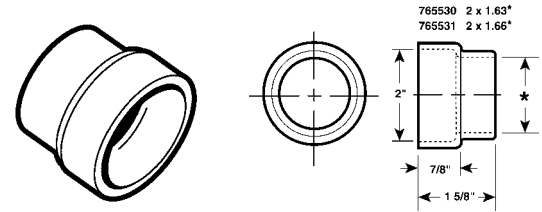

PART #	COLOR.	CTN. QTY.	CTN WT (KGS)	CTN WT (LBS)	CTN CUBIC (M ³)	CTN CUBIC (FT ³)	CTNS / SKID
765531W	White	90	2.44	5.37	0.01	0.38	144

CONNECTS 2" VACUUM PIPE TO 1-1/4" DWV PIPE

REDUCER COUPLING - 2" X 1.825"

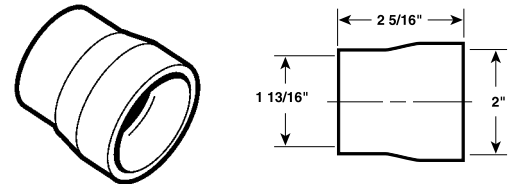

PART #	COLOR.	CTN. QTY.	CTN WT (KGS)	CTN WT (LBS)	CTN CUBIC (M ³)	CTN CUBIC (FT ³)	CTNS / SKID
765532W	White	135	4.91	10.84	0.02	0.79	72

CONNECTS 2" VACUUM PIPE TO 1-1/2" FLEXIBLE PLASTIC HOSE

REDUCER BUSHING - 2" x 1.66"

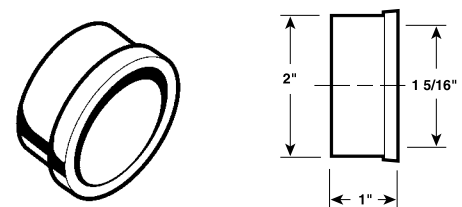

PART #	COLOR.	CTN. QTY.	CTN WT (KGS)	CTN WT (LBS)	CTN CUBIC (M ³)	CTN CUBIC (FT ³)	CTNS / SKID
765537W	White	100	2.50	5.50	0.01	0.38	144

1-1/2" SPIGOT x 2" SOCKET ADAPTER THAT GOES INSIDE A 1-1/2" DWV SOCKET AND CONNECTS TO 2" VACUUM PIPE

2.0 Fittings



2.6 REDUCERS & ADAPTERS

INLET VALVE EXTENSION - 2" x 1.66"

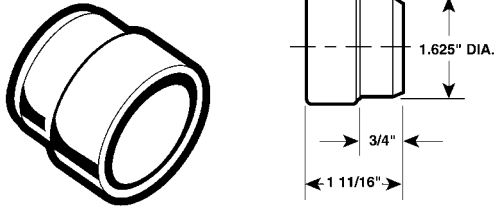

PART #	COLOR.	CTN. QTY.	CTN WT (KGS)	CTN WT (LBS)	CTN CUBIC (M ³)	CTN CUBIC (FT ³)	CTNS / SKID
765541W	White	100	1.99	4.4	0.01	0.38	144

CONNECTS SPIGOT OF VALVE TO MOUNTING PLATE WHERE WALL FINISHING MATERIALS ARE THICKER

FLEXIBLE PIPE LINK ADAPTER

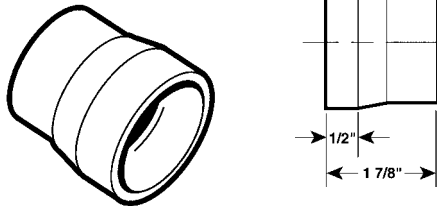

PART #	COLOR.	CTN. QTY.	USE WITH FLEXIBLE TUBING TO CONNECT VACUSWEEP TO PIPING SYSTEM. DO NOT GLUE				
765526	Black	200					

2" x 3" ADAPTER - SOCKET x SOCKET

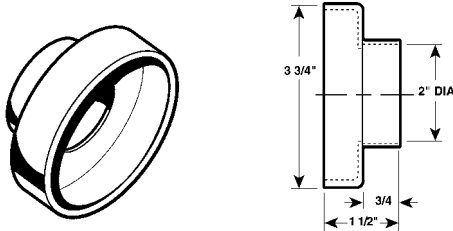

PART #	COLOR.	CTN. QTY.	CTN WT (KGS)	CTN WT (LBS)	CTN CUBIC (M ³)	CTN CUBIC (FT ³)	CTNS / SKID
765570W	White	70	3.50	7.72	0.02	0.79	72

CONNECTS 2" CENTRAL VACUUM PIPE TO 3" DWV PIPE

BAG ADAPTER - SPIGOT x ADAPTER

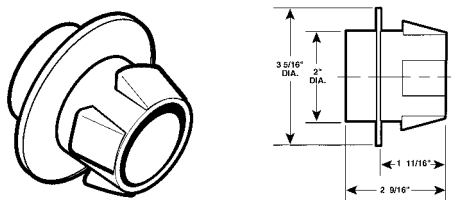

PART #	COLOR.	CTN. QTY.	CTN WT (KGS)	CTN WT (LBS)	CTN CUBIC (M ³)	CTN CUBIC (FT ³)	CTNS / SKID
765542W	White	75	4.64	10.23	0.03	1.15	48

2.6 REDUCERS & ADAPTERS

50MM ADAPTER

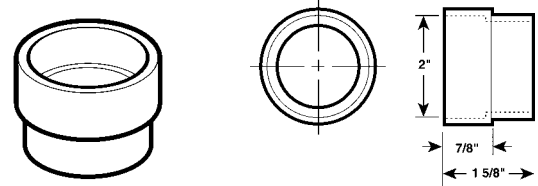

PART #	COLOR.	CTN. QTY.	CTN WT (KGS)	CTN WT (LBS)	CTN CUBIC (M ³)	CTN CUBIC (FT ³)	CTNS / SKID
765535W	White	125	3.53	7.78	0.02	0.79	72

CONNECTS 2" VACUUM PIPE TO 50MM EUROPEAN PIPE

2.7 MUFFLERS & EXHAUST VENT

SQUARE MUFFLER - SOCKET x SOCKET

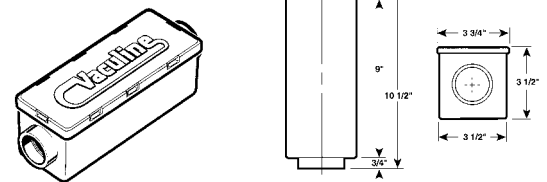

PART #	COLOR.	CTN. QTY.	CTN WT (KGS)	CTN WT (LBS)	CTN CUBIC (M ³)	CTN CUBIC (FT ³)	CTNS / SKID
765500W	White	12	4.89	10.77	0.03	1.15	48
785500BLANK	Black	12	3.66	8.06	0.03	1.15	48

EXHAUST VENT - SOCKET x VENT

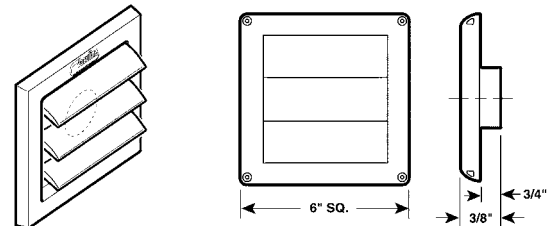

PART #	COLOR.	CTN. QTY.	CTN WT (KGS)	CTN WT (LBS)	CTN CUBIC (M ³)	CTN CUBIC (FT ³)	CTNS / SKID
765540W	White	25	2.68	5.91	0.02	0.79	72



Fittings

3.1 MOUNTING PLATES

PLASTIC MOUNTING PLATE - WITH 3/4" SPIGOT

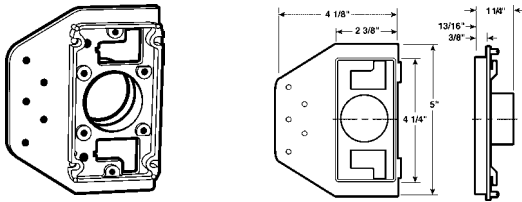

PART #	COLOR.	CTN. QTY.	CTN WT (KGS)	CTN WT (LBS)	CTN CUBIC (M ³)	CTN CUBIC (FT ³)	CTNS / SKID
765568W	White	75	4.69	10.34	0.03	1.15	48

FOR USE WITH 2" X 4" INSTALLATION

PLASTIC MOUNTING PLATE - WITH 1/4" SPIGOT

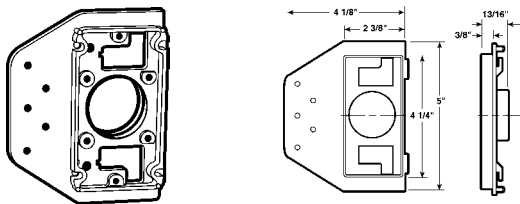

PART #	COLOR.	CTN. QTY.	CTN WT (KGS)	CTN WT (LBS)	CTN CUBIC (M ³)	CTN CUBIC (FT ³)	CTNS / SKID
765568SW	White	64	3.53	7.78	0.02	0.79	72

FOR USE WITH 2" X 3" INSTALLATION

MOUNTING PLATE WITH STEEL BREAKAWAY FLANGE - 3/4" SPIGOT

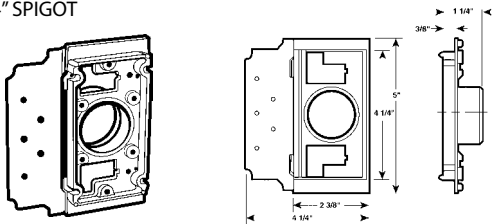

PART #	COLOR.	CTN. QTY.	CTN WT (KGS)	CTN WT (LBS)	CTN CUBIC (M ³)	CTN CUBIC (FT ³)	CTNS / SKID
765566W	White	64	5.63	12.40	0.02	0.79	72

FOR USE WITH 2" X 4" INSTALLATION

MOUNTING PLATE WITH STEEL BREAKAWAY FLANGE - 1/4" SPIGOT

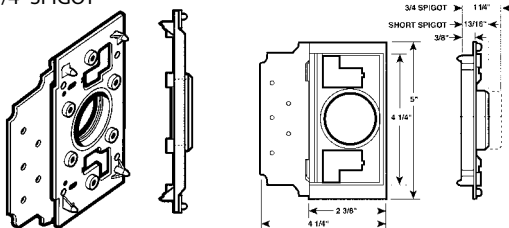

PART #	COLOR.	CTN. QTY.	CTN WT (KGS)	CTN WT (LBS)	CTN CUBIC (M ³)	CTN CUBIC (FT ³)	CTNS / SKID
765567W	White	64	5.22	11.50	0.02	0.79	72

FOR USE WITH 2" X 3" INSTALLATION

3.1 MOUNTING PLATES

FULL METAL MOUNTING PLATE

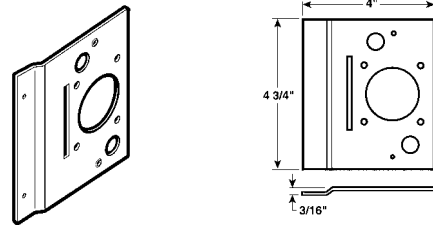

PART #	COLOR.	CTN. QTY.	CTN WT (KGS)	CTN WT (LBS)	CTN CUBIC (M ³)	CTN CUBIC (FT ³)	CTNS / SKID
765560N	Steel	150	-	-	-	-	-

METAL MOUNTING PLATE WITH 3/4" SPIGOT FLANGE

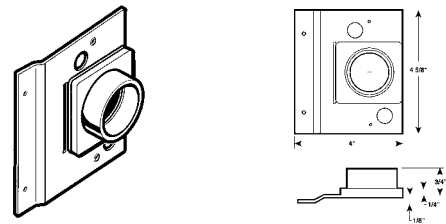

PART #	COLOR.	CTN. QTY.	CTN WT (KGS)	CTN WT (LBS)	CTN CUBIC (M ³)	CTN CUBIC (FT ³)	CTNS / SKID
765565W	White	64	5.78	12.74	0.02	0.79	72

ES MOUNTING PLATE WITH PLASTER GAURD

- FOR CONCRETE WALLS

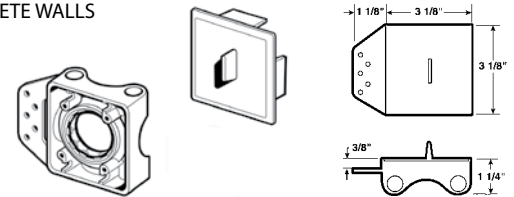

PART #	COLOR.	CTN. QTY.	CTN WT (KGS)	CTN WT (LBS)	CTN CUBIC (M ³)	CTN CUBIC (FT ³)	CTNS / SKID
1/4" SPIGOT							
765569W	White	60	4.19	9.24	0.02	0.79	72

3/4" SPIGOT

765569LW	White	60	4.24	9.35	0.02	0.79	72
----------	-------	----	------	------	------	------	----

1/4" SHORT SPIGOT FOR USE WITH SHORT SOCKET ELBOW (765504W) AND SHORT SOCKET TEE (765502S). FOR 2" X 3" INSTALLATIONS.

ES MOUNTING PLATE - FOR STUD WALLS

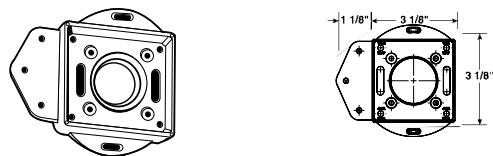

PART #	COLOR.	CTN. QTY.	CTN WT (KGS)	CTN WT (LBS)	CTN CUBIC (M ³)	CTN CUBIC (FT ³)	CTNS / SKID
3/4" SPIGOT							
765564LW	White	60	2.50	5.50	0.02	0.79	72

4.0 Guards & Plates



4.1 PLASTER GUARDS

PLASTER GUARD

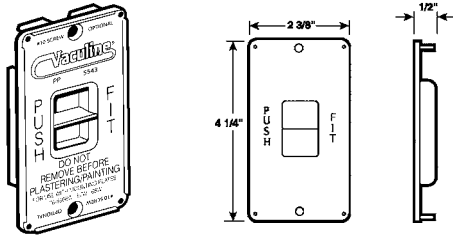

PART #	COLOR.	CTN. QTY.	CTN WT (KGS)	CTN WT (LBS)	CTN CUBIC (M ³)	CTN CUBIC (FT ³)	CTNS / SKID
765543BLK	Black	100	2.00	4.41	0.02	0.79	72

FITS MOST MOUNTING PLATES

PLASTER GUARD

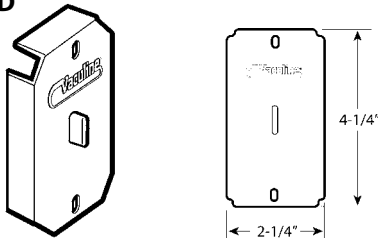

PART #	COLOR.	CTN. QTY.	CTN WT (KGS)	CTN WT (LBS)	CTN CUBIC (M ³)	CTN CUBIC (FT ³)	CTNS / SKID
765546W	White	75	1.57	3.46	0.02	0.79	72

FITS METAL MOUNTING PLATE 765560N

ES PLASTER GUARD

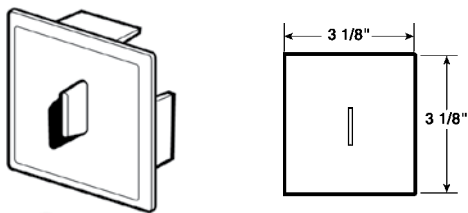

PART #	COLOR.	CTN. QTY.	CTN WT (KGS)	CTN WT (LBS)	CTN CUBIC (M ³)	CTN CUBIC (FT ³)	CTNS / SKID
765569-2W	White	100	2.06	4.53	0.02	0.79	72

FITS MOST ES MOUNTING PLATES

4.2 ROUGH-IN PLATES

ROUGH-IN COVER PLATE WITH SCREWS

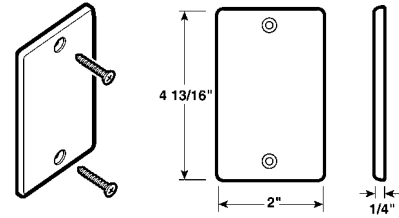

PART #	COLOR.	CTN. QTY.	CTN WT (KGS)	CTN WT (LBS)	CTN CUBIC (M ³)	CTN CUBIC (FT ³)	CTNS / SKID
765585W	White	120	3.65	8.05	0.01	0.38	144
765585	Ivory	120	3.68	8.11	0.01	0.38	144
765585A	Almond	120	3.67	8.20	0.01	0.38	144

Guards & Plates



LIGHTWEIGHT, CRUSHPROOF HOSES



FEATURING NEW REVERSIBLE CUFF
 The cuff of the hose is easily convertible between Pig Tail Corded and Direct Connect.

NEW

HOSES

1-3/8" HOSE DIAMETER
 Provides 11% more airflow than the standard 1-1/4" hose

Direct Connect



Strain Relief
 to prevent hose kinks



Air Management
 to control suction

Pigtail Corded

With 6 ft. Cord



PART #	HOSE LENGTH	COLOUR	NUMBER OF WIRES	CUFF TYPE
855830BUVRV	30 FT	Black	4 Wires - Dual Voltage	Pig Tail Corded
855830BUVDC	30 FT	Black	4 Wires - Dual Voltage	Direct Connect
855835BUVRV	35 FT	Black	4 Wires - Dual Voltage	Pig Tail Corded
855835BUVDC	35 FT	Black	4 Wires - Dual Voltage	Direct Connect
855830BLV	30 FT	Black	2 Wires - Low Voltage	Universal
855835BLV	35FT	Black	2 Wires - Low Voltage	Universal

6.0 Installation Kits

5.1 INSTALLATION KITS

VACUVALVE 3 INLET KIT

INCLUDES:

- 3 - INLET VALVES
- 9 - 90° SWEEP ELBOWS
- 6 - 45° ELBOWS
- 6 - COUPLINGS
- 6 - PIPE STRAPS
- 2 oz. CEMENT
- 3 - PLASTIC MOUNTING PLATES WITH 3/4" SPIGOT
- 1 - FULLY ILLUSTRATED INSTRUCTION MANUAL

- 3 - 90° SHORT ELBOWS
- 2 - 90° SWEEP TEES
- 15 - QUICK CLIPS
- 60 FOOT LOW VOLTAGE WIRE
- 6 - WIRE CONNECTORS

NOTE: LOW VOLTAGE WIRE IS PLT-C, 18-2, UL AND CSA APPROVED



PART #	COLOR.	CTN. QTY.	CTN WT (KGS)	CTN WT (LBS)	CTN CUBIC (M ³)	CTN CUBIC (FT ³)	CTNS / SKID
765593WWC	White	1	3.11	6.86	0.02	0.79	72

5.1 INSTALLATION KITS

VACUSWEEP UNDERCOUNTER INSTALLATION KIT

INCLUDES:

- 1 - VACUSWEEP INLET VALVE
- 4' FLEXIBLE HOSE
- 2 - HOSE CLAMPS
- 1 - TRIM PLATE
- 2 - PIPE LINK ADAPTERS



PART #	COLOR.	CTN. QTY.	CTN WT (KGS)	CTN WT (LBS)	CTN CUBIC (M ³)	CTN CUBIC (FT ³)	CTNS / SKID
775700W	White	7	8.54	18.15	0.09	3.15	18
775700	Ivory	7	7.73	17.10	0.09	3.15	18
775700A	Almond	7	8.10	17.90	0.09	3.15	18
775700BLK	Black	7	8.02	18.1	0.09	3.15	18
775700S	Stainless Steel	7	8.02	17.68	0.09	3.15	18

INDEX

PART #	PAGE #	PART #	PAGE #	PART #	PAGE #	PART #	PAGE #
765500W	14	765556W	12	775592A	7		
765501W	9	765560N	15	775592BLK	7		
765502SW	12	765564LW	15	775592W	7		
765502W	12	765565W	15	775594-12-3	4		
765503W	9	765566W	15	775594-14-3	4		
765504W	11	765567W	15	775595RKKV3	4		
765506W	9	765568SW	15	775595RKKV4	4		
765507W	11	765568W	15	775595V3W	4		
765508W	11	765569LW	15	775595V3	4		
765509W	11	765569W	15	775595V3A	4		
765510W	9	765570W	14	775595V3BLK	4		
765511W	9	765585A	16	775600	4		
765515W	11	765585W	16	775600A	4		
765517W	9	765593WWC	16	775600BLK	4		
765518W	9	765597W	12	775600S	4		
765519W	11	775583	8	775600W	4		
765525W	12	775583W	8	775601	4		
765526	14	775584	8	775601A	4		
765527W	11	775584BLK	8	775601BLK	4		
765528W	11	775584W	8	775601S	4		
765529W	9	775585L	8	775601W	4		
765530W	13	775585LW	8	775602	4		
765531W	13	775585R	8	775700-1	4		
765532W	13	775586	8	775892A	7		
765537W	13	775586BLK	8	775892GM	7		
765540W	14	775586W	8	775892OB	7		
765541W	14	775588	7	775892P	7		
765542W	14	775588A	7	775892PR	7		
765543BLK	16	775588BLK	7	775892S	7		
765544W	13	775588W	7	775892W	7		
765545W	13	775589	7	855830BLV	17		
765546W	16	775589A	7	855830BUVDC	17		
765547W	13	775589BLK	7	855830BUVRV	17		
765548W	13	775589W	7	855835BLV	17		
765550W	12	775590	7	855835BUVDC	17		
765551W	12	775590A	7	855835BUVRV	17		
765552W	12	775590BLK	7				
765553W	12	775590W	7				
765555W	12	775592	7				

CAUTION

Canplas® does not recommend the use of thermoplastic piping systems for transport or storage of compressed air or other compressed gasses or the testing of such systems with compressed air or other ground locations.

Use of our plastic piping products in exposed compressed gas systems voids our warranty on the products used.

For further information, please contact your Canplas® representative.

WARRANTY

Seller's products are carefully inspected for manufacturing defects. However, it is not always possible to detect hidden defects. Said products are warranted only to the extent that the seller will replace, without charge, products proven to have manufacturing defects, within six (6) months of the date of delivery thereof and provided seller has been given an opportunity to inspect the product alleged to be defective and the installation of use thereof.

NO WARRANTY is included against any expense for removal, reinstallation or other consequential damages arising from any defect.

The warranties set out above are the only warranties made by the seller and are expressly in lieu of any other warranties, expressed or implied including the warranties of merchantability and fitness for a particular purpose.

Vaculine®, VacuSweep®, ES® Valve, ElectraValve® and VacuValve® are registered trademarks of Canplas Industries Ltd.

IAPMO RESEARCH & TESTING, INC.

LISTED PRODUCTS

5001 E. Philadelphia Street, Ontario, CA 91761-2816
(909) 472-4100 • Fax (909) 472-4244 • www.iapmo.org

PRODUCT: Central Vacuum Fittings

APPLICANT: CANPLAS INDUSTRIES
31 PATTERSON ROAD
BARRIE, ON L4M 4V3 CANADA FILE NO. M-4487



IDENTIFICATION: Tube shall be marked at least every 5 ft. in letters not less than 3/16 high in a contrasting colour with the manufacturer's name, ASTM F2158, nominal tube size and material identification. Fittings shall bear the manufacturer's name, ASTM F2158, nominal tube size and material identification. Markings shall be legible after installation. All listed products shall bear the Uniform Mechanical Code (UMC®).

CHARACTERISTICS: Residential central vacuum tube and fittings manufactured in compliance with ASTM F2158-01. To be installed in accordance with the manufacturer's installation instructions and the requirements of the latest edition of the Uniform Mechanical Code.

MODELS:	PART NO.	DESCRIPTION
	765501W	90° Tee S x S x S 2"
	765502W	Short Tee S x S x S 2"
	765506W	90° Short Ell S x S 2"
	765508W	90° Medium Sweep Ell S x S 2"
	765509W	90° Medium Sweep Ell Spg x S 2"
	765510W	90° Sweep Ell S x S 2"
	765511W	90° Sweep Ell Spg x S 2"
	765515W	3-Way 90° Ell S x S x S 2"
	765517W	45° Ell S x S 2"
	765518W	45° Ell Spg x S 2"
	765519W	30° Ell S x S 2"
	765525W	45° Wye S x S x S 2"
	765529W	Coupling S x S 2"
	765547W	Cap S 2"
	765527W	Spigot Adapter S x S 2" (Grey)



canplas®

**Toll Free Number:
1-800-501-5018**

Canplas Industries Ltd.
Head Office
P.O. Box 1800, 500 Veterans Drive
Barrie, Ontario
Canada L4M 4V3

Canplas LLC
11402 East 53rd Ave.
Suite 200, Denver, CO
U.S.A. 80239

Toll Free: 1-800-501-5018
Website: www.vaculine.com
Email: vaculine@canplas.com



Visit us on the Web:
www.vaculine.com
www.canplas.com



Canplas Industries Ltd. has produced this catalogue on paper that ensures environmentally responsible, socially acceptable and economically viable forestry. In part, FSC certification guarantees that this paper was produced in a way that conserves biological diversity, water resources, soils and unique and fragile ecosystems and landscapes so that ecological functions and the integrity of the forest are maintained.

an *Aliaxis* company