

# 19" 2-Post Distribution Rack

## INSTALLATION INSTRUCTIONS

ICC's 2-post racks are designed to be lightweight, sturdy, and easy to install. These high quality, black powder coated aluminum racks will support most EIA 19" rack mountable network devices and hardware such as servers, switches, PBX systems, and other equipments.

Item No.	Height	RMU*	RMU Markings
ICCMSR1948	4 feet	24 RMS	Yes
ICCMSR1972	6 feet	38 RMS	Yes
ICCMSR1984	7 feet	45 RMS	Yes

\*Rack Mount Units

**Hardware Included**

- (2) Top angles - Aluminum
- (2) Base angles - Aluminum
- (2) Vertical mounting rails - Aluminum
- (12) 3/8-16 bolts, black oxide
- (12) lock washers, black oxide
- (12) 3/8-16 nuts, black oxide

**Certification**

EIA 310-D Compliant

**New Feature!**

ICC's Rack Mount Unit (RMU) numbered markings provide consistent vertical alignment and spacing of equipment attachment points for panels, shelves, cable management and associated equipment. RMU numbered markings begin from the bottom to the top of rails for consistent positioning regardless of rack height.

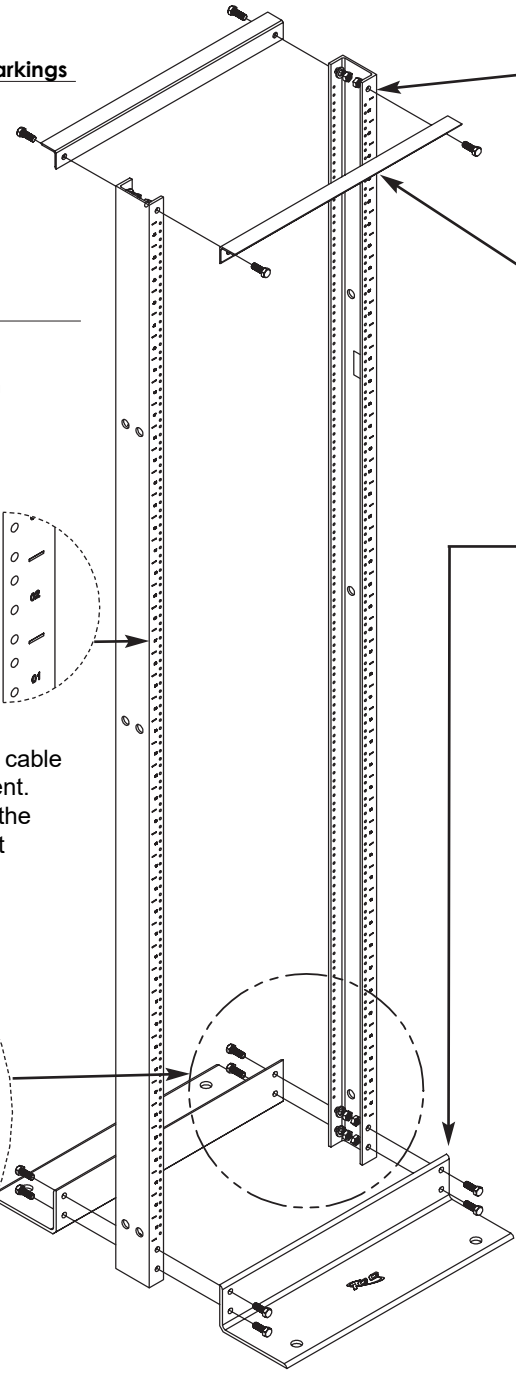
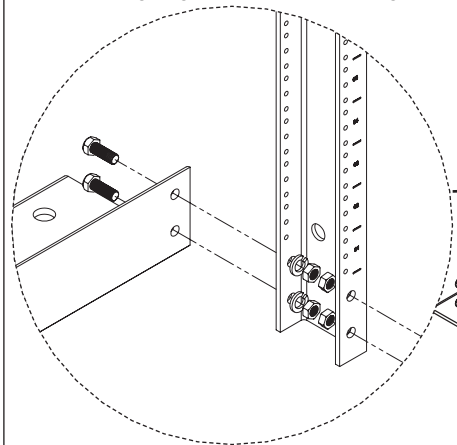
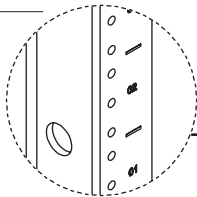

1. Lay the vertical mounting rails on a flat surface with the open channels facing inward.

2. Place one top angle across the top end of the vertical mounting rails. Install two 3/8-16 bolts, lock washers, and nuts as illustrated. **Hand tighten only!**

3. Place one base angle across the bottom end of the vertical mounting rails. Install four 3/8-16 bolts, lock washers, and nuts as illustrated. **Hand tighten only!**

4. Turn the assembly over and repeat steps 2 & 3 for the other side.
5. Stand the assembly up to check for squareness. Make sure the base is level and will rest on a flat surface.
6. Tighten the bolts and torque to approximately 23-30 lb-ft.
7. Anchor the distribution rack assembly to rigid flooring utilizing the four holes on the base angles.

**Note:** Tapped holes are 12-24 threads. Products to be mounted to these rack assemblies should have their own 12-24 mounting screw. ICC provides additional screws in bags of 25 pieces as item number ICACSS01BK.

Premium Products • Proven Performance • Competitive Prices

CUSTOMER CARE / TECHNICAL SUPPORT • CSR@ICC.COM / 888-275-4422 (ASK-4-ICC) • WWW.ICC.COM

## RELATED PRODUCTS

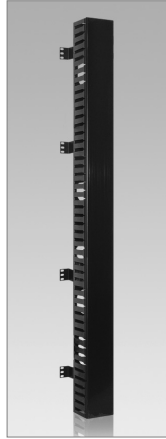

ICCMSCMA81



ICCMSCMA82



ICCMSCMA83

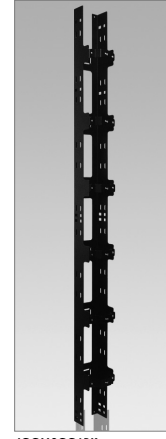

ICCMSCC6BK

### Vertical Finger Duct Panels & Vertical Cable Management Channel

ICCMSCMA81  
ICCMSCMA82  
ICCMSCMA83  
ICCMSCC6BK

78" ht., 4"x5" slotted front ducts, Side mount design  
78" ht., 4"x5" slotted front and rear ducts, Center mount design  
78" ht., 4"x5" slotted front and rear ducts, Side mount design  
6.5' ht., Cable channel, vertical, black

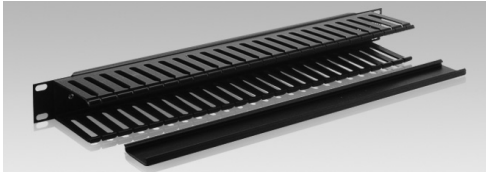

### Horizontal Finger Duct Panel

ICCMSCMA41 Single-Sided Front Ducts, 1 Rack Mount Space  
ICCMSCMA42 Single-Sided Front Ducts, 2 Rack Mount Spaces  
ICCMSCMA61 Double-Sided Dual Ducts, 1 Rack Mount Space  
ICCMSCMA62 Double-Sided Dual Ducts, 2 Rack Mount Spaces



### Horizontal Cable Management Panel

ICCMSCMA31 Horizontal & 2 Vertical Rings, 1 Rack Mount Space  
ICCMSCMA32 Horizontal & 2 Vertical Rings, 1 Rack Mount Space  
ICCMSCMA51 Horizontal Rings, 1 Rack Mount Space  
ICCMSCMA52 3.5" H x 19" W, 2 Rack Mount Spaces 5 horizontal rings  
ICCMSCMC01 Panel cover, 1 Rack Mount Space  
ICCMSCMC02 Panel cover, 2 Rack Mount Spaces

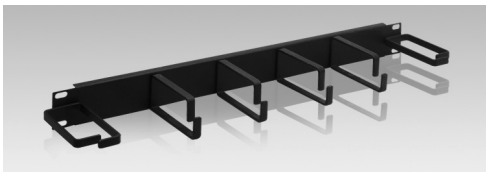

### Horizontal Metal Cable Management Panel

ICCMSCMP31 Horizontal & 2 Side Vertical Rings, 1 Rack Mount Space  
ICCMSCMP32 Horizontal & 4 Side Vertical Rings, 2 Rack Mount Spaces  
ICCMSCMP51 Horizontal Rings, 1 Rack Mount Space  
ICCMSCMP52 Horizontal Rings, 2 Rack Mount Spaces



### Rack Floor Wall Mount Kit, Concrete

ICCMSRFLKT Hardware, Rack, Installation For Concrete Floors and Walls.

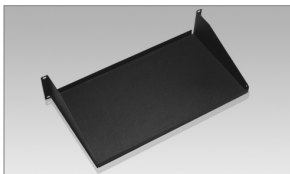

10" Deep Single Rack Shelf  
ICCMRSF10

2 rack mount spaces

Note: For use with 19" distribution and cable management racks

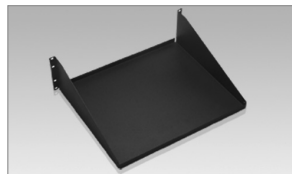

15" Deep Single Rack Shelf  
ICCMRSF15

3 rack mount spaces

Note: For use with 19" distribution and cable management racks

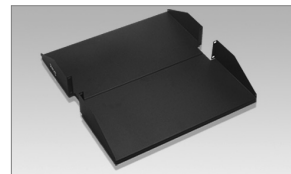

20" Deep Double Rack Shelf  
ICCMRDS20

2 rack mount spaces

Note: For use with 19" distribution racks only

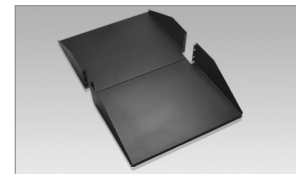

30" Deep Double Rack Shelf  
ICCMRDS30

3 rack mount spaces

Note: For use with 19" distribution racks only

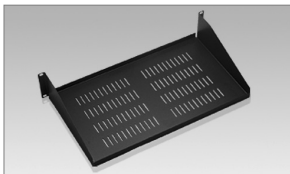

10" Deep Vented Rack Shelf  
ICCMRSV10

2 rack mount spaces

Note: For use with 19" distribution and cable management racks

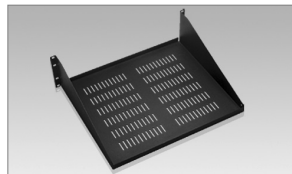

15" Deep Vented Rack Shelf  
ICCMRSV15

3 rack mount spaces

Note: For use with 19" distribution and cable management racks

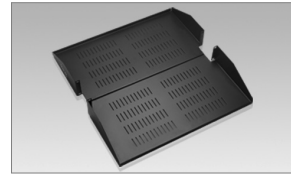

20" Deep Vented Rack Shelf  
ICCMRDV20

2 rack mount spaces

Note: For use with 19" distribution racks only

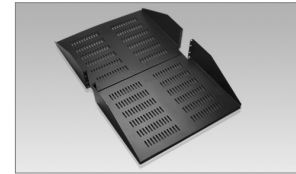

30" Deep Vented Rack Shelf  
ICCMRDV30

3 rack mount spaces

Note: For use with 19" distribution racks only