

Wall Mount Hinged Bracket, 1 RMS

Package Include:

A. Wall Mount Hinged Bracket, **1 Piece**

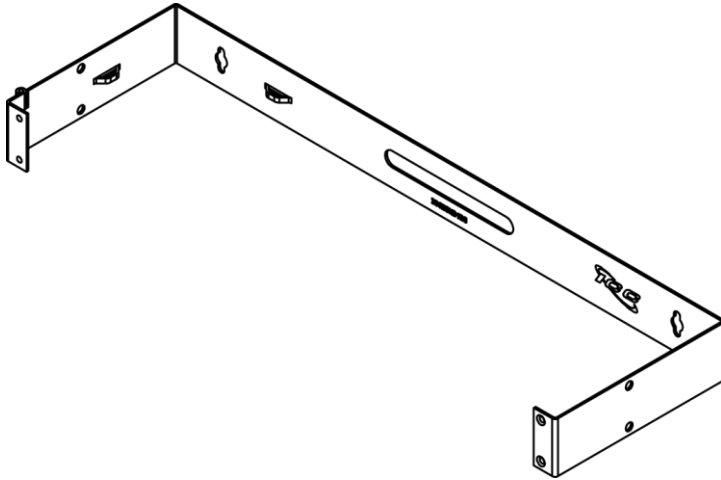

Features and Benefits

- Designed with high quality steel, black powder coating, light weight and sturdy
- Designed with a 6" depth making it ideal for installing voice and data equipment such as patch panels and cable management products creating an organized system.
- Up to 10 lbs. weight capacity when properly secured to the surface
- Ideal for installations with space restrictions
- 1 rack mount space (RMS)
- Compatible with cover ICCMSHBCVR
- Tapped holes are 12-24 threads
- EIA/ECA-310-E compliant

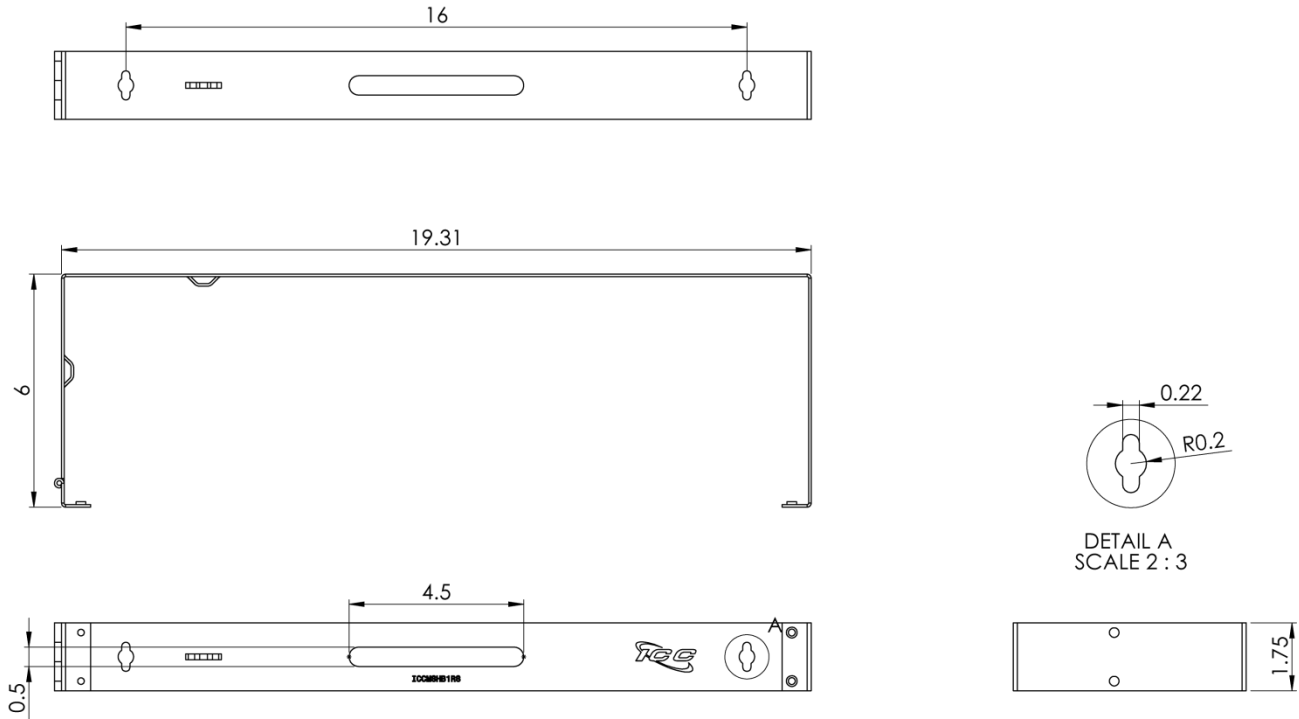

NOTE: UNLESS OTHERWISE SPECIFIED

- Material: 16GA CRS
- Finish: Black powder coat