

6-Port Single Gang Faceplate With Station ID

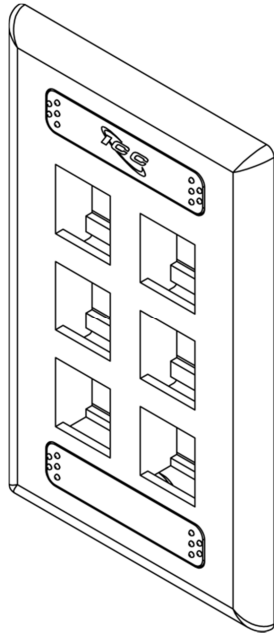

Package Includes:

- A. 6-Port Single Gang Faceplate With Station ID, 1 Piece**
- B. ICC Label Cover, 1 Piece**
- C. Clear Label Cover, 2 Pieces**
- D. Paper ID Label, 2 Pieces**
- E. #6-32 x 3/4" Oval Head, Countersink, Deep Slotted Drive, Machine Screw, 2 Pieces**

Features and Benefits

- Configured to fit standard single gang outlet box
- Designed to support the distribution of voice, data, and other communication needs to the work area for commercial and residential applications
- Rugged and durable construction
- Easy station identification with use of enclosed labels protected by clear plastic covers
- Hidden mounting screws
- Accommodates a wide variety of easy to snap-in modules, providing configuration flexibility
- Accepts all IC107 modules
- ANSI/TIA-568-C and UL 1863 compliant
- Country of Origin: Taiwan
- TAA Compliant

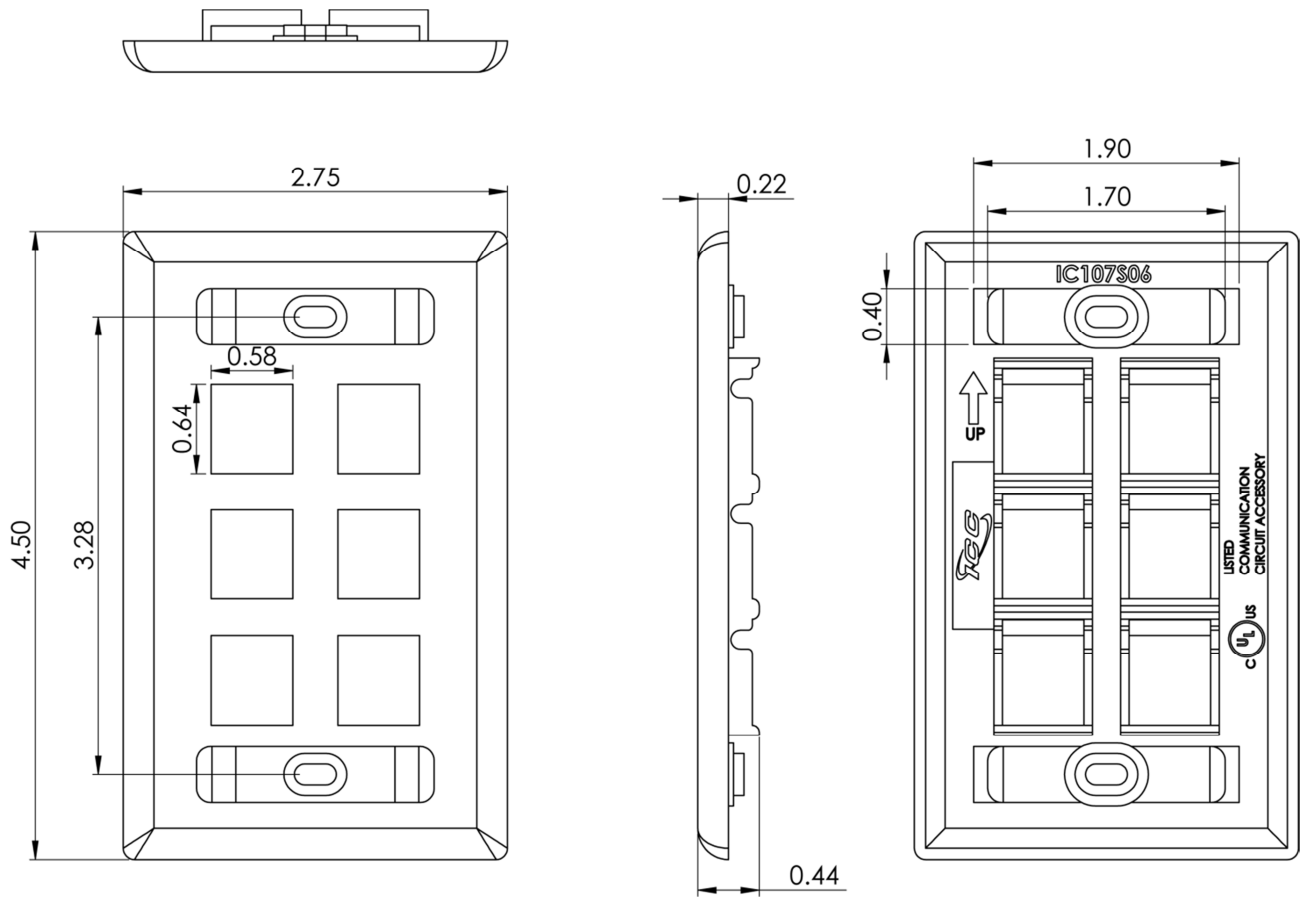

Specifications

- Material: ABS, UL94V-0
- Finish: Texture
- Color: XX: IV-Ivory, WH-White

