

Quick Start Guide

GV-IP Speed Dome



- **GV-QSD5730-Indoor**
- **GV-QSD5730-Outdoor**
- **GV-QSD5731-IR**

Before attempting to connect or operate this product, please read these instructions carefully and save this manual for future use.

QSD-QG-B



© 2021 GeoVision, Inc. All rights reserved.

Under the copyright laws, this manual may not be copied, in whole or in part, without the written consent of GeoVision.

Every effort has been made to ensure that the information in this manual is accurate. GeoVision, Inc. makes no expressed or implied warranty of any kind and assumes no responsibility for errors or omissions. No liability is assumed for incidental or consequential damages arising from the use of the information or products contained herein. Features and specifications are subject to change without notice.

GeoVision, Inc.
9F, No. 246, Sec. 1, Neihu Rd.,
Neihu District, Taipei, Taiwan
Tel: +886-2-8797-8377
Fax: +886-2-8797-8335
<http://www.geovision.com.tw>

Trademarks used in this manual: *GeoVision*, the *GeoVision* logo and *GV* series products are trademarks of GeoVision, Inc. *Windows* is the registered trademark of Microsoft Corporation.

October 2021

Scan the following QR codes for product warranty and technical support policy:



[Warranty]



[Technical Support Policy]

Contents

Note for Connecting to GV-VMS / DVR / NVR	ii
Note for Recording	ii
1. Introduction	1
1.1 Packing List	1
1.2 Overview of GV-QSD5730-Indoor	3
1.3 Overview of GV-QSD5730-Outdoor / GV-QSD5731-IR	4
2. Installation	6
2.1 Installing GV-QSD5730-Indoor	6
2.2 Installing GV-QSD5730-Outdoor / GV-QSD5731-IR	8
3. Connecting the Camera	9
3.1 Power Connection	9
3.2 Audio / Alarm I/O & RS-485 Connection	10
4. Accessing the Camera	11
4.1 System Requirements	11
4.2 Looking Up the Dynamic IP Address	12
4.3 Configuring the IP Address	13
5. The Web Interface	14
5.1 Viewing Live View Video	14
5.2 PTZ Functions	16
6. Upgrading System Firmware	17
7. Restoring to Factory Default	18
7.1 Using the Web Interface	18
7.2 Directly on the Camera	18

Note for Connecting to GV-VMS / DVR / NVR

The GV-IP Speed Dome is designed to work with GV-VMS / DVR / NVR, a video management system. Note the following when the camera is connected to GV-VMS / DVR / NVR:

Once the camera is connected to the GV-VMS / DVR / NVR, the resolution set on the GV-VMS / DVR / NVR will override the resolution set on the camera's Web interface. You can only change the resolution settings through the Web interface when the connection to the GV-VMS / DVR / NVR is interrupted.

Note for Recording

Mind the following when using a memory card for recording:

- Recorded data on the memory card can be damaged or lost if the data are accessed while the camera is under physical shock, power interruption, memory card detachment or when the memory card reaches the end of its lifespan. No guarantee is provided for such causes.
- The stored data can be lost if the memory card is not accessed for a long period of time. Back up your data periodically if you seldom access the memory card.
- Memory cards are expendable and their durability varies according to the conditions of the installed site and how they are used. Back up your data regularly and replace the memory card annually.
- To avoid power outage, it is highly recommended to apply a battery backup (UPS).
- For better performance, it is highly recommended to use Micro SD card of MLC NAND flash, Class 10.
- Replace the memory card when its read/write speed is lower than 6 MB/s or when the memory card is frequently undetected by the camera.
- To ensure smooth network usage, do not access the live view from more than 20 connection.

1. Introduction

Welcome to the *GV-IP Speed Dome Quick Start Guide*. In the following sections, you will learn the basic installations and configurations. For a detailed user manual, see the *GV-IP Speed Dome User's Manual*.

1.1 Packing List

GV-QSD5730-Indoor

- GV-QSD5730-Indoor
- 3-Pin Power Terminal Block



- 14-Pin Alarm/Audio I/O Terminal Block
- Drill Template Paster
- Download Guide
- Warranty Card



GV-QSD5730-Outdoor / GV-QSD5731-IR

- GV-QSD5730-Outdoor / GV-QSD5731-IR



- 3-Pin Power Terminal Block



- M4 Screw with Rubber



- 14-Pin Alarm / Audio I/O Terminal Block

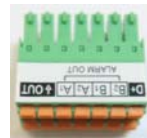

- Pendant cap



- Download Guide

- Warranty Card

Note:

1. It is required to purchase [GV-Mount104-1](#) / [105-1](#) / [210-1](#) / [208-4](#) to mount [GV-QSD5730-Outdoor](#) / [GV-QSD5731-IR](#) to a wall, ceiling or pole.
 2. PoE function is available for [GV-QSD5731-IR](#) only when a [GV-PA902BT](#) Gigabit PoE Adapter is purchased for connection.
-

1.2 Overview of GV-QSD5730-Indoor

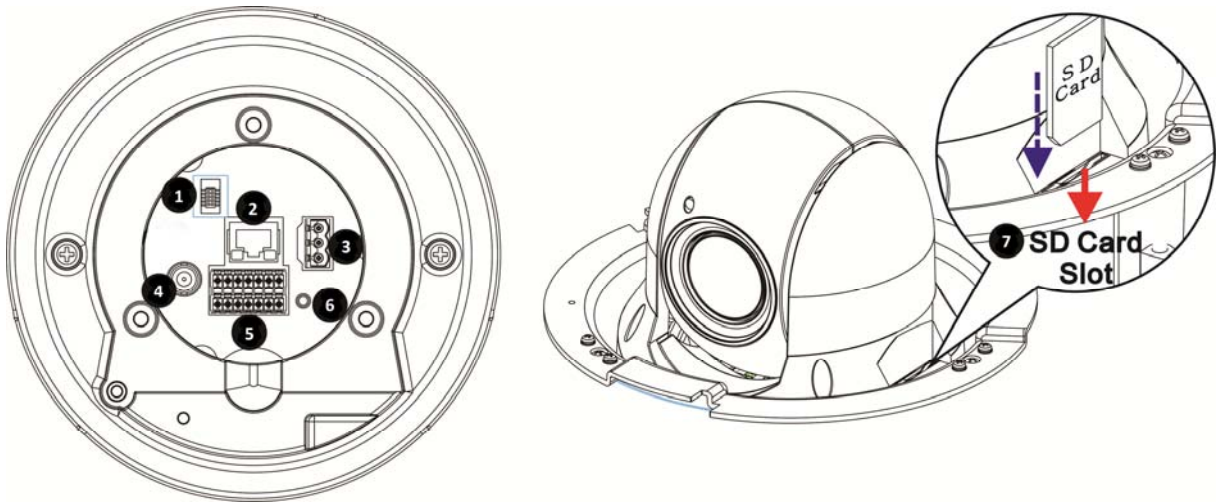

No.	Name	Function
1.	Console Connector	N/A
2.	RJ-45 Port	For network and PoE connection
3.	Power Connector	AC 24V power connection
4.	BNC	For analog video output
5.	Audio/Alarm I/O & RS-485 Connector*	Audio/Alarm I/O & RS-485 connection
6.	Default Button	Press the button with a proper tool for at least 20 seconds to restore the system.
7.	SD Card Slot	Open the dome cover and insert the SD card into the card slot to store videos and snapshots. Do not remove the SD card when the camera is powered on.

Note:

1. Do NOT connect external power supply to the I/O connector of the camera.
2. It is not recommended to record with the SD card for 24/7 continuously, as it may not be able to support long term continuous data read/write.
3. The Audio In port only supports microphones with power supply.

1.3 Overview of GV-QSD5730-Outdoor / GV-QSD5731-IR

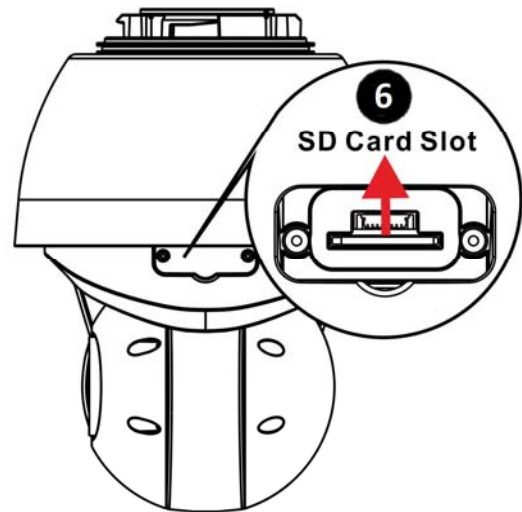
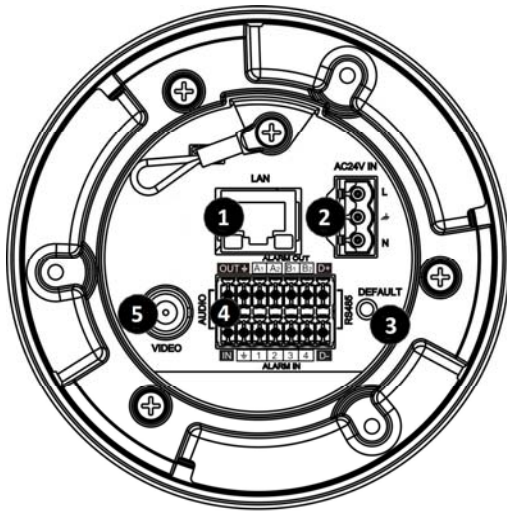

GV-QSD5731-IR

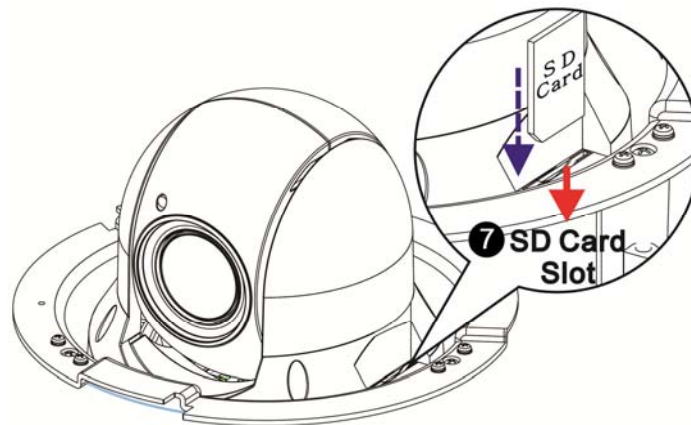

GV-QSD5730-Outdoor

No.	Name	Function
1.	RJ-45 Port	For network and PoE connection
2.	Power Connector	AC 24V power connection
3.	Default Button	Press the button with a proper tool for at least 20 seconds to restore the system.
4.	Audio/Alarm I/O & RS-485 Connector	Audio/Alarm I/O & RS-485 connection
5.	BNC	For analog video output

6.	SD Card Slot	GV-QSD5731-IR	Open the cover of the SD card slot and insert the SD card into the card slot to store videos and snapshots. Do not remove the SD card when the camera is powered on.
7.		GV-QSD5730-Outdoor	Open the dome cover and insert the SD card into the card slot to store videos and snapshots. Do not remove the SD card when the camera is powered on.

Note:

1. Do NOT connect external power supply to the I/O connector of the camera.
 2. It is not recommended to record with the SD card for 24/7 continuously, as it may not be able to support long term continuous data read/write.
 3. The Audio In port only supports microphones with power supply.
-

2. Installation

In the following sections, you will learn how to install GV-QSD5730-Indoor to the ceiling with standard packages and how to install GV-QSD5730-Outdoor / GV-QSD5731-IR with optional GV-Mount accessories.

2.1 Installing GV-QSD5730-Indoor



Required Items

- Tool for drilling a hole on the ceiling (user-prepared)
- M4 Crosshead Screw Driver (user-prepared)
- SD card (user-prepared)

1. Determine a ceiling location for camera installation. Stick the drill template paster to the ceiling, and then drill a hole of radius 192 mm according to the drill template.
2. Remove the dome cover by turning the dome cover counter-clockwise and insert the SD card.



2 Installation

3. Thread the Ethernet, power, and/or I/O cables through the ceiling opening.
4. Connect the Ethernet, power, and/or I/O cables to the camera. Align and put the camera to the ceiling opening.



5. Extend the ceiling clamps and clamp the camera to the ceiling by fastening the three screws clockwise.

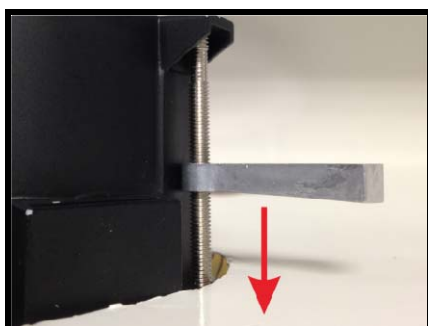

6. Secure the dome cover of the camera by turning the dome cover clockwise.



2.2 Installing GV-QSD5730-Outdoor / GV-QSD5731-IR

Required Items

- GV-Mount104-1 / GV-Mount105-1 / GV-Mount210-1 / GV-Mount208-4 (user-purchased)
 - M4 Crosshead Screw Driver (user-prepared)
 - SD card (user-prepared)
-

1. For **GV-QSD5730-Outdoor**, use a self-prepared screw driver to unscrew the two screws on the dome cover, insert the SD card, put the dome cover back and secure the two screws.
For **GV-QSD5731-IR**, remove the cover of the SD card slot on the side of the camera, insert the SD card, secure the cover of the SD card slot.
2. Thread the Ethernet, power, and/or I/O cables through the GV-Mount of your choice (GV-Mount104-1 / GV-Mount105-1 / GV-Mount210-1 / GV-Mount208-4).
3. Install the GV-Mount at the desired location.
4. Thread the Ethernet, power, and/or I/O cables through the supplied pendant cap.
5. Connect the Ethernet, power, and/or I/O cables to the camera.
6. Attach the pendant cap to the camera and rotate until it is locked into position. Make sure the screw hole on the pendant cap aligns to one of the three screw holes on the base of the camera.
7. Secure the supplied M4 Screw through the aligned screw hole.

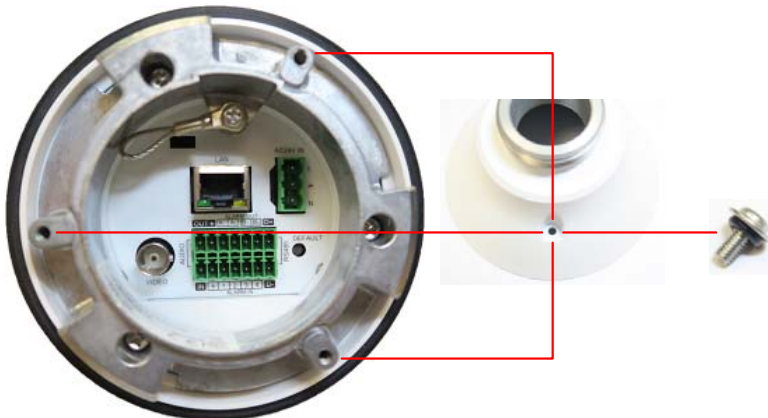

8. Attach the camera to the installed GV-Mount.

For details, see *GV-Mount Accessories Installation Guide*.

3. Connecting the Camera

3.1 Power Connection

To power up the camera, choose one of the following options below.

- Connect the AC 24V power adaptor to the power connector of the camera and the power outlet. The pin definition of the power connector is as below:

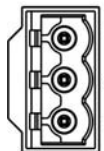

Pin	Definition
1	AC 24V L (White; Positive)
2	GND
3	AC 24V N (Black; Negative)

- Connect one end of the Ethernet cable to the RJ-45 connector of the camera and the other end to a GV-PoE Adapter or PoE switch. For GV-QSD5731-IR, GV-PA902BT is required to apply the PoE function and the following is the illustration of how to connect the camera and the PoE adapter together.

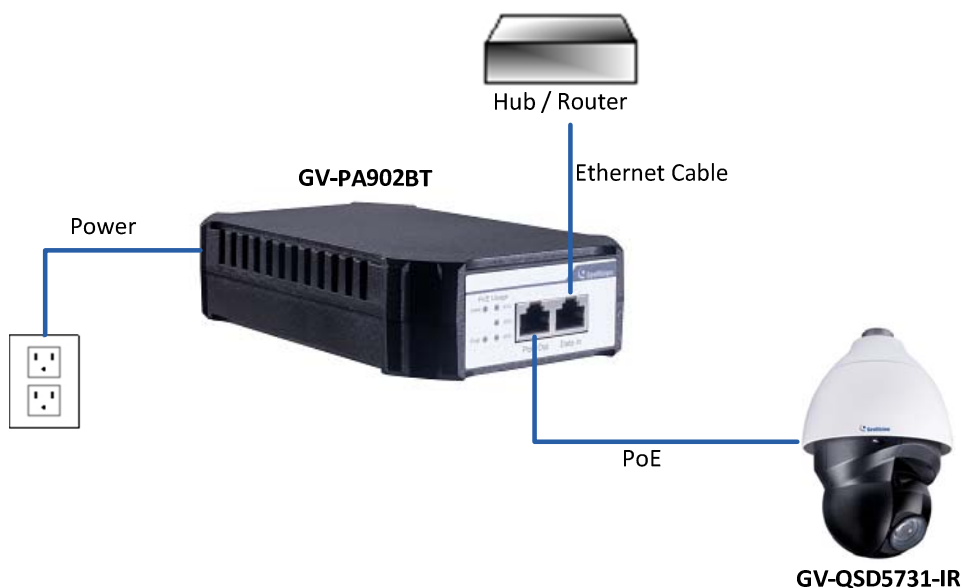

3.2 Audio / Alarm I/O & RS-485 Connection

Pin definition for I/O and RS-485 connection is as below:

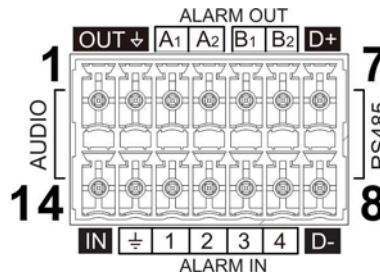

Pin	Definition	Pin	Definition	Pin	Definition	Pin	Definition
1	Audio Out	5	Alarm Out B1	9	Alarm In 4	13	GND (Alarm I/O & RS-485)
2	GND (Audio I/O)	6	Alarm Out B2	10	Alarm In 3	14	Audio In
3	Alarm Out A1	7	RS-485 D+	11	Alarm In 2		
4	Alarm Out A2	8	RS-485 D-	12	Alarm In 1		

4. Accessing the Camera

4.1 System Requirements

Once installed, your camera is accessible over the network. Make sure your PC has good network connection, and meet the following requirements:

Operating System	Windows 7 or later
Memory	Minimum: 4 GB
	Recommended: 8 GB
CPU	Minimum: Intel Core i5-2430M, 2.4 GHz
	Recommended: Intel Core i7-870, 2.93 GHz
Web Browser	<ul style="list-style-type: none"> ● Microsoft Internet Explorer 11.0 (recommended) ● Google Chrome ● Mozilla Firefox ● Microsoft Edge ● Safari

Note: The live view is playable on non-IE browsers only with MJPEG format.

4.2 Looking Up the Dynamic IP Address

By default, when the camera is connected to LAN with a DHCP server, it is automatically assigned with a dynamic IP address. Follow the steps below to look up its IP address and set up a login password.

Note: The PC installed with GV-IP Device Utility must be under the same LAN as your camera.

1. Download and install the **GV-IP Device Utility** program from the company [website](#).
2. On the GV-IP Utility window, click the  button to search for the IP devices connected in the same LAN. Click the **Name** or **Mac Address** column to sort.
3. Find the camera with its Mac Address, click on its IP address and select **Web Page**.

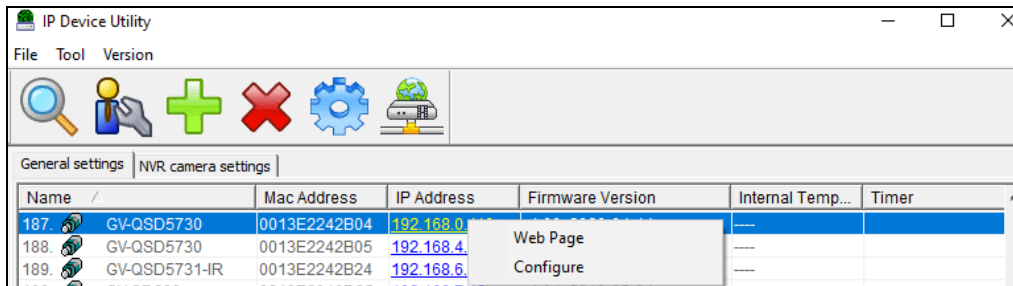

4. The prompt to create new password appears in the Web browser.

Please Change Admin Password.

Admin password

Confirm password

5. Type the desired password and click **Save**. The login page appears.



6. Type the username **admin** and your password. Click **Login**.

Note: By default, the Administrator's username is **admin** and cannot be modified.

4.3 Configuring the IP Address

By default, the GV-IP Speed Dome, connected to LAN without a DHCP server, is assigned with a static IP address of **192.168.0.10**. Follow the steps below to assign a new IP address to avoid IP conflict with other GeoVision devices.

1. Open your Web browser, and type the default IP address **192.168.0.10**.
2. For the first-time user, you will be asked to create a new password.
3. Type the username **admin** and your password. Click **Login**.
4. Click **System**, select **Network** in the left menu and select **Basic**.
5. Select **Use fixed IP address**.
6. Type the IP address, subnet mask, and default gateway address. Make sure that the IP address of the camera is unique in the network.

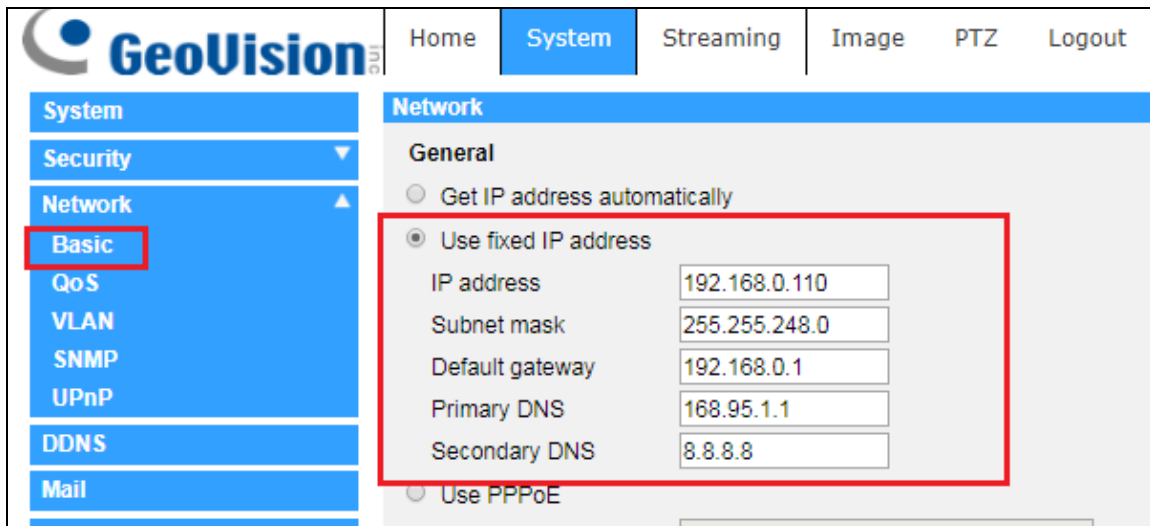

7. Click **Save**.

Note: See details in *2.2.3 Network, GV-IP Speed Dome User's Manual*.

5. The Web Interface

5.1 Viewing Live View Video

Once you log in the Web interface, you will see the live view as shown below.

Stream 1 ▼ 2016/05/11 23:39







Zoom: WIDE TELE 1x zoom x1

Focus: NEAR FAR AUTO MANUAL ZOOM

Iris: CLOSE OPEN

Stream1 H264 bitrate : 4024 kbps middle compression, middle quality
Stream2 H264 bitrate : 4024 kbps middle compression, middle quality

No.	Name	Function
1	Zoom	Adjust the camera's zoom.
2	Focus	Adjust the camera's focus.
3	Iris	Adjust the brightness of the image.
4	Control Panel	Show or hide the control panel.
5	Video Quality	Show or hide the bitrate and compression of each stream.
6	Full Screen	Display in full screen mode.
7	Talk	Turn on or off outward audio transmission.
8	Listen	Turn on or off inward audio transmission.
9	Snapshot	Click to save JPEG snapshots.

10	Live View Pause	Pause  or restart  video streaming.
11	Record	Turn on  or off  video recording.
12	Manual Trigger	Turn on  or off  the manual trigger.
<p>Note: See details in 2.1.1 Function Items on Home Page, GV-IP Speed Dome User's Manual.</p>		

5.2 PTZ Functions

You can access the PTZ functions by selecting **PTZ**.

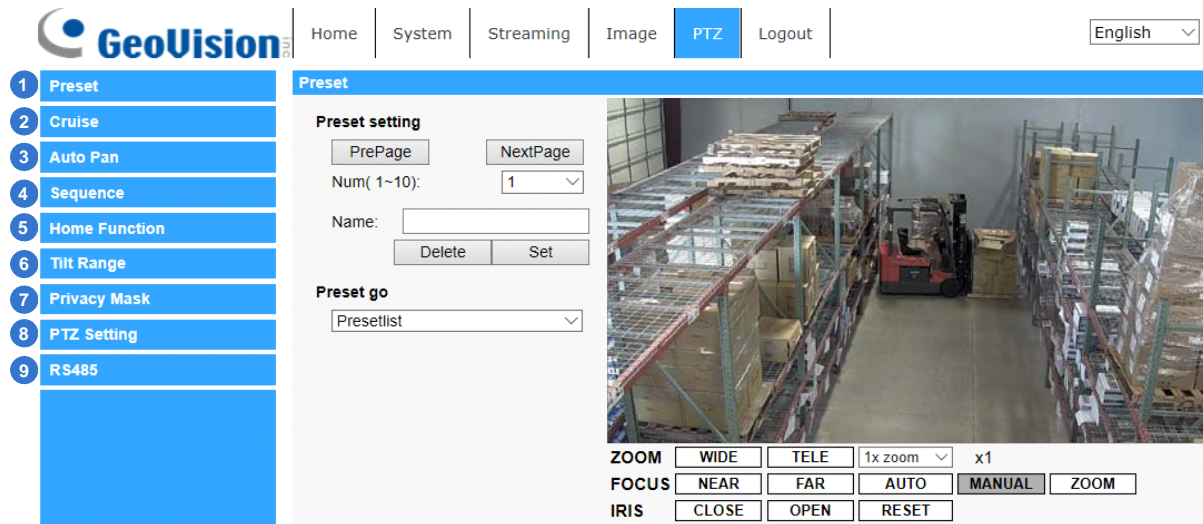

No.	Item	Function
1	Preset	Select a preset and the camera goes to the selected preset.
2	Cruise	Set cruise paths for camera touring.
3	Auto Pan	Start or stop auto panning of the camera.
4	Sequence	Set viewing sequence of the camera.
5	Home Function	Set operation modes for constant monitoring when the camera remains idle a period of time.
6	Tilt Range	Set the minimum and maximum tilt angle.
7	Privacy Mask	Set privacy masks for an intended location.
8	PTZ Setting	Configure Flip / Speed by zoom / Auto Calibration / Set Pan Zero.
9	RS485	Select the compatible protocol for connecting Joystick / Keyboard.

Note: See details in 2.5 PTZ, GV-IP Speed Dome User's Manual.

6. Upgrading System Firmware

GeoVision periodically releases the updated firmware on the [website](#). To load the new firmware into the camera, follow the instructions below.

1. Select **System** from the top menu > **Software Upgrade**. This page appears.

The screenshot shows the GeoVision web interface. The top navigation bar includes 'Home', 'System', 'Streaming', 'Image', 'PTZ', and 'Logout'. The 'System' menu is expanded, showing options like 'Software Upgrade', 'Security', 'Network', 'DDNS', 'Mail', 'FTP', 'HTTP', 'Events', 'Autotracking', and 'Storage Management'. The 'Software Upgrade' page is displayed, with the following content:

Follow These Steps To Do The Software Upgrade

Step1:
Upload the binary file

Step2:
Select binary file you want to upgrade

Step3:
Click the upgrade button to start the upgrade process

2. In Step 1, click the **Browse** button to locate the firmware file saved at your local computer.
3. In Step 2, select the type of the firmware file.
4. In Step 3, click **Upgrade**.

Note: See details in 2.2.16 Software Upgrade, GV-IP Speed Dome User's Manual.

7. Restoring to Factory Default

If for any reason the camera is not responding correctly, you can restore the camera back to its factory default settings using the Web interface or the Default Button.

7.1 Using the Web Interface

To restore to default settings using the Web interface:

1. Select **System** at the top > **Factory Default**. This page appears.

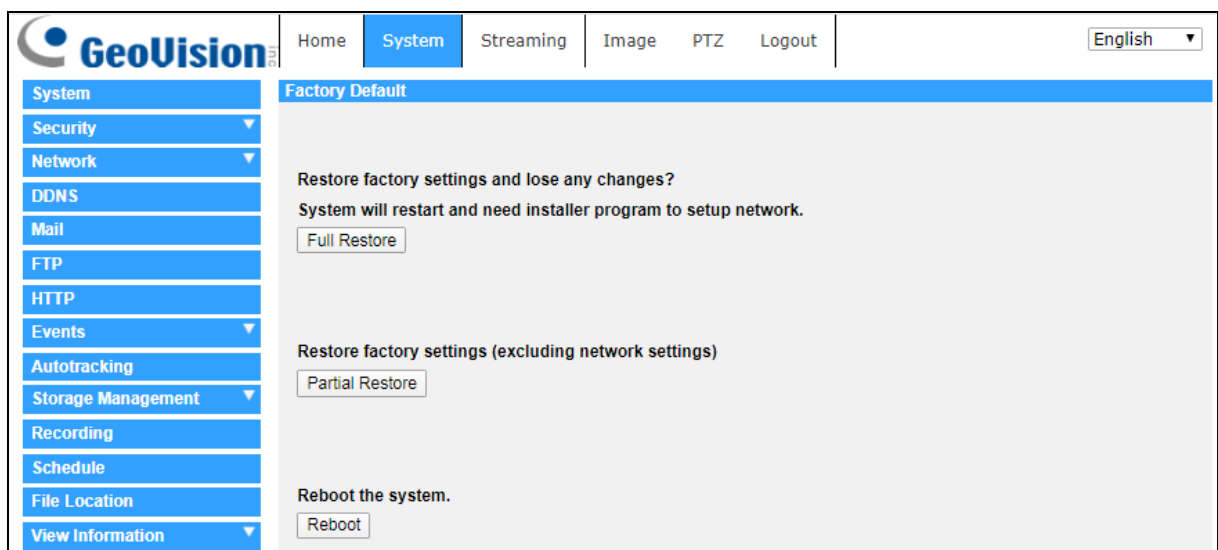

2. Select **Full Restore**, **Partial Restore**, or **Reboot**.

Note: See details in [2.2.14 Factory Default, GV-IP Speed Dome User's Manual](#).

7.2 Directly on the Camera

1. Press and hold the **Default Button** for about 20 seconds. For GV-QSD5730-Indoor, see [1.2 Overview of GV-QSD5730-Indoor](#); for GV-QSD5730-Outdoor or GV-QSD5731-IR, see [1.3 Overview of GV-QSD5730-Outdoor / GV-QSD5731-IR](#).
2. When the camera rotates twice, the process of loading default is completed and the camera reboots automatically.