

GV-EBD4813 AI 4MP H.265 5x Zoom Super Low Lux WDR Pro IR Eyeball Dome IP

Camera



- AI deep learning: AI Perimeter Protection & Classification (Human, Vehicle)
- 1/3" progressive scan super low lux CMOS sensor
- Triple streams from H.265, H.264 or MJPEG
- Wide Dynamic Range Pro (WDR Pro)
- Min. illumination at 0.002 lux
- Up to 30 fps at 2688 x 1520
- Intelligent IR
- Day and night function (with removable IR-cut filter)
- Motorized lens for remote focus/zoom adjustment
- IR distance up to 40 m (130 ft)
- Built-in microphone
- Built-in micro SD card slot (SD / SDHC / SDXC / UHS-I) for local storage
- 3-axis mechanism (pan / tilt / rotate)
- Ingress protection (IP67)
- Vandal resistance (IK10 for metal casing)
- DC 12V / PoE (IEEE 802.3af)
- ONVIF (Profile G, S, T) conformant

Introduction

GV-EBD4813 is an outdoor, network camera equipped with an automatic IR-cut filter and IR LEDs for day and night surveillance. The camera supports H.265 video codec to achieve better compression ratio while maintaining high quality pictures at reduced network bandwidths. The camera adheres to IK10 and IP67 standards, and can be powered through PoE.

Empowered by deep learning algorithms, AI technology distinguishes human and vehicles from other moving objects. Integrated with GeoVision Video Management Software (VMS), it supports AI perimeter protection, real time alert, events playback and more.

Deep Learning Function

Face Detection

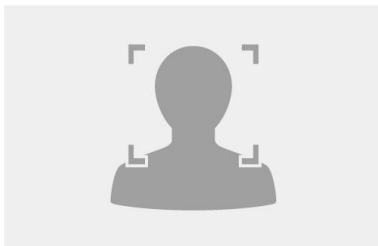

AI Perimeter Protection

(Intrusion, Crossing Line
Entering Area, Leaving Area)

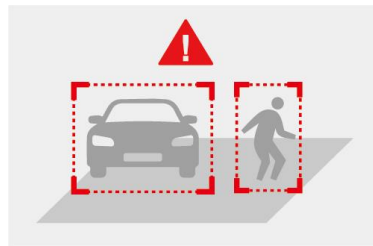

People Counting

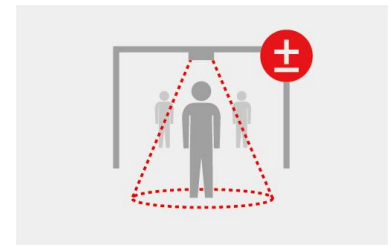

Note: The integration of AI events of the camera to GV-VMS is coming soon.

Dimensions

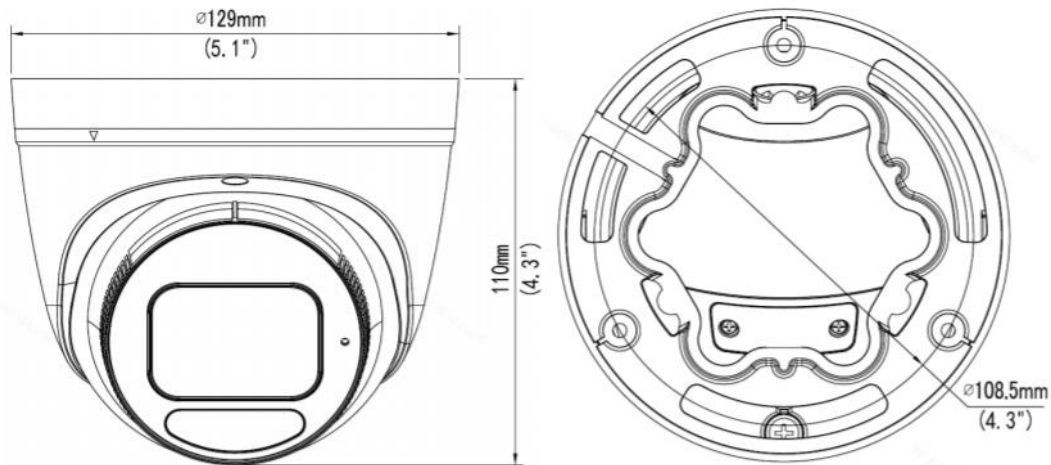

Specifications

| Camera | | |
|----------------------|-------|--|
| Image Sensor | | 1/3" progressive scan super low lux CMOS |
| Picture Elements | | 2688 (H) x 1520 (V) |
| Minimum Illumination | Color | 0.002 Lux (F1.2, AGC ON) |
| | IR ON | 0 Lux |
| Shutter Speed | | Automatic / Manual (1 ~ 1/100000 sec) |
| White Balance | | Automatic, Manual |
| Gain Control | | Automatic, Manual |
| S/N Ratio | | 56 dB |
| WDR | | WDR Pro |
| Dynamic Range | | 120 dB |

| Lens | | |
|------------------|-------|------------------------------------|
| Megapixel | | 4 MP |
| Day / Night | | Yes (with removable IR-cut filter) |
| Lens Type | | Motorized varifocal lens |
| Focal Length | | 2.7 ~ 13.5 mm |
| Maximum Aperture | | F/1.2 |
| Mount | | Ø 12 mm |
| Horizontal FOV | | 98°~31° |
| Operation | Focus | Auto / Manual |
| | Zoom | 5x Optical Zoom |
| | Iris | Fixed |
| IR LED Quantity | | 2 IR LEDs |
| Max. IR Distance | | 40 m (130 ft) |

| Operation | |
|-------------------|--|
| Video Compression | H.265, H.264, MJPEG |
| Video Streaming | Triple streams from H.265, H.264 or MJPEG |
| Frame Rate | 30 fps at 2688 x 1520, 30 fps at 2560 x 1440, 30 fps at 2304 x 1296 (60 / 50 Hz) *The frame rate and performance may vary depending on the number of connections and data bitrates (different scenes). |
| Video Analytics | Motion Detection, Tampering Alarm, Audio Detection. *Tampering alarm and Audio detection are only accessible through the camera's Web interface, which can be used to trigger alerts such as e-mail and FTP |
| Image Setting | Brightness, Contrast, Saturation, Sharpness, Flicker-less, 3D Noise Reduction, Image Orientation (Flip, Mirror, 0°, 90°, 180°, 270°-including Corridor format) |
| Audio Compression | G.711 |
| Audio Support | One-way Audio |

| Face Detection | | |
|-----------------------------------|--------------------|---|
| Environment | | 100 lux |
| Detectable face angle | Tilt (Up/Down) | ≤ 10° |
| | Swing (Left/Right) | ≤ 30° |
| Max. number of faces | | Up to 40 |
| Min. face image pixel requirement | | 80 pixels |
| Deep Learning Function | | |
| AI Analytics | | Intrusion, Crossing Line, Entering Area, Face Detection, Leaving Area (Human & Vehicle classification), People Flow Counting, Crowd Density Monitoring |
| Video Resolution | | |
| Main Stream | | 2688 x 1520 (Default), 2560 x 1440, 2304 x 1296, 1920 x 1080, 1280 x 720 |
| Sub Stream | | 1280 x 720, 720 x 576, 704 x 288, 640 x 360 (Default), 640 x 480, 352 x 288 |
| Third Stream (Closed by Default) | | 720 x 576, 704 x 288, 640 x 360, 352 x 288 |
| Network | | |
| Interface | | 10/100 Ethernet |
| Protocol | | 802.1x, ARP, DHCP, DDNS, DNS, DynDNS, FTP, HTTP, HTTPS, ICMP, IGMP, IPv4, NTP, PPPoE, Qos, RTCP, RTP, RTSP, SMTP, SNMP, TCP, UDP, UPnP, ONVIF (Profile G, S, T) |
| Mechanical | | |
| Camera Angle Adjustment | Pan | 0° ~ 360° |
| | Tilt | 0° ~ 75° |
| | Rotate | 0° ~ 360° |
| Connectors | Power | DC Jack (DC 12V, 1.25A), PoE |
| | Ethernet | RJ-45 |
| | Audio | 1 In (built-in microphone) |
| | Local Storage | Micro SD card slot (SD/SDHC/SDXC/UHS-I, Class 10) *UHS-II card type is not supported. |
| General | | |
| Environment Temperature | Start-up | -30°C ~ 60°C (-22°F ~ 140°F) |
| | Operation | |
| Humidity | | 0% ~ 95% (no condensation) |
| Power Source | | 12V DC / PoE (IEEE802.3af) |
| Max. Power Consumption | | 7.0W |
| Dimensions | | ∅ 129 x 110 mm (∅ 5.1" x 4.3") |
| Weight | | 0.69 kg (1.52 lb) |
| Ingress Protection | | IP67 |
| Vandal Resistance | | IK10 for metal casing |
| Regulatory | | CE, FCC, RoHS |
| Web Interface | | |
| Installation Management | | Web-based configuration |
| Maintenance | | Firmware upgrade through Web Browser or GV-IP Device Utility |
| Access from Web Browser | | Live View, Video Recording, Change Video Quality, Bandwidth Control, Image Snapshot, Defog, Digital Zoom, Text Overlay, Image Masking |
| Language | | Czech, English, French, German, Hungarian, Italian, Japanese, Polish, Portuguese, Russian, Spanish, Traditional Chinese |
| Applications | | |
| Software Supported | | GV-VMS (V17.4.2 / V18.2.1), GV-DVR / NVR (V8.9.1), GV-Control Center (V3.8.0), GV-Recording Server / Video Gateway (V2.0.0), GV-Edge Recording Manager Win version (V2.0.0), GV-Redundant / Failover Server (V1.2.0), GV-Mobile Server (V1.5.1) |
| Smart Device Access | | GV-Eye for iOS and Android |
| Live Viewing | | Browser (IE, Edge, Chrome, Firefox, Safari), Mobile App |









Note:

1. Patch files are required for some supported software.
2. Do not use clothes or any ordinary material to clean the camera cover since they may result in scratches.
3. Specifications are subject to change without notice.

Packing List

1. GV-EBD4813 Eyeball Dome
2. Waterproof Rubber Set
3. Screw kit
4. Drill Template Paster
5. Download Guide

Accessories

| Model No. | Name | | Details |
|---|-----------------------------------|---|--|
| GV-Mount107(must be used with GV-Mount212P) | Pendant Bracket |  | Dimensions: Ø 120 x 334 mm (Ø 4.72" x 13.15") Weight: 0.74 kg (1.63 lb) |
| GV-Mount211P | Wall Mount and Junction Box |  | Dimensions: Ø 233 x 126 x 126 mm (Ø 9.2" x 5" x 5") Weight: 1 kg (2.2 lb) |
| GV-Mount212P | Wall Box Mount |  | Dimensions: Ø 126 x 36 mm (Ø 5.0" x 1.4") Weight: 0.22 kg (0.48 lb) |
| GV-Mount300-2 | Convex Corner Mount |  | Dimensions: 137 x 233 x 160 mm (5.4" x 9.17" x 6.3") Weight: 1.65 kg (3.64 lb) |
| GV-Mount310-2 | Concave Corner Mount |  | Dimensions: 111.2 x 369.9 x 210 mm (2.6" x 11.4" x 6.6") Weight: 1.65 kg (3.64 lb) |
| GV-Mount420 (must be used with GV-Mount211P) | Pole Mount Bracket |  | Dimensions: Ø 120 x 120 x 53.4 mm (Ø 4.7" x 4.7" x 2.1") Weight: 0.45 kg (0.99 lb) Steel Strap Diameter: Ø 67 ~ 127 mm (Ø 2.6" ~ 5") |
| GV-Mount704 (must be used with GV-Mount107) | Extension Tube |  | Dimensions: Ø 3.5 x 10 or 20 or 30 or 50 cm (Ø 1.38" x 3.9" or 7.9" or 11.8" or 19.7") Weight: 225 g or 360 g or 500 g or 780 g (0.5 lb or 0.79 lb or 1.1 lb or 1.72 lb) |
| GV-PA191 | Power over Ethernet (PoE) Adapter |  | The GV-PA191 is a Power over Ethernet (PoE) adapter designed to provide power to the IP device through a single Ethernet cable. |
| GV-POE Switch | | | The GV-POE Switch is designed to provide power along with network connection for IP devices. The GV-POE Switch is available in various models with different numbers and types of ports. |
| Power Adapter | | | Contact our sales representatives for the countries and areas supported. |