

EasyLink Series

Preconfigured IP67 Wireless Bridge Kit

Application

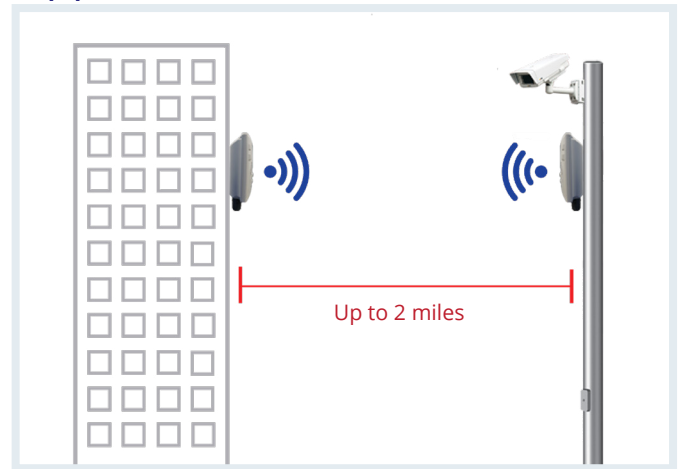

Product Highlights

➔ Easy

- Mount units to a pole or wall using included mount kit
- Signal strength LED's for easy alignment
- Just power and align using supplied PoE injectors and power supplies
- No technical expertise needed

➔ Highly Secure

- Encrypted & Authenticated Wireless Connection (WPA2)
- Every kit has unique SSID and security settings
- Management Frame Protection (MFP) Enabled

➔ Hardened-Grade for Outdoor & Harsh Environments

- Fanless and ruggedized outdoor IP67 enclosure (Rainproof)
- Wide operating temperature range (-40° to 167°F)
- Connections up to 2 miles away

➔ What's Included

- 2 x units preconfigured to connect with optimal performance up to 300Mbps
- Includes all Mounting Hardware
- Includes 2 x power supplies and 2 x PoE injectors

Overview

EtherWAN's EasyLink is a pre-configured point to point (PtP) Bridge kit which allows for connecting remote locations wirelessly up to 2 miles away. EasyLink's simple setup allows you to connect locations by mounting the hardware, powering them on and aligning the units using the built-in alignment LEDs. Each kit contains two paired units that connect automatically using a highly secure, unique, hidden SSID and randomly-generated passphrase to keep your valuable equipment secure right out of the box. No need for complicated setup software, just plug it in, aim it and you are connected.

Ordering Information

Model

EasyLink-300-US	Wireless Bridge Kit - Two paired Wireless Bridge Units, 2 x 24VDC, 1.5A Power Supplies, 2 x Passive PoE Injectors and 2 x Mounting Kits.
JPole18	18" Wall Mount J-Pole
EasyLink-PSU-INJ	Replacement Power Supply and Gigabit Passive PoE Injector for EasyLink Wireless Bridge Series
Cable 25	25' Shielded Twisted Pair CAT 6 Cable with UV Resistant Coating
Cable 50	50' Shielded Twisted Pair CAT 6 Cable with UV Resistant Coating
Cable 150	150' Shielded Twisted Pair CAT 6 Cable with UV Resistant Coating
Cable 300	300' Shielded Twisted Pair CAT 6 Cable with UV Resistant Coating
PWR-H	Hardened Power Supply rated for use in temperatures -40°F to 165°F
PoEPowerEZ	PoE Switch to EasyLink Adapter Hardened -40°F to 165°F (Eliminates the need for a power supply)

2 x Paired Easylink Units, 2 x Wall Power Supplies, 2 x PoE Injectors, 2 x Pole Mounting kit, 2 x Wall Mounting Poles, Quick Install Guide (see picture at top)

Hardware Specifications

Wireless +	
Frequency 5 GHz	
Max data rate 300 Mbit/s	
Number of chains: 2	
Standards 802.11a/n	
WPA2 Passphrase	
256-bit AES-CCM Encryption	
Dynamic Frequency selection	
Layer 2 Features +	
Auto-negotiation for port speed and duplex	
Redundant Protocols (always enabled)	IEEE 802.1D Spanning Tree Protocol (STP) IEEE 802.1w Rapid Spanning Tree Protocol (RSTP) IEEE 802.1s Multiple Spanning Tree Protocol (MSTP)
Interface +	
Ethernet	10/100/1000BASE-T Passive PoE
Wireless	802.11a/n
LED Indicators	
 <p>The LED indicator panel contains four indicators: 'System On' (a single green dot), 'Link Activity' (a green dot with a pulse), and 'Signal Strength' (three green dots with increasing concentric arcs representing signal strength).</p>	
Technology +	
Standards	IEEE 802.3 10BASE-T IEEE 802.3u 100BASE-T IEEE 802.3ab 1000BASE-T IEEE 802.3x full duplex and flow control IEEE 802.1D STP IEEE 802.1s MSTP IEEE 802.1w RSTP IEEE 802.11w Management Frame Protection (MFP)
Power	PoE in (Passive PoE) PoE in input Voltage 6-30V Max power consumption 10W
Physical +	
Casing Material	UV Protected Polystyrene case
Dimensions	185 x 185 x 63.5mm (W x D x H) 7.28" x 7.28" x 2.5"
Weight (shipping)	5.3lbs (2.4kg)
Installation Type	Pole/Wall

Environmental +	
Operating Temp.	-40 to 75°C (-40 to 167°F)
Storage Temp.	-45 to 85°C (-49 to 185°F)
Relative Humidity	5% to 95% (non-condensing)
Wind Survivability	200km/h
*Power supply rated 5°F to 158°F	
Regulatory +	
ISO	Manufactured in ISO-9001 facility
EMI	FCC Part 15B Class A PCC Part 15C
Environmental Test Compliance +	
IEC 60068-2-6 Fc (Vibration Resistance)	
EN 61000-4-3 (Radiated RFI)	
Warranty +	
Length	3 Years
Details	https://etherwan.com/support/warranty-policy

Dimensions

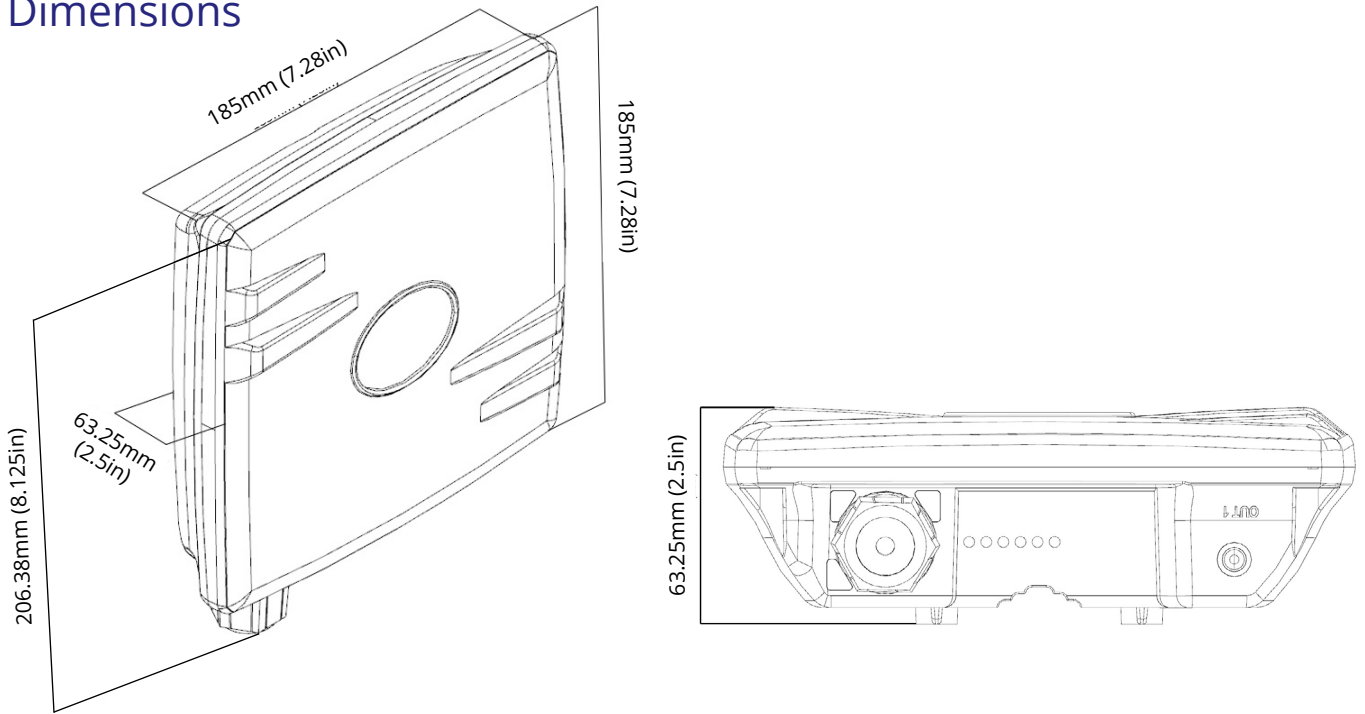

Unit Connected

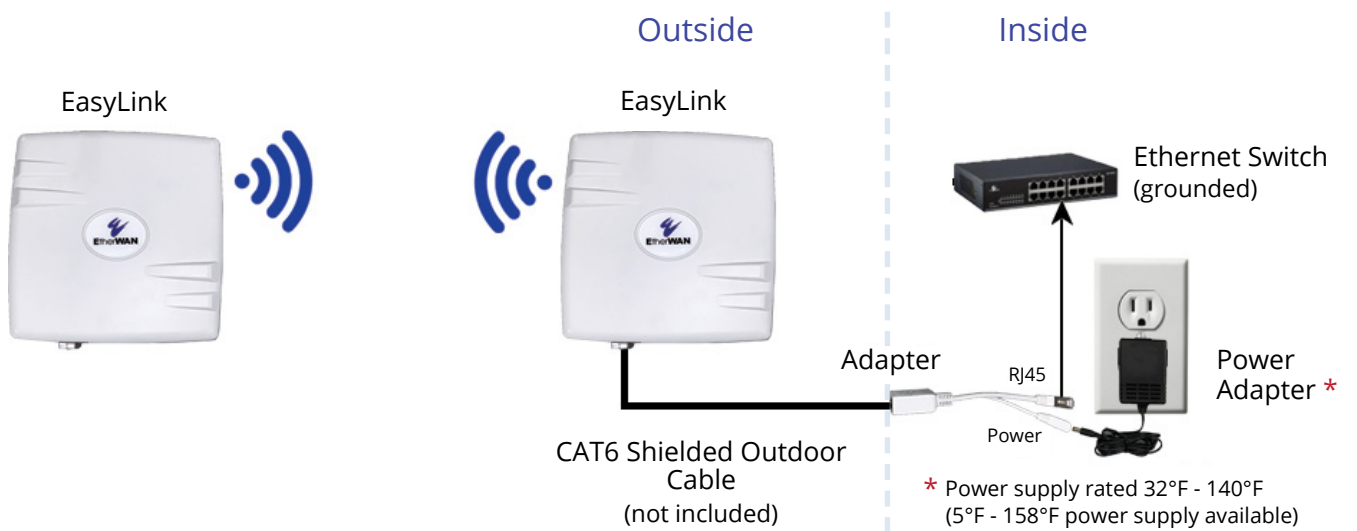

Unit Mounted

Wall Mounted

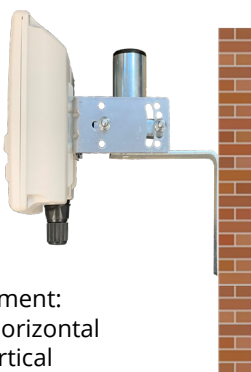

Adjustment:
180° Horizontal
30° Vertical

(Wall mount screws and anchors not included)

Pole Mounted



0.25" - 2.0" OD pole supported

Side View

Back View

Antenna Specifications

Performance		+
VSWR	< 2.0 @ 5 - 5.9 GHz	
Dual polarized	Horizontal & Vertical	
High gain	Up to 13 dBi	
Front to Back Ratio	> 20dB	
Port isolation	> 30dB	

Electrical Specification		+
Frequency Range	5 - 5.9 GHz	
Gain	13 dBi typ.	
Polarization	Dual linear - V & H	
Beamwidth Horizontal	37 deg @ -3dB	
Beamwidth Vertical	37 deg @ -3dB	
VSWR	< 2.0 typ.	
Impedance	50 Ohm	
RF Interface	2 x SMA Female	
Front-to-Back Ratio	> 20 dB	
Port-to-Port Isolation	> 30 dB	

Gain — Azimuth & Elevation — Port 1

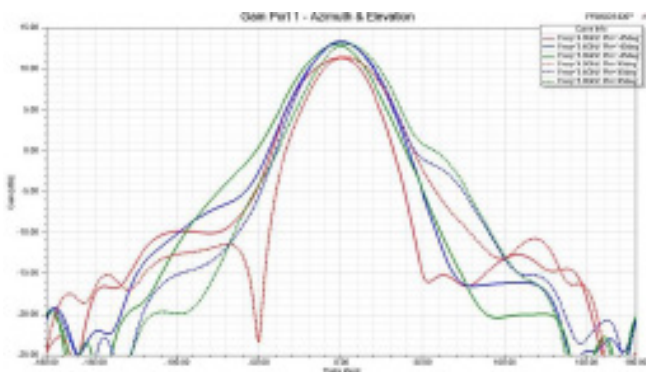

Gain — Azimuth & Elevation — Port 2

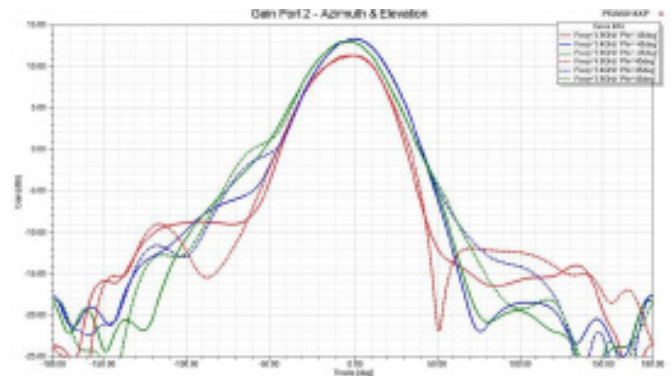

3D Gain — Port 1

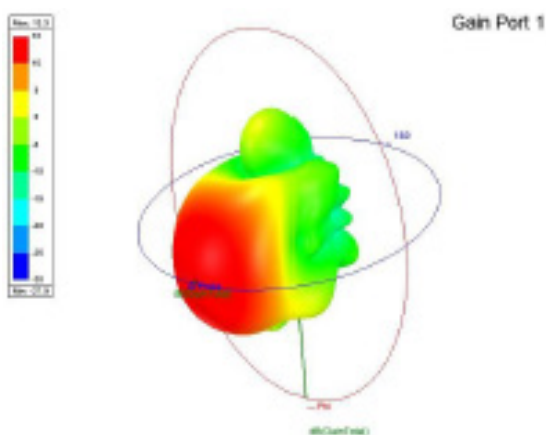

3D Gain — Port 2

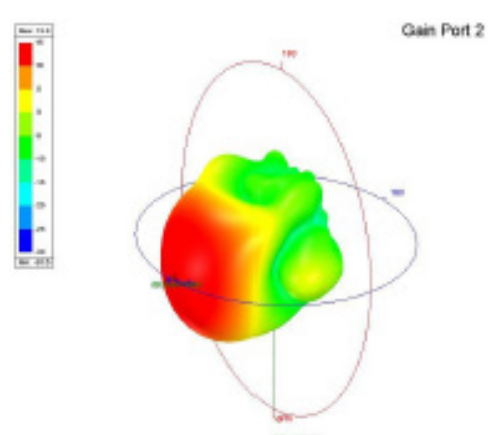

Note:

The EasyLink is a cost-effective Wireless Bridge solution. For successful deployment a couple of factors should be taken into consideration.

1. If one of more ends of the connection do not have access to a temperature controlled area within 350ft. for powering the unit, it is advised to purchase the optional hardened power supply.
2. When mounted outdoors it is required to use UV rated shielded twisted pair CAT 6 cabling. This helps protect against surges due to electrical storms. Be sure the network side of the shielded cable is grounded either through the switch or receptacle. Optional grounded ethernet switches are available from EtherWAN for purchase.