

# SUPPLEMENTAL INSTRUCTIONS

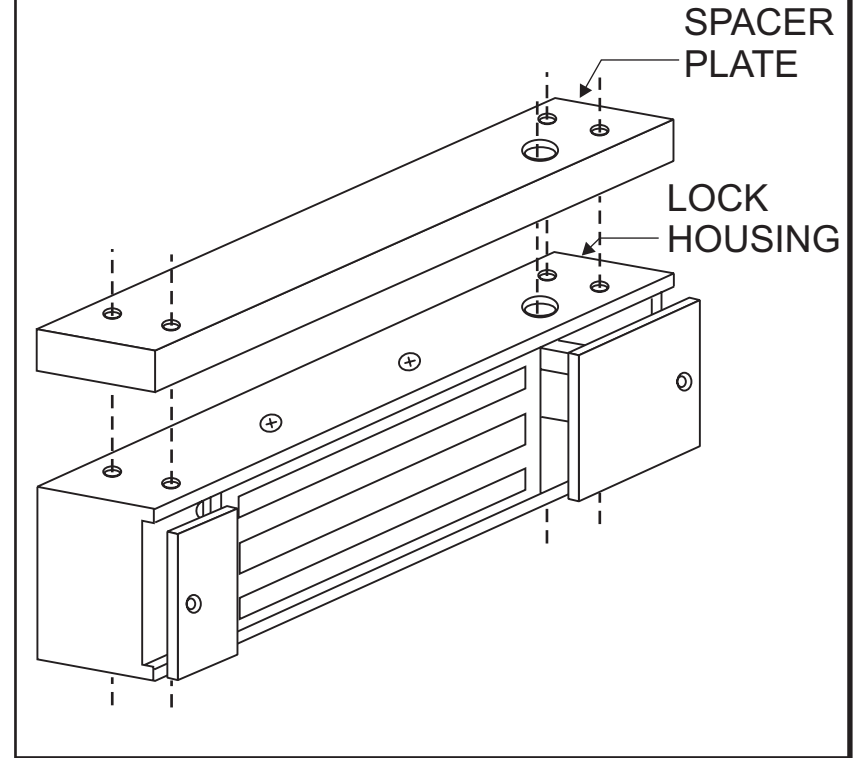
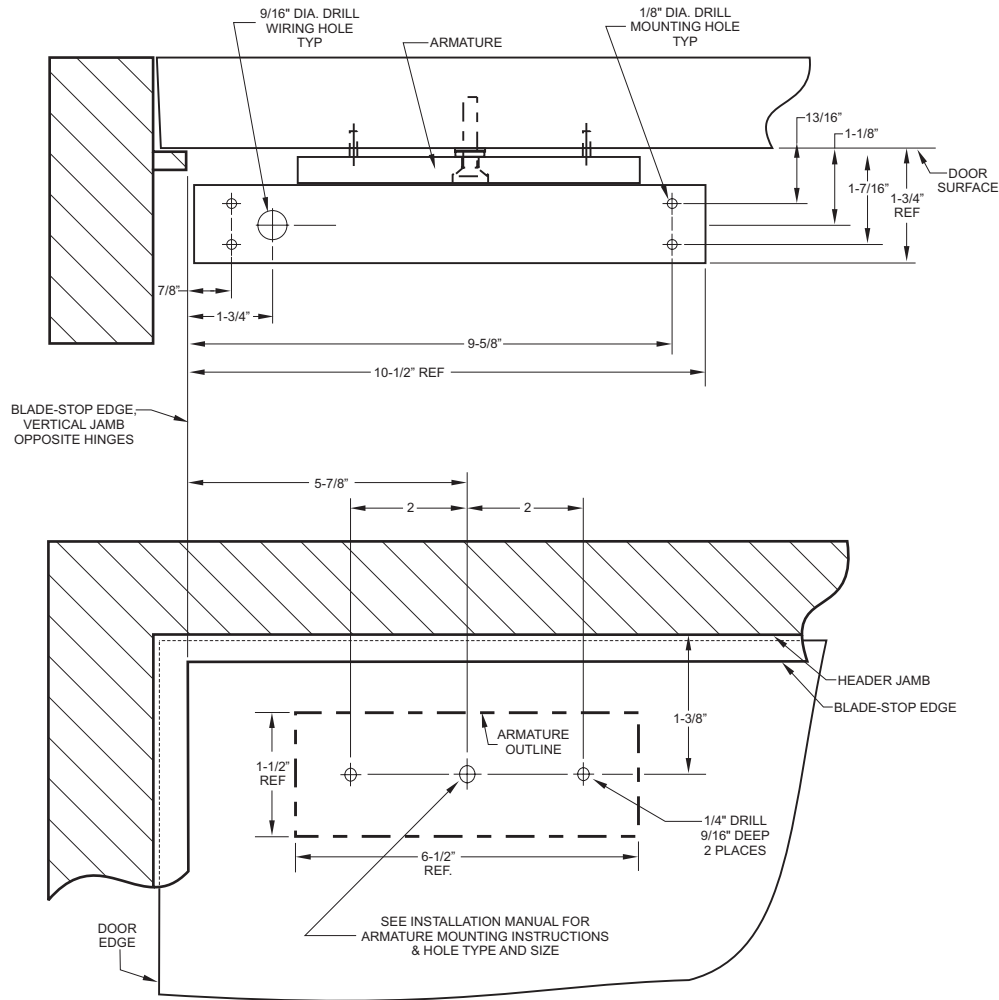

DynaLock Corporation  
 705 Emmett Street • Bristol, CT 06010  
 Tel: (860) 582-4761 • Fax: (860) 585-0338

Template Drawing

DRWN: MJL Date: 11/28/05  
 CHK'D: JAS Date: 12/01/05  
 APPV'D: Date:

Title: TEMPLATE DRAWING FOR 2511 SERIES USING MODEL #4302 SPACER PLATE

Page	Scale:	Size:	Drawing #:	REV:
1 Of 1	—	A	301226	