

**1.0 Description**

The DS150i is a passive-infrared detector designed for request to exit (REX) applications. It is UL Listed as an access control device under the UL 294 standard and is listed for Class I for UL Canada (ULC-S319). For C-UL listed installation applications, the REX shall be connected to ULC-S319 listed compatible devices (i.e. control units, power supply and locks). Intended for indoor use only.

The relay output consists of two Form "C" contacts that can be adjusted to latch from approximately 0.5 sec to 64 sec. The latch time features two modes of operation: resettable (R) and non-resettable (NR). The relay can also be programmed to fail safe or fail secure during a power loss.

You can mount the DS150i on the ceiling or wall and aim and/or mask its pattern for more effective use based on installation needs. The DS150i is not designed as the primary means of exit for emergency egress applications.

The DS150i is available in a light grey (DS150i) or a black (DS151i) enclosure. An optional trimplate is also available in light grey (TP160) and black (TP161).

**2.0 Mounting**

1. Select a mounting location over the center of the door or doors to be covered. **The target must walk directly toward the detector.** Mount the detector on the ceiling, wall, or door frame. The detector can be surface mounted or mounted to a keyswitch plate with a "D" size hole.

The DS150i is not tall enough to completely cover a single gang box. Where aesthetics are important, mount it using the optional trimplate (TP160 or TP161). Refer to *Figure 1* for additional instructions for mounting with the trimplate.

**Figure 1: Optional Trimplate**

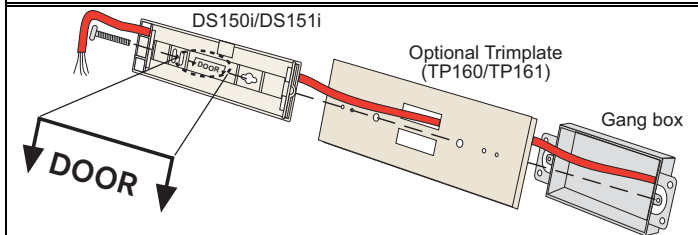

The arrows on the base indicate its correct mounting orientation relative to the door.

The mounting height range is from 7 ft to 15 ft. (2.1 m to 4.6 m) above the floor.

2. Remove the back cover from the detector. Insert the head of a small straight edge screwdriver into the locking tab and pry the back cover off.

When the back cover is removed, the front cover and detector module separate.

3. Route the wiring as necessary through the wiring entrance (refer to *Figure 2*). For surface wiring, use the break out wiring entrance on the front cover (at the same end as the wire entrance).
4. Loosely mount the back cover to the mounting surface using the supplied mounting screws.
5. Mount the detector module to the back cover. Aim the detector for the desired coverage.

Coil excess wiring behind the back cover along the channels provided.

**Figure 2: Location of Major Items**

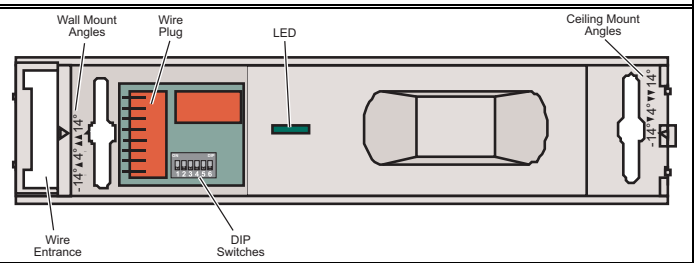

**3.0 Wiring**

**3.1 General Information**

Only apply power after all connections are made and inspected. Remove all system power (AC and standby battery) before wiring the device.

Attach the wiring connector (provided) to the wire plug on the circuit board (refer to *Figure 3*).

**Figure 3: Connector to Plug Orientation (Default Switch Settings)**

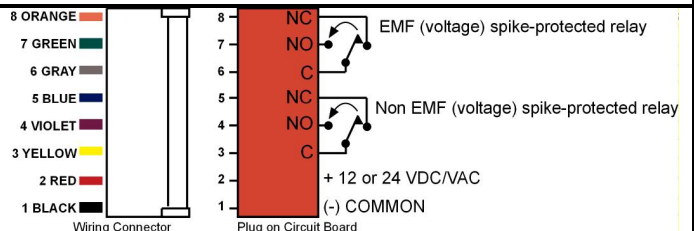

Refer to *Figure 4* to wire the detector's relay contacts.

**Figure 4: Relay Contact Wiring**

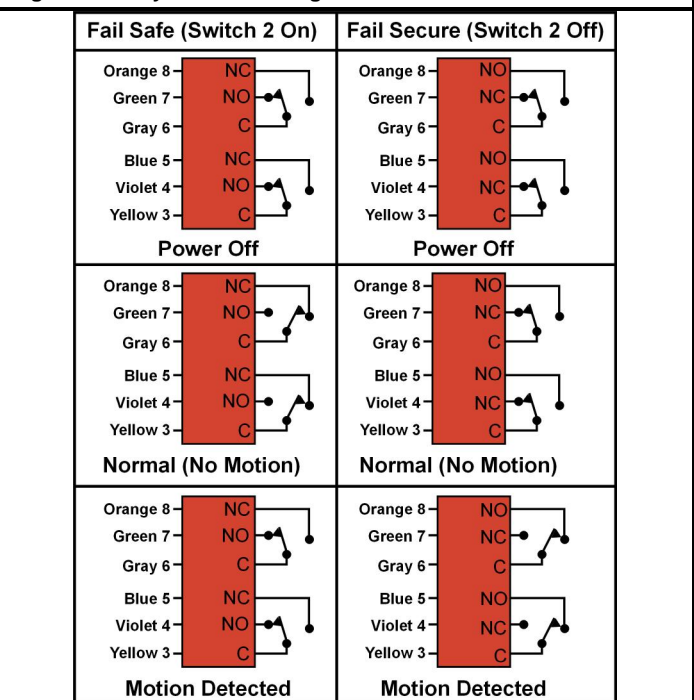

### 3.2 EMF (Voltage) Spike-Protected Relay

Pins 6 through 8 (wire colors gray, green, and orange) comprise the EMF spike-protected relay. Refer to *Figure 3*.

Use this relay when connecting inductive loads to the detector. This relay protects the detector from inductive loads that might deliver damaging EMF spikes.

### 3.3 Non-EMF (Voltage) Spike-Protected Relay

Pins 3 through 5 (wire colors yellow, violet, and blue) comprise the non-EMF spike-protected relay. Refer to *Figure 3*.

This relay is best used for non-inductive loads. When connecting an inductive load that is not spike-protected, such as a magnetic door lock, to the detector, use either a bridge rectifier (such as a KBL01) or a diode (such as a 1N4007). Failure to use a bridge rectifier/diode may reduce the lifetime of the relay. Refer to *Figure 5*.

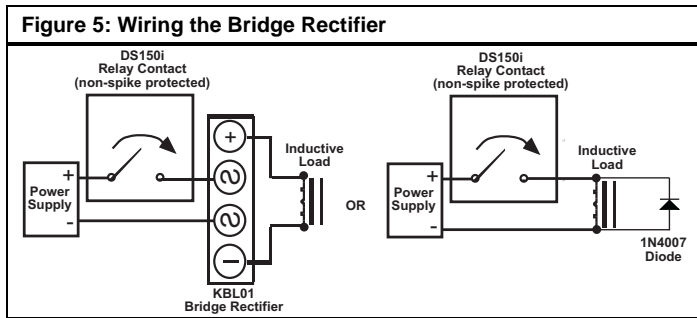

**i** UL 1034 listed magnetic locks typically are already EMF spike-protected, and therefore do not require the bridge rectifier or diode as shown in *Figure 5*. Adding a bridge rectifier/diode to an EMF spike-protected device can cause unwanted delays in response. Refer to the magnetic lock's documentation for more information.

### 4.0 Configuration

Use the on-board DIP switches to configure the operation of the detector. Refer to *Figure 6* for proper switch positioning.

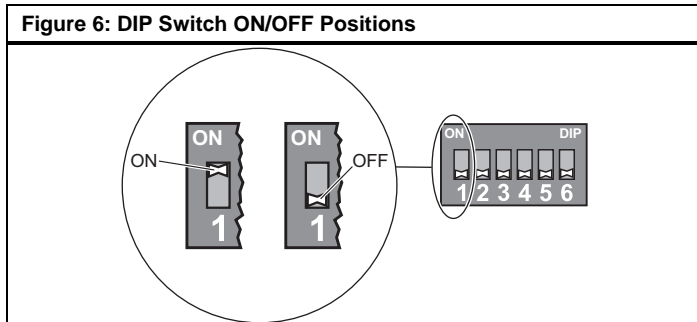

#### 4.1 Resettable/Non-resettable Timer Selection

DIP Switch 1 determines if the relay resets at the end of latch time, or if latch time is extended by additional motion. Refer to *Table 1* and *Figure 6* for more information.

- **Resettable:** The relay activates when the detector first sees motion. Any additional motion restarts the latch timer so the relay deactivates only when the detector no longer sees motion and the latch time has expired. **Hint:** This setting works best when bypassing a 24-hour contact.
- **Non-resettable:** The relay activates when the detector first sees motion. It deactivates when the latch time ends, even if motion is still present. **Hint:** This setting works best when used with an access control system.

Switch 1	Function
OFF	Non-resettable
ON	Resettable ( <b>Default</b> )

#### 4.2 Relay Mode

DIP Switch 2 selects the relay mode. This allows you to select a fail safe by default, or a fail secure mode. Refer to *Table 2* and *Figure 6* for more information.

- **Fail Safe:** In the event of a power loss, the REX detector releases the device connected to it (for example, magnetic door lock or electric door strike).
- **Fail Secure:** In the event of a power loss, the REX detector does not release the device connected to it (for example, magnetic door lock or electric door strike).

In Fail Secure mode, the REX detector shall be installed in a manner that does not impair the intended operation of panic hardware used in conjunction with the REX detector.

Failure Secure mode must be authorized by the local Authority Having Jurisdiction (AHJ).

Switch 2	Function
OFF	Fail Secure
ON	Fail Safe ( <b>Default</b> )

Refer to *Figure 4* relay wiring options.

#### 4.3 Led Enable/Disable

DIP Switch 3 selects whether the on-board LED is enabled or disabled. If enabled, the LED operates normally when motion is detected.

Switch 3	Function
OFF	Disabled
ON	Enabled ( <b>Default</b> )

**i** When LED is enabled, it will flash on and off when first powered up. Once the flashing LED stops, the REX is ready to be used.

#### 4.4 Latch Time

DIP Switches 4, 5, and 6 set the relay latch time. Latch time is adjustable from 0.5 sec to 64 sec. It indicates the amount of time the relay can remain active after the detector first sees motion.

Time (sec)	Switch 4	Switch 5	Switch 6
0.5 (Default)	OFF	OFF	OFF
1	OFF	OFF	ON
2	OFF	ON	OFF
4	OFF	ON	ON
8	ON	OFF	OFF
16	ON	OFF	ON
32	ON	ON	OFF
64	ON	ON	ON

## 5.0 Setup and Testing

1. Apply power to the unit.
2. Wait at least 3 min for the detector to settle.
3. Test the unit by walking directly through the coverage area, toward the door.
4. Aim the detector up or down if necessary to obtain the proper coverage. Tighten the screws after aiming the detector.
5. Check that the relay latch time is sufficient. Adjust if necessary.
6. After confirming proper operation, replace the cover and walk test one more time to ensure the coverage has not changed.

## 6.0 Other Information

- **Single Door Use:** The pattern can be masked to remove the outer zones using the supplied masking kit. Snap the masking wedges into place on the outer surface of the lens (refer to *Figure 7*). The masking wedges eliminate zones A, B, K, and L.

**Figure 7: Pattern Masking**

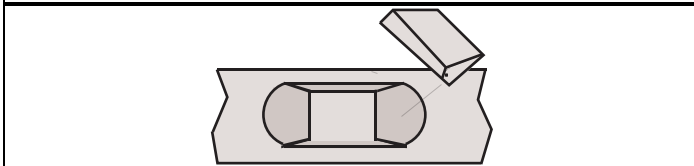

- **Testing:** Test the detector a minimum of once each year to ensure continued operation.

## 7.0 Coverage

Figure 8 and Figure 9 show the standard patterns for a wall-mounted unit.

**Figure 8: Standard Patterns for a Wall-mounted Unit**

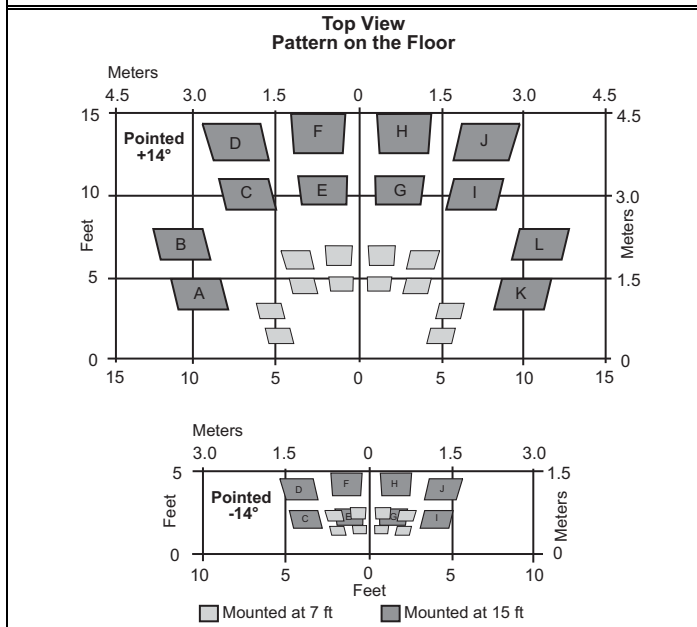

**Figure 9: Standard Patterns for a Wall-mounted Unit**

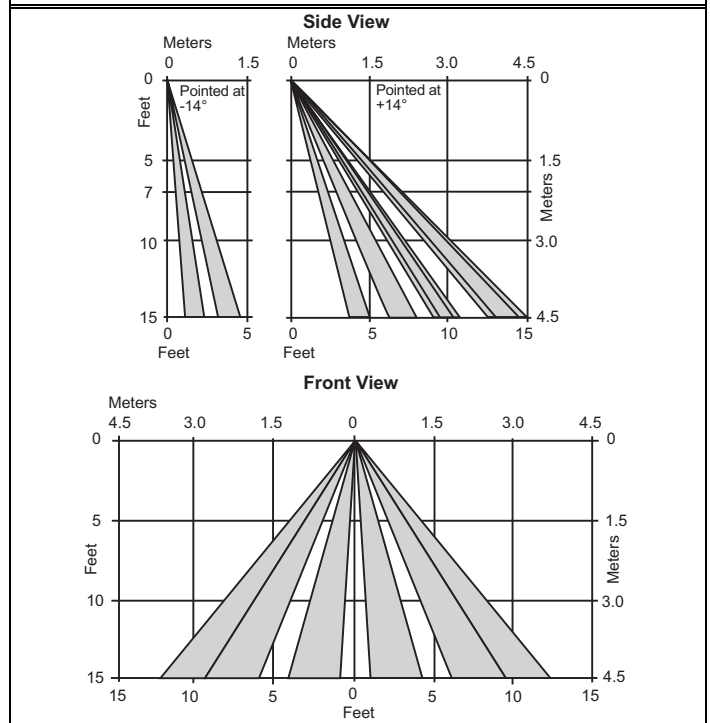

## 8.0 Application Notes

### 8.1 General

Double entry/exit doors **without** a center post present a problem resulting from a gap that might exist between doors. While the gap is usually filled with soft or pliable weather stripping, there is an opening that vandals can use to insert an object (such as a comb or ruler) through and into the coverage pattern of the detector. If the object is a different temperature from the background, the DS150i interprets the temperature change as a request to exit. Install a DS150i over the center of double doors **with** a center post.

When there is no center post, consider an alternative mounting option to move the center of the pattern away from the gap.

### 8.2 Ceiling Mount

Mount the DS150i to the ceiling and away from the door. Longer objects can still be used to enter the coverage pattern. This type of entry would now be much more difficult.

### 8.3 Dual Mount

Install and center one DS150i over each of the two doors and wire the outputs so either detector permits exiting. Reduce the probability of interference from foreign objects by masking out the **inside** zones (K & L on one detector, A & B on the other detector). Refer to *Figure 10*.

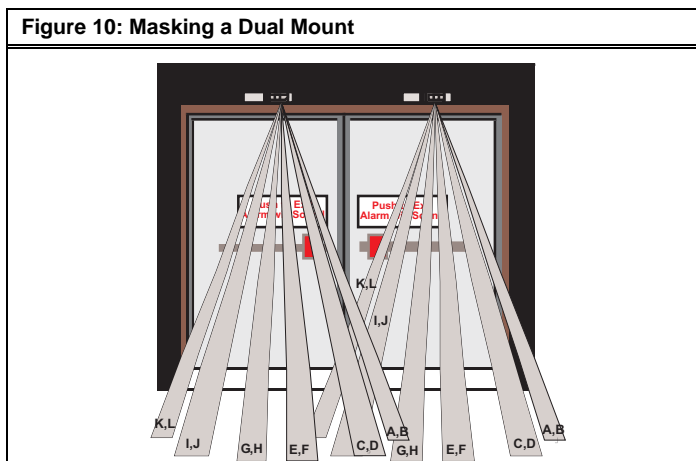

### 8.4 Regulatory Notes

The unit shall be installed in accordance with National Electrical Code ANSI/NFPA 70 and part 1 of the Canadian Electrical Code CSA C22.1, Safety Standard for Electrical Installations.

The Request-to-Exit detector was tested for UL compliance while powered by an XF 1640EE transformer made by AmSeco.

## 9.0 Install and center one Specifications

Input Power	12 or 24 VDC: 35 mA at 12 VDC when in alarm 38 mA at 24 VDC when in alarm 12 or 24 VAC: 42 mA at 12 VAC when in alarm 48 mA at 24 VAC when in alarm
Standby Power	There is no internal standby battery. Provide 38 mAh for each hour of standby time required.
Relay	Two Form "C" contact sets rated 2.0 A at 30 VDC or VAC maximum for DC resistive loads.
Temperature	-20°F to +120°F (-29°C to +49°C). For UL and C-UL certified installations, the temperature range is +32°F to +120°F (0°C to +49°C.)
Humidity	0-95% non-condensing
Enclosure (HxWxD)	1.50 in. x 6.25 in. x 1.50 in. (3.8 cm x 15.8 cm x 3.8 cm)

## 10.0 Reading Bosch Security Systems, Inc. Product Date Codes

For Product Date Code Information, refer to the Bosch Security Systems, Inc. Web site at: <http://www.boschsecurity.com/datecodes>.

