

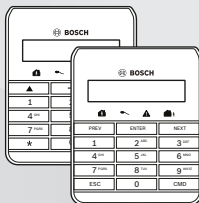

BOSCH

Control Panels

B9512G/B8512G/B6512/B5512/B4512/B3512

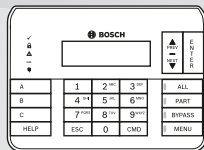
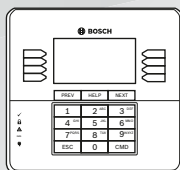
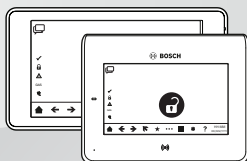

en Operation Manual

Table of contents

1	Introduction	8
1.1	About documentation	8
2	Keypads overview	10
2.1	Identify your keypad style	10
2.2	Keypad cleaning	11
3	Points	12
3.1	What is a point?	12
3.2	Controlled points	12
3.3	24-hour points	13
4	Areas	14
4.1	What is an area?	14
5	Warning displays and tones	15
5.1	Keypad quiets for keystrokes	15
5.2	Silence the alarm tone	15
5.3	Entry delay tone and display	15
5.4	Exit delay tone and display	16
5.5	Keypress tones	16
6	How the system reports events	17
7	Alarm events	19
7.1	Priority of events	19
7.2	Fire alarms	19
7.3	Gas alarms	21
7.4	User and burglary alarms	22
8	Trouble events	23
8.1	Fire trouble events	23
8.2	Gas trouble events	23
8.3	User and burglary trouble events	23
8.4	System trouble events	24

9	Cleared events are not lost	25
10	View faulted or bypassed points	26
11	B94x Keypad operation overview	28
11.1	Main display area	30
11.2	Ribbon bar overview	34
11.3	Status indicators overview	35
11.4	Feature key	37
12	B93x keypad operation overview	38
12.1	Keys overview	40
12.2	Display overview	42
12.3	Status indicators overview	43
13	B94x/B93x menu tree and commands	45
14	B94x/B93x On/Off menu	51
14.1	All On menu	51
14.2	Part On menu	55
14.3	Off menu	58
14.4	Extend Closing	61
14.5	Bypass	63
15	B94x/B93x Status menu	65
15.1	View Area Status	65
15.2	View Point Status	66
15.3	Send Status Report	67
16	B94x/B93x Actions menu	68
16.1	Reset	68
16.2	Outputs	69
16.3	Test	69
16.4	RPS	75
16.5	Go to area	78
16.6	Firmware	79
16.7	Service bypass	79

16.8	Access menu	79
17	B94x/B93x Users menu	85
17.1	Change Passcode	85
17.2	Add User	87
17.3	Edit User	94
17.4	Delete User	98
18	B94x/B93x Settings menu	99
18.1	Watch Mode	99
18.2	Date/Time	101
18.3	Schedule (SKEDs)	102
18.4	Keypad	104
19	B94x/B93x Shortcuts menu	109
20	B94x/B93x Events menu	110
20.1	View Event Memory	110
20.2	Clear Event Memory	111
20.3	View Log	112
21	B92x keypad operation overview	114
21.1	Keys overview	116
21.2	Display overview	118
21.3	Status indicators overview	119
22	B91x Keypad operation overview	121
22.1	Keys overview	123
22.2	Display overview	124
22.3	Status indicators overview	124
23	B92x/B91x menu tree	126
24	B92x/B91x On/Off menu	132
24.1	All On menu	132
24.2	Part On menu	136
24.3	Off menu	139
24.4	Extend Closing	141

24.5	Bypass menu	143
25	B92x/B91x Status menu	145
25.1	View Area Status	145
25.2	View Point Status	146
25.3	Send Status Report	147
26	B92x/B91x Actions menu	148
26.1	Reset	148
26.2	Outputs	149
26.3	Test	149
26.4	RPS	155
26.5	Go to Area	157
26.6	Firmware	159
26.7	Service Bypass	160
26.8	Access menu	160
27	B92x/B91x Users menu	166
27.1	Change Passcode	166
27.2	Add User	168
27.3	Edit User	174
27.4	Delete User	178
28	B92x/B91x Settings menu	179
28.1	Watch Mode	179
28.2	Date/Time	181
28.3	Schedule (SKEDs)	183
28.4	Keypad	185
29	B92x/B91x Shortcuts menu	189
30	B92x/B91x Events menu	190
30.1	View Event Memory	190
30.2	Clear Event Memory	191
30.3	View Log	192
31	D1260/D1255 keypads	193

31.1	D1260 Series keypad overview	193
31.2	D1255 Series keypad overview	194
31.3	Operation overview	195
32	Options	198
32.1	Two-man Rule	198
32.2	Early Ambush	199
32.3	Security system limitations	201
32.4	Cross points	203
32.5	Fire safety and evacuation	204
32.6	Multiple area systems	206
	Glossary	214

1 Introduction

Security systems help to secure life, property, and investments against fire, theft, and bodily harm. The keypad is an advanced digital device that offers a variety of features not available with other systems. Its highly visible, back-lit display and built-in sounder alert you to a number of system events. Stylish design and ease-of-use make it ideal for property protection.

Your security company can program the system to meet your individual needs. Your property is given its own English language description that appears in the display. Contact your security company should problems be encountered during testing of the system.

Your alarm company is:

Call before test: _____

1.1 About documentation

This owner's manual covers basic and advanced functions. This manual is designed as an everyday reference for system users. The functions described in this manual are programmed by your security company. Your system might not include all of the functions described. Some functions require you to enter your personal passcode.

Manual organization

- Section 2. Helps you identify your keypad style.
- Sections 3 through 10. Examines security system basics.
- Sections 11 through 20. Covers how to use B94x/B93x keypads.
- Sections 21 through 30. Covers how to use B92x/B91x keypads.
- Section 31. Covers how to use D1260x/D1255x keypads (B9512G/B8512G control panels only).
- Section 32. Explains optional features and security system recommendations and limitations.

Manual conventions

Throughout this manual, the # symbol refers to a variable numerical quantity, such as the number of points to test or exit delay time.

Text that shows on the keypad's display appears in this manual in *italics*. Text that appears in this manual in brackets [] instructs you to press the corresponding icon/key on your keypad.

Copyright

This document is the intellectual property of Bosch Security Systems, Inc. and is protected by copyright. All rights reserved.

Trademarks

All hardware and software product names used in this document are likely to be registered trademarks and must be treated accordingly.

2 Keypads overview

2.1 Identify your keypad style

- ▶ Identify your keypad so that you can read the appropriate instructions.

B94x

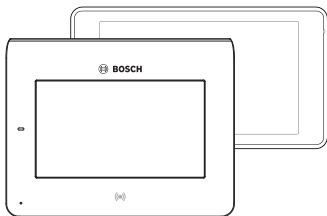

B93x

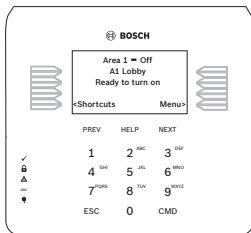

B92x

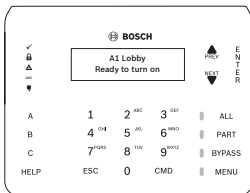

B91x

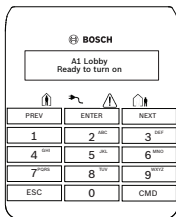

D1260x

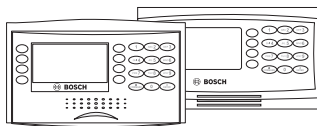

D1255x

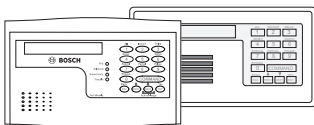

2.2 Keypad cleaning

Use a soft cloth and non-abrasive cleaning solution to clean your keypad (for example, microfiber cloth and eyeglass cleaner). Spray the cleaner onto the cloth. Do not spray directly onto the keypad.

3 Points

3.1 What is a point?

The term point refers to a detection device, or group of devices connected to your security system. Points show individually at the keypad with their names. The point name can describe a single door, motion sensor, smoke detector, or an area such as Upstairs or Garage. There are two basic types of points, controlled and 24-hour.

3.2 Controlled points

Controlled points respond to alarm conditions depending upon whether the system is turned on (armed) or turned off (disarmed). Controlled points are programmed to respond instantly to alarm conditions or to provide a delay for you to reach the keypad and turn your system off. There are two types of controlled points, part points and interior points.

3.2.1 Part points

Part points often include the exterior doors and windows of the building (the perimeter). When you turn your system Part On, you only turn on (arm) the part points.

3.2.2 Interior points

These points often include interior forms of burglary detection devices, such as motion sensors or interior doors. When you turn your system All On, you turn on (arm) both part points and interior points.

3.3 24-hour points

24-hour points are always on (armed), even when your security system is turned off (disarmed). There are two types of 24-hour points, fire points and non-fire points.

3.3.1 Fire points

Fire points exclusively monitor fire detection devices. They are always on (armed) and cannot be turned off (disarmed). You can clearly distinguish fire points from other non-fire points at the keypad.

3.3.2 Non-Fire points

Non-fire 24-hour points are always on (armed) and you cannot turn them off (disarm). Panic buttons, hold up buttons, low temperature sensors, and water sensors are examples of devices that are typically monitored by non-fire 24-hour points.

4 **Areas**

4.1 **What is an area?**

An area is a number of points that are grouped together so that you can control them together as one unit. For example, if a security system protected a building with three sections – an office, a laboratory, and a cafeteria – the points in each of those sections could be grouped together as an area. With each section being its own area in your security system, you can turn them on (arm) and off (disarm) individually, in groups (office and laboratory, for example), or all together.

5 Warning displays and tones

The keypad emits several distinct tones and shows text to alert you to system events. Additional bells or sirens may also be connected to your system. Bells or sirens mounted on the exterior of the premises alert neighbors to emergencies and provide an audible guide for police and fire fighters.

The keypad has status icons that show the status of the system. For more information, refer to the status icons overview section.

5.1 Keypad quiets for keystrokes

Pressing any key on the keypad lights the keys and quiets any warning tones. If you do not press another key within 20 seconds, the keypad lights go out and the warning tones resume.

5.2 Silence the alarm tone

The audible alarm sounds for a specific period of time before it automatically shuts off. To silence the alarm before the time expires, simply enter your personal passcode and press **ENTER**.

5.3 Entry delay tone and display

When you enter a system that is on (armed) through a point programmed for entry delay, the keypad emits the entry delay tone as a reminder to turn off the security system.

Failure to turn off your security system before the entry delay time expires might sound the burglary tone and could result in an alarm report being sent to your security company.

Your security company programmed the entry delay times for you:

My entry delay time is: _____

5.4 Exit delay tone and display

When you first turn on (arm) your system (using your keypad or keyfob), the keypad emits the exit delay tone, shows *Exit Now!*, and counts down the exit delay time. The tone pulsing rate increases during the last 10 sec of exit time.

If you exit and re-enter before exit time expires, the exit delay timer restarts the countdown. The restart only applies once.

Your security company programmed the exit delay times for you:

My exit delay time is: _____

5.5 Keypress tones

The keypad sounds the keypress tone (a short beep) when you press any key. Use the Settings menu to enable/disable the keypress tone.

5.5.1 Invalid entry (error tone)

The invalid entry tone follows the keypress tone when the keypress completes an invalid entry.

Some entries require one keypress. Other entries require a series of two or more keypresses.

6 How the system reports events

Your security system makes repeated attempts to send reports to your security company. In the event your security system fails to communicate, the keypad sounds the trouble tone and the keypad shows a communication failed message. Notify your security company of the communications failure.

If your telephone, internet, or cellular service is interrupted, your security system cannot send reports to the security company unless an alternate means of transmitting the reports exists.

For telephone communication, your security company can program your security system to automatically disconnect the telephones when sending reports to the security company. Once the report finishes, the security system returns the telephones to normal operation (check with your security company).

Consult with your installer to determine if your security system is configured with a communicator delay. A communicator delay aborts reports to your security company if the control panel is disarmed within 30 to 45 seconds after a burglary alarm is triggered. Note that fire-type alarms are always reported without a delay.

Consult with your installer to determine if your security system is configured with a cancel feature. If you silence a non-fire alarm before the alarm sound timer expires, your security systems sends a cancel report to your security company.

Consult with your installer to determine if your security system is configured with a swinger shutdown feature for non-fire alarms and trouble events. After a programmable number of alarm or trouble events, your security system automatically bypasses points.

If your telephone service includes the call waiting feature, your security company can configure your security system so that call waiting does not interfere with alarm reporting. Be sure to notify your security company if you enable call waiting. A system that is configured for call waiting cannot report alarms correctly when call waiting is disabled. If you disable call waiting after your system has been configured for it, be sure to notify your security company.

7 Alarm events

The system produces several types of events.

7.1 Priority of events

If more than one event occurs, the system sorts them into one of six groups. The groups are (highest priority first): Fire Alarms, Gas Alarms, User Alarms, Burglary Alarms, Fire Troubles, and Non-Fire Troubles. The group with the highest priority scrolls first. The descriptions and instructions that follow describe the tones and displays for each group, and explain how to silence the tones.

7.2 Fire alarms

Fire alarms are the highest priority events. When a fire point activates, the keypad emits a unique pulsating fire tone.

Evacuate all occupants and investigate for smoke or fire. Ensure that all occupants know the difference between the steady burglary tone, the pulsating gas tone, and the pulsating fire tone. The tone sounds for the duration set by your security company.

The display shows the point text of the first point that went into fire alarm. Press /NEXT to manually show additional points (if any) that went into alarm. Events scroll from the oldest to the newest.

7.2.1 Silence fire alarms

Enter your passcode to silence fire alarms. If the system is on (armed), silencing the fire alarm also turns the system off. The system now shows *Alarm Silenced*, and then the number of points in alarm, and the names of all the points in alarm, in the order of occurrence.

Your security company can program your system so that users cannot silence some fire alarms until the fire event clears. Your security company can program the system so that users cannot silence some fire alarms until the fire point has restored to normal (trouble conditions are corrected). The *Alarm Silenced* message continues to scroll as a reminder that you can still view the points in alarm by using the *View Event Memory* menu option.

If the fire point is still in alarm (faulted), the point goes to trouble after silencing. Some fire points need to be reset. You cannot clear fire troubles from the display. When fire points return to normal, the security system automatically clears the fire troubles from the display.

7.3 Gas alarms

Gas alarms are the second highest priority events. When a gas point activates, the keypad emits a unique pulsating gas alarm.

Evacuate all occupants and investigate for gas. Ensure that all occupants know the difference between the burglary tone, the pulsating gas tone, and the pulsating fire tone. The tone sounds for the duration set by your security company.

The display shows the point text of the first point that went into gas alarm. Press /NEXT to manually show additional points (if any) that went into alarm. Events scroll from the oldest to the newest.

7.3.1 Silence gas alarms

Enter your passcode to silence gas alarms. If the system is on (armed), silencing the gas alarm also turns the security system off (disarms the system). The system now shows *Alarm Silenced*, and then the number of points in alarm, and the name of all the points in alarm in the order of occurrence.

Your security company can program the system so that users cannot silence some gas alarms until the gas event clears. Enter your passcode to clear the scrolling point text from the display. The *Alarm Silenced* message continues to scroll as a reminder that you can still view the text of the points in alarm by using the *View Event Memory* menu option.

If the gas point is still in alarm (faulted) then the point goes to trouble after silencing. Some gas points need to be reset. You cannot clear gas troubles from the display. When gas points return to normal (trouble conditions are corrected), the security system automatically clears the gas trouble from the display.

7.4 User and burglary alarms

User alarms have the third priority. User alarms are user initiated alarms that include hold-up, panic, and medical alarms, for example. Medical alarms are not available on UL listed systems. A steady tone sounds for the time set by your security company.

Burglary alarms are the fourth priority. When a burglary point activates while the system is on (armed), the keypad emits a steady burglary tone.

Ensure that all occupants know the difference between the steady user or burglary tone, the pulsating gas tone, and the pulsating fire tone. The tone sounds for the time set by your security company.

7.4.1 Silence user and burglar alarms

The audible alarm sounds for a specific period of time before it automatically shuts off. To silence user and burglary alarms before the time expires, simply enter your personal passcode and press **ENTER**.



Notice!

For silent alarms, such as hold up alarms, no audible alarm sounds.

8 Trouble events

8.1 Fire trouble events

When a fire trouble occurs, the keypad emits the trouble tone (three tones followed by a pause repeated). The system shows the number of fire points with troubles and the name for each point in trouble.

8.1.1 Silence fire troubles

Press **ENTER** to silence the trouble tone.

After you silence the trouble, the text of the fire point in trouble continues to show on the display. Use /NEXT to scroll through the trouble text. Events scroll from oldest to newest. You cannot clear fire troubles from the display until the trouble condition is cleared (the point is normal).

8.2 Gas trouble events

When a gas trouble occurs, the keypad emits the trouble tone (three tones followed by a pause repeated). The system shows the number of gas points with troubles and the name for each point in trouble.

8.2.1 Silence gas troubles

Press **ENTER** to silence the trouble tone.

8.3 User and burglary trouble events

The security company can program a keypad to emit the trouble tone (three tones followed by a pause repeated), when a user or burglary trouble event occurs.

If the system is on, the display shows the number of points with troubles and the name for each point.

8.3.1 Silence user and burglary trouble events

Press **ENTER** to silence the trouble tone.

8.3.2 View user and burglary trouble events

After a user enters a passcode, the name of the point in trouble continues to scroll through the display. Use /NEXT to scroll text manually. Events scroll from oldest to newest.

8.4 System trouble events

Examples of system trouble displays include *Service AC Failure* and *Service Battery Low*. These displays appear on all keypads in the system. All system trouble displays begin with *SERV* or *Service*. The *Service* text clears only after the faulted condition is corrected.

Press **ENTER** to silence the trouble tone.

9 Cleared events are not lost

If you clear the alarms and troubles from the display, you can still view all the events.

Using the events menu you can:

- Select the Event Memory menu to view the alarm and trouble events that occurred since the last time the system was turned on (armed). Turning the system on (arming) clears event memory.
- Select the View Log menu to view all events in your system's event log.

10 View faulted or bypassed points

To turn on (arm) the system, all the doors and windows in the system must be in the normal (not faulted) condition. Viewing the faulted points helps you find faulted points and correct them so arming is possible.

The keypad offers two ways of displaying faulted and bypassed point information. The first causes the faulted or bypassed point information to scroll automatically through the display. The second allows you to manually scroll through each individual point description.

-Notes-

11 B94x Keypad operation overview



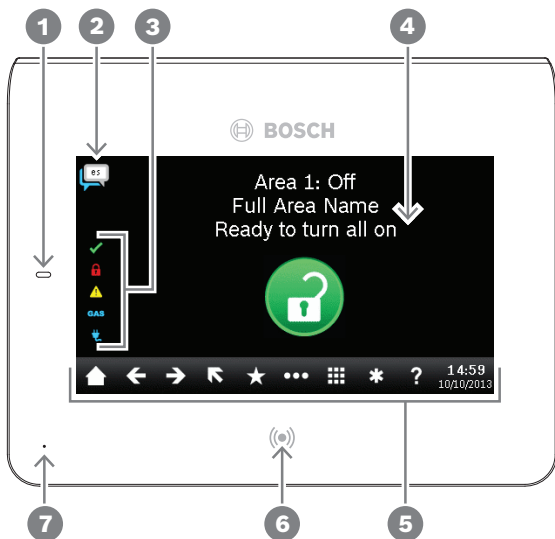

Description of callouts for the keypad overview figure

Callout number	Description
1	Power indicator LED
2	Feature key (refer to <i>Feature key</i> , page 37)
3	Status indicators (refer to <i>Status indicators overview</i> , page 35)

4	Main display area (refer to <i>Main display area</i> , page 30)
5	Ribbon bar (refer to <i>Ribbon bar overview</i> , page 34)
6	Integrated proximity reader (for use with tokens and cards)
7	Presence sensor (lights a dim screen as you approach)

Your security system provides quick access to functions through the keypad menus.

My shortcuts are:

11.1 Main display area

The keypad main display area has several screens that show based on the task performed at the keypad.

11.1.1 Idle screen

When the main display area shows the idle screen, it uses words, numbers, and symbols to show the status of the security system. When several events occur, the keypad shows each event in order of priority.

Area 1: Off
Full Area Name
Ready to turn all on



The Main icon serves as both an indicator of the arming state and alarms, and as an icon to press to change the arming state. The text above the icon provides instructions.



Ready to arm. Indicates that the system is ready to turn on (arm). Press the icon to turn on (arm) the security system.



Not ready to arm. Indicates that the system is not ready to turn on (arm). Press the desired icon to resolve the faults.



On (armed). Indicates that the system is on (armed). Press the icon and enter your passcode to turn off (disarm) the security system.



Part on (armed). Indicates that the system is part on (armed). Press the icon and enter your passcode to turn off (disarm) the security system.



Alarm. The security system is in alarm. Press the icon and enter your passcode to silence any alarms.

Notice!



When on the idle screen, the main display area shows icons to the right or left of the idle text icon when you must press an icon to continue, or when you can choose to perform additional tasks. For example, the **View faulted** icon allows you to look at the list of faulted points.

11.1.2 Keypad screen

The keypad screen shows when the keypad prompts you to enter your passcode or you press .



In addition to the alphanumeric keys, the keypad screen includes three other keys.

ENTER Enter. Press to complete the entry of your passcode, other numbers, or to answer Yes to a keypad request.

CMD CMD (command). Press to initiate a select number of functions that require one or two additional keys.

 Backspace. Press to backspace to remove alphanumeric characters.

11.1.3 QWERTY keyboard screen

The QWERTY keyboard screen shows when you can use alphanumeric characters, such as when entering the name for a new user.



When the QWERTY keyboard first shows, it shows the English alphabet keyboard. In addition to showing the alphabet and spacebar, the QWERTY keyboard has several keys for entering text and changing to other QWERTY -style keyboards.



Shift. Press to enter an uppercase letter or a special character on the numbers keyboard.



Backspace. Press to backspace to remove alphanumeric characters.



Enter. Press to save entered characters and return to the previous menu.



Extended Language keyboard. Press to show the non-English characters keyboard.



Number/special character keyboard. Press to show the numbers and special characters keyboard.



ABC keyboard. Press to show the English alphabet keyboard.

11.2 Ribbon bar overview

The Ribbon bar includes several icons and the date and time. Each icon lights only when available.

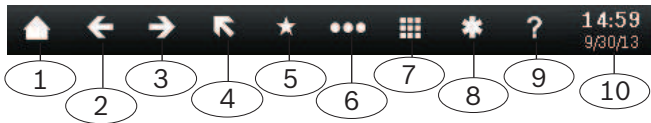

Callout Number	Description
1	Home. Press to return to the home (main) display.
2	Previous. Press to return to the previous screen or menu.

Callout Number	Description
3	Next. Press to advance to the next screen or menu.
4	Esc. Press to exit a menu and return to the previous level. Press and hold to exit and return to idle text from any level of the menu structure.
5	Shortcuts. Press to open the Shortcuts menu to quickly access functions you use most. Your security company programs these shortcuts for you.
6	Menu. Press to open the Main Menu .
7	Keypad. Press to replace the main display area with the keypad screen.
8	Emergency. Press to access the emergency screen. From there you can choose from emergency responses programmed by your security company..
9	Help. Press to open on-display instructions.
10	Time and Date. View the time and date. You do not interact with this area.

11.3 Status indicators overview

The Status indicators on the keypad provide a quick visual reference for you to see how your system is operating.



Ready to arm. The green checkmark indicates whether the system is ready to turn on (arm).

- ON Steady. All points are normal and the system is ready to turn on.
- OFF. One or more points are faulted, and the system is not ready to turn on.



On (armed). The red lock indicates whether the system is on (armed).

- ON Steady. All areas are on with no alarms.
- Flashing. All areas are armed, and there is an active alarm.
- OFF. One or more areas are off.



Trouble. The yellow caution lights when a trouble condition exists.

- ON Steady. There is a system, device, or point trouble.
- OFF. There are no system, device, or point troubles.



GAS. The blue GAS indicates a gas alarm.

- Flashing. An area has a gas alarm. You should leave the premises immediately when there is a gas alarm.
- OFF. A gas alarm does not exist within the keypad's scope.



Power. The blue power plug whether the control panel has AC power.

- ON Steady. The AC (mains) power to the control panel is present.
- Flashing. AC (mains) power to the control panel is not present and the control panel is operating from the battery.
- OFF. There is no power to the control panel.

11.4 Feature key

The Feature key performs a specific function programmed by your security company.

12 B93x keypad operation overview

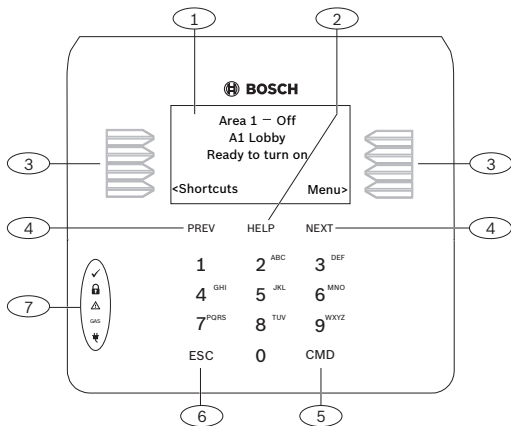

Callout Number	Description
1	Alphanumeric display (refer to <i>Display overview, page 42</i>)
2	HELP key
3	Softkeys
4	PREV and NEXT keys
5	CMD key (Command)
6	ESC key (Escape)

Callout Number	Description
7	Status indicators (refer to <i>Status indicators overview</i> , page 43)

Your security system provides quick access to functions through the keypad menus.

To access menus using a B93x, press **Menu**. Functions programmed by your security company show on the display as menu items, each with its own softkey. To exit a menu and return to the previous level, press **ESC**. To exit and return to idle text from any level of the menu structure, press and hold **ESC**.

The keypad has a Shortcuts menu to quickly access functions you use most. Your security company programmed these Shortcuts for you. To access Shortcuts using a B93x, press **Shortcuts**.

My shortcuts are:

12.1 Keys overview

Each keypad has 10 numeric keys, 5 navigation keys, and eight softkeys. When pressed, keys enable keypad backlighting and emit a muted beep. Use the eight softkeys to select a menu and associated functions.

12.1.1 Keys descriptions

Softkeys

Use softkeys to make a selection when the display shows an arrow pointing from a menu option to the softkey. The idle text display shows the **Menu** and **Shortcuts** softkeys. The Shortcuts menu is the quickest way to access the functions you use most.

ESC

The **ESC** (Escape) key has two uses. First, use the **ESC** (Escape) key to exit from menus and functions. Also, use the key as a backspace when you enter names and numbers.

CMD

Use the **CMD** (Command) key in combination with one or two number keys to perform functions.

PREV and NEXT

Use the **PREV** and **NEXT** keys to scroll through menus or menu selections.

HELP

The **HELP** key has two uses. First, use the key to open the keypad's on-display Help. (Press **ESC** to exit Help when finished.) Also, press and hold the **HELP** key for 2 seconds to change to the security system's second language.

12.2 Display overview

The keypad uses words, numbers, and symbols to show the status of the security system. When several events occur, the keypad shows each event in order of priority. The display shows five lines, 21 characters per line.

The keypad has a bright two-line by 20-character liquid crystal display (LCD). When names are more than 18 characters, the text scrolls horizontally, similar to the way a stock ticker scrolls.

12.3 Status indicators overview

The Status indicators on the keypad provide a quick visual reference for you to see how your system is operating.



Ready to arm. The green checkmark indicates whether the system is ready to turn on (arm).

- ON Steady. All points are normal and the system is ready to turn on.
- OFF. One or more points are faulted, and the system is not ready to turn on.



On (armed). The red lock indicates whether the system is on (armed).

- ON Steady. All areas are on with no alarms.
- Flashing. All areas are armed, and there is an active alarm.
- OFF. One or more areas are off.



Trouble. The yellow caution lights when a trouble condition exists.

- ON Steady. There is a system, device, or point trouble.
- OFF. There are no system, device, or point troubles.



GAS. The blue GAS indicates a gas alarm.

- Flashing. An area has a gas alarm. You should leave the premises immediately when there is a gas alarm.
- OFF. A gas alarm does not exist within the keypad's scope.



Power. The blue power plug whether the control panel has AC power.

- ON Steady. The AC (mains) power to the control panel is present.
- Flashing. AC (mains) power to the control panel is not present and the control panel is operating from the battery.
- OFF. There is no power to the control panel.

13 B94x/B93x menu tree and commands

The keypad offers an easy-to-use menu tree structure. To access the menu tree, press the  icon on a B94x or the **Menu** softkey on a B93x. The Main menu shows first. Each menu selection has its own icon or softkey. Press the icon or softkey to choose that option.

On a B93x, the menu options for each menu tree level are associated with a number based upon the order in which the menu option is shown. You can type the number for the desired menu, if you know it.

The menu tree figure on the next page shows the Menu structure and the numbers associated for each menu (B93x only).

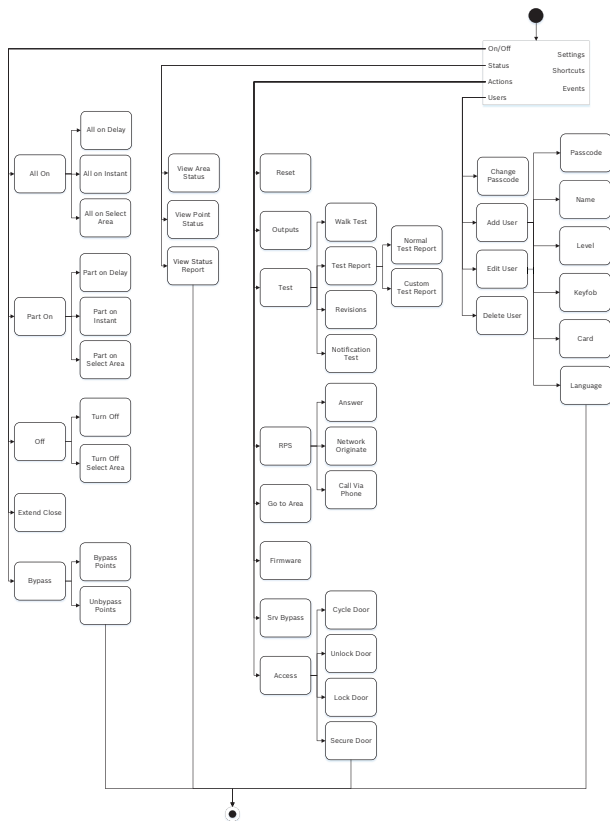

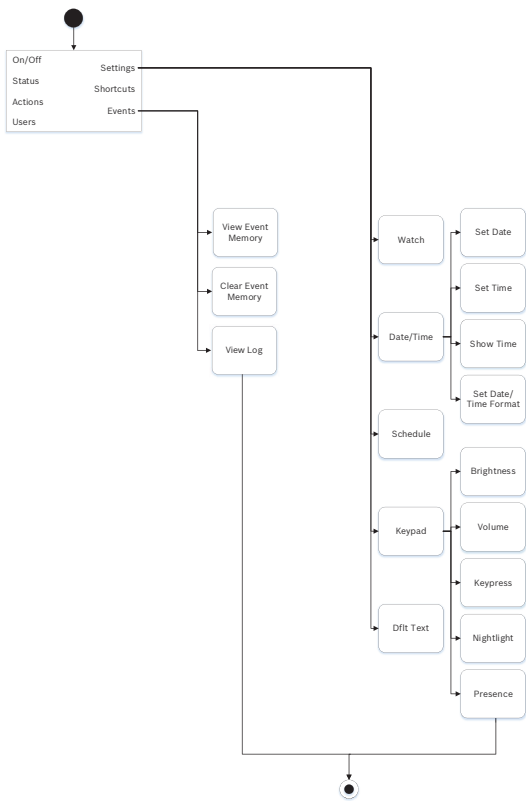



Commands

You can initiate functions with the **CMD** key plus the one or two digit command.

If you know the command number, press the **CMD** key and then the one or two digit command.



Notice!

After you press **CMD**, you can use /PREV or /NEXT to move through the list of commands, and press **ENTER** when viewing the desired command.

Review the available commands in the following table.

Command	Function
CMD 0	Bypass
CMD 0 0	Unbypass
CMD 1	All on (with delay)
CMD 1 1	All On, Instant
CMD 2	Part On, Instant
CMD 3	Part On (with delay)
CMD 4*	Silence Trouble Sounders
CMD 4 0	See Alarms
CMD 4 1*	Test Report
CMD 4 2*	Status Report
CMD 4 3*	RPS Answer
CMD 4 4*	Intrusion Walk Test
CMD 4 5*	Change Date and Time
CMD 4 6**	Door Control Menu
CMD 4 7	Reset Sensors
CMD 4 9*	Change Display
CMD 5 0	Go to Area
CMD 5 1	Extend Close

Command	Function
CMD 5 2*	SKED Menu
CMD 5 3	Delete User
CMD 5 4*	Output Change Menu
CMD 5 5	Change Passcode
CMD 5 6	Add User
CMD 5 8*	Fire Walk Test
CMD 5 9	Show Revision
CMD 6	Watch Mode
CMD 7*~	Special Alert _____
CMD 8	Open Main menu
CMD 9*~	Special Alert _____
*Requires firmware v3.0x or higher. #B9512G/B8512G only. ~As configured by your security company.	

14 B94x/B93x On/Off menu

Use the On/Off menu to turn areas All or Part On, to turn areas off, to extend closing time, or to bypass points.

When you turn on (arm) your security system, there is an exit delay that gives you time to leave the area without sounding the burglary tone.

When you enter a security system that is turned on (armed), there is an entry delay that gives you time to turn off (disarm) the system.

14.1 All On menu

Use the On/Off menu to turn areas All or Part On, to turn areas off, to extend closing time, or to bypass points.

When you turn on (arm) your security system, there is an exit delay that gives you time to leave the area without sounding the burglary tone.

When you enter a security system that is turned on (armed), there is an entry delay that gives you time to turn off (disarm) the system.

14.1.1 All On

Turning an area All On turns on all points in the area and provides entry and exit delay. For example, you can turn on the area and leave through a door (within exit delay time) without creating an alarm event. When you turn the area All On, the display shows how many seconds of exit delay time remain to exit the protected area. Leave before the exit delay time expires.

Leaving after exit delay expires causes entry delay to start. It may also cause an alarm on an interior device. Enter your passcode to turn off the system.

Turning areas All On:

1. Open the **Main Menu**.
2. Press **On/Off** to open the menu.
3. Press **All On** to open the menu.
4. Press **All On Delay** to open the menu.
5. Enter your passcode and press **ENTER**. The keypad shows *Exit Now!* and sounds during the exit delay.
6. Exit the area or enter your passcode again to stop the system from turning on. If you turn your system All On and don't exit, the system automatically switches to Part On.

14.1.2 All On Instant

Turning an area All On Instant turns on all points with no entry or exit delay. When areas are All On Instant, faulting any point (opening a door for example) creates an alarm event immediately.

Turning areas All On Instant:

1. Open the **Main Menu**.
2. Press **On/Off** to open the menu.
3. Press **All On** to open the menu.
4. Press to **All On Instant** open the menu.
5. Enter your passcode and press **ENTER**. The keypad shows *All On*.
6. To turn off the security system, enter your passcode and press **ENTER**.

14.1.3 Select Area

Use All On Select to choose individual areas to turn All On or All On Instant. You choose areas from a list of the areas in which you have authority.

Turning on a specific area:

1. Open the **Main Menu**.
2. Press **On/Off** to open the menu.
3. Press **All On** to open the menu.
4. Press **All On Select Area** to open the menu.
5. Enter your passcode and press **ENTER** .
6. Press either **On Delay** or **On Instant**. The keypad responds based upon your selection.

14.2 Part On menu

Use the Part On menu to turn areas Part On. Turning an area Part On means to turn on only some of the points, and thus part of the system. For example, your security company might configure your system so that when you use the Part On function, only the exterior doors and windows turn on, whereas interior motion sensors do not turn on.

14.2.1 Part On

Turning an area Part On turns on some points, or part of the system, in the area and provides entry and exit delay. For example, you can turn on the area and leave through a door (within exit delay time) without creating an alarm event.

Turning the perimeter on with an exit delay:

1. Open the **Main Menu**.
2. Press **On/Off** to open the menu.
3. Press **Part On** to open the menu.
4. Press **Part On Delay** to open the menu.
5. Enter your passcode and press **ENTER**. The keypad shows *Part On Delay*.

14.2.2 Part On Instant

Turning an area Part On turns on some points, or part of the system, in the area with no entry or exit delay. When the area is Part On Instant, faulting a Part On point (opening a door for example) creates an alarm event immediately.

Turning the system Part On without delay:

1. Open the **Main Menu** .
2. Press **On/Off** to open the menu.
3. Press **Part On** to open the menu.
4. Press **Part On Instant** to open the menu.
5. Enter your passcode and press **ENTER**. The keypad shows *Part On Instant*.

14.2.3 Select Area

Use Part On Select to choose individual areas to turn Part On or Part On Instant. You choose areas from a list of the areas in which you have authority.

Turning individual areas Part On:

1. Open the **Main Menu**.
2. Press **On/Off** to open the menu.
3. Press **Part On** to open the menu.
4. Press **Part On Select Area** to open the menu.
5. Enter your passcode and press **ENTER**.
6. Press either **On Delay** or **On Instant**. The keypad responds based upon your selection.

14.3 Off menu

You can turn areas off simply by entering your passcode or by using the Off menu. With either option, you turn off all areas in which you have authority.

You must enter your personal passcode and enter through a designated entry door to prevent an instant alarm condition. Opening the door starts entry delay time and the keypad emits a pulsing “beep” tone to remind you to turn the system off. Enter your passcode before the entry delay time expires.

If you enter through the wrong door or fail to turn off (disarm) before the entry delay time expires, an alarm occurs. If this happens, silence the alarm (by entering your personal passcode and pressing **ENTER**) and call your security company to notify them that you do not have an emergency situation.

Turning off the security system (disarm) with your passcode:

1. Enter your personal passcode.
2. Press **ENTER** within 8 sec of entering your passcode. The display returns to idle text.

14.3.1 Turn Off

You can use the Turn Off menu to turn off all areas in which you have authority.

Turning off areas:

1. Open the **Main Menu**.
2. Press **On/Off** to open the menu.
3. Press **Off** to open the menu.
4. Press **Turn Off** to turn off.
5. Enter your passcode and press **ENTER**. The display returns to idle text.

14.3.2 Turn Off Select

Use Turn Off Select to choose individual areas to turn off. You choose areas from a list of the areas in which you have authority.

Turning off a specific area:

1. Open the **Main Menu**.
2. Press **On/Off** to open the menu.
3. Press [Off] to open the menu.
4. Press **Turn Off Select Area** to open the menu.
5. Enter your passcode and press **ENTER**. The display returns to idle text.

14.4 Extend Closing

Your security company might program your system to expect you to turn on (arm) within a closing window. A closing window is a duration of time programmed by your security company. Your security company sets a fixed length of time for the closing window. Additionally, your security company might program your system to automatically turn on (arm) at the end of the window.

Use the Extend Close Time option when you need to stay later than the scheduled close time. If you do not extend the Close Time and do not turn the system on before the scheduled time, the system creates a Late to Close event.

At the beginning of the closing window, the keypad beeps and shows **Please Close Now** to remind you to turn on (arm) your system. It remains in the display until you turn on the system, the close window ends, or you extend closing. Alarm or trouble messages replace this message in the event of an alarm or trouble condition. If the alarm or trouble condition clears before the end of the close window **Please Close Now** returns to the keypad display.

Pressing **ESC** silences the beep and clears the message for 10 minutes. If you have not turned your system on (armed) or extended closing, the **Please Close Now** message and beep reappear after 10 minutes. To extend the window, enter the new time at which you would like the reminder tone to begin. This time is the new beginning of the closing window.

When you hear the warning, you can:

- Leave before the end of the closing window by pressing **ESC** to silence the signal, turning on the system, and leaving.
- Stay past the scheduled end of the closing window, by using this function to extend the closing window.

To extend closing:

1. Open the **Main Menu**.
2. Press **On/Off** to open the menu.
3. Press **Extend Close** to open the menu.
4. Enter your passcode and press **ENTER**.



Notice!

You cannot extend the window across the midnight boundary. The system cannot arm if points are off-normal.

14.5 Bypass

Use the Bypass menu to temporarily take points out of the security system, and enter them back into the system. Bypassed points do not create alarm or trouble events, do not detect intruders, and cannot send any reports. For example, to leave a window open and turn the system on, you bypass the window point and then turn the system on.

14.5.1 Bypass Points

You can bypass points when an area is turned off (disarmed). Points remain bypassed until you unby pass them or some points return when the area is turned off (disarmed). Use point bypassing with discretion: bypassing a point reduces the level of security.

Bypassing a point:

1. Open the **Main Menu**.
2. Press **On/Off** to open the menu.
3. Press **Bypass** to open the menu.
4. Press **Bypass Points** to open the menu.
5. Select a point to bypass.
6. Escape from the menu.

14.5.2 Unbypass Points

Unbypassing a point returns a bypassed point to the security system so that it can once again respond to trouble and alarm conditions.

Unbypassing a point:

1. Open the **Main Menu**.
2. Press **On/Off Menu** to open the menu.
3. Press **Bypass** to open the menu.
4. Press **Unbypass Points** to open the menu.
5. Select a point to unbypass.
6. Escape from the menu.

15 B94x/B93x Status menu

Use the Status menu to see area or point status, or to send a status report.

15.1 View Area Status

Area Status shows the on/off status for areas in which you have authority.



Viewing area status:

1. Open the **Main Menu**.
2. Press **Status** to open the menu.
3. Press **View Area Status** to open the menu.
4. Enter your passcode and press **ENTER**. The display shows the status of each area. For example *A-1: Off*.
5. Escape from the menu.

15.2 View Point Status

The View Point Status feature shows the status (normal, open, or short) for all points in the areas in which you have authority.

Viewing point status:

1. Open the **Main Menu**.
2. Press **Status** to open the menu.
3. Press **View Area Status** to open the menu.
4. Enter your passcode and press **ENTER**.
5. The display shows the number of points in the system. Use /
PREV or /**NEXT** to scroll through the list of points and each point's status.
6. Escape from the menu.

15.3 Send Status Report

The Send Status Report feature sends a complete system status report to your security monitoring company. Status reports can alert them to potential problems.

Sending a status report:

1. Open the **Main Menu**.
2. Press **Status** to open the menu.
3. Press **Send Status Report** to open the menu.
4. Enter your passcode and press **ENTER**. The control panel sends a report to your security company.

16 B94x/B93x Actions menu

Use the Actions menu to reset sensors, change outputs, see the test menu, see the RPS menu, go to an area, update system firmware, or to view service bypassed points.

16.1 Reset

Detection devices, such as smoke detectors and shock sensors, might require a reset action before they return to normal operation. This function momentarily removes power from these devices to reset them.

Resetting sensors:

1. Open the **Main Menu**.
2. Press **Actions** to open the menu.
3. Press **Reset** to open the menu.
4. Enter your passcode and press **ENTER**. The display shows *Sensors resetting* for approximately 3 seconds and then goes blank before returning to idle disarmed text.

If you enter this function and the detector or sensor resets momentarily, but then returns to a faulted condition, the conditions causing the activation may still be present or the detector may be faulty. Check to be certain that there is no smoke, fire, or other danger present.

If you cannot reset the detector or sensor, contact your security company.

16.2 Outputs

Your security company programs outputs for automatic control and/or keypad control of devices such as premises lighting or entry gates. An output is a device that is controlled by the security system. Contact your security company for further information regarding the use of outputs in your security system.

Use this function to select outputs to turn on or off. Outputs on your security system can control other systems, lighting for example.

Security systems using B5512/B4512/B3512 control panels are not UL investigated for access control.

Turning outputs on and off:

1. Open the **Main Menu**.
2. Press **Actions** to open the menu.
3. Press **Outputs** to open the menu.
4. Enter your passcode and press **ENTER**.
5. Use /NEXT to select the desired output value, or use the number keys to enter the value.
6. Press **Turn On** or **Turn Off**.
7. Escape from the menu.

16.3 Test

Use the Test menu to walk test your system, send test reports, or to review system revision information on the keypad display.

16.3.1 Walk Test

A walk test allows you to test the sensors, keypads, sounders, and other devices in your system without creating alarm events. You can review untested points at the keypad to help pinpoint any problems.

You cannot turn on the security system while in the walk test mode. Also, the security system does not create alarm events for points included in the walk test. Points not included create alarm events. For example, faulting a fire point during an intrusion walk test creates a fire alarm event.

Beginning the walk test activates the burglary tone for 2 seconds. A battery test also begins. A successful battery test ends in four minutes (the walk test continues). If the security system determines there is a low battery, it generates a low battery event and continues the test. If the battery is determined to be very low, the system creates a missing battery event and ends the battery test immediately.

To test individual detection devices, simply activate sensors and open protected doors and windows one-at-a-time. As you fault each detection device, the keypad from which you initiated the test emits a brief tone, and for 60 seconds the display indicates that the point was tested. The tone and display verify that each detection device is working properly. Keypads within the area's scope from which you did not initiate the walk test show *Walk test in progress* during the testing.



Notice!

Fire walk test includes gas

When you perform a Fire walk test, the security system tests any 24-hour points that are not invisible, including gas points.

Performing a walk test:

1. Open the **Main Menu**.
2. Press **Actions** to open the menu.
3. Press **Test** to open the menu.
4. Press **Walk Test** to open the menu.
5. Press **Fire, Intrusion, Service, or Invisible** based upon the type of walk test you wish to perform.
6. The keypad shows the number of points remaining to test. Press **View untested points**.
7. Use /NEXT to go through your desired point and view the status of that point.
8. Escape from the menu.

Automatic termination

The Walk Test automatically ends after 20 minutes of no test activity. The keypad sounds during the last 5 minutes of the test.

16.3.2 Send Test Report

This function tests the communication link between your security system and your security company. It is an important part of maintaining a high level of security for your property.

You can either send a normal test report or a custom test report:

- Normal test report: Includes all route groups that have the test report function enabled, independent of which destination device is used to communicate. The test report is sent to the first successful destination device in a route group.
- Custom test report: You can select the route group and destination device you want to test. You can either test one destination device per route group or all configured destination devices for a route group.

Sending a normal test report:

1. Open the **Main Menu**.
2. Press **Actions** to open the menu.
3. Press **Test** to open the menu.
4. Press **Test Report** to open the menu.
5. Press **Normal Test**.
6. Enter your passcode and press **ENTER**.
The system sends a normal test report.
7. Escape from the menu.

Sending a custom test report:

1. Open the **Main Menu**.
2. Press **Actions** to open the menu.
3. Press **Test** to open the menu.
4. Press **Test Report** to open the menu.
5. Press **Custom Test**.
6. Select the route group you want to test.

7. Select the destination you want to test.
8. Enter your passcode and press **ENTER**.
The system sends a custom test report.
9. Escape from the menu.

16.3.3 Revisions

Use this function to view the current revision of your control panel firmware.

Viewing the current revision of your system (control panel):

1. Open the **Main Menu**.
2. Press **Actions** to open the menu.
3. Press **Test** to open the menu.
4. Press **Revisions** to open the menu.
5. Enter your passcode and press **ENTER**. The current revision information shows on the display.
6. Escape from the menu.

16.3.4 Notification Test

Use this menu to test the security system's ability to send personal notification messages to the destination path designated by your security company.

Testing notifications:

1. Open the **Main Menu**.
2. Press **Actions** to open the menu.
3. Press **Test** to open the menu.
4. Press **Notification Test** to open the menu.
5. The keypad shows the first properly configured notification path.

Use /NEXT to go to the desired notification path, and then press **ENTER**. The control panel sends a test notification, and then returns to idle text.

16.4 RPS

Use the RPS menu for connection to Remote Programming Software (RPS). Your security company uses RPS to configure and service your security system. RPS is intended for use by professional or licensed installers only.

16.4.1 Answer

Use the Answer option to answer the phone (pick up the phone line) to connect to RPS.

Using the Answer menu option to answer an incoming call from RPS:

1. Open the **Main Menu**.
2. Press **Actions** to open the menu.
3. Press **RPS** to open the menu.

4. Press **Answer** to open the menu.
5. Enter your passcode and press **ENTER**.

The keypad shows *RPS is connecting....* and then returns to idle text.

16.4.2 Network Originate

Use this function to originate an RPS session using an internet connection.

Connecting to RPS using an internet connection:

1. Open the **Main Menu**.
2. Press **Actions** to open the menu.
3. Press **RPS** to open the menu.
4. Press **Network Originate** to open the menu.
5. To use the programmed port number, press **Configured Port**. The connection progress begins.
6. If you wish to change the port number before connecting, press **Change Port**. Press **ENTER**. The connection progress begins.

16.4.3 Call Via Phone

Use this function to call RPS using the phone line.

Connecting to RPS via the phone line:

1. Open the **Main Menu**.
2. Press **Actions** to open the menu.
3. Press **RPS** to open the menu.
4. Press **Call Via Phone** to open the menu.
5. Enter your passcode, press **ENTER**. The connection progress begins.

16.5 Go to area

With the Go to Area function you can perform tasks in an area other than the one you're in without having to physically go to that area. For example, using the keypad in the office area, you could 'go' to the loading area. You select the area from a list of areas in which you have authority.

Once you 'go' to an area, you can perform tasks you have authority for in that area. To 'leave' an area press [ESC].

Using Go to Area:

1. Open the **Main Menu**.
2. Press **Actions** to open the menu.
3. Press **Go to Area** to open the menu.
4. Enter your passcode and press **ENTER**.
5. Use /NEXT to go to the area you wish to enter, and then press **Go to Area**.

16.6 Firmware

Your security company might have configured your security system to require your authorization before system firmware can be updated. Use this action to provide authorization at the request of your security company. Local authorization is required for UL listed systems.

Authorizing a firmware update:

1. Open the **Main Menu**.
2. Press **Actions** to open the menu.
3. Press **Firmware** to open the menu.
4. Enter your passcode and press **ENTER**.

16.7 Service bypass

To facilitate system maintenance for service personnel, your security system comes with a special point bypass option to remove any point from service. Bypassed points are not protected. Use this menu to view bypassed points.

Viewing points in Service Bypass:

1. Open the **Main Menu**.
2. Press **Actions** to open the menu.
3. Press **Srv Bypass** to open the menu. The keypad shows any points in service bypass.

16.8 Access menu

Use the Access menu to control doors.

When you open Access menu options and the desired door number, the keypad shows the door state.

State	Meaning
Cycling	The cycle door function is running (door can be opened during the cycle function).
Unlocked	The door is unlocked (you do not need to activate a door request or present a valid credential).
Secure	The door is secured (door cannot be opened when secured, even if you present a valid credential).
Fail	The door is in a failed state. Call your security company.
Locked	The door is locked (door can be opened by presenting a valid credential).

This feature is:

available on my system.

unavailable on my system.

16.8.1 Cycle Door

Use the Cycle Door menu to allow access during the cycle time (door can be opened).

Cycling a door:

1. Open the **Main Menu**.
2. Press **Actions** to open the menu.
3. Press **Access** to open the menu.
4. Press **Cycle Door** to open the menu.
5. Enter your passcode and press **ENTER**.
6. Use **PREV** or **NEXT** to scroll to the desired door. The keypad shows the door status.
7. Press **ENTER**. The door cycles.
8. Escape from the menu.

16.8.2 Unlock Door

Use the Unlock Door menu to unlock a door to allow free access.

Unlocking a door:

1. Open the **Main Menu**.
2. Press **Actions** to open the menu.
3. Press **Access** to open the menu.
4. Press **Unlock Door** to open the menu.
5. Enter your passcode and press **ENTER** .
6. Use **PREV** or **NEXT** to scroll to the desired door. The keypad shows the door status.
7. Press **ENTER**. The door unlocks.
8. Escape from the menu.

16.8.3 Lock Door

Use the Lock Door menu to lock an unlocked door. Also use this menu to lock doors that were automatically opened during a fire alarm. Once a door is locked, a user must present a card to enter, or send an Unlock or a Cycle command from the keypad to allow the door to open.

Locking a door:

1. Open the **Main Menu**.
2. Press **Actions** to open the menu.
3. Press **Access** to open the menu.
4. Press **Lock Door** to open the menu.
5. Enter your passcode and press **ENTER**.
6. Use **PREV** or **NEXT** to scroll to the desired door. The keypad shows the door status.
7. Press **ENTER**. The door locks.
8. Escape from the menu.

16.8.4 Secure Door

Use the Secure Door menu to secure and unsecure doors. A secured door cannot be opened by presenting a valid credential or by using the cycle function.

Securing a door:

1. Open the **Main Menu**.
2. Press **Actions** to open the menu.
3. Press **Access** to open the menu.
4. Press **Secure Door** to open the menu.
5. Enter your passcode and press the **ENTER**.
6. Use **PREV** or **NEXT** to scroll to the desired door. The keypad shows the door status.
7. Press **ENTER**. The door secures.
8. Escape from the menu.

17 B94x/B93x Users menu

Use the Users menu to change your own passcode, add new users, edit existing users, or to delete users.

17.1 Change Passcode

Use the Change Passcode function to change your personal passcode. Before you begin, consider the following:

- Choose a new passcode three to six digits long. If you choose a passcode with the same digit in consecutive order (for example “33” in 334697), take care when entering it.
- To avoid conflicting with other passcodes and duress codes, your security system does not let you change to existing passcodes or passcodes that are within plus or minus 2 of an existing passcode. For example, if 1234 is an existing code, your security system does not let you change your code to 1232, 1233, 1234, 1235, or 1236.

Changing your passcode:

1. Open the **Main Menu**.
2. Press **Users**. Press **Change Passcode** to open the menu.
3. Enter your current passcode and press **ENTER**.
4. Enter your new passcode and press **ENTER**.
5. Enter your new passcode again and press **ENTER**.
6. Escape from the menu.

17.2 Add User

Use the Add User function to add a passcode to your security system. Before you add the user, you need to know which user numbers are available, the authority level you want to assign to the new passcode, and the areas in which it will be valid.

The user numbers identify users in reports transmitted from your security system. The authority level determines what system functions the passcode can access. The area number identifies which parts of your security system the passcode can access. Contact your security company if you don't know what user numbers, authority levels, or areas are available.

Before you begin:

- Do not try to add passcodes without knowing the available user numbers. These numbers are not to be confused with passcodes that identify users at your security company.
- Choose a new passcode three to six digits long. If you choose a passcode with the same digit in consecutive order (for example “33” in 334697), take care when entering it.
- To avoid conflicting with other passcodes and duress codes, your security system does not let you add passcodes that are within plus or minus 2 of an existing passcode. For example, if 1234 is an existing code, your system does not let you change your code to 1232, 1233, 1235, or 1236.
- Choose an authority level for each area. Leaving the authority level for an area blank by pressing **ENTER** without making an entry, denies the passcode access to that area.

Adding a user:

1. Open the **Main Menu**.
2. Press **Users**.
3. Press **Add User** to open the menu.
4. Enter your passcode and press **ENTER**.
5. Enter the number (1 - 50) for the user you wish to add, and press **ENTER**.

Configuring the user's passcode:

1. Press **Passcode** to set the passcode.
2. Press **ENTER** to continue.
3. Enter the user's passcode and press **ENTER**.
4. Enter the passcode again and press **ENTER**. The keypad shows *Passcode changed* and then returns to the previous menu.

Configuring the user's name:

1. Press **Name** to configure the user's name.
2. The B94x offers a qwerty keyboard. For a B93x, press a number key repeatedly to scroll through the number and letters shown on the key. To enter a space, press [0][0]. To capitalize a letter, press **CMD** before you enter the letter. For caps lock, press **CMDCMD**. To remove caps lock, press **CMDCMDCMD**.
3. Press **ENTER** to save the name. The keypad returns to the previous menu.

Configuring the user's level:

1. Press **Level** to assign an authority level.
2. Press **ENTER** to continue.
3. Press **Yes** to change the default authority level for area 1.
4. Enter the authority level number (1 - 14) you wish to apply to the user and press **ENTER**. The keypad shows *Level configured* and returns to the previous menu.
5. If your security system has more than one area, use **NEXT** and the previous two steps to set the levels for the additional areas.

Configuring a RADION keyfob or an Inovonics Transmitter for the user:

1. Press **Keyfob** to assign a RADION keyfob or an Inovonics Transmitter to the user.
2. To manually enter the RFID, if desired, press **Enter RFID** to add the RFID. Otherwise, the keypad automatically learns the RFID into the security system when you add a RADION keyfob or an Inovonics Transmitter.
3. Press **ENTER** to continue.
4. Enter the RFID.
5. Press **Save** to save the RFID and return to the previous menu.
6. Press **Add** to add a RADION keyfob or an Inovonics Transmitter.
7. Press **Add** to continue.
8. On a RADION keyfob, press any button on the keyfob. On an Inovonics Transmitter, open the transmitter and press the RESET button, per the manufacturer's instructions. The keypad shows *Keyfob enrolled*.
9. If you need to replace the keyfob or transmitter you just added (for example, you accidentally added the wrong one), press **Replace** and then **Replace**, and follow the previous step.
10. You can remove the added keyfob or transmitter by pressing **Remove**.
11. Escape from the menu.

This feature is:



available on my system.



unavailable on my system.

Adding card to a user:

1. Press **Card**.
2. Press **ENTER** to continue.
3. Present the card at the card reader. The keypad shows *Present card*.
4. If the reader identifies the card correctly, the keypad shows *Card configured*.
5. Escape from the menu.

This feature is:



available on my system.



unavailable on my system.

Selecting a keypad display language for the user:

1. Press **Language** to select the user's language.
2. Press **ENTER** to continue.
3. Select the desired language. The keypad shows *Language configured*, and then returns to the previous menu.

Enabling and disabling for mobile app connectivity for the user:

1. Press [Mobile App] to enable or disable mobile app access.
2. Press **ENTER** to continue. The current state (enabled/disabled) shows.

3. Press [Enable] or [Disable] to change the setting. The keypad indicates the new configuration and then returns to the previous menu.

17.3 Edit User

Use the Edit User function to edit a user of your security system. You need to know the user number for the user you want to edit.

Editing an existing user:

1. Open the **Main Menu**.
2. Press **Users** to open the menu.
3. Press **Edit User** to open the menu.
4. Enter your passcode and press **ENTER**.
5. Enter the number (1 - 50) for the user you wish to edit, and press **ENTER**.
6. The keypad shows the name for the user number you entered. Press **Continue**.

Configuring the user's passcode:

1. Press **Passcode** to set the passcode.
2. Press **ENTER** to continue.
3. Enter the user's passcode and press **ENTER**.
4. Enter the passcode again and press **ENTER**. The keypad shows *Passcode changed* and then returns to the previous menu.

Configuring the user's name:

1. Press **Name** to configure the user's name.
2. The B94x offers a qwerty keyboard. For a B93x, press a number key repeatedly to scroll through the number and letters shown on the key. To enter a space, press [0][0]. To capitalize a letter, press **CMD** before you enter the letter. For caps lock, press **CMDCMD**. To remove caps lock, press **CMDCMDCMD**.
3. Press **ENTER** to save the name. The keypad returns to the previous menu.

Configuring the user's level:

1. Press **Level** to assign an authority level.
2. Press **ENTER** to continue.
3. Press **Yes** to change the default authority level for area 1.
4. Enter the authority level number (1 - 14) you wish to apply to the user and press **ENTER**. The keypad shows *Level configured* and returns to the previous menu.
5. If your security system has more than one area, use **NEXT** and the previous two steps to set the levels for the additional areas.

Configuring a RADION keyfob or an Inovonics Transmitter for the user:

1. Press **Keyfob** to assign a RADION keyfob or an Inovonics Transmitter to the user.
2. To remove a previously added keyfob or transmitter, press **Remove**.
3. To replace a previously added keyfob or transmitter, press **Replace** and then **Replace**, and follow the next step.
4. On a RADION keyfob, press any button. On an Inovonics Transmitter, open the transmitter and press the RESET button, per the manufacturer's instructions. The keypad shows *Keyfob enrolled*.
5. To add a RADION keyfob or an Inovonics Transmitter, press **Add** to continue, and follow the previous step.
6. To manually enter the RFID, if desired, press **Enter RFID** to add the RFID. Otherwise, the keypad automatically learns the RFID into the security system when you add a RADION keyfob or an Inovonics Transmitter.
7. Press **ENTER** to continue.
8. Enter the RFID.
9. Press **Save** to save the RFID and return to the previous menu.

Adding or replacing a card for the user:

1. Press **Card**.
2. Press **ENTER** to continue.
3. Present the card at the card reader. The keypad shows *Present card*.
4. If the reader identifies the card correctly, the keypad shows *Card configured*.
5. Escape from the menu.

Selecting a keypad display language for the user:

1. Press **Language** to select the user's language.

2. Press **ENTER** to continue.
3. Select the desired language. The keypad shows *Language configured*, and then returns to the previous menu.

Enabling and disabling for mobile app connectivity for the user:

1. Press [Mobile App] to enable or disable mobile app access.
2. Press **ENTER** to continue. The current state (enabled/disabled) shows.
3. Press [Enable] or [Disable] to change the setting. The keypad indicates the new configuration and then returns to the previous menu.

17.4 Delete User

Use the Delete User function to delete a user.

Use this function to remove users from the system. All user data (name, passcode, keyfob) is deleted and cannot be recovered. Use Edit User if you only wish to remove a user's authority (disable the user), but retain the user's data. You need to know the user number for the passcode you want to delete. The user numbers identify users in reports transmitted from your system.

Deleting a user:

1. Open the **Main Menu**.
2. Press **Users** to open the menu.
3. Press **Delete User** to open the menu.
4. Enter your passcode and press **ENTER**.
5. Enter the number (1 - 50) for the user you wish to delete, and press **ENTER**. The keypad shows the name for the user number you entered.
6. Press **Continue**.
7. Press **Yes** to confirm you wish to delete the selected user. The keypad shows *User ## deleted*, and then returns to the previous menu.
8. Escape from the menu.

18 B94x/B93x Settings menu

Use the Settings menu to turn Watch mode on or off, set the system date and time, view and change schedules, set keypad brightness and volume, and show the time in the keypad display.

18.1 Watch Mode

You can use Watch Mode to monitor select points with the security system turned off. Each time points are faulted (door or window is opened), the keypad chimes once and shows the point text for 60 seconds. The control panel does not generate alarms in this mode except 24-hour alarms (fire, panic, etc.).

Use this function in residential systems to monitor entries or exits in your home. In commercial systems it can serve as a door chime to alert you when a customer or delivery person enters your business.

Entering and exiting Watch Mode:

1. Open the **Main Menu**.
2. Press **Settings** to open the menu.
3. Press **Watch** to open the menu.
4. Enter your passcode and press **ENTER**.
5. Press **Turn On** or **Turn Off**. The keypad indicates that you enabled or disabled Watch Mode successfully.
6. Escape from the menu.

18.2 Date/Time

Your security system must have the correct time and date for scheduled events to occur at the correct times. Use the Date/Time function to set both the time and date. The security system uses a 12-hour AM/PM format or a 24 hour format (select in the Date format menu option).

If your security system is configured for automatic date/time updates, the update might overwrite your changes.



Setting the date and time:

1. Open the **Main Menu**.
2. Press **Settings** to open the menu.
3. Press **Date/Time** to open the menu.
4. Press **Set Date** to open the menu.
5. Enter your passcode and press **ENTER**.
6. Enter the new date in the selected format.
7. Press **Save/ENTER** to save the change. The keypad shows **Date change complete** and then returns to the previous menu.
8. Press **Set Time** to open the menu.
9. Press **Set**.
10. Enter the new time in the selected format.
11. For B93x keypads in 12 hour format, press **AM** or **PM**.
12. Press **Save/ENTER** to save the change. The keypad shows **Time change complete** and then returns to the previous menu.
13. Escape from the menu.

18.3 Schedule (SKEDs)

A SKED is a function programmed to be performed automatically at a scheduled time by your security system. You can change the scheduled time for SKEDs, disable a SKED to prevent it from automatically happening, or restart a previously disabled SKED. Contact your security company to determine what SKEDs they programmed for your system.

Selecting a SKED to change:

1. Open the **Main Menu**.
2. Press **Settings** to open the menu.
3. Press **Schedule** to open the menu.
4. Enter your passcode and press **ENTER**.
5. Use /**PREV** or /**NEXT** to scroll through the list of SKEDs. The keypad indicates whether a SKED is enabled, disabled, or not yet programmed.
6. Continue to *Enabling a disabled SKED* or *Disabling a enabled SKED*.

Enabling a disabled SKED:

1. With the SKED you wish to enable showing, press **Enable the sked**.
2. Press **Exclude holidays** or **Include holidays**.
3. Enter the new time in HH:MM format.
4. Press **ENTER** to save the time and choose AM or PM.
5. Press **AM** or **PM**. The keypad shows *Schedule update complete* and then returns to the previous menu.
6. Escape from the menu.

Disabling an enabled SKED:

1. With the SKED you wish to disable showing, press **Disable the sked**.
2. Press **ENTER** to disable the SKED. The keypad display indicates that the SKED is disabled.
3. Escape from the menu.



18.4 Keypad

Use the Keypad menu to adjust the brightness of the keypad display, the keypress volume, and enable or disable the keypress tone.

18.4.1 Brightness

Use the Brightness function to adjust the brightness level for the keypad display.



Adjusting the keypad display brightness:

1. Open the **Main Menu**.
2. Press **Settings** to open the menu.
3. Press **Keypad** to open the menu.
4. Press **Brightness** to open the menu.
5. Use /PREV or /NEXT to adjust the brightness level. The changes apply immediately.
6. Escape from the menu.

18.4.2 Volume

Use the Volume function to adjust the keypress volume level for the keypad.

Adjusting the keypress volume:

1. Open the **Main Menu**.
2. Press **Settings** to open the menu.
3. Press **Keypad** to open the menu .
4. Press **Volume** to open the menu.
5. Use /PREV or /NEXT to adjust the volume level. The changes apply immediately.
6. Escape from the menu.

18.4.3 Keypress

Use the Keypress function to activate or deactivate the keypress tone.

Activating and deactivating the keypress tone:

1. Open the **Main Menu**.
2. Press **Settings** to open the menu.
3. Press **Keypad** to open the menu.
4. Press **Keypress** to open the menu.
5. Press **Turn On** or **Turn Off**.
6. Escape from the menu.

18.4.4 Nightlight

Use the Nightlight menu to turn the nightlight feature on or off. The nightlight feature dimly lights the display and keys when the keypad is idle, making it easier to find the keypad in a dark room.

Turning the nightlight feature on or off:

1. Open the **Main Menu**.
2. Press **Settings** to open the menu.
3. Press **Keypad** to open the menu.
4. Press **Nightlight** to open the menu.
5. Press **Turn On** or **Turn Off**.
6. Escape from the menu.

18.4.5 Presence (B94x only)

The keypad uses the presence sensor to brighten the display as you approach.

Turning the presence sensor on or off:

1. Open the **Main Menu**.
2. Press **Settings** to open the menu.
3. Press **Keypad** to open the menu.
4. Press **Presence** to open the menu.
5. Press **Turn On** or **Turn Off**.
6. Escape from the menu.

19 B94x/B93x Shortcuts menu

Use shortcuts to quickly access common functions.

Using a shortcut:

1. From the **Main Menu**, press **Shortcuts**, or simply press /**Shortcuts** while viewing idle text.
2. Press the softkey for the desired Shortcut. If more than four Shortcuts are available, the **NEXT** key lights, and you can use the key to view additional Shortcuts.

20 B94x/B93x Events menu

Use the Events menu to view event memory, clear event memory, or view the event log.

20.1 View Event Memory

Your security system stores events that occurred since the last time memory was cleared. Use View Event Memory to view the events not previously cleared. Each time you turn the security system on, the event memory is erased.

Viewing event memory:

1. Open the **Main Menu**.
2. Press **Events** to open the menu.
3. Press **View Event Memory** to open the menu.

20.2 Clear Event Memory

Use the Clear Event Memory function to clear out event memory without turning your security system off and on again.

Clearing event memory:

1. Open the **Main Menu**.
2. Press **Events** to open the menu.
3. Press **Clear event memory** to open the menu.



20.3 View Log

Use the View Log function to review events stored in your security system. Reviewing past events might help you identify problems. Events are stored in the control panel's memory in order of occurrence, and tagged with the date and time.

Viewing the log:

1. Open the **Main Menu**.
2. Press **Events** to open the menu.
3. Press **View Log** to open the menu. The keypad shows *Enter Start Date*.

To view part of the log, enter the date (MM/DD/YY) at which you wish to start the review. Press **ENTER**.

To view the entire log from the newest event, press **Go to last event** without entering a start date. The date and time of the newest event shows. Use /PREV or /NEXT to move through the events.

4. Escape from the menu.

-Notes-

21 B92x keypad operation overview

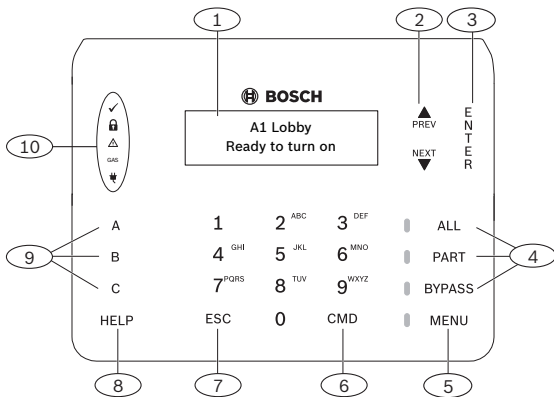

Callout Number	Description
1	Alphanumeric display (refer to <i>Display overview, page 118</i>)
2	PREV and NEXT keys
3	ENTER key
4	ALL , PART , and BYPASS keys
5	MENU key
6	CMD key (Command)

Callout Number	Description
7	ESC key (Escape)
8	HELP key
9	Programmable function keys
10	Status indicators (refer to <i>Status indicators overview, page 119</i>)

Your security system provides quick access to functions through the keypad menus.

To access menus using a B92x, press **MENU**. Press **PREV** or **NEXT** to scroll through the list of functions programmed by your security company. To initiate the function shown on the display, press **ENTER** or press the corresponding number key, as indicated in the on-display instructions (for example, *Press 2 for Status menu*). To exit a specific menu and return to the previous level, press **ESC**. To exit and return to idle text from any level of the menu structure, press and hold **ESC**.

The keypad has a Shortcuts menu to quickly access functions you use most. Your security company programmed these Shortcuts for you. To access Shortcuts, press **MENU**, and then press [6].

My shortcuts are:

21.1 Keys overview

Each keypad has 10 number keys, 7 function keys, and 6 navigation keys. When pressed, keys turn on keypad backlighting and emit the keypress tone (short beep). The function keys include programmable function keys and keys to initiate arming and bypassing with one keypress.

21.1.1 Keys descriptions

MENU

Use the **MENU** key to open the keypad's Main menu. Press **MENU**[6] to access the Shortcuts menu, which is the quickest way to access the functions you use most.

ALL, PART, and BYPASS

Use the **ALL** key to turn your system All On. Use the **PART** key to turn your system Part On. Use the **BYPASS** key to access the menu to bypass points.

ENTER

Use the **BYPASS** key to complete the entry of your passcode other numbers, or to answer Yes to a keypad request.

ESC

The **ESC** (Escape) key has two uses. First, use the **ESC** (Escape) key to exit from menus and functions. Also, use the key as a backspace when you enter names and numbers.

CMD

Use the **CMD** (Command) key in combination with one or two number keys to perform functions.

PREV and NEXT

Use the **PREV** and **NEXT** keys to scroll through menus or menu selections.

21.2 Display overview

The keypad uses words, numbers, and symbols to show the status of the security system. When several events occur, the keypad shows each event in order of priority.

The keypad has a bright two-line liquid crystal display (LCD).

21.3 Status indicators overview

The Status indicators on the keypad provide a quick visual reference for you to see how your system is operating.



Ready to arm. The green checkmark indicates whether the system is ready to turn on (arm).

- ON Steady. All points are normal and the system is ready to turn on.
- OFF. One or more points are faulted, and the system is not ready to turn on.



On (armed). The red lock indicates whether the system is on (armed).

- ON Steady. All areas are on with no alarms.
- Flashing. All areas are armed, and there is an active alarm.
- OFF. One or more areas are off.



Trouble. The yellow caution lights when a trouble condition exists.

- ON Steady. There is a system, device, or point trouble.
- OFF. There are no system, device, or point troubles.



GAS. The blue GAS indicates a gas alarm.

- Flashing. An area has a gas alarm. You should leave the premises immediately when there is a gas alarm.
- OFF. A gas alarm does not exist within the keypad's scope.



Power. The blue power plug whether the control panel has AC power.

- ON Steady. The AC (mains) power to the control panel is present.
- Flashing. AC (mains) power to the control panel is not present and the control panel is operating from the battery.
- OFF. There is no power to the control panel.

22 B91x Keypad operation overview

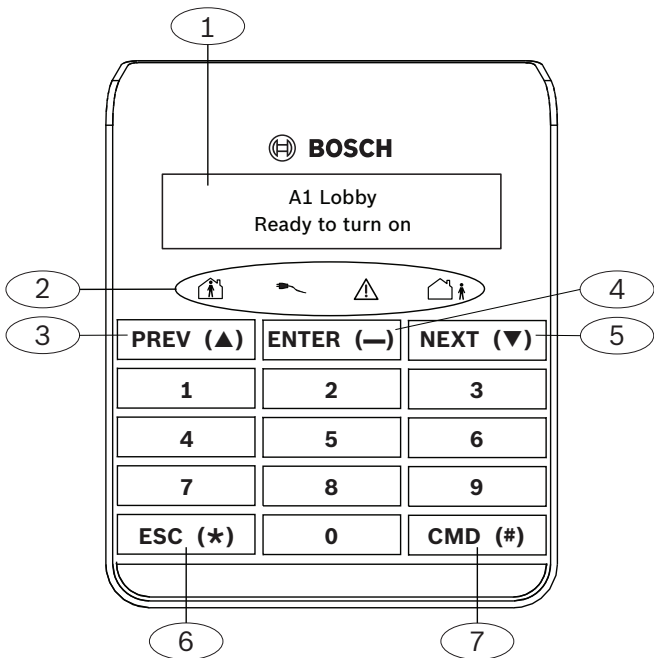

Description of callouts for the keypad overview figure

Callout number	Description	B915 Key	B915I Key
1	Alphanumeric display	n/a	n/a
2	Status icons	n/a	n/a
3	Previous key: use to scroll to previous menu or menu selection.	PREV	[▲]
4	Enter key: use to complete your entry, select a menu item, or answer Yes.	ENTER	[-]
5	Next key: use to scroll to next menu or menu selection.	NEXT	[▼]
6	Escape key: use to exit a menu or function, or to backspace.	ESC	[*]
7	Command key: use with number keys to execute commands (perform functions).	CMD	[#]

Your security system provides quick access to functions through the keypad menus.

To access the main menu, press **CMD**[8]. Press **PREV** or **NEXT** to scroll through the list of functions programmed by your security company. To initiate the function shown on the display, press **ENTER** or press the

corresponding number key, as indicated in the on-display instructions (for example, *Press 2 for Status menu*). To exit a specific menu and return to the previous level, press **ESC**. To exit and return to idle text from any level of the menu structure, press and hold **ESC**.

The keypad has a Shortcuts menu to quickly access functions you use most. Your security company programmed these Shortcuts for you. To access Shortcuts, press **CMD**[8][6].

My shortcuts are:

22.1 Keys overview

Each keypad has 10 number keys and five function keys: **ESC**, **CMD**, **PREV**, **NEXT**, and **ENTER**. When pressed, keys turn on keypad backlighting and emit the keypress tone (short beep).

22.1.1 Keys descriptions

ESC

The **ESC** (Escape) key has two uses. First, use the **ESC** (Escape) key to exit from menus and functions. Also, use the key as a backspace when you enter names and numbers.

CMD

Use the **CMD** (Command) key in combination with one or two number keys to perform functions.

PREV and NEXT

Use the **PREV** and **NEXT** keys to scroll through menus or menu selections.

ENTER

Use the **ENTER** key to complete the entry of your passcode, to select a menu item, or to answer Yes to a keypad request.

22.2 Display overview

The keypad uses words, numbers, and symbols to show the status of the security system. When several events occur, the keypad shows each event in order of priority.

The keypad has a bright two-line liquid crystal display (LCD).

22.3 Status indicators overview

The Status indicators on keypads provide a quick visual reference for you to see how your system is operating.

**Part On status.**

- Green. Ready to turn Part On.
- Red. Part On (part armed).

**Power.** The blue power plug indicates whether the control panel has AC power.

- ON Steady. The AC (mains) power to the control panel is present.
- Flashing. AC (mains) power to the control panel is not present and the control panel is operating from the battery.
- OFF. There is no power to the control panel.

**Trouble.** The yellow caution lights when a trouble condition exists.

- ON Steady. There is a system, device, or point trouble.
- OFF. There are no system, device, or point troubles.

**All On status.**

- Green. Ready to turn All On.
- Red. All On (all armed).

23 B92x/B91x menu tree

The keypad offers an easy-to-use menu tree structure. To access the menu tree, press **MENU** on a B92x or **CMD[8]** on a B91x. Each menu option has a number.

At each level, you can press the number for the desired menu, if you know it. Otherwise, use **PREV** or **NEXT** to review your options at that level, and then press **ENTER** when you see the desired menu option.

The menu tree figure on the next page shows the menu structure and the numbers associated for each menu option.



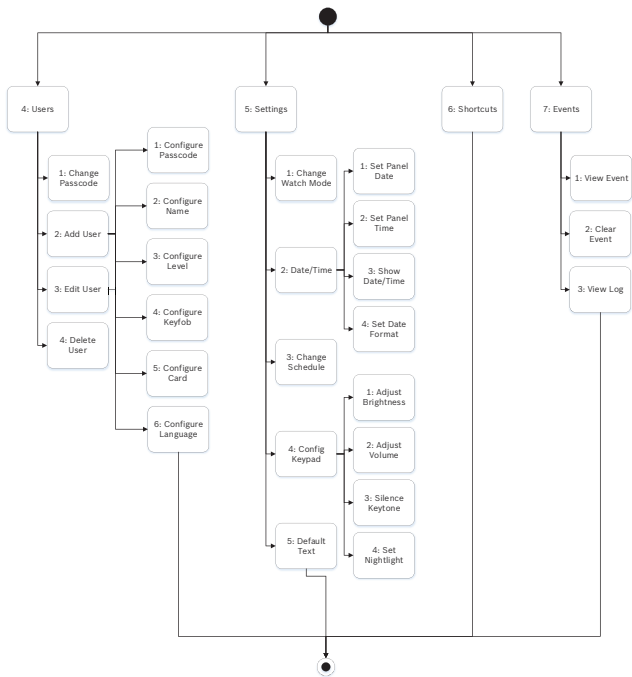



Commands

You can initiate functions with the **CMD** key plus the one or two digit command.

If you know the command number, press the **CMD** key and then the one or two digit command.

**Notice!**

After you press **CMD**, you can use /PREV or /NEXT to move through the list of commands, and press **ENTER** when viewing the desired command.

Review the available commands in the following table.

Command	Function
CMD 0	Bypass
CMD 0 0	Unbypass
CMD 1	All on (with delay)
CMD 1 1	All On, Instant
CMD 2	Part On, Instant
CMD 3	Part On (with delay)
CMD 4*	Silence Trouble Sounders
CMD 4 0	See Alarms
CMD 4 1*	Test Report
CMD 4 2*	Status Report
CMD 4 3*	RPS Answer
CMD 4 4*	Intrusion Walk Test
CMD 4 5*	Change Date and Time
CMD 4 6**	Door Control Menu
CMD 4 7	Reset Sensors
CMD 4 9*	Change Display
CMD 5 0	Go to Area
CMD 5 1	Extend Close

Command	Function
CMD 5 2*	SKED Menu
CMD 5 3	Delete User
CMD 5 4*	Output Change Menu
CMD 5 5	Change Passcode
CMD 5 6	Add User
CMD 5 8*	Fire Walk Test
CMD 5 9	Show Revision
CMD 6	Watch Mode
CMD 7*~	Special Alert _____
CMD 8	Open Main menu
CMD 9*~	Special Alert _____
*Requires firmware v3.0x or higher. #B9512G/B8512G only. ~As configured by your security company.	

24 B92x/B91x On/Off menu

Use the On/Off menu to turn areas All or Part On, to turn areas off, to extend closing time, or to bypass points.

When you turn on (arm) your security system, there is an exit delay that gives you time to leave the area without sounding the burglary tone.

When you enter a security system that is turned on (armed), there is an entry delay that gives you time to turn off (disarm) the system.

24.1 All On menu

Use the All On menu to turn areas All On. Turning an area All On means to turn on (arm) all the points in that area, for example, all doors and all windows and all motion sensors.

24.1.1 All On

Turning an area All On turns on all points in the area and provides entry and exit delay. For example, you can turn on the area and leave through a door (within exit delay time) without creating an alarm event. When you turn the area All On, the display shows how many seconds of exit delay time remain to exit the protected area. Leave before the exit delay time expires.

Leaving after exit delay expires causes entry delay to start. It may also cause an alarm on an interior device. Enter your passcode to turn off the system.

Turning areas All On:

1. Open the **Main Menu**.
2. Press [1] or **ENTER** to open the On/Off menu.
3. Press [1] or **ENTER** to open the All On menu.
4. Press [1] or **ENTER** to select All On Delay.
5. Enter your passcode and press **ENTER**. The keypad shows **Exit Now!** and sounds during the exit delay.
6. Exit the area or enter your passcode to stop the system from turning on. If you turn your system All On and don't exit, the system automatically switches to Part On.

24.1.2 All On Instant

Turning an area All On Instant turns on all points with no entry or exit delay. When areas are All On Instant, faulting any point (opening a door for example) creates an alarm event immediately.

Turning areas All On Instant:

1. Open the **Main Menu**.
2. Press [1] or **ENTER** to open the On/Off menu.
3. Press [1] or **ENTER** to open the All On menu.
4. Use **NEXT** to go to the All On Instant option, and press **ENTER**, or simply press [2]. The keypad shows *All On*.
5. To turn off the security system, enter your passcode and press **ENTER**.

24.1.3 Select Area (All On menu)

Use All On Select to choose individual areas to turn All On or All On Instant. You choose areas from a list of the areas in which you have authority.

Turning on a specific area:

1. Open the **Main Menu**.
2. Press [1] or **ENTER** to open the On/Off menu.
3. Press [1] or **ENTER** to open the All On menu.
4. Use **NEXT** to go to the All On Select menu, and press **ENTER**, or simply press [3].
5. Use **NEXT** and **ENTER** to select either the On Instant or On Delay option. The keypad responds based upon your selection.

24.2 Part On menu

Use the Part On menu to turn areas Part On. Turning an area Part On means to turn on only some of the points, and thus part of the system. For example, your security company might configure your system so that when you use the Part On function, only the exterior doors and windows turn on, whereas interior motion sensors do not turn on.

24.2.1 Part On

Turning an area Part On turns on some points, or part of the system, in the area and provides entry and exit delay. For example, you can turn on the area and leave through a door (within exit delay time) without creating an alarm event.

Turning the perimeter on with an exit delay:

1. Open the **Main Menu**.
2. Press [1] or **ENTER** to open the On/Off menu.
3. Use **NEXT** to go to the Part On option, and press **ENTER**, or simply press [2].
4. Press [1] or **ENTER** to open the Part On Delay option. The keypad shows **Part On Dly**.
5. To turn off the system, enter your passcode and press **ENTER**.

24.2.2 Part On Instant

Turning an area Part On turns on some points, or part of the system, in the area with no entry or exit delay. When the area is Part On Instant, faulting a Part On point (opening a door for example) creates an alarm event immediately.

Turning the system Part On without delay:

1. Open the **Main Menu**.
2. Press [1] or **ENTER** to open the On/Off menu.
3. Use **NEXT** to go to the Part On option, and press **ENTER**, or simply press [2].
4. Use **NEXT** to go to the Part On Instant option, and press **ENTER**, or press [2].
5. Enter your passcode and press **ENTER**. The keypad shows **Part On Inst.**
6. To turn off the system, enter your passcode and press **ENTER**.

24.2.3 Select Area (Part On menu)

Use Part On Select to choose individual areas to turn Part On or Part On Instant. You choose areas from a list of the areas in which you have authority.

Turning individual areas Part On:

1. Open the **Main Menu**.
2. Press [1] or **ENTER** to open the On/Off menu.
3. Use **NEXT** to go to the Part On option, and press **ENTER**, or simply press [2].
4. Use **NEXT** to go to the menu Part On Select menu, and press **ENTER**, or press [3].
5. Use **NEXT** and **ENTER** to select either the On Instant or On Delay option. The keypad responds based upon your selection.

24.3 Off menu

You can turn areas off simply by entering your passcode or by using the Off menu. With either option, you turn off all areas in which you have authority.

You must enter your personal passcode and enter through a designated entry door to prevent an instant alarm condition. Opening the door starts entry delay time and the keypad emits a pulsing “beep” tone to remind you to turn the system off. Enter your passcode before the entry delay time expires.

If you enter through the wrong door or fail to turn off (disarm) before the entry delay time expires, an alarm occurs. If this happens, silence the alarm (by entering your personal passcode and pressing **ENTER**) and call your security company to notify them that you do not have an emergency situation.

Turning off the security system (disarm) with your passcode:

1. Enter your personal passcode.
2. Press **ENTER** within 8 sec of entering your passcode. The display returns to idle text.

24.3.1 Turn Off

You can use the Turn Off menu to turn off all areas in which you have authority.

Turning off areas:

1. Open the **Main Menu**.
2. Press [1] or **ENTER** to open the On/Off menu.

3. Use **NEXT** to go to the menu Off menu, and press **ENTER**, or simply press [3].
4. Press [1] or **ENTER** to open the Off menu.
5. Enter your passcode and press **ENTER**. The display returns to idle text.

24.3.2 Turn Off Select

Use Turn Off Select to choose individual areas to turn off. You choose areas from a list of the areas in which you have authority.

Turning off a specific area:

1. Open the **Main Menu**.
2. Press [1] or **ENTER** to open the On/Off menu.
3. Use **NEXT** to go to the menu Off menu, and press **ENTER**, or simply press [3].
4. Use **NEXT** to go to the menu Turn Off Select menu, and press **ENTER**, or simply press [2].
5. Use **NEXT** and **ENTER** to select an area.
6. Press **ENTER** to turn off your selected area.

24.4 Extend Closing

Your security company might program your system to expect you to turn on (arm) within a closing window. A closing window is a duration of time programmed by your security company. Your security company sets a fixed length of time for the closing window. Additionally, your security company might program your system to automatically turn on (arm) at the end of the window.

Use the Extend Close Time option when you need to stay later than the scheduled close time. If you do not extend the Close Time and do not turn the system on before the scheduled time, the system creates a Late to Close event.

At the beginning of the closing window, the keypad beeps and shows **Please Close Now** to remind you to turn on (arm) your system. It remains in the display until you turn on the system, the close window ends, or you extend closing. Alarm or trouble messages replace this message in the event of an alarm or trouble condition. If the alarm or trouble condition clears before the end of the close window **Please Close Now** returns to the keypad display.

Pressing **ESC** silences the beep and clears the message for 10 minutes. If you have not turned your system on (armed) or extended closing, the **Please Close Now** message and beep reappear after 10 minutes. To extend the window, enter the new time at which you would like the reminder tone to begin. This time is the new beginning of the closing window.

When you hear the warning, you can:

- Leave before the end of the closing window by pressing **ESC** to silence the signal, turning on the system, and leaving.
- Stay past the scheduled end of the closing window, by using this function to extend the closing window.

To extend closing:

1. Open the **Main Menu**.
2. Press [1] or **ENTER** to open the On/Off menu.
3. Use **NEXT** to go to the Extend Closing menu, and press **ENTER**, or simply press [4].
4. Enter your passcode and press **ENTER**.



Notice!

You cannot extend the window across the midnight boundary. The system cannot arm if points are off-normal.

24.5 Bypass menu

Use the Bypass menu to temporarily take points out of the security system, and enter them back into the system. Bypassed points do not create alarm or trouble events, do not detect intruders, and cannot send any reports. For example, to leave a window open and turn the system on, you bypass the window point and then turn the system on.

24.5.1 Bypass

You can bypass points when an area is turned off (disarmed). Points remain bypassed until you unby pass them or some points return when the area is turned off (disarmed). Use point bypassing with discretion: bypassing a point reduces the level of security.

Bypassing a point:

1. Open the **Main Menu**.
2. Press [1] or **ENTER** to open the On/Off menu.
3. Use **NEXT** to go to the Bypass menu, and press **ENTER**, or simply press [5].
4. Press [1] or **ENTER** to open the Bypass Points menu.
5. Select a point to bypass.
6. Press **ESC** to exit the menu.

24.5.2 Unbypass

Unbypassing a point returns a bypassed point to the security system so that it can once again respond to trouble and alarm conditions.

Unbypassing a point:

1. Open the **Main Menu**.
2. Press [1] or **ENTER** to open the On/Off menu.
3. Use **NEXT** to go to the Bypass menu, and press **ENTER**, or simply press [5].
4. Use **NEXT** to go to the Unbypass menu, and press **ENTER**, or simply press [2].
5. Enter your passcode and press **ENTER**.
6. Select a point to bypass.
7. Press **ESC** to exit the menu.

25 B92x/B91x Status menu

Use the Status menu to see area or point status, or to send a status report.

25.1 View Area Status

Area Status shows the on/off status for areas in which you have authority.

Viewing area status:

1. Open the **Main Menu**.
2. Use **NEXT** to go to the Status menu option, and press **ENTER**, or simply press [2].
3. Press [1] or **ENTER** to open the View Area Status menu.
4. Enter your passcode and press **ENTER**. The display shows the status of each area. For example *A1: Off*.
5. Press **ESC** to exit the menu.

25.2 View Point Status

The View Point Status feature shows the status (normal, open, or short) for all points in the areas in which you have authority.

Viewing point status:

1. Open the **Main Menu**.
2. Use **NEXT** to go to the Status menu option, and press **ENTER**, or simply press [2].
3. Use **NEXT** to go to the View Point Status menu option, and press **ENTER**, or simply press [2].
4. The display shows the number of points in the system. Use **PREV** or **NEXT** to scroll through the list of points and each point's status.
5. Press **ESC** to exit the menu.

25.3 Send Status Report

The Send Status Report feature sends a complete system status report to your security monitoring company. Status reports can alert them to potential problems.

Sending a status report:

1. Open the **Main Menu**.
2. Use **NEXT** to go to the Status menu option, and press **ENTER**, or simply press [2].
3. Use **NEXT** to go to the Send Status Report menu option, and press **ENTER**, or simply press [3].
4. Enter your passcode and press **ENTER**. The control panel sends a status report to your security company.

26 B92x/B91x Actions menu

Use the Actions menu to reset sensors, change outputs, see the test menu, see the RPS menu, go to an area, update system firmware, or to view service bypassed points.

26.1 Reset

Detection devices, such as smoke detectors and shock sensors, might require a reset action before they return to normal operation. This function momentarily removes power from these devices to reset them.

Resetting sensors:

1. Open the **Main Menu**.
2. Use **NEXT** to go to the Actions menu option, and press **ENTER**, or simply press [3].
3. Press [1] or **ENTER** to reset the sensors with the Reset option.
4. Enter your passcode and press **ENTER**. The display shows **Sensors resetting Please wait...** for approximately 3 seconds and then goes blank before returning to idle disarmed text.

If you enter this function and the detector or sensor resets momentarily, but then returns to a faulted condition, the conditions causing the activation may still be present or the detector may be faulty. Check to be certain that there is no smoke, fire, or other danger present.

If you cannot reset the detector or sensor, contact your security company.

26.2 Outputs

Your security company programs outputs for automatic control and/or keypad control of devices such as premises lighting or entry gates. An output is a device that is controlled by the security system. Contact your security company for further information regarding the use of outputs in your security system.

Use this function to select outputs to turn on or off. Outputs on your security system can control other systems, lighting for example.

Security systems using B5512/B4512/B3512 control panels are not UL investigated for access control.

Turning outputs on and off:

1. Open the **Main Menu**.
2. Use **NEXT** to go to the Actions menu option, and press **ENTER**, or simply press [3].
3. Use **NEXT** to go to the Outputs menu option, and press **ENTER**, or simply press [2].
4. Enter your passcode and press **ENTER**.
5. Use **NEXT** to select the desired output value, or use the number keys to enter the value.
6. Press **ENTER** The current state of the output shows.
7. Use **ENTER** to toggle between *Off* and *On*.
8. Press **ESC** to exit the menu.

26.3 Test

Use the Test menu to walk test your system, send test reports, or to review system revision information on the keypad display.

26.3.1 Walk Test

A walk test allows you to test the sensors, keypads, sounders, and other devices in your system without creating alarm events. You can review untested points at the keypad to help pinpoint any problems.

You cannot turn on the security system while in the walk test mode. Also, the security system does not create alarm events for points included in the walk test. Points not included create alarm events. For example, faulting a fire point during an intrusion walk test creates a fire alarm event.

Beginning the walk test activates the burglary tone for 2 seconds. A battery test also begins. A successful battery test ends in four minutes (the walk test continues). If the security system determines there is a low battery, it generates a low battery event and continues the test. If the battery is determined to be very low, the system creates a missing battery event and ends the battery test immediately.

To test individual detection devices, simply activate sensors and open protected doors and windows one-at-a-time. As you fault each detection device, the keypad from which you initiated the test emits a brief tone, and for 60 seconds the display indicates that the point was tested. The tone and display verify that each detection device is working properly. Keypads within the area's scope from which you did not initiate the walk test show *Walk test in progress* during the testing.



Notice!

Fire walk test includes gas

When you perform a Fire walk test, the security system tests any 24-hour points that are not invisible, including gas points.

Performing a walk test:

1. Open the **Main Menu**.
2. Use **NEXT** to go to the Actions menu option, and press **ENTER**, or simply press [3].
3. Use **NEXT** to go to the Test menu option, and press **ENTER**, or simply press [3].
4. Press [1] or **ENTER** to open the Walk Test menu.
5. Enter your passcode and press **ENTER**.
6. Use **NEXT** to go to the desired walk test, and press **ENTER**, or simply press the number key for the desired walk test: [1] for Fire, [2] for Intrusion, [3] for Service, or [4] for Invisible.
7. Press **ENTER** to view the points.
8. Use **NEXT** to toggle through your desired point and view the status of that point.
9. Press **ESC** to exit the menu.

Automatic termination

The Walk Test automatically ends after 20 minutes of no test activity. The keypad sounds during the last 5 minutes of the test.

26.3.2 Send Test Report

This function tests the communication link between your security system and your security company. It is an important part of maintaining a high level of security for your property.

You can either send a normal test report or a custom test report:

- Normal test report: Includes all route groups that have the test report function enabled, independent of which destination device is used to communicate. The test report is sent to the first successful destination device in a route group.
- Custom test report: You can select the route group and destination device you want to test. You can either test one destination device per route group or all configured destination devices for a route group.

Sending a normal test report:

1. Open the **Main Menu**.
2. Use **NEXT** to go to the Actions menu option, and press **ENTER**, or press [3].
3. Use **NEXT** to go to the Test menu option, and press **ENTER**, or press [3].
4. Use **NEXT** to go to the Test Report menu option, and press **ENTER**.
5. Use **NEXT** to go to the **Normal Test** menu option, and press **ENTER**.
6. Enter your passcode and press **ENTER**.
The system sends a normal test report.
7. Press **ESC** to exit the menu

Sending a custom test report:

1. Open the **Main Menu**.
2. Use **NEXT** to go to the Actions menu option, and press **ENTER**, or press [3].

3. Use **NEXT** to go to the Test menu option, and press **ENTER**, or press [3].
4. Use **NEXT** to go to the Test Report menu option, and press **ENTER**.
5. Use **NEXT** to go to the **Custom Test** menu option, and press **ENTER**.
6. Select the route group you want to test.
7. Select the destination you want to test or select all destinations.
8. Enter your passcode and press **ENTER**.
The system sends a custom test report.
9. Press **ESC** to exit the menu

26.3.3 Revisions

Use this function to view the current revision of your control panel firmware.

Viewing the current revision of your system (control panel):

1. Open the **Main Menu**.
2. Use **NEXT** to go to the Actions menu option, and press **ENTER**, or simply press [3].
3. Use **NEXT** to go to the Test menu option, and press **ENTER**, or simply press [3].
4. Use **NEXT** to go to the Revisions menu option, and press **ENTER**, or simply press [3]. The current control panel revision information shows on the display.
5. Press **ESC** to exit the menu.

26.3.4 Notification Test

Use this menu to test the security system's ability to send personal notification messages to the destination path designated by your security company.

Testing notifications:

1. Open the **Main Menu**.
2. Use **NEXT** to go to the Actions menu option, and press **ENTER**, or simply press [3].
3. Use **NEXT** to go to the Test menu option, and **ENTER**, or simply press [3].
4. Use **NEXT** to go to the Notification Test Report option, and press **ENTER**, or simply press [4]. The keypad shows the first destination.
5. Use **NEXT** to go to the desired destination, and then press **ENTER**. The control panel sends a test notification, and then returns to idle text.

26.4 RPS

Use the RPS menu for connection to Remote Programming Software (RPS). Your security company uses RPS to configure and service your security system. RPS is intended for use by professional or licensed installers only.

26.4.1 Answer

Use the Answer option to answer the phone (pick up the phone line) to connect to RPS.

Using the Answer menu option to answer an incoming call from RPS:

1. Open the **Main Menu**.

2. Use **NEXT** to go to the Actions menu option, and press **ENTER**, or simply press [3].
3. Use **NEXT** to go to the RPS menu option, and press **ENTER**, or simply press [4].
4. Press [1] or **ENTER** to reset the sensors with the Answer option.
5. Enter your passcode and press **ENTER**. The keypad shows *RPS is connecting....* and then returns to idle text.

26.4.2 Network Originate

Use this function to originate an RPS session using an internet connection.

Connecting to RPS using an internet connection:

1. Open the **Main Menu**.
2. Use **NEXT** to go to the Actions menu option, and press **ENTER**, or simply press [3].
3. Use **NEXT** to go to the RPS menu option, and press **ENTER**, or simply press [4].
4. Use **NEXT** to go to the Network Originate menu option, and press **ENTER**, or simply press [2].
5. Enter your passcode and press **ENTER**.
6. To use the programmed port number, press [1] or press **ENTER**. The connection progress begins.
7. If you wish to change the port number before connecting, press **NEXT** and then **ENTER**, or simply press [2]. The **ESC** key acts as a backspace key. Press **ESC** to delete the characters, and then enter the new characters. Press **ENTER**. The connection process begins.

26.4.3 Call Via Phone

Use this function to call RPS using the phone line.

Connecting to RPS via the phone line:

1. Open the **Main Menu**.
2. Use **NEXT** to go to the Actions menu option, and press **ENTER**, or simply press [3].
3. Use **NEXT** to go to the RPS menu option, and press **ENTER**, or simply press [4].
4. Use **NEXT** to go to the Call Via Phone menu option, and press **ENTER**, or simply press [3].
5. Enter your passcode and press **ENTER**. The connection process begins.

26.5 Go to Area

With the Go to Area function you can perform tasks in an area other than the one you're in without having to physically go to that area. For example, using the keypad in the office area, you could 'go' to the loading area. You select the area from a list of areas in which you have authority.

Once you 'go' to an area, you can perform tasks you have authority for in that area. To 'leave' an area press [ESC].

Using Go to Area:

1. Open the **Main Menu**.
2. Use **NEXT** to go to the Actions menu option, and press **ENTER**, or simply press [3].
3. Use **NEXT** to go to the Go to Area menu option, and press **ENTER**, or simply press [5].
4. Enter your passcode and press **ENTER**.

5. Use **NEXT** to go to the area you wish to enter, and then press **ENTER**.

26.6 Firmware

Your security company might have configured your security system to require your authorization before system firmware can be updated. Use this action to provide authorization at the request of your security company. Local authorization is required for UL listed systems.

Authorizing a firmware update:

1. Open the **Main Menu**.
2. Use **NEXT** to go to the Actions menu option, and press **ENTER**, or simply press [3].
3. Use **NEXT** to go to the Firmware menu option, and **ENTER**, or simply press [6].
4. Enter your passcode and press **ENTER**.

26.7 Service Bypass

To facilitate system maintenance for service personnel, your security system comes with a special point bypass option to remove any point from service. Bypassed points are not protected. Use this menu to view bypassed points.

Viewing points in Service Bypass:

1. Open the **Main Menu**.
2. Use **NEXT** to go to the Actions menu option, and press **ENTER**, or simply press [3].
3. Use **NEXT** to go to the Service Bypass menu option, and press **ENTER**, or simply press [6].
4. Enter your passcode and press **ENTER**. The keypad shows any points in service bypass.

26.8 Access menu

Use the Access menu to control doors.

When you open Access menu options and the desired door number, the keypad shows the door state.

State	Meaning
Cycling	The cycle door function is running (door can be opened during the cycle function).
Unlocked	The door is unlocked (you do not need to activate a door request or present a valid credential).

State	Meaning
Secure	The door is secured (door cannot be opened when secured, even if you present a valid credential).
Fail	The door is in a failed state. Call your security company.
Locked	The door is locked (door can be opened by presenting a valid credential).

This feature is:

available on my system.

unavailable on my system.

26.8.1 Cycle Door

Use the Cycle Door menu to allow access during the cycle time (door can be opened).

Cycling a door:

1. Open the **Main Menu**.
2. Use **NEXT** to go to the Actions menu option, and press **ENTER**, or simply press [3].
3. Use **NEXT** to go to the Access menu option, and press **ENTER**, or simply press [8].
4. Press the [1] or **ENTER** to open the Cycle Door option.
5. Enter your passcode and press the **ENTER** key.
6. Use **PREV** or **NEXT** to scroll to the desired door. The keypad shows the door status.
7. To cycle the door, press **ENTER**. The door cycles.
8. Escape from the menu.

26.8.2 Unlock Door

Use the Unlock Door menu to unlock a door to allow free access.

Unlocking a door:

1. Open the **Main Menu**.
2. Use **NEXT** to go to the Actions menu option, and press **ENTER**, or simply press [3].
3. Use **NEXT** to go to the Access menu option, and press **ENTER**, or simply press [8].
4. Use **NEXT** to go to the Unlock menu option, and press **ENTER**, or simply press [2].
5. Enter your passcode and press **ENTER**.
6. Use **PREV** or **NEXT** to scroll to the desired door. The keypad shows the door status.
7. Press **ENTER**. The door unlocks.
8. Escape from the menu.

26.8.3 Lock Door

Use the Lock Door menu to lock an unlocked door. Also use this menu to lock doors that were automatically opened during a fire alarm. Once a door is locked, a user must present a card to enter, or send an Unlock or a Cycle command from the keypad to allow the door to open.

Locking a door:

1. Open the **Main Menu**.
2. Use **NEXT** to go to the Actions menu option, and press **ENTER**, or simply press [3].
3. Use the **NEXT** key to go to the Access menu option, and press **ENTER**, or simply press [8].
4. Use **NEXT** to go to the Lock menu option, and press **ENTER**, or simply press [3].
5. Enter your passcode and press **ENTER**.
6. Use **PREV** or **NEXT** to scroll to the desired door. The keypad shows the door status.
7. Press **ENTER**. The door locks.
8. Escape from the menu.

26.8.4 Secure Door

Use the Secure Door menu to secure and unsecure doors. A secured door cannot be opened by presenting a valid credential or by using the cycle function.

Securing a door:

1. Open the **Main Menu**.
2. Use **NEXT** to go to the Actions menu option, and press **ENTER**, or simply press [3].
3. Use the **NEXT** key to go to the Access menu option, and press **ENTER**, or simply press [8].
4. Use **NEXT** to go to the Secure menu option, and press **ENTER**, or simply press [4].
5. Enter your passcode and press **ENTER**.
6. Use **PREV** or **NEXT** to scroll to the desired door. The keypad shows the door status.
7. Press **ENTER**. The door secures.
8. Escape from the menu..

27 B92x/B91x Users menu

Use the Users menu to change your own passcode, add new users, edit existing users, or to delete users.

27.1 Change Passcode

Use the Change Passcode function to change your personal passcode. Before you begin, consider the following:

- Choose a new passcode three to six digits long. If you choose a passcode with the same digit in consecutive order (for example “33” in 334697), take care when entering it.
- To avoid conflicting with other passcodes and duress codes, your security system does not let you change to existing passcodes or passcodes that are within plus or minus 2 of an existing passcode. For example, if 1234 is an existing code, your security system does not let you change your code to 1232, 1233, 1234, 1235, or 1236.

Changing your passcode:

1. Open the **Main Menu**.
2. Use **NEXT** to go the Users menu option, and press **ENTER**, or simply press [4].
3. Press [1] or **ENTER** to open the Change Passcode option.
4. Enter your current passcode and press **ENTER**.
5. Enter your new passcode and press **ENTER**.
6. Enter your new passcode again and press **ENTER**. The keypad shows **Passcode changed** and then returns to the Change Passcode option.
7. Press **ESC** to exit the menu.

27.2 Add User

Use the Add User function to add a passcode to your security system. Before you add the user, you need to know which user numbers are available, the authority level you want to assign to the new passcode, and the areas in which it will be valid.

The user numbers identify users in reports transmitted from your security system. The authority level determines what system functions the passcode can access. The area number identifies which parts of your security system the passcode can access. Contact your security company if you don't know what user numbers, authority levels, or areas are available.

Before you begin:

- Do not try to add passcodes without knowing the available user numbers. These numbers are not to be confused with passcodes that identify users at your security company.
- Choose a new passcode three to six digits long. If you choose a passcode with the same digit in consecutive order (for example “33” in 334697), take care when entering it.
- To avoid conflicting with other passcodes and duress codes, your security system does not let you add passcodes that are within plus or minus 2 of an existing passcode. For example, if 1234 is an existing code, your system does not let you change your code to 1232, 1233, 1235, or 1236.
- Choose an authority level for each area. Leaving the authority level for an area blank by pressing **ENTER** without making an entry, denies the passcode access to that area.

Adding a user:

1. Open the **Main Menu**.
2. Use **NEXT** to go the Users menu option, and press **ENTER**, or simply press [4].
3. Use **NEXT** to go to the Add User menu option, and press **ENTER**, or simply press [2].
4. Enter your passcode and press **ENTER**.
5. Enter the number (1 - 50) for the user you wish to add, and press **ENTER**.

Configuring the user's passcode:

1. Press [1] or **ENTER** to open the Configure Passcode menu.
2. Press **ENTER** to configure the user's passcode.
3. Enter the user's passcode and press **ENTER**.
4. Enter the passcode again and press **ENTER**. The keypad shows **Passcode changed** and then returns to the previous menu.

Configuring the user's name:

1. Use **NEXT** to go to the Configure Name option, and press **ENTER**, or simply press [2].
2. Press **ENTER** to configure the user's name.
3. The **ESC** key acts as a backspace key. Press **ESC** to delete the characters. Press a number key repeatedly to scroll through the number and letters shown on the key. To enter a space, press [0] [0]. To enter a space, press [0][0]. To capitalize a letter, press **CMD** before you enter the letter. For caps lock, press **CMDCMD**. To remove caps lock, press **CMDCMDCMD**.
4. Press **ENTER** to save the new name. The keypad returns to the previous menu.

Configuring the user's level:

1. Use **NEXT** to go to the Configure Level option, and press **ENTER**, or simply press [3].
2. Press **ENTER** to change the default authority level for area 1.
3. Enter the authority level number (1 - 14) you wish to apply to the user and press **ENTER**. The keypad shows **Level configured** and returns to the previous menu.
4. If your security system has more than one area, use **NEXT** and the previous two steps to set the levels for the additional areas.

Configuring a RADION keyfob or an Inovonics Transmitter for the user:

1. Use **NEXT** to go to the Configure Keyfob option, and press **ENTER**, or simply press [4].
2. Press **ENTER** to continue.
3. To manually enter the RFID, if desired, press [1] or **ENTER** to open the RFID option. Otherwise, the keypad automatically learns the RFID into the security system when you add a RADION keyfob or an Inovonics Transmitter.
4. Press **ENTER** to continue.
5. Enter the RFID.
6. Press **ENTER** to save the RFID and return to the previous menu.
7. Use **NEXT** to go to the Add a Keyfob option, and press **ENTER** or simply press [2].
8. Press **ENTER** to continue.
9. On a RADION keyfob, press any button on the keyfob. On an Inovonics Transmitter, open the transmitter and press the RESET button, per the manufacturer's instructions. The keypad shows *Keyfob enrolled* and returns to the previous menu.
10. If you need to replace the keyfob or transmitter you just added (for example, you accidentally added the wrong one), use **NEXT** to go to the Replace a Keyfob option, and press **ENTER**, or simply press [3], and then follow the previous step.
11. To remove the added keyfob or transmitter, use **NEXT** to go to the Remove a Keyfob option, and press **ENTER** or simply press [4].
12. Press **ESC** to exit the menu.

Configuring a card for a user:

1. Use **NEXT** to go to the Configure Card option, and press **ENTER**, or simply press [5].
2. Press **ENTER** to continue. The keypad shows *Present card*.

3. Present the card at the reader.
4. If the reader identifies the card, the keypad shows **Card configured**.
5. Press **ESC** to exit the menu.

This feature is:



available on my system.



unavailable on my system.

Selecting a keypad display language for the user:

1. Use **NEXT** to go to the Configure Language option, and press **ENTER**, or simply press [6].
2. Press **ENTER** to continue.
3. Press **ENTER** to change the language. The keypad shows **Language configured**, and then returns to the previous menu.

This feature is:



available on my system.



unavailable on my system.

Enabling and disabling for mobile app connectivity for the user:

1. Use **NEXT** to go to the Configure Mobile App option, and press **ENTER**, or simply press [7].
2. Press **ENTER** to continue. The current state (enabled/disabled) shows.
3. Press **ENTER** to change the setting. The keypad indicates the new configuration, and then returns to the previous menu.

27.3 Edit User

Use the Edit User function to edit a user of your security system. You need to know the user number for the user you want to edit.

Editing an existing user:

1. Open the **Main Menu**.
2. Use **NEXT** to go to the Users menu option, and press **ENTER**, or simply press [4].
3. Use **NEXT** to go to the Edit User menu option, and press **ENTER**, or simply press [3].
4. Enter your passcode and press **ENTER**.
5. Enter the number (1 - 50) for the user you wish to edit, and press **ENTER**.
6. The keypad shows the name for the user number you entered. Press **ENTER**.

Configuring the user's passcode:

1. Press [1] or **ENTER** to open the Configure Passcode menu.
2. Press **ENTER** to configure the user's passcode.
3. Enter the user's passcode and press **ENTER**.
4. Enter the passcode again and press **ENTER**. The keypad shows **Passcode changed** and then returns to the previous menu.

Configuring the user's name:

1. Use **NEXT** to go to the Configure Name option, and press **ENTER**, or simply press [2].
 2. Press **ENTER** to configure the user's name.
 3. The **ESC** key acts as a backspace key. Press **ESC** to delete the characters. Press a number key repeatedly to scroll through the number and letters shown on the key. To enter a space, press [0]
-

[0]. To enter a space, press [0][0]. To capitalize a letter, press **CMD** before you enter the letter. For caps lock, press **CMDCMD**. To remove caps lock, press **CMDCMDCMD**.

4. Press **ENTER** to save the new name. The keypad returns to the previous menu.

Configuring the user's level:

1. Use **NEXT** to go to the Configure Level option, and press **ENTER**, or simply press [3].
2. Press **ENTER** to change the default authority level for area 1.
3. Enter the authority level number (1 - 14) you wish to apply to the user and press **ENTER**. The keypad shows **Level configured** and returns to the previous menu.
4. If your security system has more than one area, use **NEXT** and the previous two steps to set the levels for the additional areas.

Configuring a RADION keyfob or an Inovonics Transmitter for the user:

1. Use **NEXT** to go to the Configure Keyfob option, and press **ENTER**, or simply press [4].
2. Press **ENTER** to continue.
3. To manually enter the RFID, if desired, press [1] or **ENTER** to open the RFID option. Otherwise, the keypad automatically learns the RFID into the security system when you add a RADION keyfob or an Inovonics Transmitter.
4. Press **ENTER** to continue.
5. Enter the RFID.
6. Press **ENTER** to save the RFID and return to the previous menu.
7. Use **NEXT** to go to the Add a Keyfob option, and press **ENTER** or simply press [2].
8. Press **ENTER** to continue.
9. On a RADION keyfob, press any button on the keyfob. On an Inovonics Transmitter, open the transmitter and press the RESET button, per the manufacturer's instructions. The keypad shows *Keyfob enrolled* and returns to the previous menu.
10. If you need to replace the keyfob or transmitter you just added (for example, you accidentally added the wrong one), use **NEXT** to go to the Replace a Keyfob option, and press **ENTER**, or simply press [3], and then follow the previous step.
11. To remove the added keyfob or transmitter, use **NEXT** to go to the Remove a Keyfob option, and press **ENTER** or simply press [4].
12. Press **ESC** to exit the menu.

Adding or replacing a card for the user:

1. Use **NEXT** to go to the Configure Card option, and press **ENTER**, or simply press [5].
2. Press **ENTER** to continue. The keypad shows *Present card*.

3. Present the card at the card reader.
4. If the reader identifies the card, the keypad shows **Card configured**.
5. Press **ESC** to exit the menu.

This feature is:



available on my system.



unavailable on my system.

Selecting a keypad display language for the user:

1. Use **NEXT** to go to the Configure Language option, and press **ENTER**, or simply press [6].
2. Press **ENTER** to continue.
3. Press **ENTER** to change the language. The keypad shows **Language configured**, and then returns to the previous menu.

This feature is:



available on my system.



unavailable on my system.

Enabling and disabling for mobile app connectivity for the user:

1. Use **NEXT** to go to the Configure Mobile App option, and press **ENTER**, or simply press [7].
2. Press **ENTER** to continue. The current state (enabled/disabled) shows.
3. Press **ENTER** to change the setting. The keypad indicates the new configuration, and then returns to the previous menu.

27.4 Delete User

Use the Delete User function to delete a user.

Use this function to remove users from the system. All user data (name, passcode, keyfob) is deleted and cannot be recovered. Use Edit User if you only wish to remove a user's authority (disable the user), but retain the user's data. You need to know the user number for the passcode you want to delete. The user numbers identify users in reports transmitted from your system.

Deleting a user:

1. Open the **Main Menu**.
2. Use **NEXT** to go to the Users menu option, and press **ENTER**, or simply press [4].
3. Use **NEXT** to go to the Delete User menu option, and press **ENTER**, or simply press [4].
4. Enter your passcode and press **ENTER**.
5. Enter the number for the user you wish to delete, and press **ENTER**.
6. Press **ENTER** to continue.
7. Press **ENTER** to confirm you wish to delete the selected user. The keypad shows *User ## deleted*, and then returns to the previous menu.
8. Press **ESC** to exit the menu.

28 B92x/B91x Settings menu

Use the Settings menu to turn Watch mode on or off, set the system date and time, view and change schedules, set keypad brightness and volume, and show the time in the keypad display.

28.1 Watch Mode

You can use Watch Mode to monitor select points with the security system turned off. Each time points are faulted (door or window is opened), the keypad chimes once and shows the point text for 60 seconds. The control panel does not generate alarms in this mode except 24-hour alarms (fire, panic, etc.).

Use this function in residential systems to monitor entries or exits in your home. In commercial systems it can serve as a door chime to alert you when a customer or delivery person enters your business.

Entering and exiting Watch Mode:

1. Open the **Main Menu**.
2. Use **NEXT** to go to the Settings menu option, and press **ENTER**, or simply press [5].
3. Press [1] or **ENTER** to open the Watch Mode option.
4. Enter your passcode and press **ENTER**.
5. Press **ENTER** to turn Watch Mode on if it is off, or off if it is on. The keypad display indicates that you enabled or disabled Watch Mode successfully.
6. Press **ESC** to exit the menu.

28.2 Date/Time

Your security system must have the correct time and date for scheduled events to occur at the correct times. Use the Date/Time function to set both the time and date. The security system uses a 12-hour AM/PM format or a 24 hour format (select in the Date format menu option).

If your security system is configured for automatic date/time updates, the update might overwrite your changes.

Setting the date and time:

1. Open the **Main Menu**.
2. Use **NEXT** to go to the Settings menu option, and press **ENTER**, or simply press [5].
3. Use **NEXT** to go to the Date/Time menu option, and press **ENTER**, or simply press [2].
4. Press [1] or **ENTER** to set the control panel's date.
5. Enter your passcode and press **ENTER**.
6. Enter the new date in the selected format. If you make a mistake, the **ESC** key acts as a backspace key. Press **ESC** to delete the characters and then enter the new numbers.
7. Press **ENTER**. The keypad shows **Change complete** and then returns to the previous menu.
8. Use **NEXT** to go to the option to change the time, and press **ENTER**, or simply press [2].
9. Enter the new time in the selected format. If you make a mistake, the **ESC** key acts as a backspace key. Press **ESC** to delete the characters and then enter the new numbers.

10. Press **ENTER** to save the time. For 24 hour format systems, the keypad shows **Change complete** and then returns to the previous menu. For 12 hour format systems, the keypad shows the AM or PM selection option. Follow the prompts to select a format and return to the previous menu.
11. Press **ESC** to exit the menu.

28.3 Schedule (SKEDs)

A SKED is a function programmed to be performed automatically at a scheduled time by your security system. You can change the scheduled time for SKEDs, disable a SKED to prevent it from automatically happening, or restart a previously disabled SKED. Contact your security company to determine what SKEDs they programmed for your system.

Selecting a SKED to change:

1. Open the **Main Menu**.
2. Use **NEXT** to go to the Settings menu option, and press **ENTER**, or simply press [5].
3. Use **NEXT** to go to the Schedule menu option, and **ENTER**, or simply press [3].
4. Enter your passcode and press **ENTER**.
5. Use **PREV** or **NEXT** to scroll through the list of SKEDs. The keypad indicates whether a SKED is enabled, disabled, or not yet programmed.
6. With the SKED you wish to enable showing, press **ENTER**.
7. Continue to *Enabling a disabled SKED* or *Disabling a enabled SKED*.

Enabling a disabled SKED:

1. With the SKED you wish to enable showing, press **ENTER**.
2. Press **ENTER** to continue.
3. Enter the new time in HH:MM format. If you make a mistake the **ESC** key acts as a backspace key. Press **ESC** to delete the characters and then enter the new numbers.
4. Press **ENTER** to save the time and choose AM or PM.
5. Press **ENTER** to select AM, or press **NEXT** and then **ENTER** to select PM. The keypad shows *Schedule update complete* and then returns to the previous menu.
6. Press **ESC** to exit the menu.

Disabling an enabled SKED:

1. With the SKED you wish to enable showing, press **ENTER**.
2. Press **ENTER**.to continue disable it. The keypad display indicates that the SKED is disabled.
3. Press **ESC** to exit the menu.

28.4 Keypad

Use the Keypad menu to adjust the brightness of the keypad display, the keypress volume, and enable or disable the keypress tone.

28.4.1 Brightness

Use the Brightness function to adjust the brightness level for the keypad display.

Adjusting the keypad display brightness:

1. Open the **Main Menu**.
2. Use **NEXT** to go to the Settings menu option, and press **ENTER**, or simply press [5].
3. Use **NEXT** to go to the Keypad menu option, and press **ENTER**, or simply press [4].
4. Press [1] or **ENTER** to adjust the brightness.
5. Press **PREV** or **NEXT** to adjust the brightness level. The changes apply immediately.
6. Press **ESC** to exit the menu.

28.4.2 Volume

Use the Volume function to adjust the keypress volume level for the keypad.

Adjusting the keypress volume:

1. Open the **Main Menu**.
2. Use **NEXT** to go to the Settings menu option, and press **ENTER**, or simply press [5].
3. Use **NEXT** to go to the Keypad menu option, and press **ENTER**, or simply press [4].
4. Use **NEXT** to go to the Volume menu option, and press **ENTER**, or simply press [2].
5. Press **PREV** or **NEXT** to adjust the volume level. The changes apply immediately.
6. Press **ESC** to exit the menu.

28.4.3 Keypress

Use the Keypress function to activate or deactivate the keypress tone.

Activating and deactivating the keypress tone:

1. Open the **Main Menu**.
2. Use **NEXT** to go to the Settings menu option, and press **ENTER**, or simply press [5].
3. Use **NEXT** to go to the Keypad menu option, and press **ENTER**, or simply press [4].
4. Use **NEXT** to go to the Keypress menu option, and press **ENTER**, or simply press [3].
5. Press **ENTER** to toggle between the *On* and *Off* options.
6. Press **ESC** to exit the menu.

28.4.4 Nightlight

Use the Nightlight menu to turn the nightlight feature on or off. The nightlight feature dimly lights the display and keys when the keypad is idle, making it easier to find the keypad in a dark room.

Turning the nightlight feature on or off:

1. Open the **Main Menu**.
2. Use **NEXT** to go to the Press 5 for Settings Menu option, or simply press [5].
3. Use **NEXT** to go to the Press 4 for Keypad Config option, or simply press [4].
4. Use **NEXT** to go to the Press 4 to Set Nightlight option, or simply press [4].
5. Use **PREV** or **NEXT** to toggle between the Yes and No options.
6. Press **ENTER** while viewing the desired option to save the programming.

7. Press **ESC** to exit the menu.

29 B92x/B91x Shortcuts menu

Use shortcuts to quickly access common functions.

Using a shortcut:

1. Open the **Main Menu**.
2. Use **NEXT** to go to the Shortcuts menu option, and press **ENTER**, or simply press [6].
3. Use **PREV** or **NEXT** to go to the Shortcut you wish to run, and then press **ENTER**. The shortcut runs.

30 B92x/B91x Events menu

Use the Events menu to view event memory, clear event memory, or view the event log.

30.1 View Event Memory

Your security system stores events that occurred since the last time memory was cleared. Use View Event Memory to view the events not previously cleared. Each time you turn the security system on, the event memory is erased.

Viewing event memory:

1. Open the **Main Menu**.
2. Use **NEXT** to go to the Events menu option, and press **ENTER**, or simply press [7].
3. Press [1] or **ENTER** to open the view event memory.

30.2 Clear Event Memory

Use the Clear Event Memory function to clear out event memory without turning your security system off and on again.

Clearing event memory:

1. Open the **Main Menu**.
2. Use **NEXT** to go to the Events menu option, and press **ENTER**, or simply press [7].
3. Use **NEXT** to go to the Clear Event Memory menu option, and press **ENTER**, or simply press [2].

30.3 View Log

Use the View Log function to review events stored in your security system. Reviewing past events might help you identify problems. Events are stored in the control panel's memory in order of occurrence, and tagged with the date and time.

Viewing the log:

1. Open the **Main Menu**.
2. Use **NEXT** to go to the Events menu option, and press **ENTER**, or simply press [7].
3. Use **NEXT** to go to the View Log menu option, and press **ENTER**, or simply press [3]. The keypad shows **Enter Start Date:**.

To view part of the log, enter the date (MM/DD) at which you wish to start the review. Press **ENTER**.

To view the entire log from the newest event, press **ENTER** without entering a start date. The date and time of the newest event shows. Use **PREV** or **NEXT** to move through the events. If an event description is longer than the display, the event description scrolls horizontally.

4. Press **ESC** to exit the menu.

31 D1260/D1255 keypads

Only the B9512G/B8512G control panels support the D1260 and D1255 Series keypads.

31.1 D1260 Series keypad overview

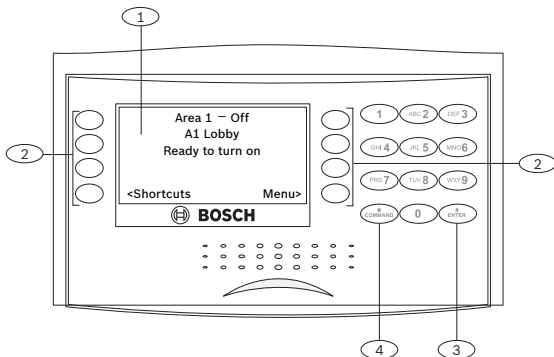

Callout Number	Description
1	Alphanumeric display
2	Softkeys

Callout Number	Description
3	ENTER
4	CMD key (Command)

31.2 D1255 Series keypad overview

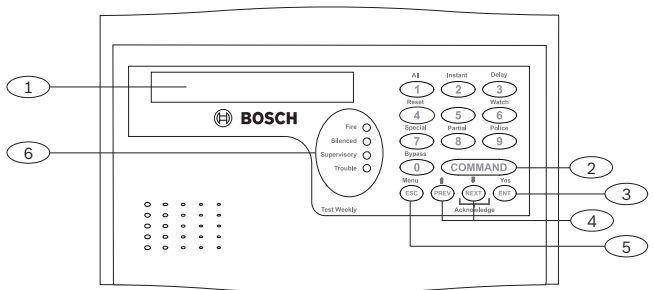
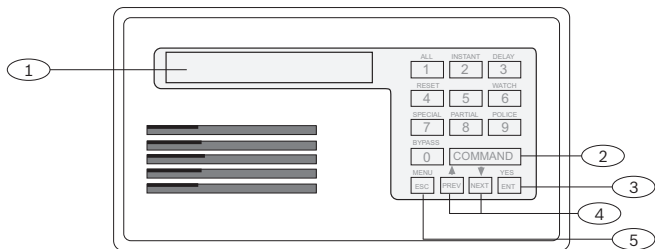

Callout Number	Description
1	Alphanumeric display)
2	CMD key (Command))
3	ENTER key
4	PREV and NEXT keys
5	ESC key (Escape)
6	System Status indicators (Fire keypads only)

31.3 Operation overview

Your security system provides quick access to functions through the keypad menus.

You initiate functions and open menus with the **CMD** key plus the one or two digit command. D1260 Series keypads, refer to the menu tree in *B94x/B93x menu tree and commands, page 45*. For D1255 Series keypads, refer to the menu tree in *B92x/B91x menu tree, page 126*.

To enter a command, press the **CMD** key and then the one or two digit command.

For instructions for using command-initiated menus, refer to the section of this book as listed in the following table. The listed sections explain the steps leading up to and including opening the menu you open by using the command. Follow the instructions as they apply to the commands.

Command	Function/ menu	D1260 Series refer to	D1255 Series refer to
CMD 0	Bypass	<i>Bypass, page 63</i>	<i>Bypass menu, page 143</i>
CMD 0 0	Unbypass		
CMD 1	All on (with delay)	<i>All On menu, page 51</i>	<i>All On menu, page 132</i>
CMD 1 1	All On, Instant		
CMD 2	Part On, Instant	<i>Part On menu, page 55</i>	<i>Part On menu, page 136</i>
CMD 3	Part On (with delay)		
CMD 4 7	Reset Sensors	<i>Reset, page 68</i>	<i>Reset, page 148</i>
CMD 5 0	Go to Area	<i>Go to area, page 78</i>	<i>Go to Area, page 157</i>
CMD 5 1	Extend Close	<i>Extend Closing, page 61</i>	<i>Extend Closing, page 141</i>
CMD 5 3	Delete User	<i>Delete User, page 98</i>	<i>Delete User, page 178</i>
CMD 5 5	Change Passcode	<i>Change Passcode, page 85</i>	<i>Change Passcode, page 166</i>
CMD 5 6	Add User	<i>Add User, page 87</i>	<i>Add User, page 168</i>

Command	Function/ menu	D1260 Series refer to	D1255 Series refer to
CMD 5 9	Show Revision	<i>Revisions, page 74</i>	<i>Revisions, page 154</i>
CMD 6	Watch Mode	<i>Watch Mode, page 99</i>	<i>Watch Mode, page 179</i>

**Notice!**

On these models of keypad, **CMD 5 6** only adds the user and passcode; it does not support configuring user name, authority level, keyfob, and tokens, and cards.

32 Options

This section describes optional features that your security company might have programmed for you.

32.1 Two-man Rule

The Two-man Rule adds an extra step to the process of turning off your security system by requiring two unique passcodes entered on the same keypad to turn off an area. Two-man Rule is disabled for SIA compliant systems.

Two-man Rule is:

enabled on my system.

disabled on my system.

Turning off with Two-man Rule enabled:

1. Enter the first passcode and press **ENTER**. The keypad shows a request for the second passcode.
2. Enter a second passcode and press **ENTER**. The second passcode must be different from the first passcode. The area turns off.

32.2 Early Ambush

When the Early ambush feature is enabled, the security system, requires two passcodes to turn off the area. Entering the first passcode turns the area off and begins counting down Early Ambush Time (_ minutes). A user must enter the second passcode before Early Ambush time expires. Early Ambush is disabled for SIA compliant systems.

If Early Ambush time expires before a user enters the second passcode, the system reports to your security company that the system was disarmed under duress.

You can enter the first passcode a second time as the second passcode.

You can enter the passcodes at the same keypad, or at different keypads (if keypads are assigned to the same area).

Early Ambush is:

enabled on my system.

disabled on my system.

Turning off with Early Ambush enabled:

1. Enter the first passcode and press **ENTER**. The keypad shows the system is turned off. Early ambush time begins counting down. The keypad does not indicate that early ambush time is counting down.
2. You must enter the second passcode before the Early Ambush time expires. **Warning!** Failure to cancel will result in alarm transmission and law enforcement may be dispatched.
3. Enter a second passcode and press **ENTER**. The keypad shows *Code 2 Validated* to confirm that the security system accepted the second passcode and stopped the Early Ambush time countdown. The system does not create a duress event.

32.3 Security system limitations

Not even the most advanced security system can guarantee protection against burglary, fire, or environmental threats. All security systems are subject to possible compromise or failure-to-warn for a variety of reasons including, but not limited to, the following:

- Sirens or horns placed outside the hearing range of people in remote areas of the building or in areas that are frequently closed off do not provide the intended protection.
- If intruders gain access through unprotected points of entry, the security system does not detect the intruders.
- If intruders have the technical means of bypassing, jamming, or disconnecting all or part of the security system, the security system cannot detect the intruders.
- If the AC power supply is OFF and the back-up battery is either missing or dead, the security system does not detect intrusion.
- Smoke detectors cannot detect smoke in chimneys, walls, or roofs, or smoke blocked by a closed door. They might not detect smoke or fire on a level of the building different from the one on which they are located. Smoke detectors might not be able to warn in time about fires started by explosions, improper storage of flammables, overloaded electrical circuits, or other types of hazardous conditions.
- If your security system's method of communication is down (phone line, cellular, or internet problems), reports from the security system to the security company cannot send. Communication methods are vulnerable to compromise by several means.

Inadequate maintenance and failure to test are the most common causes of alarm failure. Testing the system once a week is strongly recommended to ensure all system components are working properly.

Although having a security system might make you eligible for reduced insurance premiums, the security system is no substitute for insurance. Warning devices cannot compensate you for loss of life or property.

32.4 Cross points

Points can be assigned to cross point groups. When a point in a cross point group detects an alarm, the control panel starts the cross point timer. If a second point in the same cross point group detects an alarm while the cross point timer is active, the control panel sends alarm reports for both points.

If a single cross point detects an alarm and stays in alarm throughout the cross point timer, the control panel sends an alarm report only for that point. If a single point in a cross point group detects an alarm and restores while the timer is still active, the system sends an unverified event for that point. A second alarm on the first point does not create an alarm event, but rather an unverified event.

Cross points are:

enabled on my system.

disabled on my system.

32.5 Fire safety and evacuation

Residential fire is a leading cause of accidental death. Most fire related deaths occur at night when occupants suffocate in their sleep from smoke and toxic gases, rather than from burns. To help reduce this risk, implement the following program:

- Make a home escape plan. Draw a map of your home showing all doors and windows. Discuss the plan with everyone in your home.
- Know at least two ways out of every room, if possible. Make sure all doors and windows leading outside open easily.
- Have an outside meeting place (like a tree, light pole or mailbox), a safe distance from the home where everyone should meet.
- Practice your home fire drill at night and during the day with everyone in your home, twice each year.
- Practice using different ways out.
- Teach children how to escape on their own in case you can't help them.
- Close doors behind you as you leave.

If the alarm sounds:

- If the smoke alarm sounds, **get out and stay out**. Never go back inside for people or pets.
- If you have to escape through smoke, **get low and go** under the smoke to your way out.
- Call the fire department from outside your home.

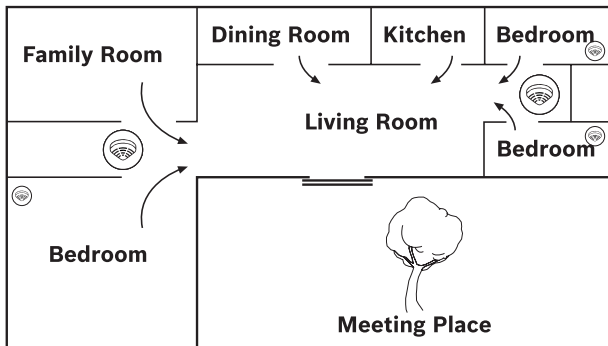

32.6 Multiple area systems

32.6.1 Keypad scope

Your security company can configure your security system so that keypads allow you view the status of and control only one area, a group of areas, or all of the areas in your system. The areas you can view and the area functions (actions) you can use at a keypad constitute the keypad's scope.

32.6.2 Authority levels

Each of your security system users is assigned an authority level. An authority level determines how much control the user has for any function that requires a passcode (turning an area on, for example). The authority level is set for each area in a multiple area system so that a user can have different levels in each area, if desired.

32.6.3 Scope and authority levels combined

The functions you can use at a keypad (turning All On, for example) are limited to the areas you have authority in, and the areas that are within a keypad's scope.

Example

Your security system protects a business configured for three areas (the office, the warehouse, and shipping), and three users (1, 2, and 3).

Keypads details:

- The keypad in the office area has scope for all areas. (Users can view the status of all areas – office, warehouse, and shipping.)
- The keypad in the warehouse has scope for the warehouse only.
- The keypad in shipping has scope for the warehouse and shipping.

Users details:

- User 1 has authority to turn the office area on and off, but no authority in the warehouse or shipping areas.
- User 2 has authority in the warehouse and shipping.
- User 3 has authority in all three areas.

When a user enters his or her passcode into a keypad, the security system allows the user to perform functions limited to both the user's authority level and the keypad's scope. What does this mean for the three users in the example? Specifically, which areas turn on when the user turns the system All On from each keypad?

User 1 at the office keypad		
Action	Area affected	Reason
View status?	All three	Keypad's scope includes all three areas
Perform passcode-protected functions?	Office	User's authority is limited to the office area

Result of turning the system All On? Only the office area turns on.

User 1 at the warehouse keypad		
Action	Area affected	Reason
View status?	Warehouse	Keypad's scope includes only the warehouse area
Perform passcode-protected functions?	None	User's authority is limited to the office area, which is not within the warehouse keypad's scope

Result of turning the system All On? No area turns on.

User 1 at the shipping keypad		
Action	Area affected	Reason

View status?	Warehouse and shipping	Keypad's scope includes both the warehouse and shipping areas
Perform passcode-protected functions?	None	User's authority is limited to the office area, which is not within the warehouse or shipping keypad's scope

Result of turning the system All On? No area turns on.

User 2 at the office keypad		
Action	Area affected	Reason
View status?	All three	Keypad's scope includes all three areas
Perform passcode-protected functions?	Warehouse and shipping	User's authority is limited to the warehouse and shipping areas

Result of turning the system All On? Only the warehouse and shipping areas turn on.

User 2 at the warehouse keypad		
Action	Area affected	Reason
View status?	Warehouse	Keypad's scope includes only the warehouse area
Perform passcode-protected functions?	Warehouse	User's authority includes the warehouse which is in the keypad's scope

Result of turning the system All On? Only the warehouse area turns on.

User 2 at the shipping keypad		
Action	Area affected	Reason

View status?	Warehouse and shipping	Keypad's scope includes both the warehouse and shipping areas
Perform passcode-protected functions?	Warehouse and shipping	User's authority level and the keypad's scope include both the warehouse and shipping

Result of turning the system All On? Only the warehouse and shipping areas turn on.

User 3 at the office keypad		
Action	Area affected	Reason
View status?	All three	Keypad's scope includes all three areas
Perform passcode-protected functions?	All three	User's authority includes all three areas

Result of turning the system All On? All three areas turn on.

User 3 at the warehouse keypad		
Action	Area affected	Reason
View status?	Warehouse	Keypad's scope includes only the warehouse area
Perform passcode-protected functions?	Warehouse	User's authority includes the warehouse which is in the keypad's scope

Result of turning the system All On? Only the warehouse area turns on.

User 3 at the shipping keypad		
Action	Area affected	Reason
View status?	Warehouse and shipping	Keypad's scope includes both the warehouse and shipping areas

Perform passcode-protected functions?	Warehouse and shipping	User's authority level and the keypad's scope include both the warehouse and shipping
---------------------------------------	------------------------	---

Result of turning the system All On? Only the warehouse and shipping areas turn on.

Glossary

All On

To turn on (arm) both interior points and perimeter points.

bypass

Selectively remove points from the security system. A point may be bypassed in order to arm the perimeter with a window open.

closing window

A duration of time programmed by your security company. Your security company can program the system to turn on at the end of the window.

entry delay

A programmed delay of system alarm response allowing an individual to enter an armed area through the correct point

and disarm the area. If not disarmed before the delay time expires, the system begins an alarm response which may include reports to the central station.

exit delay

A programmed delay of system alarm response allowing exit after arming an area. Failure to exit before the delay time expires, causes entry delay to begin. The system must then be disarmed. If not disarmed before the delay time expires, the system begins an alarm response which may include reports to the central station.

faulted point

A point that is not normal (a door or window is open).

keypress tone

The beep you hear each time you press a key.

output

The system may have outputs programmed to provide control of devices such as premises lighting or entry gates. The security company programs outputs for automatic control and/or control from the keypad.

Part On

An arming command that arms only the perimeter points.

point

A detection device connected to the security system. Points show on the keypad individually and with custom text. The text might describe a single door, motion sensor, smoke detector,

or an protected space such as UPSTAIRS or GARAGE.

trouble

A service condition that needs to be corrected, such as a broken wire.



Bosch Security Systems B.V.

Torenallee 49

5617 BA Eindhoven

Netherlands

www.boschsecurity.com

© Bosch Security Systems B.V., 2019