



CDVI



**SM300 &
SM500.**



ESM500

SM300 (300kg)

SM500 & ESM500 (500kg)



Surface Mount Electromagnetic locks

The installer's choice
cdvigroup.com

SM300 - SM500 - ESM500

Surface mount Electromagnetic locks

FEATURES

- **Holding force:**
SM300: 660 lbs (300kg) and **ESM500 & SM500 :** 1200 lbs (500kg)
- **Surface mounting**
- **Interior: SM300 & SM500.**
- **Waterproof: ESM500.**
- **High corrosion resistance: ESM500.**
- **Ease of installation.**
- **No residual magnetism.**
- **Built-in electronic protection to eliminate back EMF**

- Electromagnetic lock dimensions (L x W x D):
 - SM300 series = 10 x 1.7 x 1 in. (250 x 42.5 x 26mm).
 - SM500 series = 10.45 x 2.7 x 1.65 in. (265 x 67 x 41mm).
 - ESM500 = 9 x 2.5 x 1.65 in. (230 x 63 x 40mm).

- Armature dimensions (L x W x D):
 - SM300 = 7.1 x 1.5 x .5 in. (180 x 38 x 12mm).
 - SM500 = 7.3 x 2.5 x .65 in. (185 x 61.5 x 16mm).
 - ESM500 = 7.3 x 2.5 x .5 in. (185 x 61 x 12mm).

- Input voltage: 12/24V dc

- Power consumption:
 - 500mA @ 12 V DC
 - 250mA @ 24 V DC



SM300 & SM500.



ESM500



WEEE



RoHS



IP42



EC certification

ELECTRICAL CONNECTIONS

VOLTAGE INPUT JUMPER SETTING

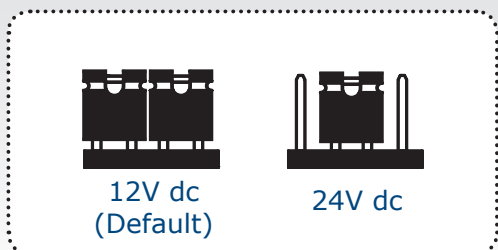

Terminal block	Correspondence
+	12 (Default) or 24V dc
-	- 0 V
N.C	NC (Normally closed)
COM	COM
N.O	NO (Normally open)

The NO/NC signal only switches when the door is closed and with the maglock power on.







IMPORTANT NOTE







Check the jumper position before connecting the lock to the input current. A wrong position could damage the lock. This type of damage is not covered by the warranty. Make sure that the magnet and the armature meet evenly over their entire mating surfaces.

PRODUCT CUT SHEET

SM300 - SM500 - ESM500
Surface mount Electromagnetic locks

SM300 PACKAGE CONTAIN





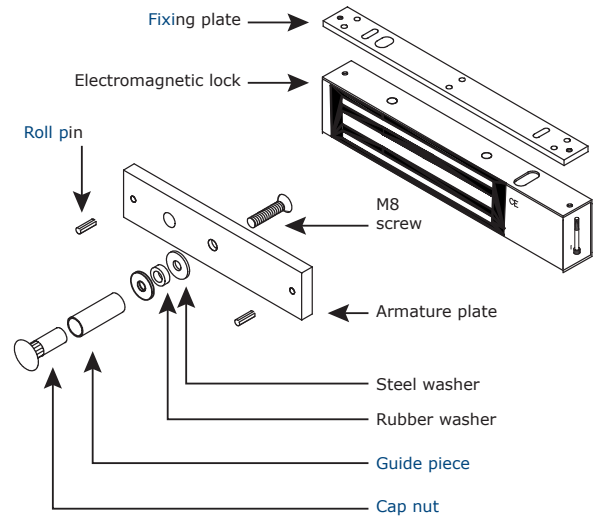

						
Surface mount magnet	Armature plate	Mounting plate	Roll pin 5x16	Steel washer	Rubber washer	M8x25 screw
1	1	1	2	2	1	1







					
Cap nut	Guide piece	Installation Manual	Key 3mm	Key 5mm	Wood screw 4x25
2	1	1	1	1	9

SM300 INSTALLATION



SM500 PACKAGE CONTAIN

					
Surface mount magnet	Armature plate	Mounting plate	Roll pin 5x16	Steel washer	Rubber washer
1	1	1	2	2	1

					
M8x25 screw	Wood screw 4x25	Key 5mm	Cap nut	Guide piece	Installation Manual
1	7	1	1	1	1

SM500 INSTALLATION

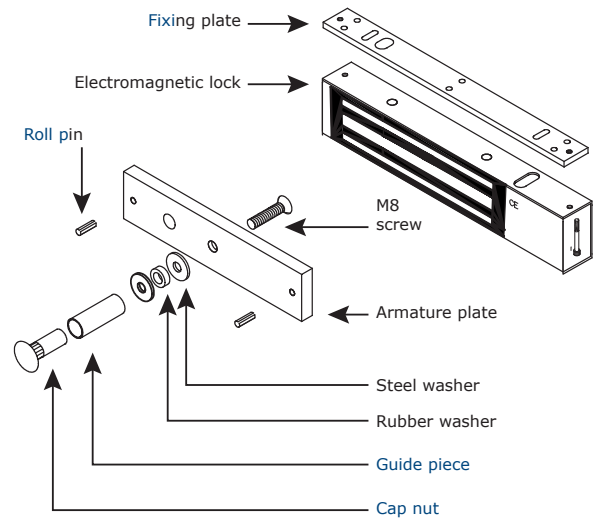



















The Armature plate must be able to pivot slightly about its center mounting screw to compensate for any door misalignment.

SM300 - SM500 - ESM500

Surface mount Electromagnetic locks

ESM500 PACKAGE CONTAIN

								
Surface mount magnetic lock	Armature plate	Stainless steel screw 3x10 (security ropes)	Cap nut	Guide piece	Steel screw nut 6x11	Seal up anchor	black steel screw 6x35	Stainless steel screw 6x40
1	1	2	1	1	1	4	1	2
								
Stainless steel screw 6x50	Stainless steel screw with rubber washer 8x35	Stainless steel Roll pin 5x16	Stainless steel washer 10x22	Stainless steel Strut 10x15	Hole cover plate	Rubber washer 9x15	5mm key	Installation Manual
2	1	2	2	2	4	1	1	1

ESM500 INSTALLATION

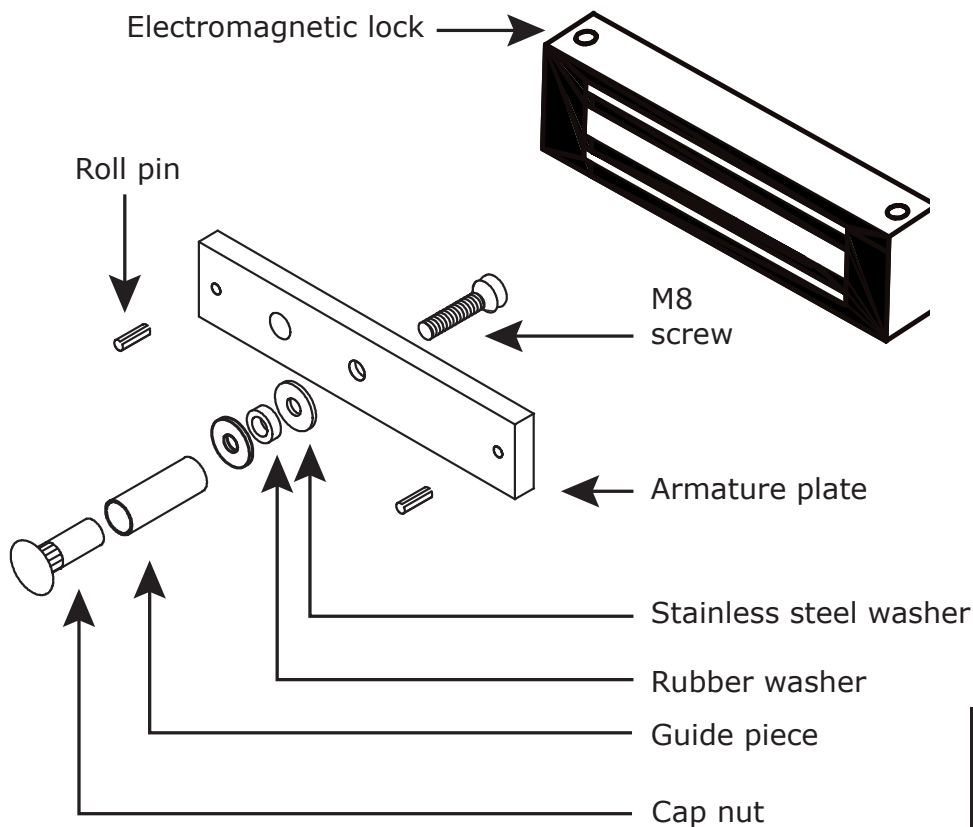

The Armature plate must be able to pivot slightly about its center mounting screw to compensate for any door misalignment.