

1

PLAN YOUR A22K NETWORK CONNECTIVITY

500 door system (100 doors connected IP + 400 doors connected RS485)

IP CONNECTIVITY

Out of the box the A22K is ready for IP connectivity, fifty (50) A22K per account.

If you have more than one A22K controller per account, one must be set as the **“Master”** controller to manage the others. These forty (49) others are defined as **“Sub-Controllers”**.

“MASTER” CONTROLLER

The **“Master”** controller manages up to forty nine (49) **“Sub-Controllers”**. (100 doors fully IP)

AES256
ENCRYPTION

TRIUM
ACCESS CONTROL

KRYPTO
HIGH SECURITY SOLUTION

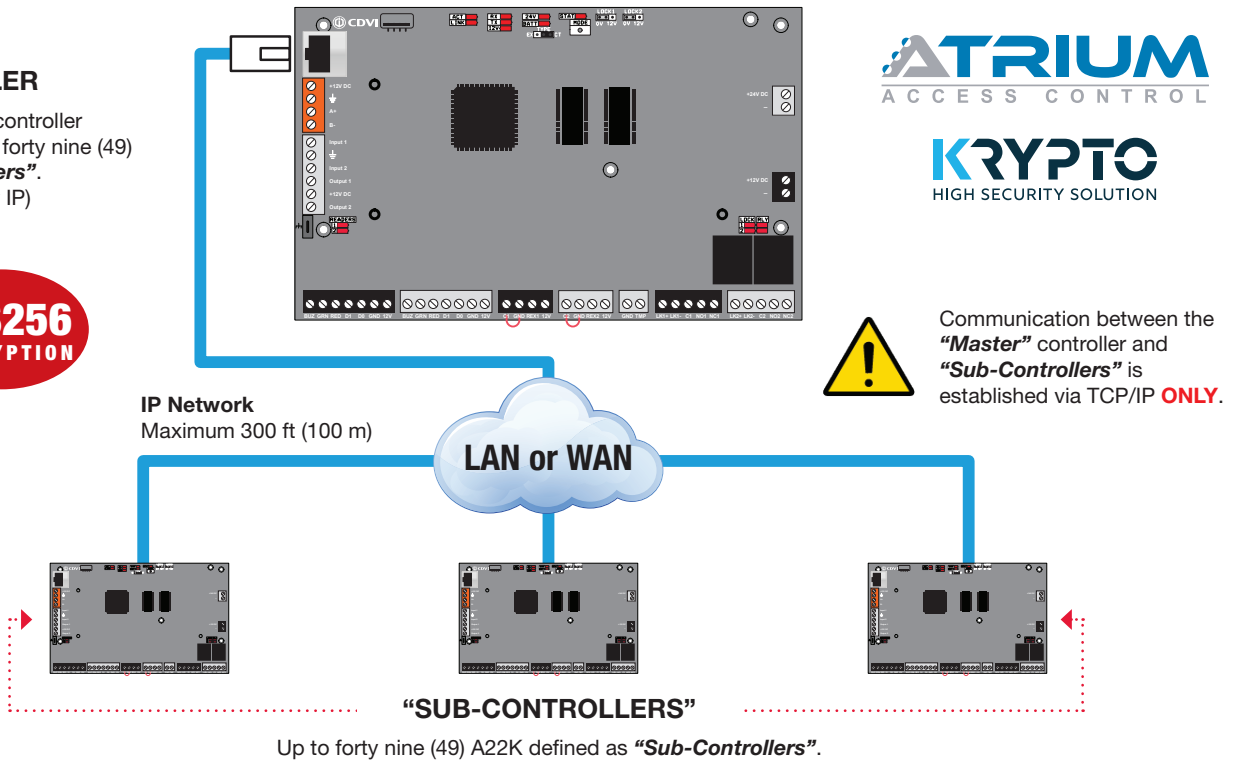

RS485 CONNECTIVITY

An A22K can be set as an **“Expander”**. Up to four (4) can be connected to the RS485 network (orange connector) of the **“Master”** and each **“Sub-Controller”**.

A22K **“Master”** or **“Sub-Controllers”**
RS485 port (orange connector).

Use twisted pair wiring for RS485 connection (1 pair for ground and 1 pair for A+ B-)

How to set an A22K as an “Expander”

On power OFF, move the **“Module Type”** jumper setting to the two pins closest to **“EX”**.



DO NOT use IP connection when an A22K is set as an **“Expander”**.

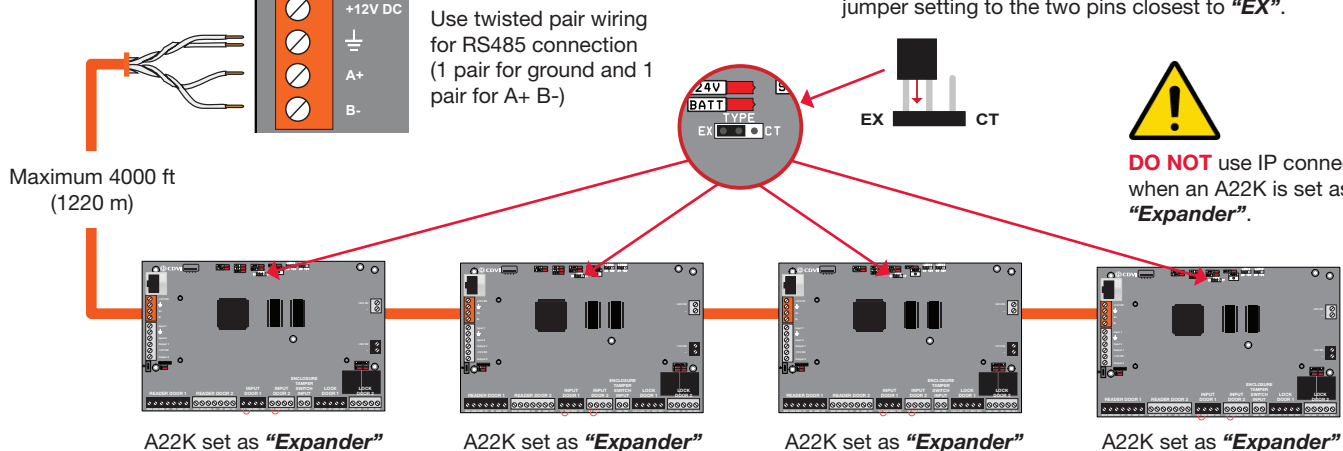

2 FIX METAL ENCLOSURE & A22K PCB

Install indoors in a safe and secure location. Suggested locations are electrical rooms, communication equipment rooms, closets or in the ceiling.

1. Fix the wall and door enclosure tamper switch
2. Install the metal enclosure on the wall
3. Mount the A22K pcb inside metal enclosure using pcb holders (red circles on the drawing)

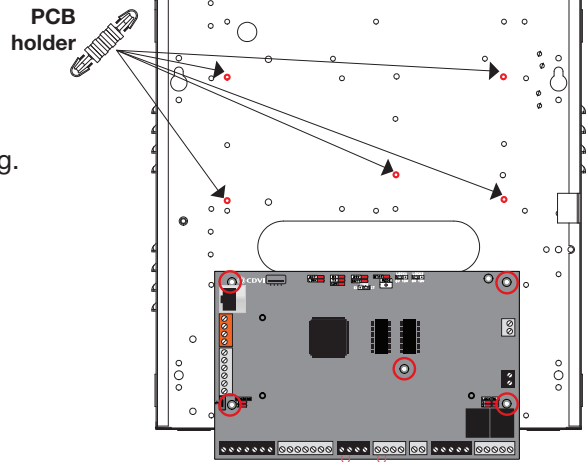

3 CONNECT METAL ENCLOSURE TAMPER SWITCHES

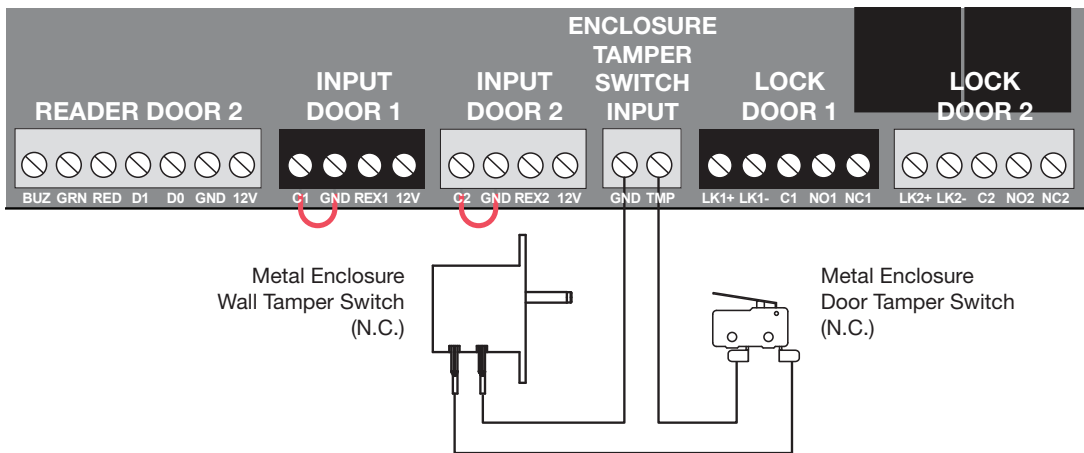

4 CONNECT K1 HIGH SECURITY CARD READER

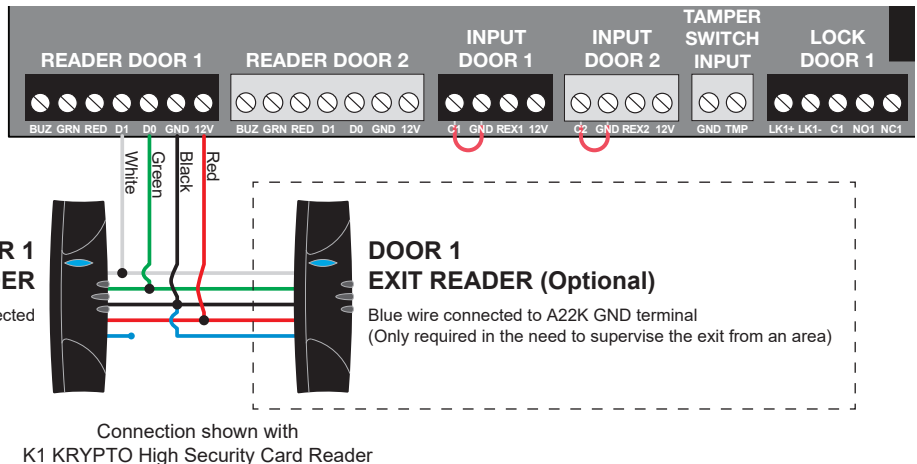

Step 4, 5 & 6 show the connection for door #1. Do the same for door # 2 using its terminals.

Connection shown with K1 KRYPTO High Security Card Reader

5 CONNECT THE LOCK

By default, the lock output is set for door strike (*“Fail Secure”*). The output is at 0 VDC to keep the door locked and toggles to 12 VDC during 5 sec., on access granted or request-to-exit, to unlock the door.

The A22K provides 12 VDC/750 mA for each door lock.

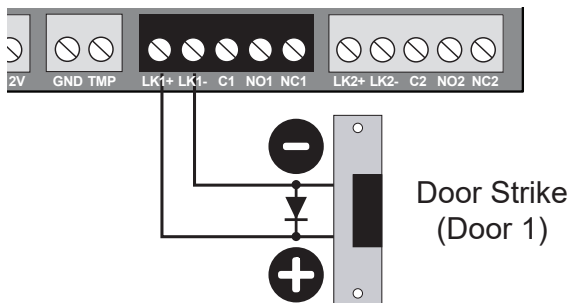

How to set the “Lock Output” for Electromagnetic Lock (Maglock)?

On power OFF, move the *“Lock Jumper Setting”* to the *“12V”* pins as shown here. The output will be now at 12 VDC to keep the door locked and toggles to 0 VDC during 5 sec., on access granted or request-to-exit, to unlock the door.

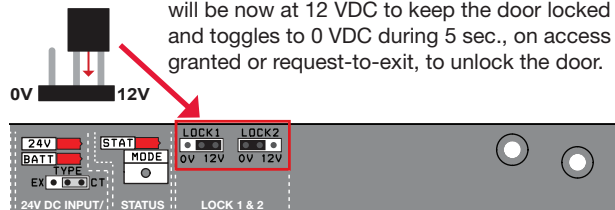

Refer to the full manual for the installation of lock working on 24 VDC using our on-board dry contact and an external power supply.

6 CONNECT THE DOOR CONTACT & REQUEST-TO-EXIT



Remove the jumper from the terminal before installing the door contact

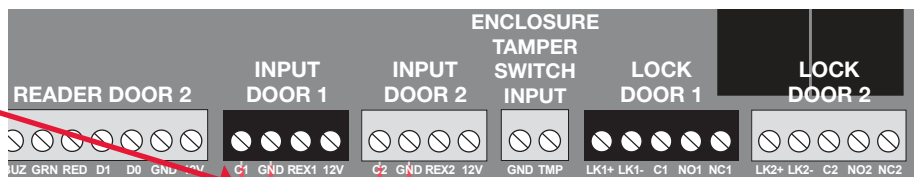

DOOR CONTACT

A door contact is required (default N.C.) to monitor door status (open or closed). It will generate an alarm (card reader beeping and flashing red) on a door forced event (access not allowed) or door open too long.

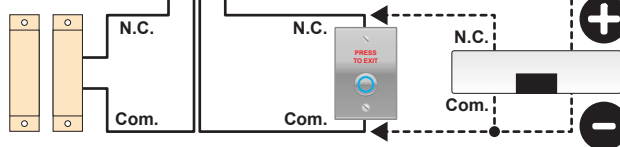

REQUEST-TO-EXIT (REX)

Since a door contact is operational, a REX is required (default N.C.) in order to exit a door without generating an alarm. The REX could be a push button or motion detector device.

7 CONNECT THE POWER SUPPLY TERMINAL & BACKUP BATTERY

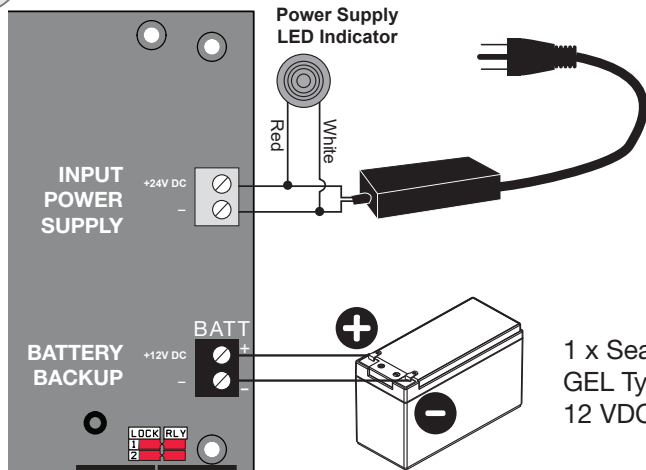

Plug the two pin terminal, to which LED and pre-installed universal power supply are connected, to the A22K pcb input power supply.



Always disconnect power terminal prior to service

1 x Sealed Rechargeable GEL Type Battery
12 VDC @ 7 Ah



Battery red & black cables are provided with the A22K

8 POWER UP THE A22K CONTROLLER

Simply plug the power cord into an AC electrical outlet.

LED on door metal enclosure illuminates green when power is established.

Universal Power Supply specifications:

Input: 120-240 VAC, 1.2 A, 50 Hz/60 Hz

Output: 24 VDC @ 2.5 A



Do not connect to a receptacle controlled by a switch.

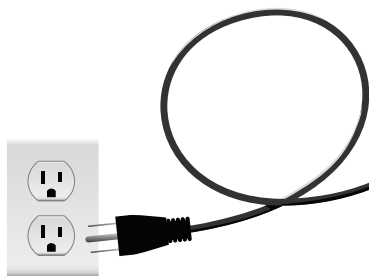

9 VIDEO TUTORIALS ON ATRIUM SYSTEM CONFIGURATION

The ATRIUM A22K controller includes an embedded web server. You can connect directly using your browser (PC, smartphone or tablet) and do basic configuration, such as add / delete a user, create and assign access levels to a user, etc. Simply install the **“ATRIUM Finder”** application (Apple Store or Google Play) and visit the CDVI website for all video tutorials on basic configuration via the embedded web server:

<https://www.cdvi.ca/cdvi-academy/videos/>

Use the FREE ATRIUM software for advanced configuration (PC only).



ATRIUM BASIC CONFIGURATION

Scan the QR Code with your smartphone for the ATRIUM system configuration quick start guide



A22K FULL MANUAL

Scan the QR Code with your smartphone for the full A22K manual



or visit CDVI website to download the manuals : www.cdvi.ca