

IS335 Passive Infrared Motion Sensor – Installation Instructions

1 Select the Mounting Location

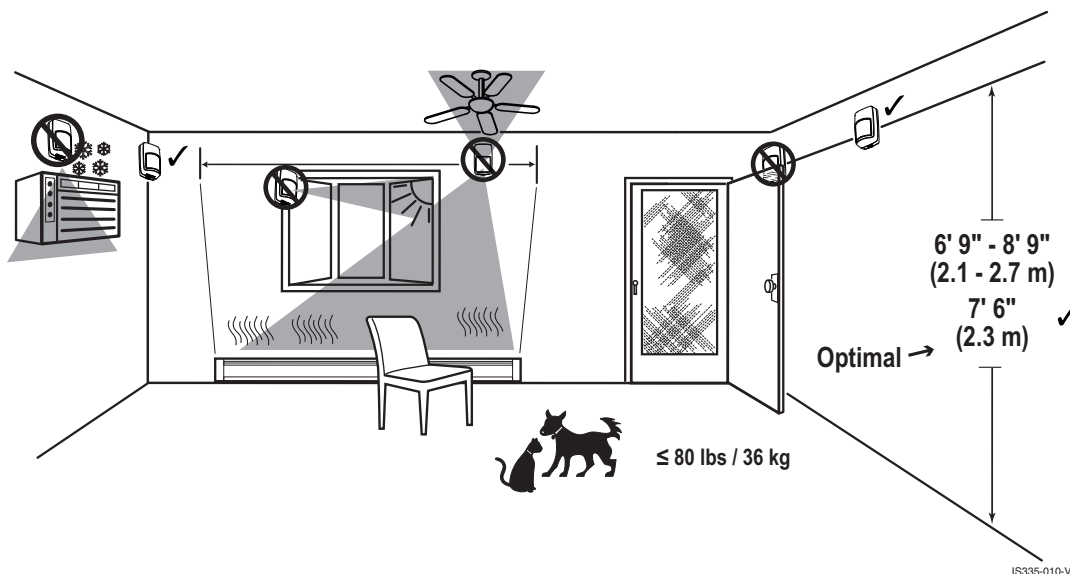

Mounting location guidelines:

- The optimal range is obtained at a mounting height of 7' 6" (2.3 m).
- Allow a clear line-of-sight to all areas to protect.
- Do not directly face windows.
- Avoid close proximity to moving machinery, fluorescent lights, and heating/cooling sources.
- For use in applications with pets up to 80 pounds (36 kilograms).

2 Retrieve Cover Locking Screw, Open Sensor and Remove Circuit Board

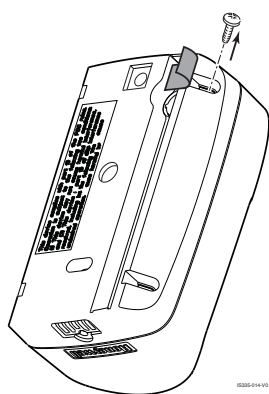

Remove tape from back housing and retrieve cover locking screw.

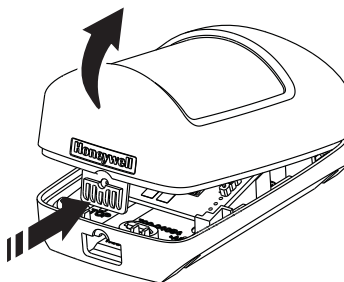

1. Press firmly on housing latch.
2. Pull up to separate the front and rear housing.

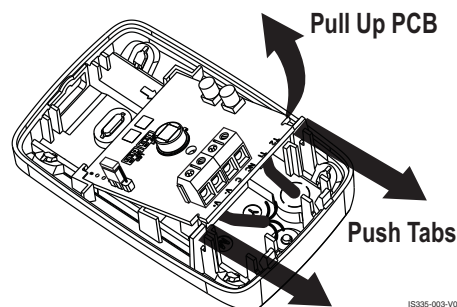

IS335-003-V0

3 Mount the Sensor

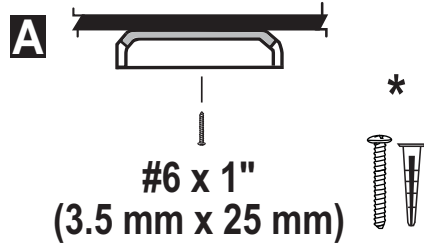
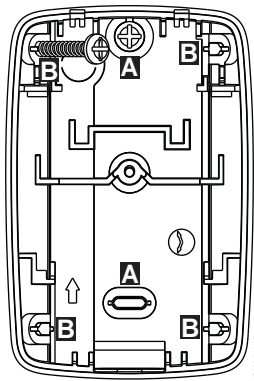

*Not included

- [A] = Wall mounting holes.
- [B] = Corner mounting holes.

IS3120IG-005-V0

4 Route Wires

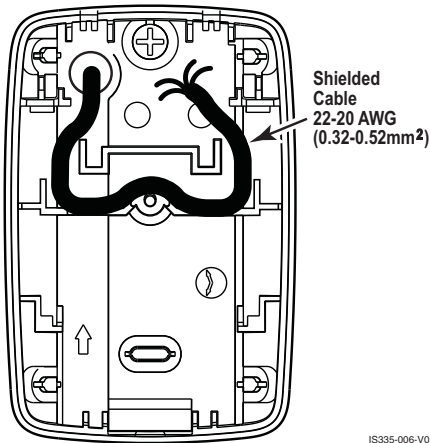

5 Reinstall Circuit Board

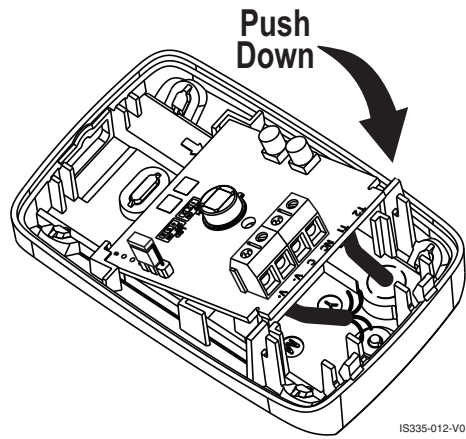

6 Connect Wires / Set Pet Immunity (PI) Jumpers

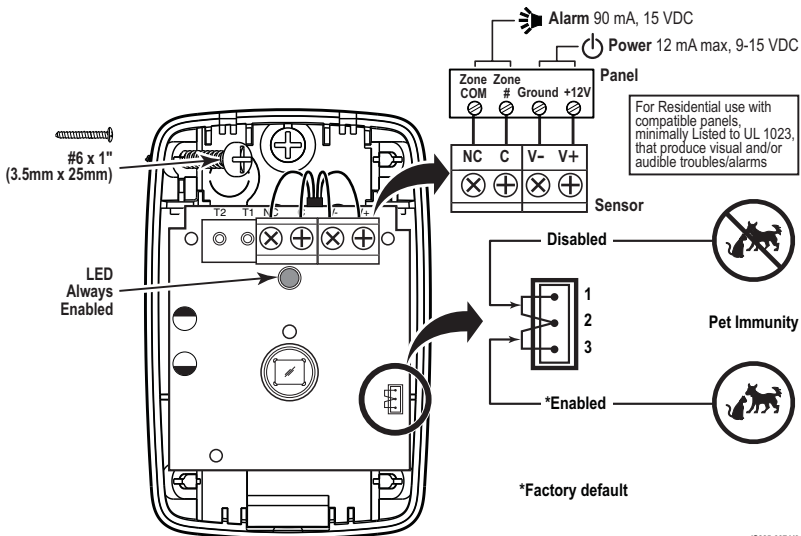

7 Assemble Front Cover

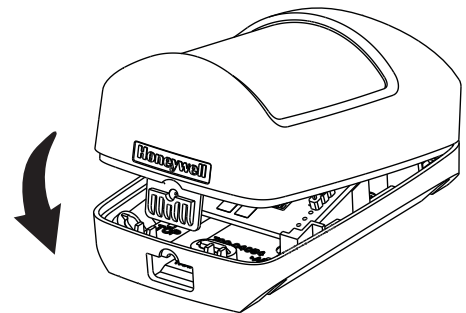

8 Perform Walk Test

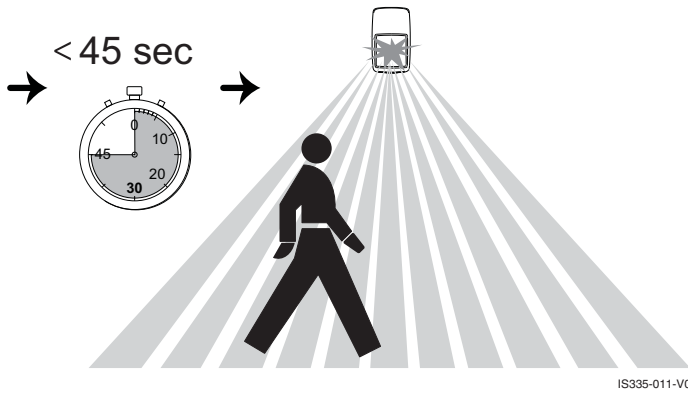

9 Install Cover Locking Screw

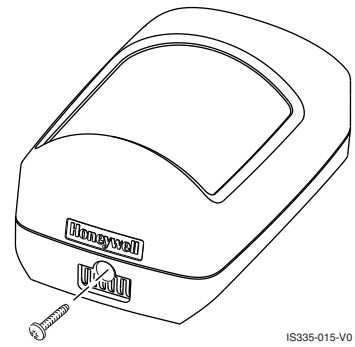

1. Close the sensor and apply power to the sensor. Initialization is complete when the LED stops flashing slowly (less than 45 seconds).
2. Walk through the detection area and observe the LED.

Detection Patterns

Top View

PLAN VIEW
ALL ZONES

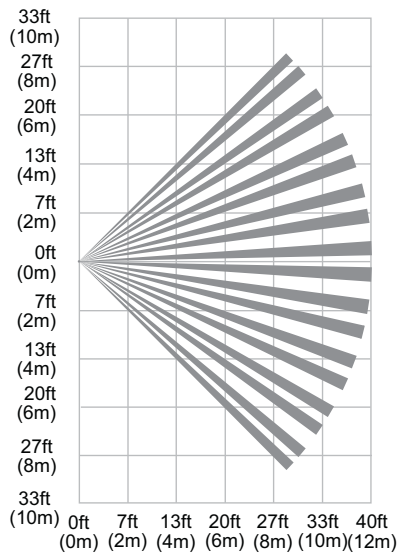

Side View

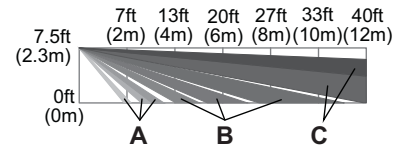

Zones

A	18	Lower
B	46	Intermediate
C	36	Long

RELAY OPERATION

	SENSOR STATUS		
	Normal	Intrusion	Trouble ¹
Alarm Relay	Closed	Open	Open

¹ For information on Trouble conditions, see the Troubleshooting section.

TROUBLESHOOTING

	NORMAL	TROUBLE*
		Self-Test Failure ¹
Alarm Relay	Closed	Open
Red LED	Off	Flashing

*TROUBLE CONDITIONS:

¹ Self-Test Failure conditions:

- PIR self-test failure: The sensor is disabled.
- Temperature compensation failure: The temperature compensation is disabled.

Depending on the Trouble condition, take the following corrective actions:

- Verify the power supply is sufficient (at least 9V at the sensor).
- Cycle power to the sensor.
- Walk test the sensor.

If the Trouble condition does not clear, replace the sensor.

SPECIFICATIONS

Range: 40' x 56' / 12 m x 17 m

Wall Mounting Height: 6'9" – 8'9" (2.1 m - 2.7 m); Optimal 7'6" (2.3 m)

Power: 9.0-15 VDC (UL: 9.5-15 VDC); 7 mA typical, 12 mA maximum; AC Ripple: 3 V peak-to-peak at nominal 12 VDC

Alarm Relay: Energized Form A; 90 mA, 15 VDC, 22 Ohms resistance maximum. Alarm Relay Duration: 3 seconds

RFI Immunity: 20V/m 10-1000MHz, 15V/m 1000-2700MHz

PIR White Light Immunity: 2000 Lux typical

Operating Temperature: 14° to 131° F / -10° to 55° C

Relative Humidity: 5 to 93% (UL tested at 93%); non-condensing

Temperature Compensation: Advanced Dual Slope

Dimensions: 3.39" H x 2.24" W x 1.71" D /

8.6 cm H x 5.7 cm W x 4.35 cm D

Weight: 2.15 oz / 61 g (net weight)

ACCESSORIES

SMB-10* (P/N 0-000-110-01)	Swivel Mount Bracket
SMB-10C* (P/N 0-000-111-01)	Swivel Mount Ceiling Bracket

* These accessories have not been evaluated by UL.

APPROVAL LISTINGS

- FCC part 15, Class B verified
- IC ICES-003, Class B verified
- ETL Listed to UL 639
- cETL Listed to ULC S306

Product must be tested at least once each year.

All wiring must be in accordance with: the National Electrical Code (ANSI/NFPA70); the Canadian Electrical Code, Part I (where applicable); UL681, Standard for Installation and Classification of Burglar and Holdup Alarm Systems; ULC-S302, Standard for Installation and Classification of Burglar Alarm Systems for Financial and Commercial Premises, Safes and Vaults; ULC-S310, Standard for Installation and Classification of Residential Burglar Alarm Systems; local codes and the authorities having jurisdiction.

The products are intended to be powered by a power-limited output of a UL/CUL Listed Burglar Alarm control unit, or via a Listed UL603/ULC-S318 power-limited power supply that provides 4 hours of standby power.

The sensor must be mounted indoors, within the protected premises, and on a wooden stud, solid wood or with a robust wall anchor.

UL Notes: All interconnecting devices must be UL Listed. The pet immunity feature has not been evaluated by UL.

FEDERAL COMMUNICATIONS COMMISSION AND INDUSTRY CANADA STATEMENTS
The user shall not make any changes or modifications to the equipment unless authorized by the Installation Instructions or User's Manual. Unauthorized changes or modifications could void the user's authority to operate the equipment.

CLASS B DIGITAL DEVICE STATEMENT

This equipment has been tested to FCC requirements and has been found acceptable for use. The FCC requires the following statement for your information:

This equipment generates and uses radio frequency energy and if not installed and used properly, that is, in strict accordance with the manufacturer's instructions, may cause interference to radio and television reception. It has been type tested and found to comply with the limits for a Class B computing device in accordance with the specifications in Part 15 of FCC Rules, which are designed to provide reasonable protection against such interference in a residential installation. However, there is no guarantee that interference will not occur in a particular installation. If this equipment does cause interference to radio or television reception, which can be determined by turning the equipment off and on, the user is encouraged to try to correct the interference by one or more of the following measures:

- If using an indoor antenna, have a quality outdoor antenna installed.
- Reorient the receiving antenna until interference is reduced or eliminated.
- Move the radio or television receiver away from the receiver/control.
- Move the antenna leads away from any wire runs to the receiver/control.
- Plug the receiver/control into a different outlet so that it and the radio or television receiver are on different branch circuits.
- Consult the dealer or an experienced radio/TV technician for help.

INDUSTRY CANADA CLASS B STATEMENT

This Class B digital apparatus complies with Canadian ICES-003.
Cet appareil numérique de la classe B est conforme à la norme NMB-003 du Canada.

FCC / IC STATEMENT

This device complies with Part 15 of the FCC Rules, and RSS-210 of Industry Canada. Operation is subject to the following two conditions: (1) This device may not cause harmful interference, and (2) This device must accept any interference received, including interference that may cause undesired operation.

Cet appareil est conforme à la partie 15 des règles de la FCC & de RSS-210 des Industries Canada. Son fonctionnement est soumis aux conditions suivantes: (1) Cet appareil ne doit pas causer d'interférences nuisibles. (2) Cet appareil doit accepter toute interférence reçue

For the latest documentation and online support information, please go to:

<http://www.security.honeywell.com/hsc/resources/MyWebTech/>

For the latest U.S. warranty information, please go to:

www.honeywell.com/security/hsc/resources/wa or contact your local authorized Honeywell representative for product warranty information.

© 2013 Honeywell International Inc. Honeywell is a registered trademark of Honeywell International Inc. All other trademarks are the properties of their respective owners.

Honeywell

2 Corporate Center Drive, Suite 100
P.O. Box 9040, Melville, NY 11747
www.honeywell.com/security



800-19276-01 09/14 Rev B