



**OFFICE OF STATEWIDE HEALTH PLANNING AND DEVELOPMENT
FACILITIES DEVELOPMENT DIVISION**

**APPLICATION FOR OSHPD PREAPPROVAL
OF MANUFACTURER'S CERTIFICATION (OPM)**

OFFICE USE ONLY	
APPLICATION #:	OPM-0286-13

OSHPD Preapproval of Manufacturer's Certification (OPM)

Type: New Renewal Update to Pre-CBC 2013 OPA Number: _____

Manufacturer Information

Manufacturer: Milestone AV Technologies

Manufacturer's Technical Representative: Michael Harrell

Mailing Address: 8401 Eagle Creek Parkway, Ste 700, Savage, MN. 55378

Telephone: (952) 225-6313 Email: Michael.harrell@milestone.com

Product Information

Product Name: MTMP1U Series Monitor Wall Mounts

Product Type: Computer OPM-0286-13

Product Model Number: MTMP1U BY: William Staehlin

General Description: Wall Mount for Video Monitor DATE: 02/18/2016

Applicant Information

Applicant Company Name: EASE Co.

Contact Person: Jonathan Roberson, S.E.

Mailing Address: 5877 Pine Ave. Suite 210, Chino Hills, CA. 91709

Telephone: (909) 606-7622 Email: J.Roberson@EASECo.com

I hereby agree to reimburse the Office of Statewide Health Planning and Development review fees in accordance with the California Administrative Code, 2013.

Signature of Applicant:  Date: 12/7/15

Title: Principal Engineer Company Name: EASE Co.

"Access to Safe, Quality Healthcare Environments that Meet California's Diverse and Dynamic Needs"





**OFFICE OF STATEWIDE HEALTH PLANNING AND DEVELOPMENT
FACILITIES DEVELOPMENT DIVISION**

Registered Design Professional Preparing Engineering Recommendations

Company Name: EASE Co.

Name: Jonathan Roberson, S.E. California License Number: S4197

Mailing Address: 5877 Pine Ave. Suite 210, Chino Hills, CA. 91709

Telephone: 909-606-7667 Email: J.Roberson@EASECo.com

OSHPD Special Seismic Certification Preapproval (OSP)

- Special Seismic Certification is preapproved under OSP- (Separate application for OSP is required)
- Special Seismic Certification is not preapproved

Certification Method(s)

- Testing in accordance with: ICC-ES AC156 FM 1950-10
- Other* (Please Specify): _____

*Use of test criteria other than those adopted by the California Building Standards Code, 2013 (CBSC 2013) for component supports and attachments are not permitted. For distribution system, interior partition wall, and suspended ceiling seismic bracings, test criteria other than those adopted in the CBSC 2013 may be used when approved by OSHPD prior to testing.

- Analysis
- Experience Data
- Combination of Testing, Analysis, and/or Experience Data (Please Specify): _____

List of Attachments Supporting the Manufacturer's Certification

- Test Report Drawings Calculations Manufacturer's Catalog
- Other(s) (Please Specify): _____

OFFICE USE ONLY – OSHPD APPROVAL VALID FOR CBC 2013 ONLY

Signature: *William Staehlin* Date: 02/18/2016

Print Name: William Staehlin

Title: SSE

Condition of Approval (if applicable): _____

"Access to Safe, Quality Healthcare Environments that Meet California's Diverse and Dynamic Needs"





**EQUIPMENT ANCHORAGE
& SEISMIC ENGINEERING**

5877 Pine Ave, Ste. 210
Chino Hills, CA. 91709
Phn: (909) 606-7622

Office of Statewide Health Planning and Development
PREAPPROVAL OF MANUFACTURER'S CERTIFICATION
OPM-0286-13

THIS PREAPPROVAL CONFORMS TO THE 2013 CALIFORNIA BUILDING CODE

MANUFACTURER: **MILESTONE INC.**
EQUIPMENT NAME: **MTMP1U SERIES MONITOR WALL MOUNT**

Sheet: 1 of 6
Date: 2/10/16

GENERAL NOTES

1. THIS OSHPD PREAPPROVAL OF MANUFACTURER'S CERTIFICATION (OPM) IS BASED ON THE 2013 CBC. THE DEMANDS (DESIGN FORCES) FOR USE WITH THIS OPM SHALL BE BASED ON THE 2013 CBC
2. THIS DOCUMENT MAY ONLY BE USED WITH THE EXPRESS WRITTEN CONSENT OF THE MANUFACTURER LISTED ABOVE FOR THE SPECIFIC PROJECT SITE AND INSTALLATION LOCATION. THIS DOCUMENT IS INVALID WITHOUT SUCH CONSENT.
3. THIS PREAPPROVAL CONFORMS TO THE 2013 CALIFORNIA BUILDING CODE WHERE S_{ds} IS NOT GREATER THAN 2.20.
4. FORCES PER ASCE 7-10 SECTION 13.3.1, EQUATIONS 13.3-1, 13.3-2 & 13.3-3,
WHERE $S_{ds} = 2.20$, $a_p = 2.5$, $I_p = 1.5$, $R_p = 2.5$, $z/h \leq 1$ CONCRETE WALL. SEE FOLLOWING SHEETS FOR Ω .
5. THIS PREAPPROVAL COVERS ONLY THE SUPPORTS AND ATTACHMENTS OF THE EQUIPMENT TO THE STRUCTURE.
6. ALL DESIGN FORCES SHOWN ON THE DRAWINGS ARE FACTORED LOADS THAT SHALL BE USED FOR STRENGTH DESIGN.
7. SHEET METAL SCREWS SHALL BE TEKS SCREWS BY ITW BUILDEX (ICC ESR-1976).
8. CONCRETE WALL DETAIL VALID FOR DEMANDS SHOWN AT ANY ELEVATION. (i.e. $z/h \leq 1$)
9. **RESPONSIBILITIES OF THE STRUCTURAL ENGINEER OF RECORD OF THE BUILDING**
 - A. PROVIDE SUPPORTING STRUCTURE TO SUPPORT WEIGHTS AND FORCES SHOWN IN ADDITION TO ALL OTHER LOADS.
 - B. VERIFY THAT THE INSTALLATION IS IN CONFORMANCE WITH THE 2013 CBC AND WITH THE DETAILS, MATERIAL AND GAGE OF THE UNIT WHERE ATTACHMENTS ARE MADE AGREE WITH THE INFORMATION SHOWN ON THE PREAPPROVAL DOCUMENTS.
 - C. VERIFY THAT PROJECT SPECIFIC VALUES OF S_{ds} & z/h RESULT IN SEISMIC FORCES (E_h , E_v) THAT DO NOT EXCEED THE VALUES ON THE DETAILS.
 - D. VERIFY THAT THE CONCRETE WALL TO WHICH THE EQUIPMENT IS ANCHORED MEETS THE REQUIREMENTS OF THE APPLICABLE ICC ESR.
 - E. VERIFY THAT THE ANCHORS ARE AN ADEQUATE DISTANCE FROM ANY CONCRETE WALL EDGES OR OPENINGS (SEE TYPICAL DETAIL ON SHEET 2).
 - F. VERIFY THAT ALL NEW OR EXISTING ANCHORS ARE AN ADEQUATE DISTANCE FROM THE UNIT ATTACHMENTS AND CHECK FOR INTERACTION WHERE OTHER ANCHORS ARE WITHIN 18" OR $6h_{ef}$ FROM THIS UNIT'S ANCHORS.
 - G. DESIGN BACKING BARS, STUDS, ETC. WHICH THE UNITS ARE ATTACHED TO AS NOTED ON THE DRAWINGS.



MILESTONE INC.

**MTMP1U SERIES MONITOR
WALL MOUNT**

DES. **J. ROBERSON**

JOB NO. **11-1518**

DATE **2/10/16**

SHEET

2

OF **6** SHEETS

9. EXPANSION ANCHORS:

A. ATTACHMENT IS TO BE MADE WITH THE ANCHORS LISTED BELOW AND INSTALLED AS DESCRIBED IN THE CORRESPONDING ICC REPORT.

Anchor Diameter	Concrete Type	Min. f _c (psi)	Anchor Type	ICC Report No.	Min. Embed.	Min. Spacing	Min. Edge Dist.	Min. Conc. Thickness	Torque Test	Direct Tension Test
1/4"	Normal Weight	3000	Hilti Kwik HUS	ESR-3027	1.92"	2.5"	12"	6"	N/A	779

B. THIS PREAPPROVAL ALLOWS FOR UP TO A MAXIMUM OF 2 ADJACENT CONCRETE WALL EDGES, 12" AWAY MINIMUM (i.e. - CORNER). SEE ADJACENT DETAIL FOR ADDITIONAL MINIMUM ALLOWABLE CONCRETE EDGE DISTANCES.

C. TESTING OF CONCRETE SCREW ANCHORS PER 2013 CBC, 1913A.7: TESTING SHALL BE DONE IN THE PRESENCE OF THE SPECIAL INSPECTOR AND A REPORT OF THE TEST RESULTS SHALL BE SUBMITTED TO OSHPD

(i) AFTER AT LEAST 24 HOURS HAVE ELAPSED SINCE INSTALLATION, DIRECT PULL TENSION TEST OR AT LEAST 50% OF THE ANCHORS.

(ii) ACCEPTANCE CRITERIA:

- DIRECT TENSION TEST: THE ANCHOR SHOULD HAVE NO OBSERVABLE MOVEMENT AT THE TEST LOAD. A PRACTICAL WAY TO DETERMINE OBSERVABLE MOVEMENT IS THAT THE WASHER BECOMES LOOSE.

(iii) IF ANY ANCHOR FAILS, TEST ALL ANCHORS.

D. AVOID DAMAGING EXISTING STEEL REINFORCING IN CONCRETE WALL WHEN INSTALLING CONCRETE SCREW ANCHORS.

E. PROVIDE FOR FULL THREAD ENGAGEMENT OF NUT & WASHER.

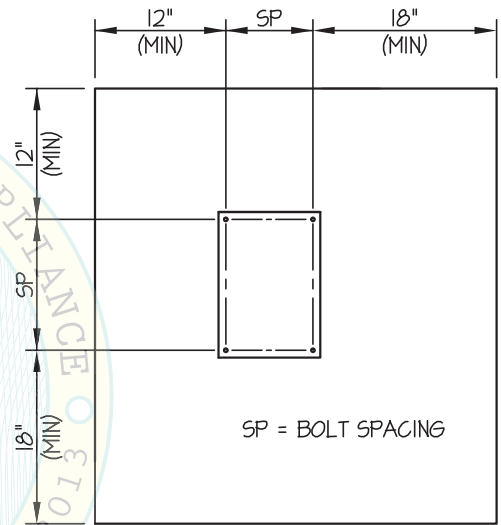

TYPICAL CONCRETE EDGE DETAIL

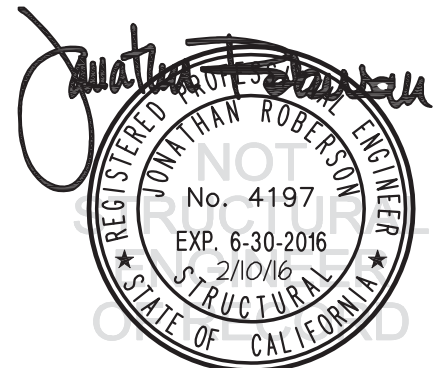
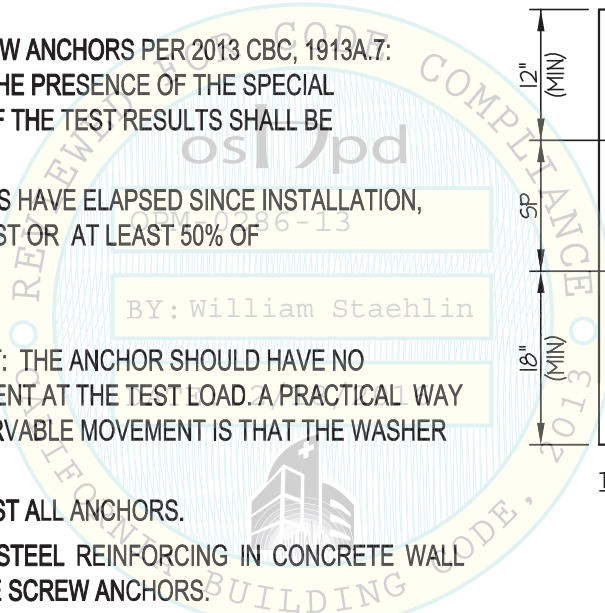

MILESTONE INC.

**MTMP1U SERIES MONITOR
WALL MOUNT**

DES. **J. ROBERSON**

JOB NO. **11-1524**

DATE **2/10/16**

SHEET

3

OF **6** SHEETS

SEISMIC SUPPORTS & ATTACHMENTS

WALL MOUNTED

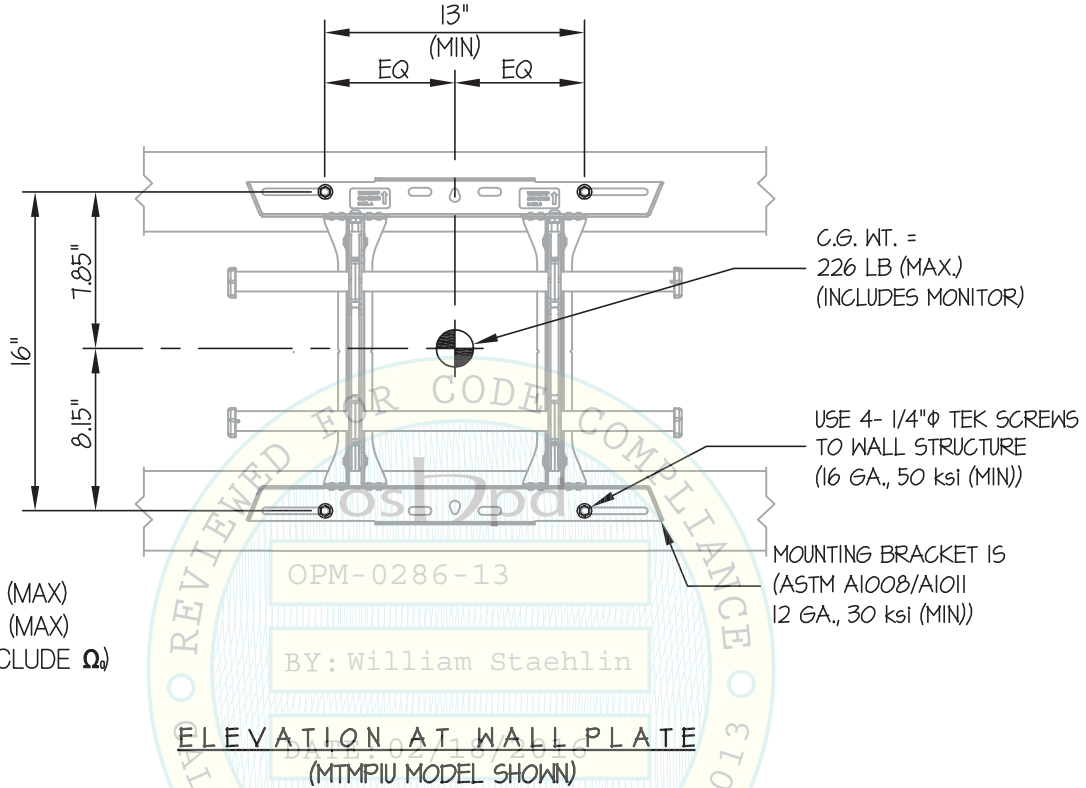

$T_u = 187 \text{ LB/SCREW (MAX)}$
 $V_u = 129 \text{ LB/SCREW (MAX)}$
(VALUES DO NOT INCLUDE Ω)

NOTES:

1. **FORCES ARE DETERMINED PER 2013 CALIFORNIA BUILDING CODE AND ASCE 7-10**
STRENGTH DESIGN IS USED. ($S_{ds} = 2.20$, $a_p = 1.0$, $I_p = 1.5$, $R_p = 2.5$, $z/h \leq 1$)

HORIZONTAL FORCE (E_h) = $1.58 W_p$

VERTICAL FORCE (E_v) = $0.44 W_p$

2. CENTER OF GRAVITY (C.G.) AND WEIGHT ARE THE GOVERNING PARAMETERS FOR DESIGN. THIS PREAPPROVAL ENCOMPASSES ALL WEIGHTS UP TO THE MAXIMUM WEIGHT SHOWN.
3. STRUCTURAL ENGINEER OF RECORD FOR THE BUILDING SHALL PROVIDE SUPPORT STRUCTURE DESIGNED TO SUPPORT WEIGHTS AND FORCES SHOWN IN COMBINATION WITH ALL OTHER LOADS THAT MAY BE PRESENT.
4. SEE GENERAL NOTES: SHEETS 1 AND 2.



MILESTONE INC.

**MTMP1U SERIES MONITOR
WALL MOUNT**

DES. **J. ROBERSON**

JOB NO. **11-1524**

DATE **2/10/16**

SHEET

4

OF **6** SHEETS

SEISMIC SUPPORTS & ATTACHMENTS

WALL MOUNTED

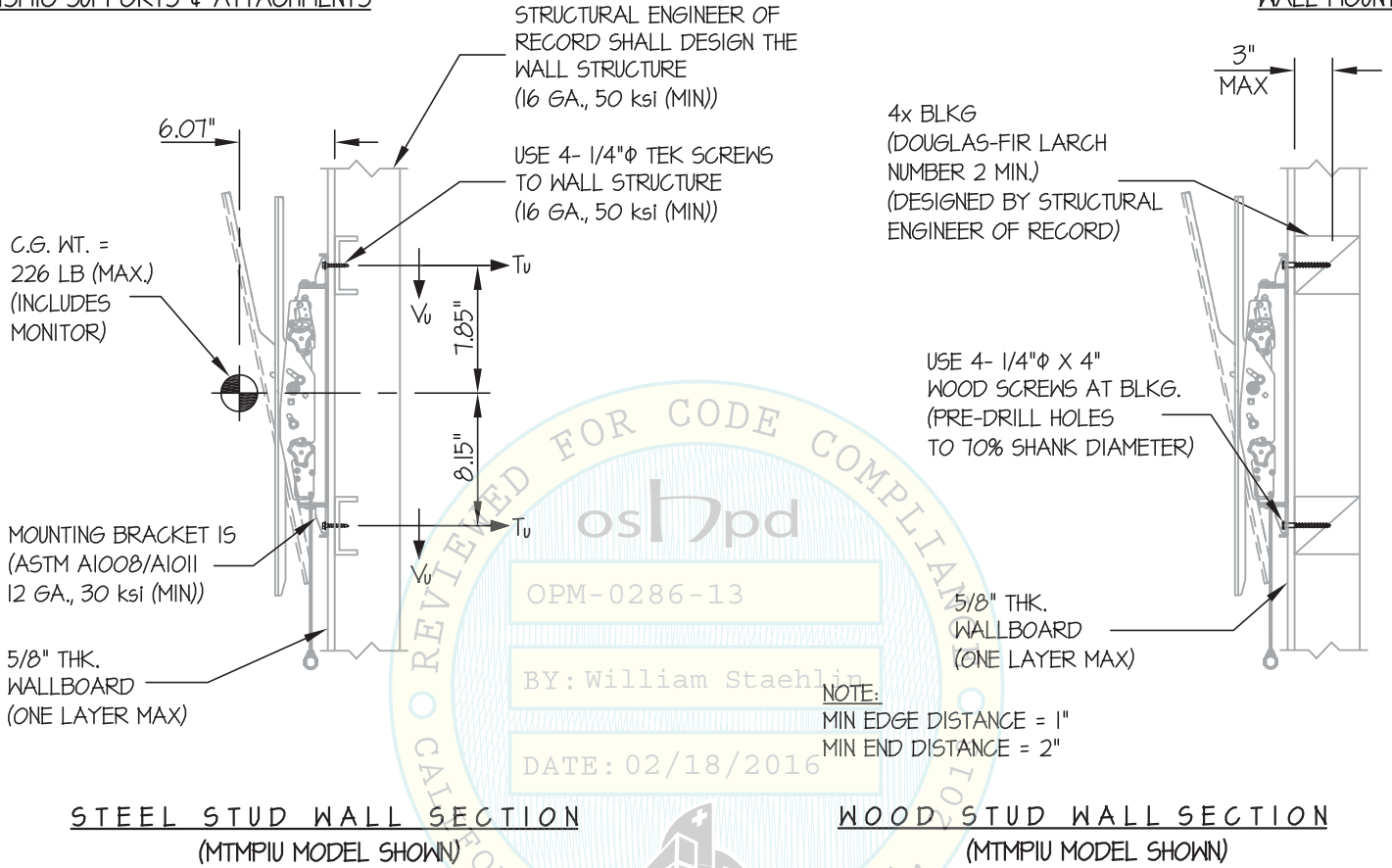

STEEL STUD WALL SECTION
(MTMP1U MODEL SHOWN)

WOOD STUD WALL SECTION
(MTMP1U MODEL SHOWN)

MILESTONE INC.

**MTMP1U SERIES MONITOR
WALL MOUNT**

DES. **J. ROBERSON**

JOB NO. **11-1524**

DATE **2/10/16**

SHEET

5

OF **6** SHEETS

SEISMIC SUPPORTS & ATTACHMENTS

WALL MOUNTED

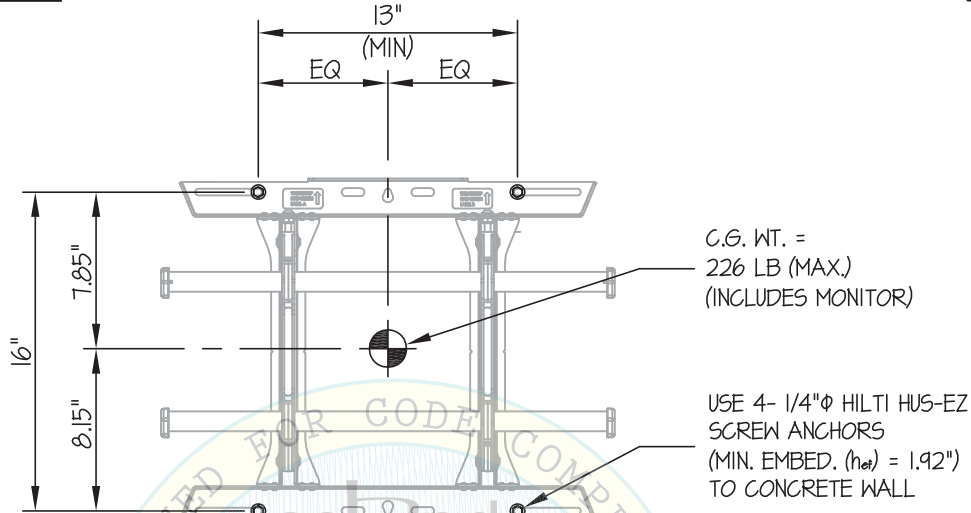

T_u = 349 LB/SCREW (MAX)
V_u = 247 LB/SCREW (MAX)
(VALUES INCLUDE Ω)

OPM-0286-13
BY: William Staehlin
ELEVATION AT WALL PLATE
D (MTMP1U MODEL SHOWN)

NOTES:

1. FORCES ARE DETERMINED PER 2013 CALIFORNIA BUILDING CODE AND ASCE 7-10 STRENGTH DESIGN IS USED. (S_{Ds} = 2.20, α_p = 1.0, I_p = 15, R_p = 2.5, Ω_e = 2.5, z/h ≤ 1)

HORIZONTAL FORCE (E_h) = 1.58 W_p

HORIZONTAL FORCE (E_{mh}) = 3.96 W_p (FOR CONCRETE ANCHORAGE)

VERTICAL FORCE (E_v) = 0.44 W_p

2. CENTER OF GRAVITY (C.G.) AND WEIGHT ARE THE GOVERNING PARAMETERS FOR DESIGN. THIS PREAPPROVAL ENCOMPASSES ALL WEIGHTS UP TO THE MAXIMUM WEIGHT SHOWN.

3. STRUCTURAL ENGINEER OF RECORD FOR THE BUILDING SHALL PROVIDE SUPPORT STRUCTURE DESIGNED TO SUPPORT WEIGHTS AND FORCES SHOWN IN COMBINATION WITH ALL OTHER LOADS THAT MAY BE PRESENT.

4. SEE GENERAL NOTES: SHEETS 1 AND 2.



MILESTONE INC.

**MTMP1U SERIES MONITOR
WALL MOUNT**

DES. **J. ROBERSON**

JOB NO. **11-1524**

DATE **2/10/16**

SHEET

6

OF **6** SHEETS

SEISMIC SUPPORTS & ATTACHMENTS

WALL MOUNTED

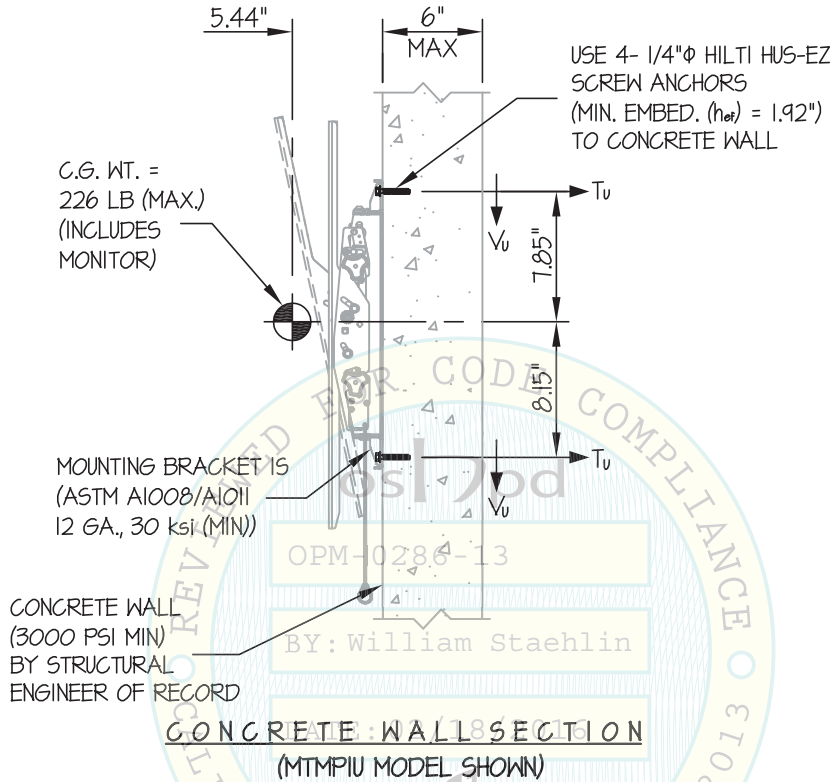

Jonathan Roberson

REGISTERED PROFESSIONAL ENGINEER
JONATHAN ROBERSON
No. 4197
EXP. 6-30-2016
2/10/16
STRUCTURAL
STATE OF CALIFORNIA