



COSTAR
VIDEO SYSTEMS

USER MANUAL

CCI2100HW

1 Introduction

The network camera supports the network service for a sensor image with progressive scan, which can be monitored on a real-time screen regardless of distances and locations. By using its dedicated program, many users are able to have an access to the network camera at once or a single user can monitor various network cameras at the same time. It also enables users to play, store and retrieve a monitoring image by using a PC. All the settings and real-time monitoring screens are also provided through an access to the web.

The network camera is fully featured for security surveillance and remote monitoring needs. It is based on the DSP compression chip, and makes it available on the network as real-time, full frame rate Motion JPEG and H.264 video streams.

1.1 Components

This system comes with the following components;

Network Camera	1
Installation Guide / CD	1
BNC Cable (Optional)	1
U-shaped Mount	1
Bracket Extenders	2
Hardware (two types of mounting screws)	

2 Installation

2.1 Basic Configuration of Camera System

The camera must be installed by qualified service personnel in accordance with all local and federal electrical and building codes.

C/CS Mount Camera

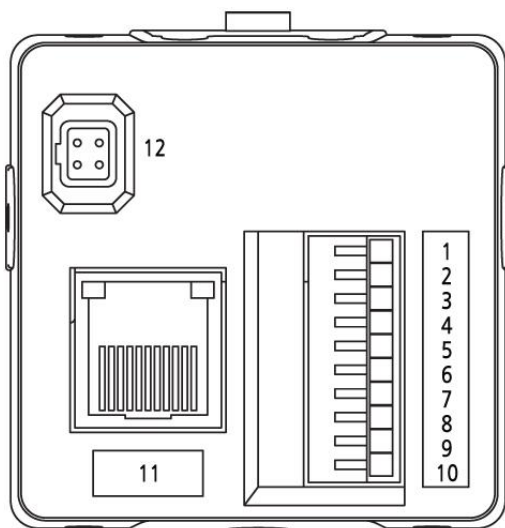

No.	Description
1	12VDC
2	GND
3	AUDIO IN
4	AUDIO OUT
5	GND
6	ALARM IN
7	ALARM OUT
8	GND
9	VIDEO OUT(CVBS)
10	GND
11	NETWORK / PoE
12	DC - IRIS

• Installing Camera

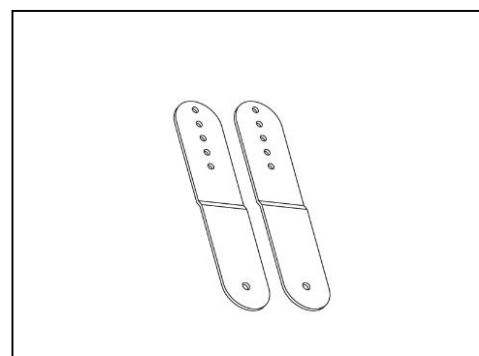
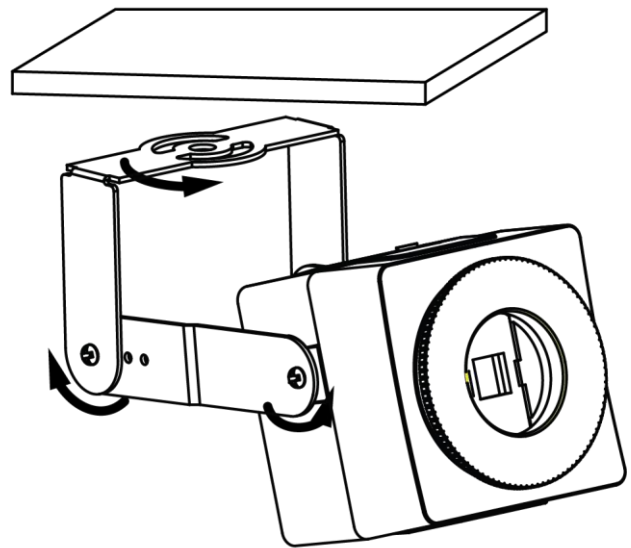
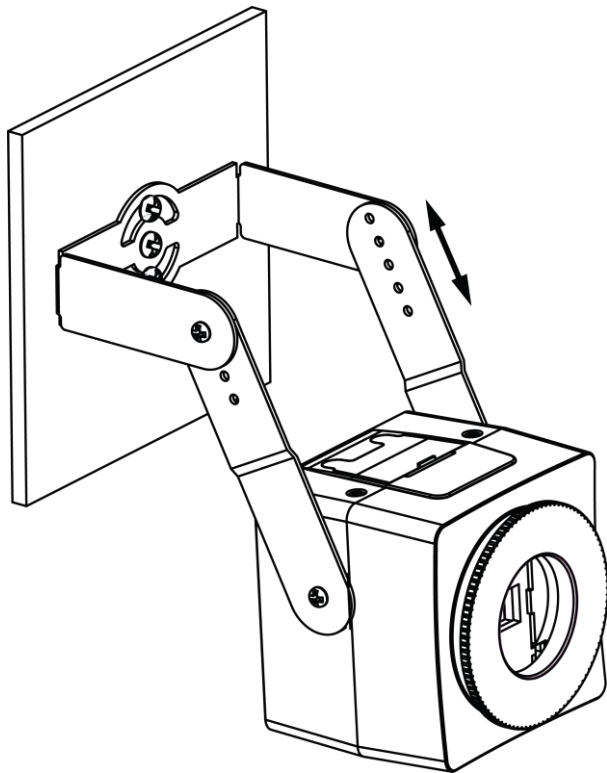
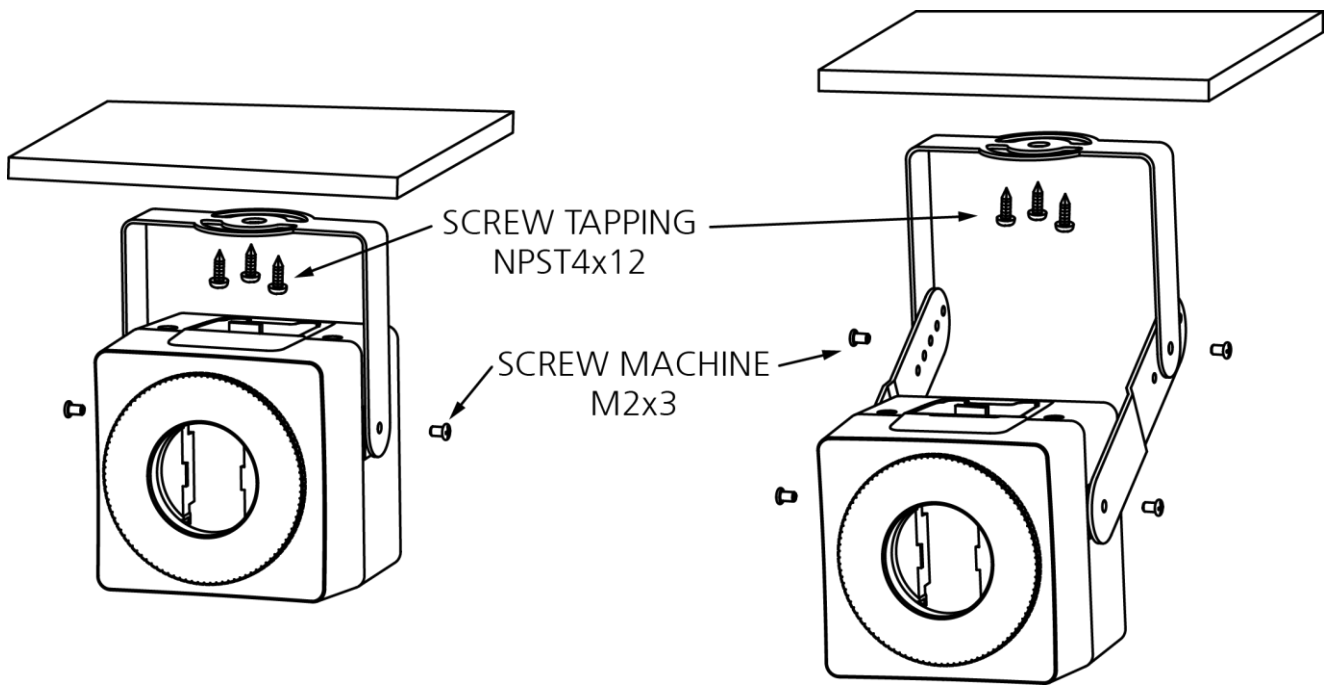

Mounting Brackets (Optional)

• Dimension

< CS mount >

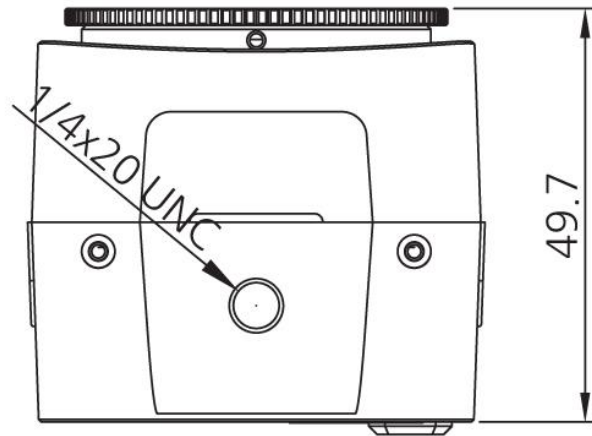
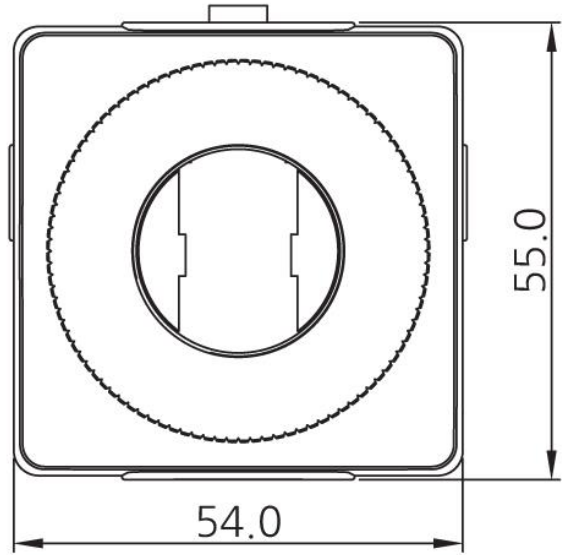
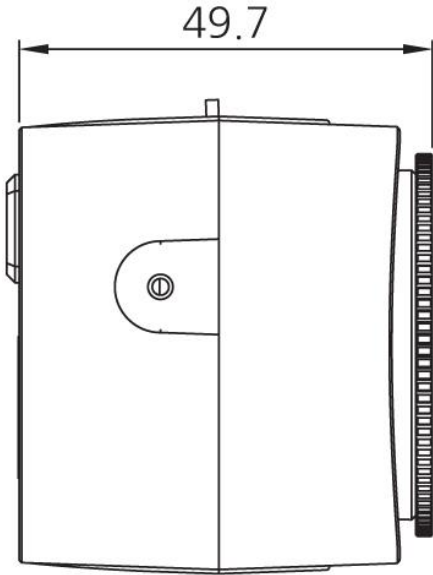

2.2 Micro-SD Card Insertion

- **Micro SD memory card insertion**

User can install and change Micro-SD card as shown in the following picture.

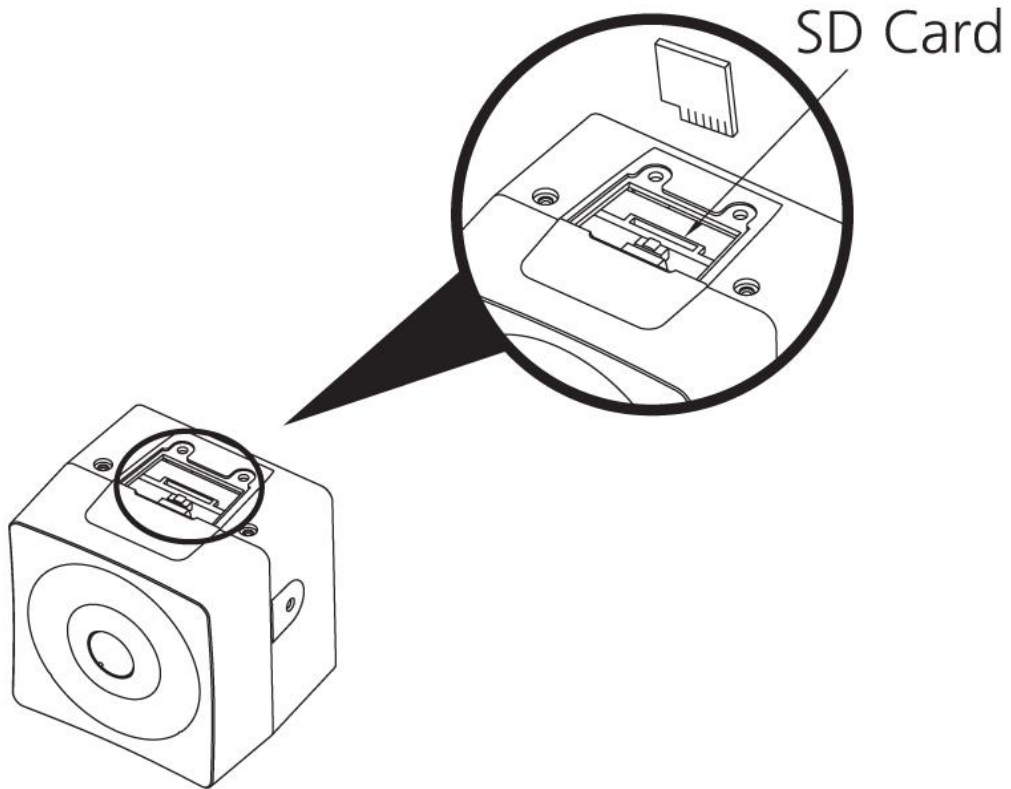

2.3 Connections

- **Connecting the Network**

Connect a standard RJ-45 cable to the network port of the camera. Generally a crossover cable is used for directly connecting to a PC, while a direct cable is used for connection to a hub.

- **Connecting Audio**

Connect audio output line and audio input line.

- **Connecting Alarms**

- **AL_IN (Alarm Input)**

You can use external devices to signal the camera to react on events. Mechanical or electrical switches can be wired to the A1 (Alarm Input 1) and G (Ground) connectors.

- **GND (Ground)**

NOTE: All the connectors marked G or GND are common.

Connect the ground side of the alarm input and/or alarm output to the G (Ground) connector.

- **AL_OUT (Alarm Output)**

The camera can activate external devices such as buzzers or lights. Connect the device to the AO (Alarm Output) and G (Ground) connectors.

- **Connecting the Power**

Connect power of 12VDC for the camera.

When using a 12VDC adapter, connect the positive (+) pole to the '+' position and the negative (-) pole to the '-' position.

Use satisfy clause 2.5 of IEC60950-1/UL60950-1 or Certified/Listed Class 2 power source only.

- Be careful not to reverse the polarity when you connect the power cable.

2.4. Network Connection & IP assignment

The camera supports operation through the network. When a camera is first connected to the network, it is necessary to allocate an IP address to the device with the SmartManager utility on the CD. (Default IP 192.168.0.129)

- 1) Connect the network camera/device to the network and power up.
- 2) Start SmartManager utility (Start > All programs > SmartManager > SmartManager). The main window will display, and after a short while any network devices connected to the network will be displayed in the list.

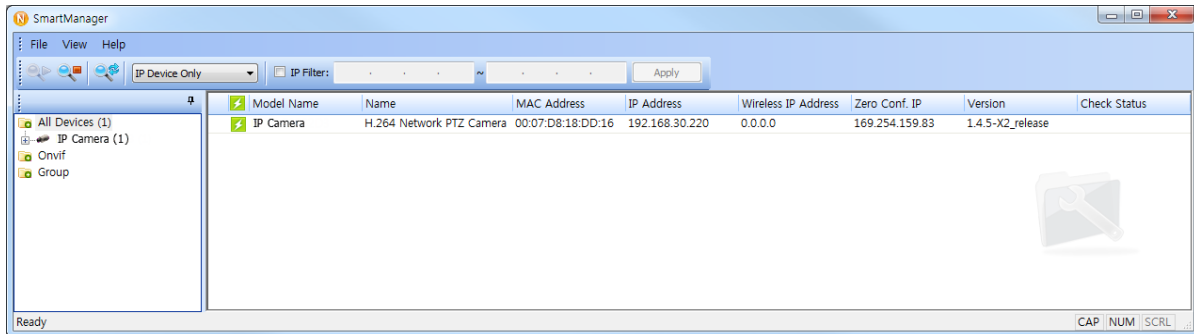

- 3) Select the camera on the list and click right mouse button. You can see the pop-up menu as below.

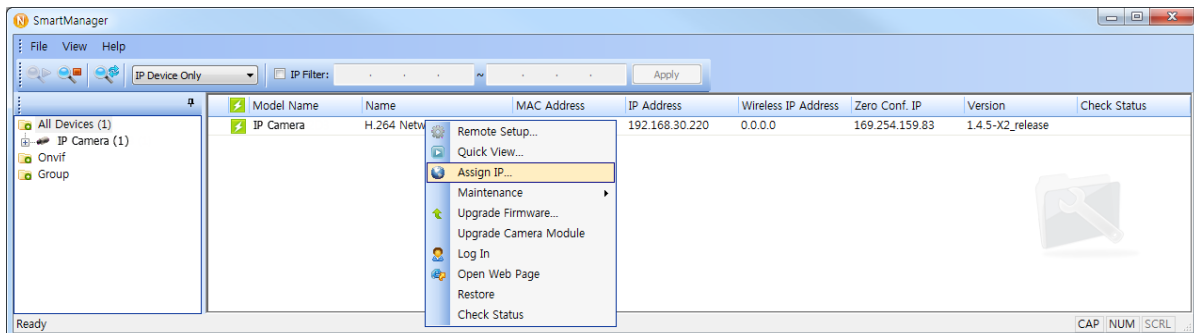

- 4) Select Assign IP Address. The Assign IP window will display. Enter the required IP address.

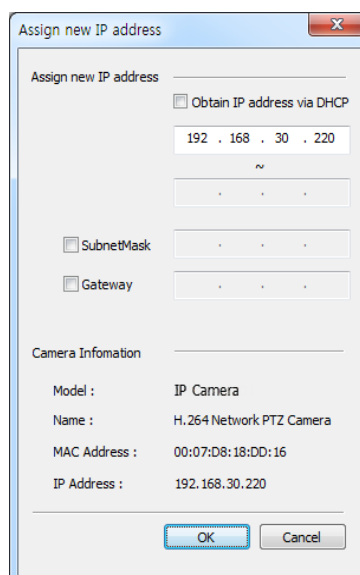

NOTE: For more information, refer to the SmartManager User's Manual.

3 Operation

The network camera can be used with Windows operating system and browsers. The recommended browsers are Internet Explorer, Safari, Firefox, Opera and Google Chrome with Windows.

NOTE: To view streaming video in Microsoft Internet Explorer, set your browser to allow ActiveX controls.

3.1 Access from a browser

1. Start a browser (Internet Explorer).
2. Enter the IP address or host name of the network camera in the Location/Address field of your browser.
3. You can see a starting page. Click **Live View**, **Playback**, or **Setup** to enter web page.



4. The network cameras Live View page appears in your browser.

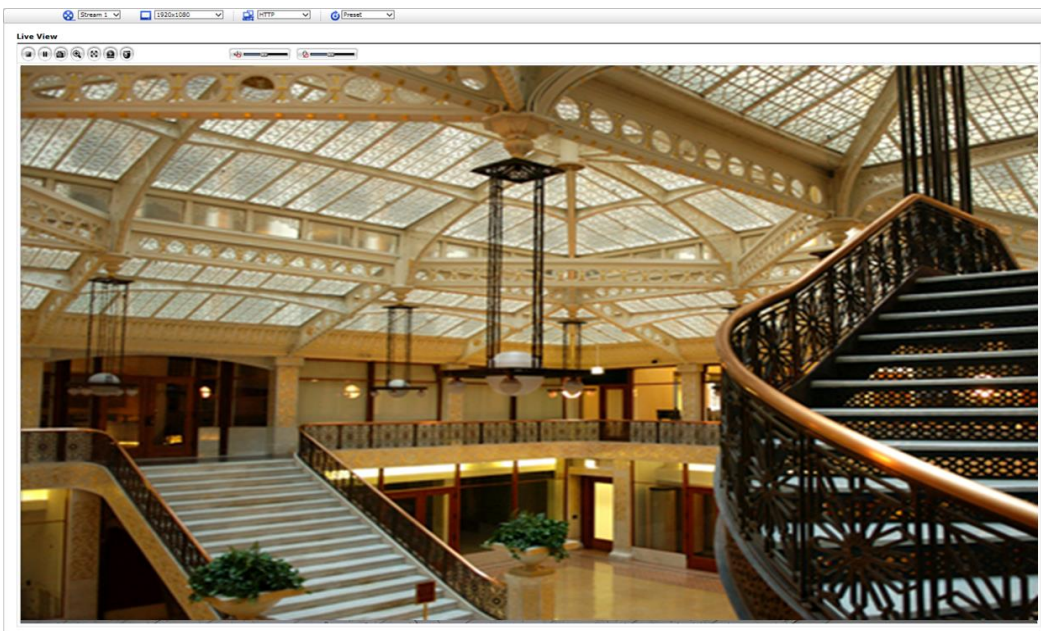

3.2 Access from the internet

Once connected, the network camera is accessible on your local network (LAN). To access the network camera from the Internet you must configure your broadband router to allow incoming data traffic to the network camera. To do this, enable the NAT traversal feature, which will attempt to automatically configure the router to allow access to the network camera. This is enabled from Setup > System > Network > NAT. For more information, please see “System > Network > NAT” of User’s Manual.

3.3 Setting the admin password over a secure connection

To gain access to the product, the password for the default administrator user must be set. This is done in the Admin Password dialog, which is displayed when the network camera is accessed for setup at the first time. Enter your admin name and password, set by the administrator.



NOTE: The default administrator user name and password is admin. If the password is lost, the network camera must be reset to the factory default settings. Please see Resetting to the factory default settings.

To prevent network eavesdropping when setting the admin password, this can be done via an encrypted HTTPS connection, which requires an HTTPS certificate (see NOTE below). To set the password via a standard HTTP connection, enter it directly in the first dialog shown below. To set the password via an encrypted HTTPS connection, please see “System > Security > HTTPS” of User’s Manual.

NOTE: HTTPS (Hypertext Transfer Protocol over SSL) is a protocol used to encrypt the traffic between web browsers and servers. The HTTPS certificate controls the encrypted exchange of information.

3.4 Live View Page

The Live View page comes in several screen modes: 1920x1080, 1280x1024, 1280x720(960), 1024x768, 704x480(576), 640x480(360) and 320x240. Users are allowed to select the most suitable mode for their application needs. Adjust the mode in accordance with your PC specifications and monitoring purposes.

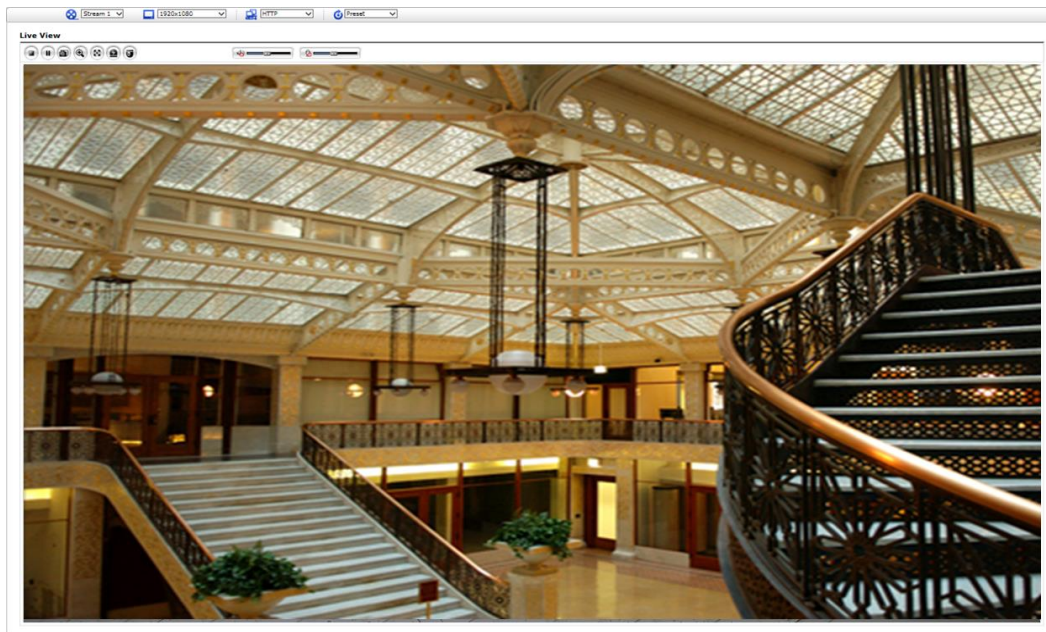

1) General controls



Live View Page



Playback Page



Setup Page



Help Page

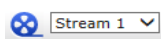

The video drop-down list allows you to select a customized or preprogrammed video stream on the Live View page. Stream profiles are configured under Setup > Basic Configuration > Video & Image. For more information, please see "Basic Configuration > Video & Image" of User's Manual.

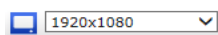

The resolution drop-down list allows you to select the most suitable video resolution to be displayed on Live View page.















The protocol drop-down list allows you to select which combination of protocols and methods to use depending on your viewing requirements, and on the properties of your network.



The preset drop-down list allows you to select the preset number for the PTZ camera being used.

2) Control toolbar

The live viewer toolbar is available in the web browser page only. It displays the following buttons:

-  The **Stop** button stops the video stream being played. Pressing the key again toggles the play and stop.
-  The **Play** button connects to the network camera or starts playing a video stream.
-  The **Pause** button pauses the video stream being played.
-  The **Snapshot** button takes a snapshot of the current image. The location where the image is saved can be specified.
-  The **Digital Zoom** button activates a zoom-in or zoom-out function for video image on the live screen.
-  The **Full Screen** button causes the video image to fill the entire screen area. No other windows will be visible. Press the 'Esc' button on the computer keyboard to cancel full screen view.
-  The **Manual Trigger** button activates a pop-up window to manually start or stop the event.
-  The **PTZ** button activates a pop-up window for Zoom, Focus control and Preset setting.
 - The camera can save and run preset number 1~32.
 - If you select and run Preset 33~256, the preset command will be sent through RS-485 port of the camera.
-  The **VCA** button shows/hides VCA rule setting and detected objects.
-  The **Face Detector** button shows/hides detected faces.
-  The **Speaker** button activates/deactivates external speaker.
-  The **Mic** button activates/deactivates microphone input.
-  Use this scale to control the volume of the speakers and microphones.

NOTE1: VCA and Face Detector buttons appear only when each function is activated.

NOTE2: VCA and Face Detector works exclusively to each other.

3) Video Streams

The network camera provides several images and video stream formats. Your requirements and the properties of your network will determine the type you use.

The Live View page in the network camera provides access to H.264 and Motion JPEG video streams, and to the list of available video streams. Other applications and clients can also access these video streams/images directly, without going via the Live View page.

3.5 Playback

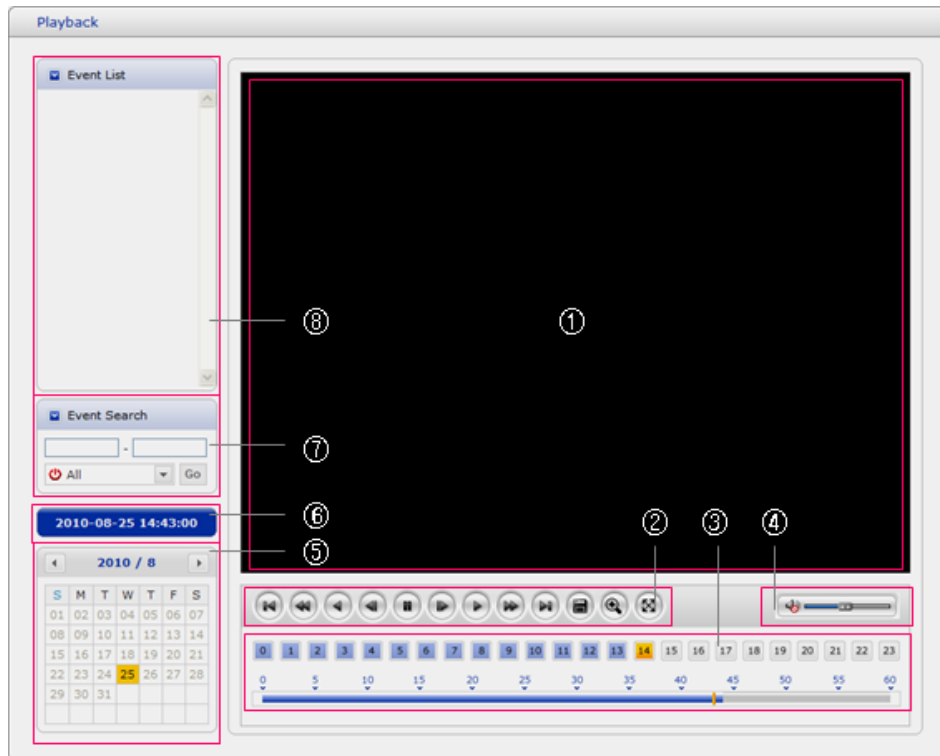

The Playback window contains a list of recordings made to the memory card. It shows each recording's start time, length, the event type used to start the recording, calendar and time slice bar indicates if the recording exists or not.







The description of playback window follows.

1) Video Screen

You can see the video screen when playing the video clip in the Micro SD memory.

2) Playback Buttons

To view recorded data in the SD local storage, select it from the list and click the Playback buttons.

-  Go to the first: go to the beginning of the video clip.
-  Fast backward play: fast play backward of the video clip.
-  Backward play: play backward of the video clip.
-  Step backward play: go back one frame of the video clip.
-  Pause: pause playback of the video clip.
-  Step forward play: go forward one frame of the video clip.
-  Forward Play: play forward the video clip.
-  Fast forward play: play fast forward of the video clip.
-  Go to the last: go to the end of the video clip.
-  Clip copy: copy the video clip.
-  Zoom In: zoom in the video clip.
-  Full Screen: display full screen of the video.

3) Time Chart

Display an hour-based search screen for the chosen date. If there is recorded data, a blue section will be displayed on a 24-hour basis. If you select a particular hour in the chart, a yellow square on the hour will be displayed.

4) Speaker Control Bar

Use this scale to control the volume of the speakers.

5) Search Calendar

Search results from the SD local storage in the network camera connected are displayed monthly. If there is a recorded data for a particular date, a blue square on the date will be displayed. If you select a particular date in the calendar, a yellow square on the date will be displayed.

6) Play Time

Displays time of the video playing.

7) Event Search Window

Select a search option in the drop-down list and click GO button. You can also enter the time period for searching. To display the Calendar search, click Start Date or End Date.

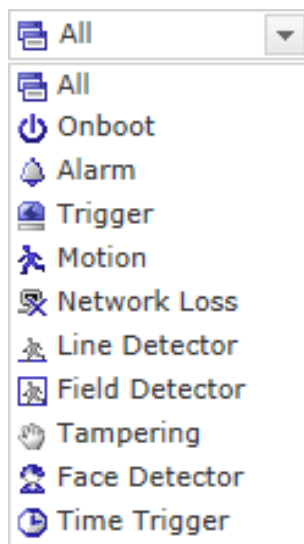

8) Event List Window

Event List displays the event(s) that were recorded in the SD local storage. Select an event and click the play button. The video clip will be played.

3.6 Network Camera Setup

This section describes how to configure the network camera.

Administrator has unrestricted access to all the Setup tools, whereas Operators have access to the settings of Basic Configuration, which are Live View, Video & Image, Audio, Event, Dome Configuration, and System.

You can configure the network camera by clicking Setup either in the first connection page or the top second-right button of the Live View page. Accessing the network camera from a computer for the first time opens the Admin Password dialog box. Enter your administrator or operator ID and password to get into setup page.



NOTE: If the password is lost, the network camera must be reset to the factory default settings. Please see "Resetting to the Factory Default Setting".

3.7 Resetting to the factory default settings

To reset the network camera to the original factory settings, go to the Setup > System > Maintenance web page (described in “System > Maintenance” of User’s Manual) or use the **Reset** button on the network camera, as described below:

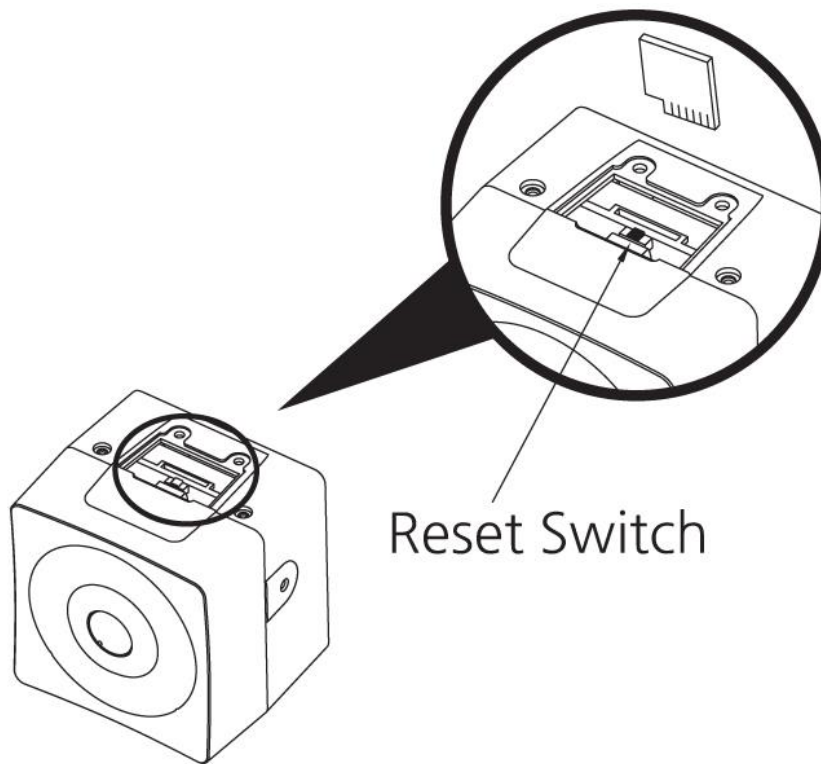

• Using the Reset button:

Follow the instructions below to reset the network camera to the factory default settings using the Reset button.

1. Switch off the network camera by disconnecting the power adapter.
2. Press and hold the Reset button on the board with your finger while reconnecting the power.
3. Keep the Reset button pressed for about 2 seconds.
5. Release the Reset button.
6. The network camera resets to factory defaults and restarts after completing the factory reset.

CAUTION: When performing a Factory Reset, you will lose any settings that have been saved. (Default IP 192.168.0.129)

System Requirement for Web Browser

- **Operating System:** Microsoft Windows OS Series
- **CPU:** Intel Core 2 Duo 2GHz or higher, 1GB RAM or more, 10GB free disk or higher
- **VGA:** AGP, Video RAM 32MB or higher (1024x768, 24bpp or higher)

General Performance Considerations

When setting up your system, it is important to consider how various settings and situations will affect performance. Some factors affect the amount of bandwidth (the bit rate) required, others can affect the frame rate, and some affect both. If the load on the CPU reaches its maximum, this will also affect the frame rate.

The following factors are among the most important to consider:

- High image resolutions and/or lower compression levels (or high bitrates) result in larger images. Frame rate and Bandwidth affected.
- Accessing both Motion JPEG and H.264 video streams simultaneously. Frame rate and bandwidth affected.
- Heavy network utilization due to poor infrastructure. Frame rate and Bandwidth affected.
- Heavy network utilization via wireless router due to poor infrastructure. Frame rate and bandwidth affected.
- Viewing on poorly performing client PCs lowers perceived performance. Frame rate affected.

4 Product Specification

Model		CS Mount NETWORK CAMERA	
IMAGE	Lens	-	
	Angle of View	-	
	Image Sensor	Type	1/2.8" SONY Exmor CMOS sensor
		Pixels	2000(H) x 1241(V)
	Min. Illumination	Color : 0.04 Lux @ F1.2, 50IRE BW : 0.01 Lux @ F1.2, 50IRE	
	Scanning Mode	Progressive Scan	
	Wide Dynamic Mode	True WDR (120dB)	
	Noise Reduction	2DNR, 3DNR	
	Digital Zoom	Yes (ROI)	
	Exposure Control	Auto	
	White Balance Control	Auto, Incandescent, Fluorescent, Outdoor	
	Back Light Compensation	Yes	
	Image effect	Flip, Mirror, Aisle	
	Flicker Free Mode	50Hz, 60Hz	
Shutter Speed	Auto(1/10,000 ~ 1sec), Manual		

VIDEO/AUDIO	Compression	H.264(Baseline, Main, High Profile), MJPEG		
	Bitrate Control	CVBR, VBR		
	Resolution	1920x1080, 1280x1024, 1280x720/960, 1024x768, 704x480/576, 640x360/480, 320x240		
	Frame Rate		Max. 50fps/60fps	
	Streaming		50/60fps (Dual Stream : H.264 x 1, MJPEG x 1) 25/30fps (Triple Stream : H.264 x 2, MJPEG x 1)	
	Composite Out		Yes(25/30fps Mode)	
	Audio Compression	G.711		
	Audio Streaming	2 Way		
SYSTEM	Video Contents Analysis	DIS, Defog, Face Detector, Tampering, Line Detector, Field Detector		
	Motion Detection Area	16 Programmable Area (Include Area 8, Exclude Area 8)		
	Privacy Mask Zone	8 Programmable Zone		
	FTP Uploading	MJPEG		
	Event Notification	E-mail, FTP, Notification Server, XML Notification, Audio Alert, AIHM		
	Audio Alert	User-Defined 3 Audio files		
	Login Authority	Administrator, Operator, Guest		
	Event Buffering	FTP	Pre : 30sec, Post : 30sec	
		SD Record	Pre : 10sec, Post : 60sec	
	Manual Trigger	4 Programmable Trigger		
	Security	Multi User Authority, IP Filtering, HTTPS, SSL		
	Network Time Sync	NTP Server, Synchronized Computer, Manual		
	Software Reset	Restart, Reset, Factory Default		
	Hardware Factory Reset	Yes		
	Auto Recovery	Backup, Restore		
	Remote Upgrade	Web Browsing(IE, Chrome, Safari, Firefox), Smart Manager		
SD Recording Mode	Event, Continuous			
NETWORK	Protocols	TCP/IP, UDP, IPv4/v6, HTTP, HTTPS, QoS, FTP, UPnP, RTP, RTSP, RTCP, DHCP, ARP, Zeroconf, Bonjour		
	Client Software	Web, SmartManager, Client S/W, Mobile S/W		
	Max. User Connection	Live : 10 Users, Playback : 3 Users		
	API Support	Open API, ONVIF Compliance		
	Mobile Support	Android, i-OS		
EXTERNAL IN/OUT	Video Composite Out	1 Output	1 Output(25/30fps Mode)	
	Audio	1 Input, 1 Output		
	Alarm	1 Input, 1 Output		
	Ethernet	RJ-45 (10/100Base-T)		
	u-SD Card	SDHC (Max. 32GB)		
ETC	Operating Humidity	0 ~ 90% RH (Non-condensing)		
	Operating Temperature	-10℃ ~ +50℃		
	Power Supply	PoE(IEEE802.3af compliance, Class0), 12VDC		
	Power Consumption	120mA(5.8W) @ PoE, 370mA(4.5W) @ 12VDC		
	Dimensions	54(W)mm x 55(H)mm x 49.7(D)mm		
	Net Weight	155g(Unit)		

* Specifications are subject to change without notice.

Full-HD NETWORK SQUARE CAMERA



50303998B