

# BMA 360

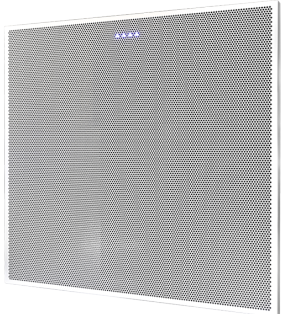

The BMA 360 with Voice Lift and Camera Tracking technology is the world's most technologically advanced beamforming microphone array ceiling tile delivering unrivaled audio performance and deployment ease.

- > The industry's only ultra wideband, frequency-invariant beamforming mic array with uniform gain response across all frequency bands. With 6G Acoustic Echo Cancellation (AEC) and FiBeam™ technology, conference participants experience natural and full-fidelity audio across all beams and within a single beam
- > A dramatically new approach to precision beamforming provides a new beam topology to easily achieve distortion-free, full 360-degree coverage of any room shape and any seating arrangement using ClearOne *Audio Intelligence*™.
- > The BMA 360 Voice Lift feature provides a powerful and simple way to drive multiple mix-minus speaker zones allowing everyone in the local room to hear every word.
- > Due to the exceptional performance of the breakthrough technologies, FiBeam and DsBeam, greater Voice Lift gains can be realized that have not been previously possible.
- > The combination of ClearOne's beamforming and feedback cancellation technologies provide up to a 20 dB boost in gain before feedback compared to an omni mic.
- > Further advancements in adaptive steering (think of it as smart switching) provide impeccable coverage of each conference participant as well as simultaneous support for camera tracking and Voice Lift.
- > 6G Acoustic Echo Cancellation (AEC) delivers unparalleled per-beam full-duplex audio performance. On-board audio algorithms, like noise reduction, filtering, and Automatic Level Control, eliminate the need for per-beam processing in a DSP mixer - requiring fewer DSP mixer resources.
- > Built-in, robust power amplifiers, configurable as 4 x 15 Watt or 2 x 30 Watt, provide flexibility for driving loudspeakers.
- > ClearOne's breakthrough technologies, FiBeam, DsBeam, Voice Lift, and 6G AEC combine to create VividVoice™, a significant advancement for professional conferencing.
- > Integrated features significantly reduce system design complexity, simplify installation, consume less rack space, and lower system cost.
- > Daisy-chain up to three ceiling tiles via P-Link for divisible rooms or larger conference setups – for simpler wiring and longer distances compared to networked “home run” connections via Ethernet.
- > Single workflow for configuration using CONSOLE® AI software. Competing products require practitioners to program multiple components using different toolsets: Ethernet switches, Ceiling Tiles, DSP mixers, and the Dante Controller.
- > Supports three different ceiling grid types: 24 in, 600 mm, and 625 mm. It incorporates a VESA-mount hole pattern that supports pole mounting. Hard-ceiling mount adapter kits are also available.<sup>2</sup>

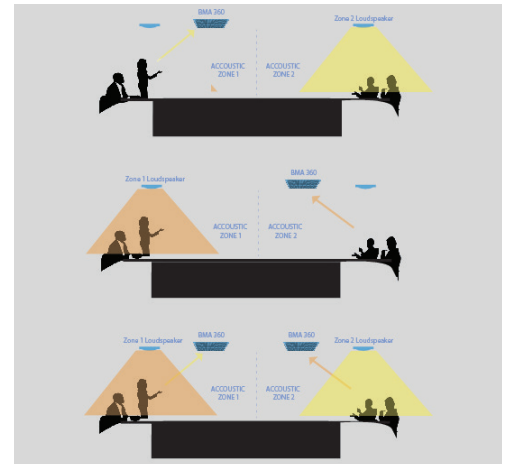

### Voice Lift

Voice Lift provides a powerful and simple way to drive multiple mix-minus speaker zones allowing everyone in the room to hear every word. Due to the exceptional performance of the breakthrough technologies, FiBeam and DsBeam, greater Voice Lift gains can be realized that have not been previously possible.

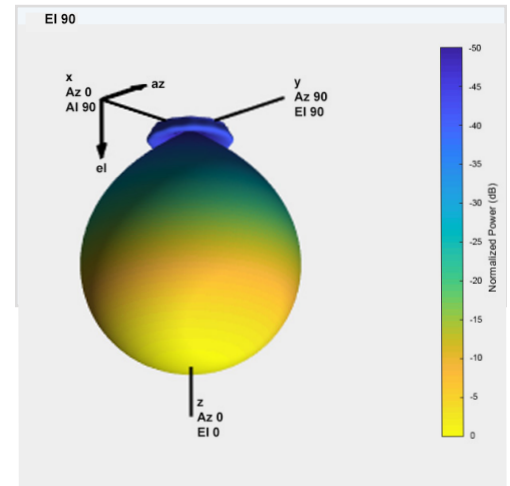

### Deep Sidelobe Beamforming

Deep Sidelobe Beamforming, DsBeam™, provides unparalleled sidelobe depth, below -40 dB, resulting in superior rejection of reverb and noise, even in difficult spaces, for superb clarity and intelligibility.

### APPLICATIONS

- Audio Conferencing
- Video Conferencing
- Voice Lift

### WORKSPACES

- Conference rooms
- Boardrooms
- Courtrooms
- Classrooms
- Telemedicine Theaters

*You're not beamforming unless you're beamforming with ClearOne!™*

### Voice Lift

The BMA 360 FiBeam and DsBeam technologies enable a 12 dB increase in gain before feedback compared to an omni mic.

Voice Lift is further enhanced with the patented DARE™ Feedback Eliminator, found on CONVERGE® Pro 2 DSP Mixers. This technology provides unsurpassed removal of feedback and ringing--giving an additional boost of up to 8 dB to the total system gain.

The amazing sound of FiBeam and DsBeam, combined with the superior CONVERGE Pro 2 Feedback Eliminator, creates the industry's absolute best Voice Lift system provided by any ceiling mounted microphone, including beamforming microphone arrays.

Voice Lift can be configured on up to three BMA 360s per CP2.

The BMA 360 can switch on as many as two beams at one time, which enables better pickup of local presenters that are speaking at the same time.

To help ensure the very best possible design of a ClearOne Voice Lift system, a BMA 360 Voice Lift Design Guide, a BMA 360 PAG/NAG calculator, and a BMA 360 DARE Configuration Guide are available from clearone.com.

These supporting documents show how to properly design and setup a BMA 360 Voice Lift system--helping to achieve the very best-sounding installation.

### Multi-Zone Voice Lift Example

This example shows that the speaker audio in each zone is the mix of all of the audio minus the audio from that zone. This "mix-minus" audio routing is a key component that enables BMA 360 multi-zone Voice Lift.

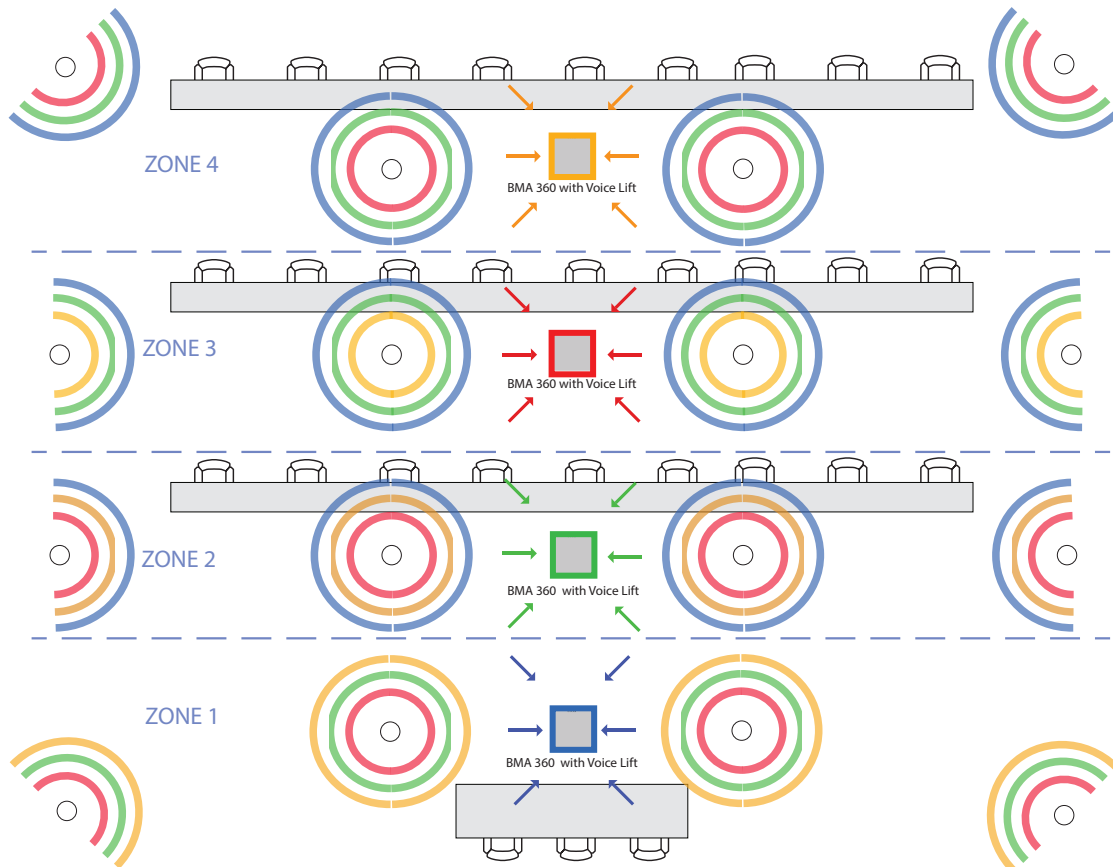

## MICROPHONES

### Connections

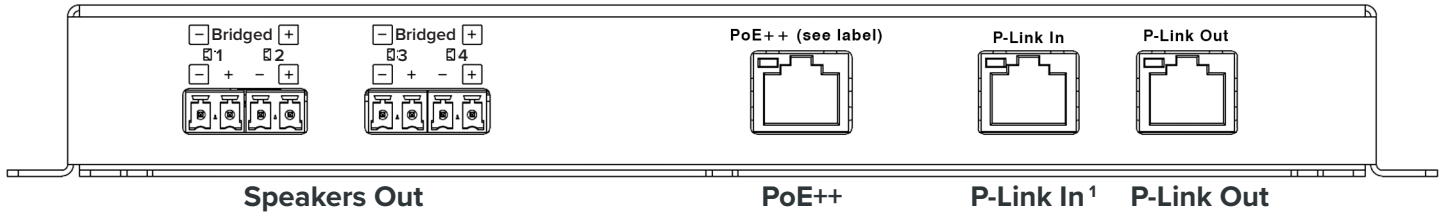

**Note 1:** International Version (Part No. 910-3200-208-I) P-link input port is shown in drawing above.  
US Version (Part No. 910-3200-208-U) P-Link input is accessed through a permanently connected CAT 6 pigtail cable that is terminated with an RJ-45 receptacle.

### System Diagram

Three daisy-chained BMA 360 microphone arrays, with 2x30W and 4x15W speaker configurations, connected to a CONVERGE Pro 2 DSP.

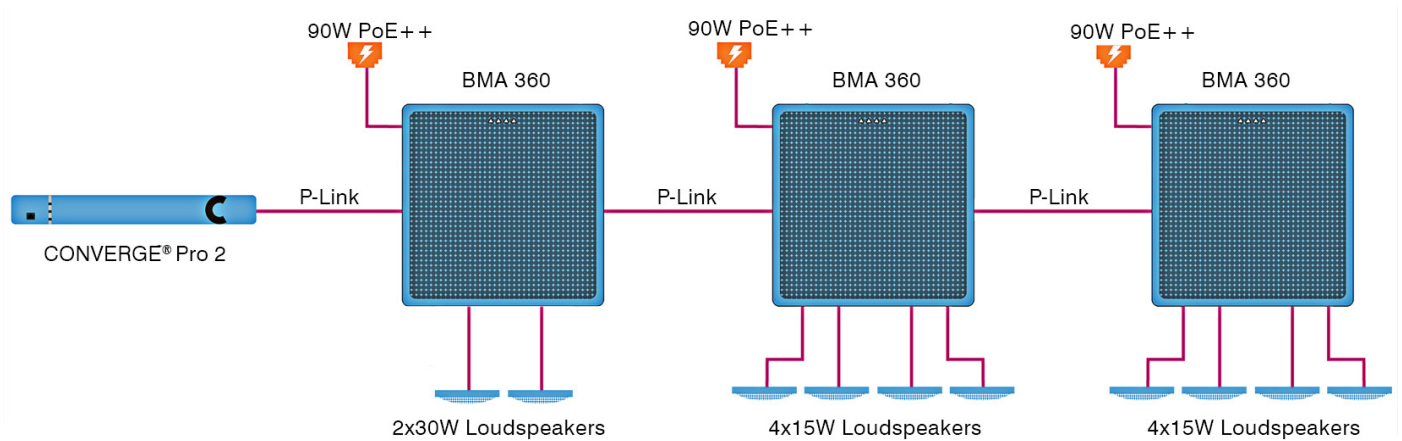

### Configuration

BMA 360 Configuration with ClearOne's CONSOLE AI software.

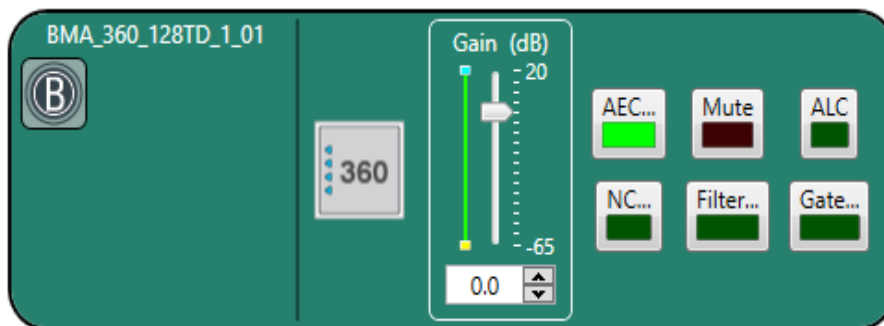

### Room Coverage

**Full Circle/Square**

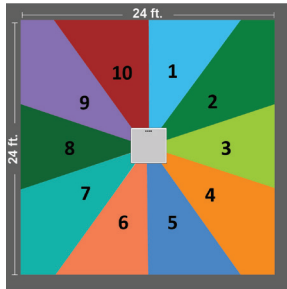

Room size	Beams
10' x 10' to 18' x 18'	6
12' x 12' to 20' x 20'	8
22' x 22' to 24' x 24'	10

**Rectangular**



Room size	Beams
10' x 14' to 18' x 22'	6
10' x 16' to 18' x 24'	8
12' x 22' to 20' x 36'	12

**Semi-Circle/Classroom**

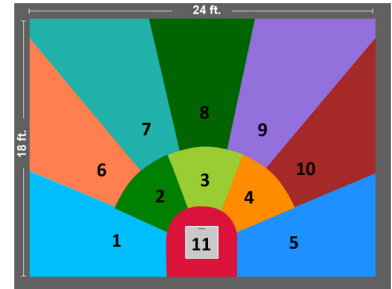

Room size	Beams
16' x 8' to 22' x 16'	6
24' x 18'	11

**Note:** The example room sizes are based on a 10 ft. ceiling.

### Frequency Invariant and Deep Sidelobe Beamforming

**Typical Beamforming**

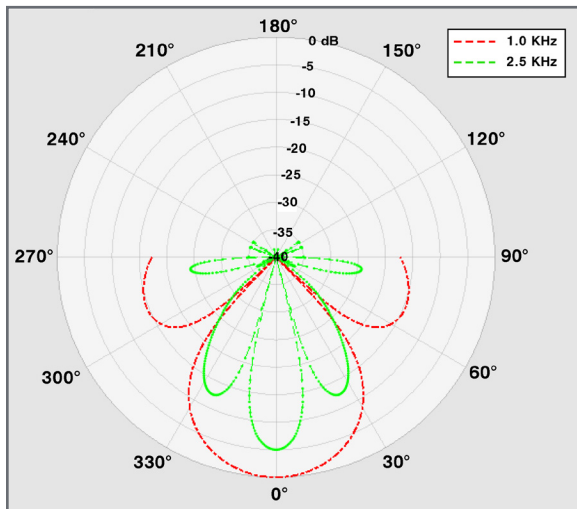

A set of polar plots illustrating a beamformer with gain and coverage that vary with frequency, and that has unwanted large sidelobes.

**ClearOne BMA 360 Beamforming with FiBeam and DsBeam**

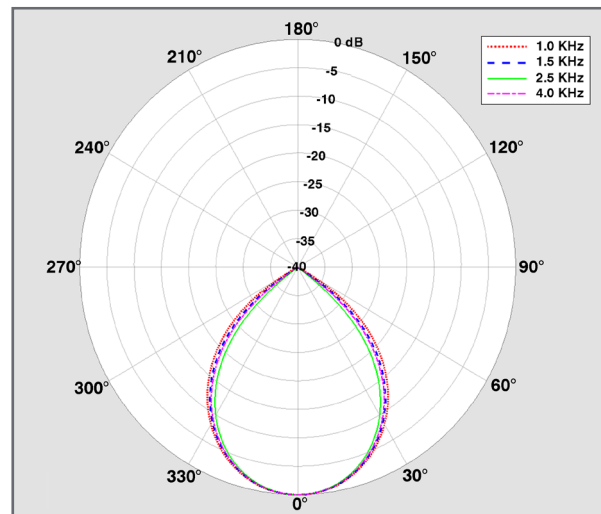

A set of polar plots of the BMA 360 beam performance. These plots show that the pickup pattern is frequency invariant with ultra-low sidelobes below -40 dB.

## MICROPHONES

### Polar Plots (Broadside)

Typical Far Field Performance

Narrow Beam, HPBW = 35°

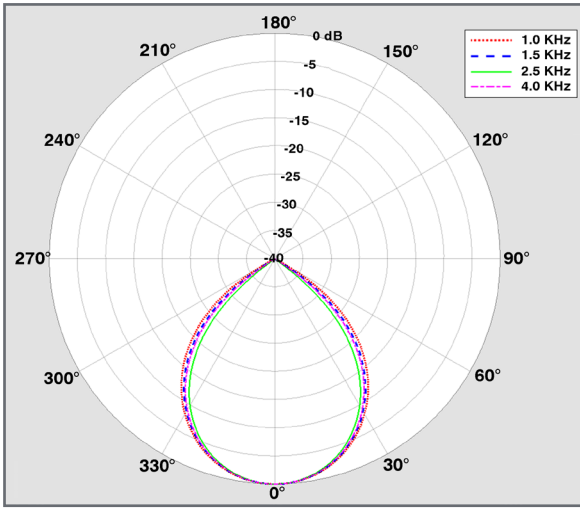

Medium Beam, HPBW = 45°

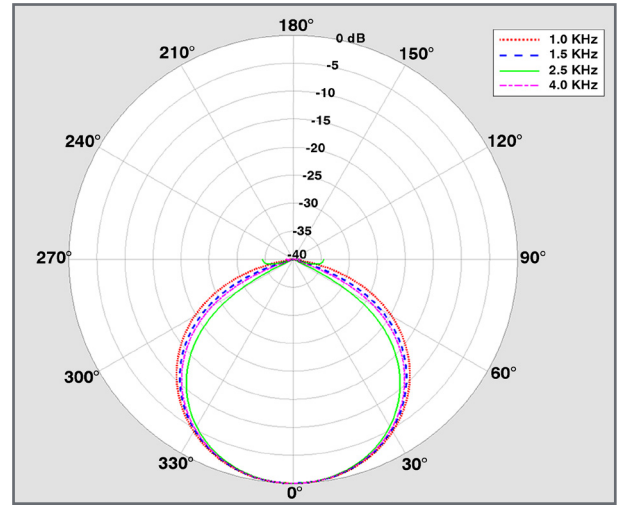

Wide Beam, HPBW = 55°

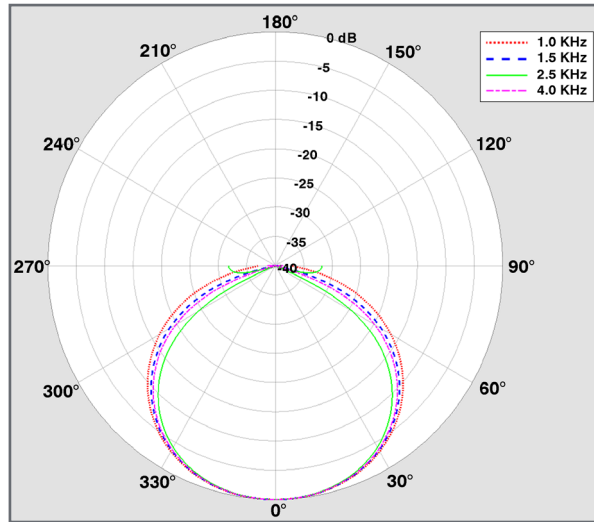

Gain response is frequency invariant for all beamwidths.

HPBW = Half Power Beamwidth

### Frequency Response (Broadside)

Typical Frequency Response

Frequency response measured directly on-axis from a distance of 2 meters.

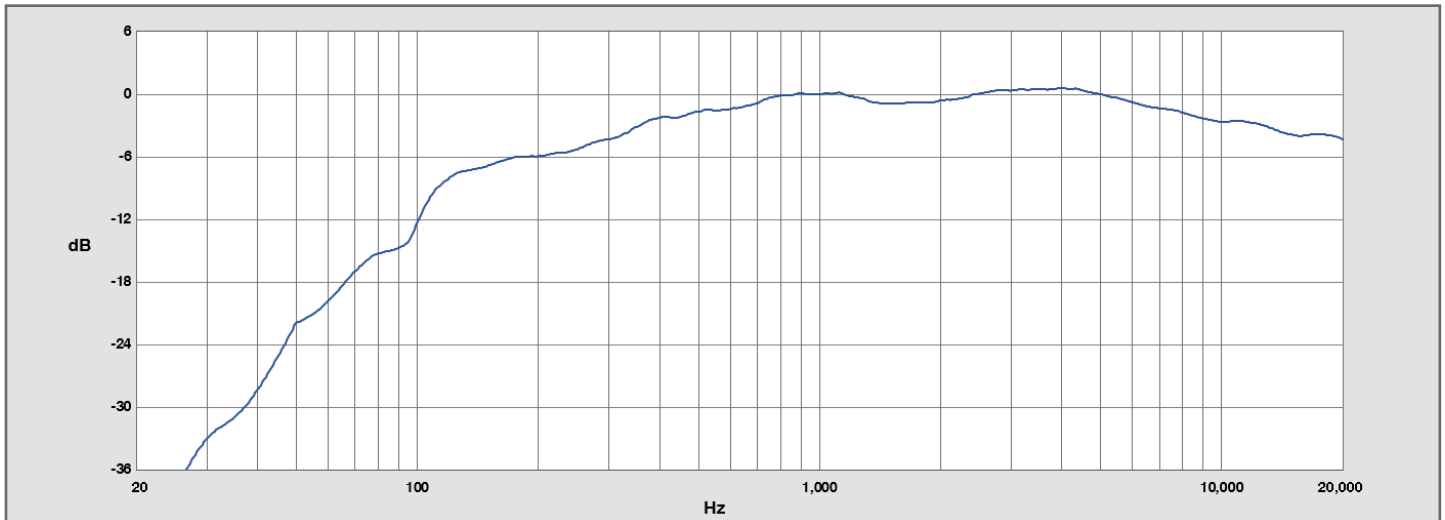

## BMA 360

**BEAMFORMING FEATURES**

- True Frequency Invariant Beamformer: Gain response is unvarying across frequency
- Beamwidths: 35°, 45° and 55° with Frequency Invariance
- Beamforming Range: 100 Hz to 20 KHz
- Deep Sidelobes: Down to 45 dB of depth
- Beam Pointing Accuracy: 0.2 dB
- Dynamic Range: 20 Hz to 20 KHz, > 70 dB
- Number of Beams: 6, 8, 10, 11, or 12
- Room Patterns: Full Circle/Square, Rectangular, Semi-Circle/Classroom
- Coverage Sizes: 24 sizes from small 10 ft x 10 ft up to extra large 36 ft x 20 ft
- Ceiling Height: Configurable with CONSOLE AI from 7 ft to 20 ft

**AMPLIFIER OUTPUT**

- Type: 5.08 mm Header, Phoenix-type Euroblock
- Audio: 4 channels
- Output Power: 4x15 W Max, 8 Ω load, or 2x30W, 4 Ω load, Bridged
- Frequency Response: 20 Hz – 22 kHz, +/- 0.5 dB

**CONFIGURATION**

- Acoustic Echo Cancellation (AEC) On/Off
- Noise Cancellation (NC) on/off. Range: 6 to 25 dB depth.
- Automatic Level Control (ALC) On/Off
- Gain Adjust
- Mute On/Off

**SOFTWARE**

- CONSOLE® AI

**DIMENSION & WEIGHT**

- 24 in:  
23.72 x 23.72 x 2.13 in (602.5 x 602.5 x 54.1 mm)
- 600 mm:  
592.5 x 592.5 x 54.1 mm (23.33 x 23.33 x 2.13 in)
- Product Weight: 9 lbs (4.1 kg)
- Shipping Weight: 12.85 lbs (5.83 kg)

**MOUNTING**

- Ceiling Mount: 24 in, 600 & 625 mm drop-ceiling grid
- VESA® Mount ready: 100 mm hole pattern, M4x10 mm

**P-LINK PERIPHERAL BUS PORT**

- Ports Type: RJ-45
- P-Link In and Out: Proprietary peripheral bus
- P-Link Power
- 56 V 36 W IEEE 802.3at compliant devices or equivalent, Mode B

- Cable: Solid core 23AWG, factory terminated Cat6
- Distance
- Normal distance mode: Up to 200 ft (60 m)
- Long distance mode: To be supported with a future firmware upgrade.

**PoE ++ PORT**

- Port Type: RJ45 PoE power
- Power on all pairs
- 56 V 90 W IEEE 802.3bt compliant devices or equivalent, Mode A and B, Midspan
- Cable: Solid core, 23AWG, factory terminated Cat6

**PoE REQUIREMENTS**

- No speakers: 36 W PoE, connected via P-Link or PoE++
- Speakers: Requires 56 V 90 W IEEE 802.3bt PoE, must be via direct PoE++ port on the BMA 360

**POWER SELECTION**

- Automatically senses and switches to whichever input port has PoE power

**POWER AND THERMAL**

- Power Source: PoE injector or equivalent
- Power Consumption:
- 100-240 VAC, 50/60 Hz
- 23 Watt typical without speaker amp
- 55 W at 1/3 power x 4 @ 1kHz
- Thermal: 270 BTU/hr at max power
- Operating Temperature: 14 °F/-10 °C to 104 °F/40 °C ambient temperature

**ACCESSORIES**

- 910-3200-202 PoE Power supply kit, 36 W
- 910-3200-207 PoE Power supply kit, 70 W
- 910-3200-209 PoE Power supply kit, 90 W
- 910-3200-205-AI Brackets, convert 600 to 625 mm
- 910-3200-208-CB BMA CT Conduit Box

**MOUNTS FOR NON-TILE CEILINGS**

- 910-3200-210 BMA 360 Surface-Mount Kit 24 in
- 910-3200-210-I BMA 360 Surface-Mount Kit 600 mm
- 910-3200-212 BMA 360 Recessed-Mount Kit 24 in
- 910-3200-212-I BMA 360 Recessed-Mount Kit 600 mm

**PART NUMBERS**

- 910-3200-208-U BMA 360
- 910-3200-208-I BMA 360 INTERNATIONAL

<sup>2</sup>Ceiling Tile Beamforming Mic Arrays can be painted to match any space. An instructional video showing how to paint the BMA 360 can be found at [clearone.com/paintmybma](http://clearone.com/paintmybma)

**SALES AND INQUIRIES****Headquarters**

5225 Wiley Post Way  
Suite 500  
Salt Lake City, UT 84116

**US & Canada**

Tel: 801.975.7200

**International**

Tel: +1.801.975.7200

**Sales**

Tel: 801.975.7200  
[sales@clearone.com](mailto:sales@clearone.com)

**Tech Support**

Tel: 801.974.3760  
[audiotechsupport@clearone.com](mailto:audiotechsupport@clearone.com)