



WIRELESS VEHICLE DETECTION AT ITS BEST!!!

THE BASICS

- 1) A sensor(s) detect(s) a vehicle entering monitored area(s) . Up to 3 may be used in different areas.
- 2) A control panel up to 1000 feet away receives a signal from the sensor and triggers an alert inside the home or business (booster antenna increases range to 3/4-mile)

MORE OPTIONS

- 3) Add remote plug-in chimes in the front room, basement, upstairs, back yard, by the pool, or in other buildings
- 4) Set the DA-700s Timer Relay to turn on outdoor and indoor lights to warn strangers or welcome friends
- 5) Activate video surveillance to record activity and display the driveway on a monitor
- 6) Activate signs, gates, alarm panels or other equipment
- 7) Add a repeater to send the signal another 1000 feet to trigger alerts in other buildings, or add a DA-660 booster-antenna for buildings up to 3/4-mile away
- 8) Monitor up to three different driveways and/or areas with different alert chimes or signals for each

DA-700 Instruction Manual

Page(s)	Content
2	Product Features
3	Quick Installation Page
4-6	Sensor & Transmitter Comprehensive Installation
7	Control Panel/Receiver Comprehensive Details of Functions
8	Control Panel/Receiver Programming the Timers or the Mute Function
9-11	Control Panel/Receiver Hooking Up Chimes, Lights and Accessories
12	Accessories
13	Long Range Installation Options
14	Supplemental Information
15-16	Troubleshooting
17	Technical Support Information and Warranty



DA-700



DA-700-611

DA-700 and DA-700-611 Wireless Drive-Alert Features

Mier's DA-700 and DA-700-611 Wireless Vehicle Detection Systems include:

- Control Panel/Receiver with Additional Form C Dry Contacts
- Sensor/Transmitter
- Internal chime with volume control and choice of three (3) different chimes
- Zoning capability to monitor up to three (3) different areas
- Ability to mute alerts for a timed period with internal button or with an accessory button
- +24 and +12 volt DC power sources for use with accessories
- Relay output available for use with accessories, including two (2) programmable timers
- Visible POWER LED to monitor power status and LO BATT LED to monitor Transmitter batteries
- User accessible address switches to set a unique address code between the Control Panel/Receiver and the Sensor/Transmitter
- Normal reception to 1000 feet, or 3/4-mile if using the DA-660 Booster Antenna (see Options For Long Range Installations page)
- Use of an unlimited Wireless Sensor/Transmitters (DA-610TO, DA-611TO, DA-612TO) with a DA-700 Control Panel/Receiver
- Compatible with Mier Accessories detailed in this manual (See Accessories Page), as well as many after-market accessories
- Compatible with and interface with many security panels and systems (call our tech support for assistance)
- UL Listed switching mode power supply, isolated from ground, with input voltage of 100 to 240 50/60HZ, which provides better lightning rejection. Output regulation of 24VDC +/- 0.5A with output short circuit protection with current limit until fault is cleared.

DA-700



DA-700-611



REMEMBER, you are welcome to contact our Tech Support Team and we will be happy to “Google™earth” your installation site, and provide you with information on the products needed, and locations for each piece to meet your installation/application goals.

Don't forget to check out our website for cut-sheets, installation manuals, installation examples, and information on more products!

DA-700 and DA-700-611 Quick Test & Installation



Installation is often completed in under 30 minutes



Plug-In the Control Panel inside

Place the Sensor-Transmitter outside

First, BENCH TEST both Pieces in the Same Room:

1. Plug in the white DA-700 Control Panel/Receiver (shown top left, above), and turn the Chime On/Off/Volume Knob all the way up (the knob is on top). Keep the door open for testing.
2. Install two (2) AA batteries in the black Sensor/Transmitter box (shown top right, above), we recommend Energizer Lithium AA, observe polarity, and turn it on in the same room as the DA-700 Control Panel/Receiver. Keep the cover off for testing.
3. Switch the Sensor/Transmitter to the ON position and the Valid Transmit LED (XMIT) will come on. It will send a signal to the Control Panel/Receiver and you should hear the alarm chime inside the Control Panel/Receiver.
4. Test all 3 chime tones in the Control Panel using the SW2 tone switch to choose a desired tone. Turn the on/off to hear each.
5. Move the Sensor/Transmitter, or waive something metal over it, in different locations to continue to test.

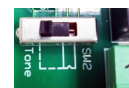

Now that you've bench tested, follow these steps to install:

6. Place the Control Panel/Chime and the Sensor/Transmitter where desired (see the following pages for tips and photos).
7. DO NOT Permanently Mount The Sensor/Transmitter initially. Test the location for a week before deciding to permanently mount.
8. If you are just monitoring one area with just one sensor, you won't need to worry about Zone jumpers. However, IF using more than one Sensor/Transmitter to monitor more than one zone/area, pull the black jumper off of the JP3 pin in the Control Panel/Receiver (see page 7). You don't need to do anything else in the Control Panel.



Then, assign each Sensor/Transmitter a Zone by placing a jumper on the Zone Pins within (see page 6) Ex: if monitoring 3 driveways put a jumper on Zone 1 Pin for Zone 1 in the first Transmitter, on Zone 2 Pin for Zone 2 in the second, and Zone 3 Pin for Zone 3 in the third. The Control Panel will now respond with a different chime for each Zone. Test by turning on one Sensor/Transmitter at a time like you did in step 3 above. The Control Panel will not chime if all three transmitters send a signal at the same time.



9. In most cases you don't have to worry about Addressing. The Control Panels and Sensor/Transmitters are set at the same address at the factory. However, IF a neighbor also has a wireless Drive-Alert and you don't want alerts from their system, put a jumper on corresponding Addressing Pins on both the Control Panel and Transmitter (see pages 6 and 7) Ex: A1 on the Control Panel and A1 in the Transmitters.

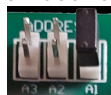

The DA-700 Control Panel/Receiver is to be mounted indoors, 4-6 feet above ground level, where 110 volts AC power is available. To maximize transmitter reception, the antenna is to be at least 12 inches from any metal pipes, power conduits, breaker boxes, etc. Simply plug the Control Panel/Receiver into a standard wall outlet, where the signal from the outside Sensor/Transmitter can reach it.

The relay contacts on the terminal board are Form C dry contacts. These contacts may be supplied with 24 or 12 VDC with the addition of a jumper from the needed voltage to the C terminal. The Control Panel will operate any of Mier's Drive-Alert accessories listed on the "Accessories" pages of this manual. It can also be used to control other external bells, surveillance systems, signs, gates and relays. An adjustable time control provides from as low as 1.5 seconds up to 1 hour of relay closer for each vehicle detected. Pages 7-11 show examples of hooking up external equipment, including Mier's accessories, to be triggered by the DA-700 when a vehicle is detected.



More comprehensive installation instructions are on the following pages. See the Long Range Options page for ranges up to 8/10 mile.

Wireless Drive-Alert Sensor/Transmitter Installation Guide

DA-610TO



Mier Products' Wireless Drive-Alert Sensor/Transmitters detect changes in the magnetic field (movement of metal) within 14 feet in every direction, based on a sedan traveling 5mph. They will not false-alarm from animals, wind, rain, etc. The Transmitter electrical boards are epoxied and also encased in a durable, weather-sealed, NEMA 4X box for worry free weather and corrosion protection. They are able to detect through standard building materials such as brick, stone, vinyl siding, etc. so in many drive-up window applications they may be installed inside the wall next to the drive. They are powered by two AA batteries, Lithium are recommended, and include circuitry to transmit a low-battery condition to Mier's Drive-Alert Control Panel/Receivers when batteries begin to run low.

DA-611TO



The Sensor (aka: probe or wand) portion of any of these Sensor/Transmitters should be placed next to the drive or area to be monitored, and at least 50 feet from any road traffic to prevent false alarms (see next page). The Sensor should be parallel to the drive. Any movement of the Sensor will cause an alarm for asset protection (ex. a tractor, a trailer, gas pump, etc).

The range from the Transmitter to the Control Panel is 500 feet if placed on the ground, up to 1000 feet if mounted 2 to 4 feet high on a wood or concrete post (never metal posts) or a convenient building, and up to 3/4-mile if a DA-660 Reception Booster Antenna is used. (See the Long Range Options page to learn more about the booster antenna, adding repeaters, or adding additional control panels)

DA-612TO



If occasional false alarms occur, or you are not detecting some vehicles, you can try re-locating the Sensor, or you can reduce sensor sensitivity (see photo on page 6). There is a small blue sensitivity-dial on the electrical board. Maximum sensitivity adjustment is clockwise and minimum is counter-clockwise (note arrow direction). Reducing sensitivity would reduce detection of road traffic, but would also reduce the detection sensitivity in the driveway. (See next two pages for directions)

Lightning strikes cause a large disturbance in the magnetic field, so nearby strikes will cause an alarm. It is also possible for electrical current variations in nearby power lines to cause an alarm.

The address codes for these Sensor/Transmitters, as well as the Control Panel/Receivers are pre-set at the factory. However, if a unique address code is needed (e.g. interference from a neighbor's Mier wireless Drive-Alert) you can change the address codes making sure you do so in both the Sensor/Transmitter AND the Control Panel/Receiver so they are different than factory spec, but still match one another. (See page 6 for photos and directions)

The Differences between Mier's three Sensor/Transmitter Choices:

- * DA-610TO Sensor/Transmitter: Both the Sensor and the Transmitter are contained in the same NEMA 4X enclosure. (See photo at the top left) This unit is standard with complete systems.
- * The DA-611TO Remote-Sensor/Transmitter: The Sensor is outside the Transmitter Box, and attached by a 50-foot cable (cable lengths up to 2500 feet are available). This allows the sensor-probe to be buried under or next to the driveway or area to be monitored, and the transmitter box to be hidden up to 50 feet away or placed high above ground for a better range. The sensor should be buried 6 to 12 inches below ground and the cable 3 to 6 inches below ground. Mier HIGHLY RECOMMENDS burying the cable in 1/2-inch PVC pipe to protect it. Try the Sensor and Transmitter locations above ground for a week, before burying the Sensor and cable.
- * The DA-612TO Dual Remote-Sensor/Transmitter: Just like the DA-611TO, but with 2 external sensors.



DA-610TO installation with the Sensor/Transmitter hidden under landscaping next to the driveway.



DA-611TO installation with the Sensor buried under the drive and the Transmitter hidden/mounted on a nearby tree.

Detection-distance from the sensor for a standard-size modern sedan moving 5MPH

	DA-610TO	DA-611TO/DA-612TO
Maximum sensitivity	14 feet	17 feet
Factory set sensitivity	13 feet	16 feet
75% sensitivity	11 feet	14 feet
50% sensitivity	9 feet	12 feet
Minimum sensitivity	7 feet	10 feet

Wireless Drive-Alert Sensor/Transmitter Installation Guide

DA-610TO



DA-611TO



DA-612TO



The Sensor/Probe portion of a DA-610TO, DA-611TO or DA-612TO senses the vehicle and should to be placed less than 3 feet of Zone/area you wish to monitor moving vehicles or assets (the closer the better). The Transmitter portion contains the electronics inside the black box.

The Sensor and Transmitter operates on 2 - AA batteries providing 3.0 volts DC to the electronics. We highly recommend Lithium batteries for longer use and better reliability in cold conditions. Please observe polarity when installing (see next page). Typical battery life is 1-2 years in a residential installation. The Transmitter sends a continuous signal for about 1 minute after the power switch is turned on, and then is ready to act on Sensor inputs. When the battery voltage reaches 2.7 volts, a low battery signal is sent to the Control Panel/Receiver in the home/business and the LO BATT LED on the Control Panel/Receiver will be lit to indicate the batteries should be replaced soon. After installing batteries and confirming operation, the top cover can be put back on the enclosure with careful attention to keeping the gasket in place. DO NOT over-tighten the screws on the cover which would cause the case to crack. DO NOT wipe off the thin layer of silicone oil on the underside of the cover. Failing to do these things will result in moisture entering the enclosure. The Sensor/Transmitter can now be placed in position.

For maximum range, the black box Transmitter portion of the DA-610TO, DA-611TO or DA-612TO should be placed 3 to 4 feet above ground on a post, tree, etc.. The front of the Transmitter Box should also face the Control Panel/Receiver in the home/business for best range. If the black box transmitter is on the ground the range will be 500 feet, but if it's 3 to 4 feet off the ground the range jumps to 1000'.

Make sure the Sensor and Transmitter Box are at least 50 feet from streets or roads, and 40 feet from power lines.

Test the system using a vehicle to pass by the Sensor at 5 to 10 MPH, with a direct line of sight, or by swinging a steel object along the long side of the Sensor. Either should set off the audible alert.

Once testing is successful, choose the final mounting locations and perform vehicle pass or waving metal near the sensor tests repetitively for consistent detection before finalizing installation (and burying any cable if needed).

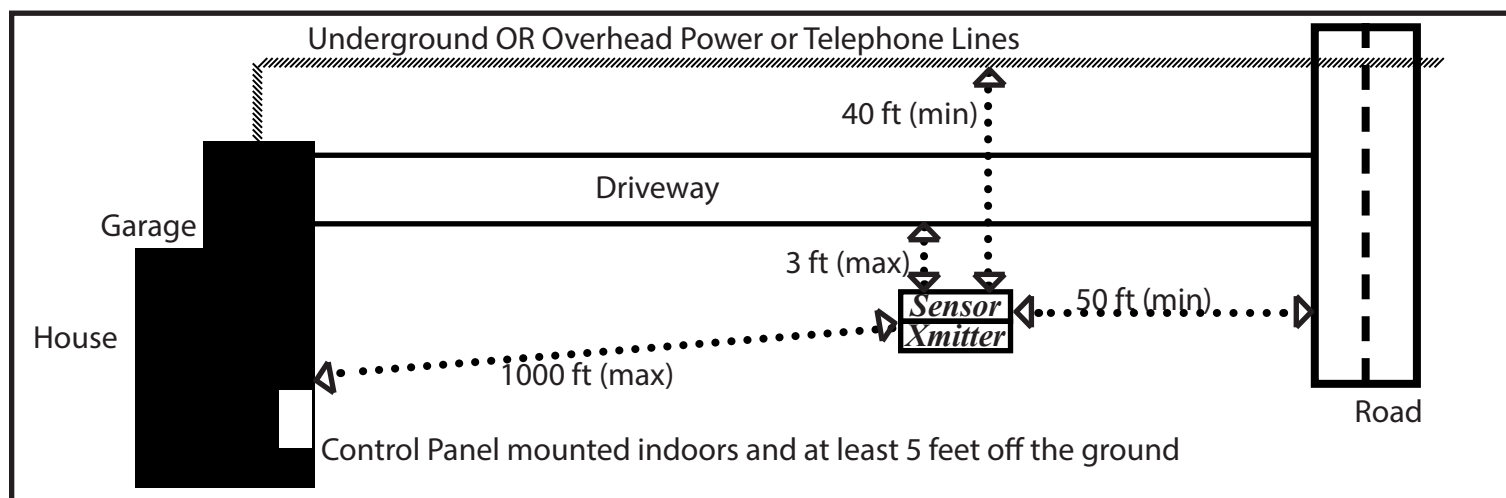

Wireless Drive-Alert Sensor/Transmitter Installation Guide

If occasional false alarms occur, or you are not detecting some vehicles, you can try re-locating the Sensor, or you can reduce the Sensor Sensitivity. There is a small blue sensitivity pot on the electrical board. Maximum sensitivity adjustment is clockwise and minimum is counter-clockwise (note arrow direction). Reducing sensitivity would reduce detection of road traffic, but would also reduce the detection sensitivity in the driveway. See photo ST-A below.

The Transmitter Address Code Switches must be set to match those inside the Control Panel/Receiver. These switches are preset at the factory for code 000 (no jumpers). Only change them if the Control Panel/Receiver code is also changed. Example: of when two neighbors, living right next to each other, both have Drive-Alerts, one neighbor should switch codes so both their Drive-Alerts remain exclusive to their own driveway. See photo ST-B below and CP-B on next page.

The Transmitter Zone Code Switches are preset at the factory for code 000 (no jumpers) for just one Zone/driveway/area to monitor. If more than one Zone is to be monitored, place jumpers on the Zone Pins on the electrical board in the black box to active them, AND pull the jumper off of the JP3 Jumper Pin inside the white DA-700 or DA-100 Control Panel. The Drive-Alert will give a different Chime tone for each Zone monitored. See photo ST-C below and CP-C on the next page.

This photo of the Transmitter board inside the black box shows where to place the batteries, turn it On, see the Valid Transmit light, change the Detection Sensitivity (if needed), change Addressing (if needed), set for Zoning (if needed).

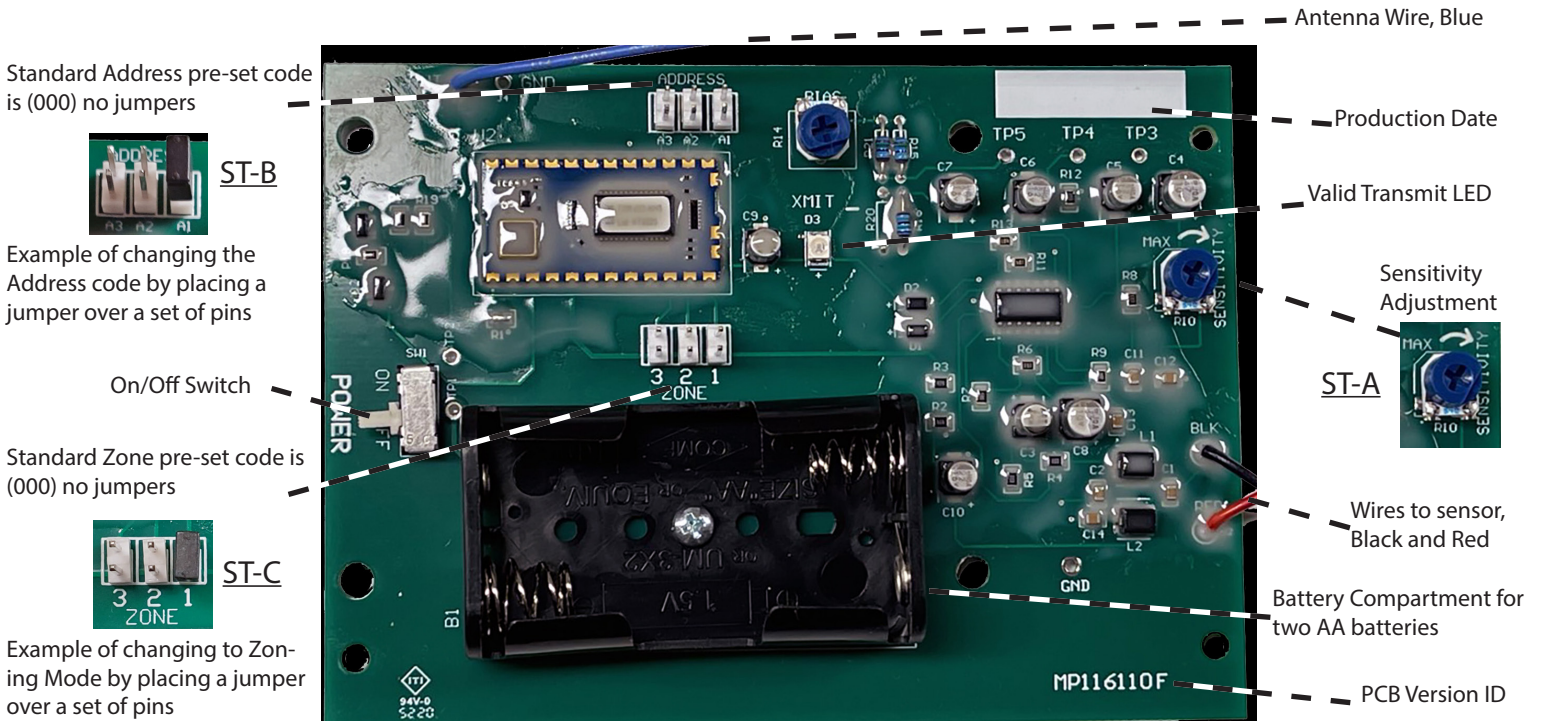

Sensor/Transmitter Installation Examples



At the base of a pole



3-foot high for greater range



Under landscape next to the drive



Under a DA-ROCK1 fake rock next to the drive



DA-611TO transmitter box 4 foot high in a tree for greater range
Note: DO NOT mount a DA-610 on a tree.



DA-700 and DA-700-611 Control Panel Installation Guide



Under the DA-700 Control Panel/Receiver cover you will see the electrical board (shown below).

A Power LED GREEN indicates that the power is on and that the internal solid-state 1 Amp Fuse is okay.

The Control Panel/Receiver Address Code Jumper Ports (A3, A2, A1) must be set to match those in the Sensor/Transmitter. They are factory set with no jumpers. See photo CP-A below. They should only be changed if the Sensor/Transmitter code is also changed. Example: of when two neighbors, living right next to each other, both have Drive-Alerts, one neighbor should switch codes so both their Drive-Alerts remain exclusive to their own driveway. See photo CP-B below and ST-B on the previous page.

Zoning detects up to 3 separate areas and provide different tones for each. You must pull the Jumper off of the JP3 Zone Jumper. See CP-C below. You must also put jumpers on the Zoning Pins in the Sensor/Transmitter See photo ST-C on previous page. The RL1/D8, RL2/D9 and RL3/D10 red LEDs light up when a corresponding Sensor/Transmitter detects activity in that zone.

The Chime Tone Choice Switch allows the owner to choose from three different chimes based on the position of this switch. (CP-D)

The Mute/Delay and Relay Timer Switch (CP-E) allows you to choose which you will program using the green program button next to it. See the next page for instructions on setting the time and activating the Mute/Delay, as well as setting the Relay Timer for accessories.

The RL5/D12 LED, red, is on when the Control Panel/Receiver detects a valid transmission and when the relay is closed.

An orange LED activates if the Mute/Delay internal button or accessory external button is activated.

A Low Sensor Battery Warning LED YELLOW indicates when batteries are low at the Sensor/Transmitter.

NOTE: Sensor Sensitivity Control is in the Transmitter (previous page), and is NOT controlled by this Control Panel.

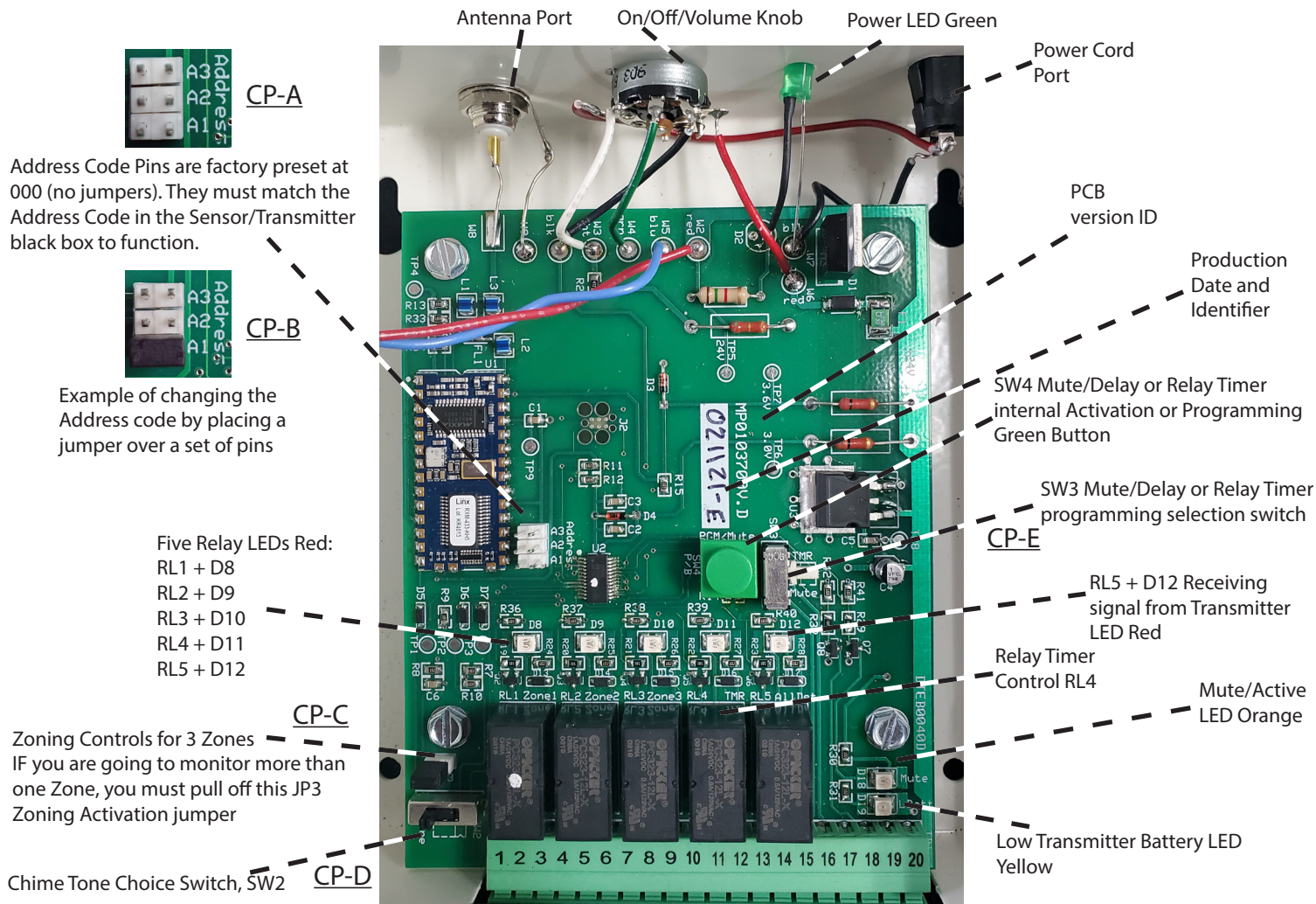

DA-700 Control Panel Programming the Accessory Timer or the Mute/Delay

Both the Mute/Delay and the Accessory Timer are programmed the same way. Both timers are monitored by either relays or logic values.

Both retain their programs if the unit is powered off and on, or if there is a power outage. They can be reprogrammed or erased.

The Mute/Delay can be set for 10, 20, 30 or 60 minutes, and the Accessory Timer can be set for a quick 1.5 seconds or 5, 30 or 60 minutes.

The factory default for both programs is set at 0. Both timers “see the software timing function” detect control bit, but will only activate if there is a value (time) programmed into the timer.

When either timer is activated and then reaches the programmed time period parameter, they will deactivate and automatically reset until they are triggered again. If the timer is active and still within the programmed time, and another alert is detected, they timer will not reset but continue the initial programmed time.

If you wish to reset the timer manually, turn off the power switch of the Control Panel to first deactivate the timer, and then turn it back on to put it back into “ready mode.”

To program the Accessory Timer Relay:

Move the SW3 switch to the Timer position and push the Green Button for 6 seconds as shown here, and release the Green Button as soon as the LED begins to flash.

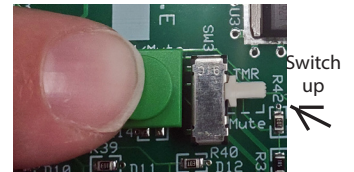

The LED will flash for 6 seconds, and you must set your programming while it’s flashing in this 6-second window.

While it’s flashing, depress the Green Button the number of times corresponding to the amount of Mute/Delay time you desire:

- Depressing the Green Button 1 time will give you a Timer activation of a quick 1.5 seconds
- Depressing the Green Button 2 times will give you a Timer activation of 5 minutes
- Depressing the Green Button 3 times will give you a Timer activation of 30 minutes
- Depressing the Green Button 4 times will give you a Timer activation of 1 hour
- After the LED stops flashing, if you have depressed the Green Button 1, 2, 3 or 4 times, your program is set.
- Move the SW3 switch back to the Mute position to keep both the Timer and the Mute in “ready mode” so they can be activated
- To test, push the Green Button and the Timer LED should stay on for the time-period selected

to program the timer period for Mute/Delay:

Move the SW3 switch to the Mute/Delay position and push the Green Button for 6 seconds as shown here, and release the Green Button as soon as the LED begins to flash.



The LED will flash for 6 seconds, and you must set your programming while it’s flashing in this 6-second window.

While it’s flashing, depress the Green Button the number of times corresponding to the amount of Mute/Delay time you desire:

- Depressing the Green Button 1 time will give you a Mute/Delay of 10 minutes whenever the button is pushed again
- Depressing the Green Button 2 times will give you a Mute/Delay of 20 minutes whenever the button is pushed again
- Depressing the Green Button 3 times will give you a Mute/Delay of 30 minutes whenever the button is pushed again
- Depressing the Green Button 4 times will give you a Mute/Delay of 1 hour whenever the button is pushed again
- After the LED stops flashing, if you have depressed the Green Button 1, 2, 3 or 4 times, your program is set.
- Keep the SW3 switch in the Mute which will keep both the Mute and the Timer in “ready mode” so they can be activated
- To test, push the Green Button and the Mute LED should stay on for the time-period selected

To program the either the Mute/Delay or the Timer back to the default 0 setting:

- Move the SW3 switch to either the Mute/Delay or the Timer position depending on which you want to set back to 0
- Depress the Green Button for 6 seconds until it starts flashing
- Release the Green Button as soon as it starts flashing, and then do not touch it again
- Once it stops flashing, after approximately 6 seconds, it will be set back to the factory default time setting of 0

DA-700 Control Panel Terminals

The terminal block provides convenient wire connection for external device control and tests. All contacts are dry, rated low voltage/low current, so DO NOT APPLY 120VAC to any of these contacts.

Attach your wiring to the terminal block and push it up into the terminal block receptacle of the DA-700.

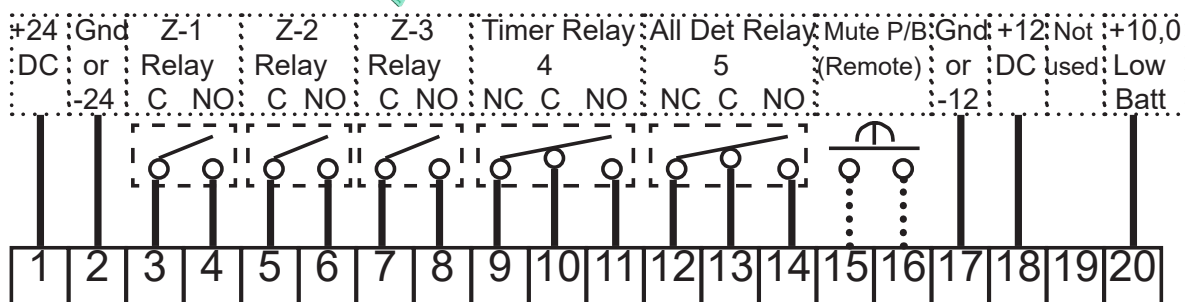
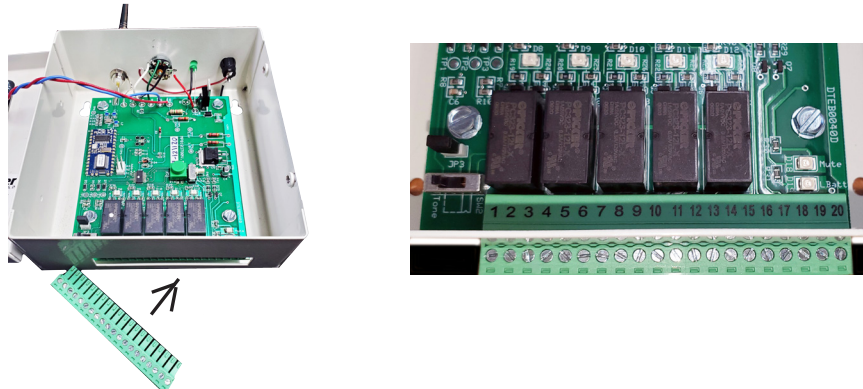

- 1 = +24DC +24VDC Power Source to Operate Accessories
- 2 = Gnd Ground or -24VDC or -12VDC

- 3 = Zone 1 Common for Zone 1 Relay (RL-1 LED)
- 4 = Zone 1 Normally Open Contact for Zone 1

- 5 = Zone 2 Common for Zone 2 Relay (RL-2 LED)
- 6 = Zone 2 Normally Open Contact for Zone 2

- 7 = Zone 3 Common for Zone 3 Relay (RL-3 LED)
- 8 = Zone 3 Normally Open Contact for Zone 3

- 9 = Timer Relay Normally Closed Contact for Timer Relay (RL-4 LED)
- 10 = Timer Relay Common for Timer
- 11 = Timer Relay Normally Open Contact for Timer Relay

- 12 = All Detect Relay Normally Closed Contact for All-Detection Relay (RL-5 LED)
- 13 = All Detect Relay Common for All Detection Relay
- 14 = All Detect Relay Normally Open Contact for All-Detection Relay

- 15 = Mute/Delay Accessory Switch Input for Mute/Delay Control if green internal Mute/Delay button is not convenient
- 16 = Mute/Delay Accessory Switch Input for Mute/Delay Control if green internal Mute/Delay button is not convenient

- 17 = Gnd Ground or -24VDC or -12VDC
- 18 = +12DC +12VDC Power Source to Operate Accessories
- 19 = Not Used Terminal not currently assigned/used
- 20 = Low Battery Logic Levels: +10 Volts means the Battery is okay, 0 Volts means the Battery is low and the D19 LED is on

If using Zoning (JP3 Pin is pulled off and 2 or 3 sensor/transmitters are used)

- Zone 1 Chime = Ding Dong
- Zone 2 Chime = Ding Ding Ding
- Zone 3 Chime = Dong Ding Dong

The Timer Relay for lights and other devices can be set for a quick 1.5 seconds, or for 5, 30 or 60 minutes.

Mute can be set for 10, 20, 30 or 60 minutes

NOTE: If any relay operates (the relay's LED is on) the contacts between the Common and Normallly Open will CLOSE.
If the relay operates (the relay's LED is on) the contacts between the Normally Closed and Common will OPEN (ex: RL4, 9&10)

DA-700 Control Panel Hooking Up Other Equipment

Connecting a DA-066MP Wireless Chime Transmitter, for DA-078 Chimes, to a DA-700 Control Panel

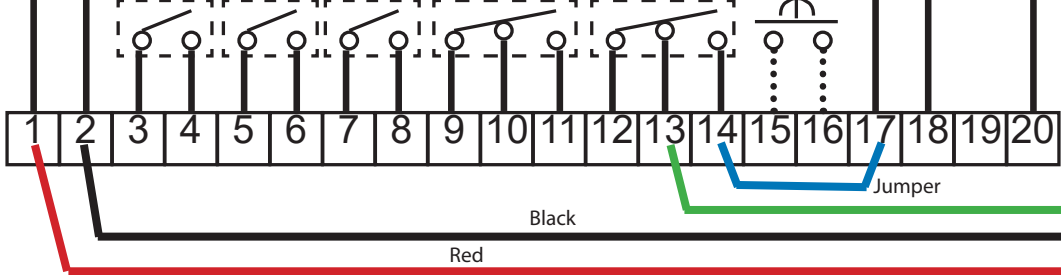
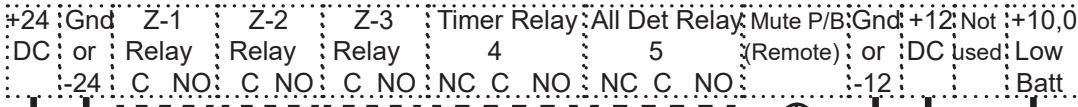

DA-066MP Wireless Chime Transmitter (up to 100 ft)



Red wire from DA-066MP to #1 terminal/+24DC. Black wire from DA-066MP to #2 terminal/GND. Green wire from DA-066MP to #13 terminal/All Detect "C" Common. Jumper wire from terminal #14/All Detect "NO" Normally Open to #17 terminal/GND.

Connecting a DA-REPEATER Wireless Alert Transmitter, for DA-100 and other Control Panels, to a DA-700 Control Panel

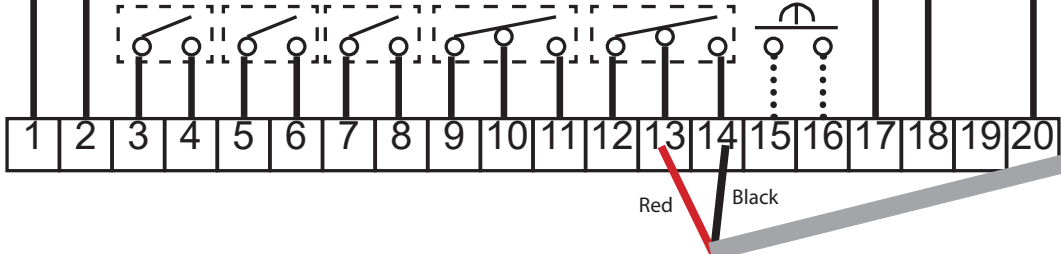
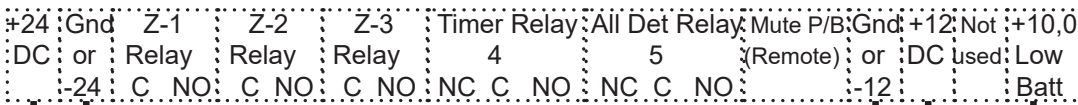

DA-REPEATER Wireless Transmitter (up to 1000 ft)



Red wire from inside the gray DA-REPEATER cable to #13 terminal/All Detect "C" Common. Black wire from inside the gray DA-REPEATER cable to #14 terminal/All Detect "NO" Normally Open.

Connecting a Hard Wired DA-655 Chime to a DA-700 Control Panel

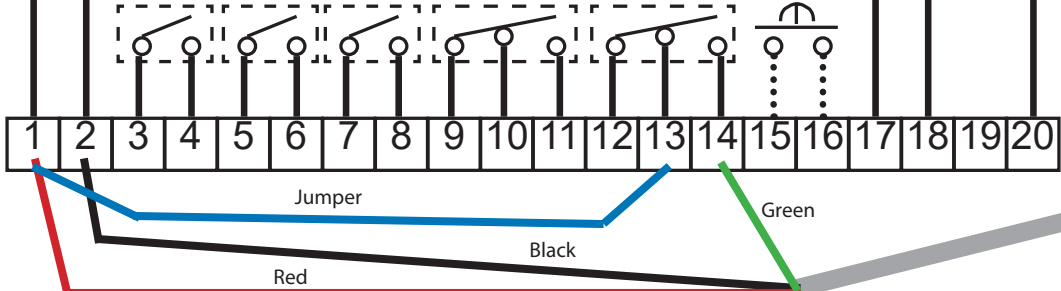
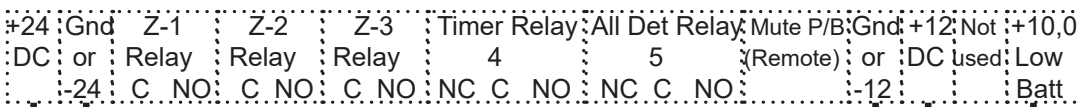

DA-655 Hard-Wired Chime with volume control



Red wire from DA-655 to #1 terminal/+24DC. Black wire from DA-655 to #2 terminal/GND. Green wire from DA655 to #14 terminal/All Detect "NO" Normally Open. Jumper wire from terminal #1/+24DC to #13 terminal/All Detect "C" Common.

DA-700 Control Panel Hooking Up Other Equipment Continued

Connecting Wireless Transmitters, such as Mier's DA-606 Wireless Transmitter Control for lights to a DA-700 Control Panel

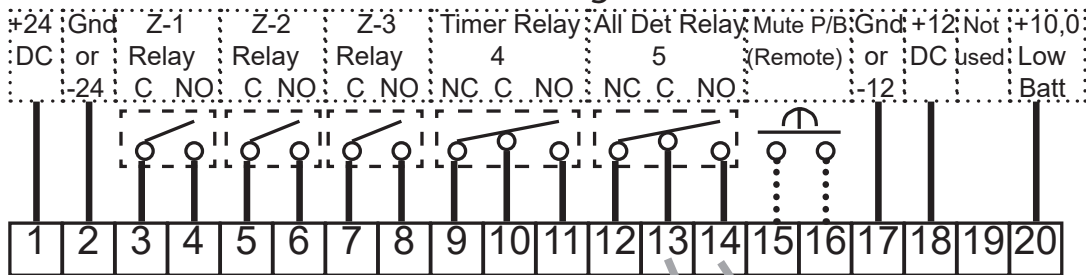

DA-606LK Wireless Transmitter Control for Light Kits



Two Gray wires from the DA-606LK wireless light transmitter: one goes to #13 terminal/All Detect "C" Common, and the other goes to terminal #14/All Detect "NO" Normally Open.

Connection for Hard-Wired Lights to a DA-700 Control Panel

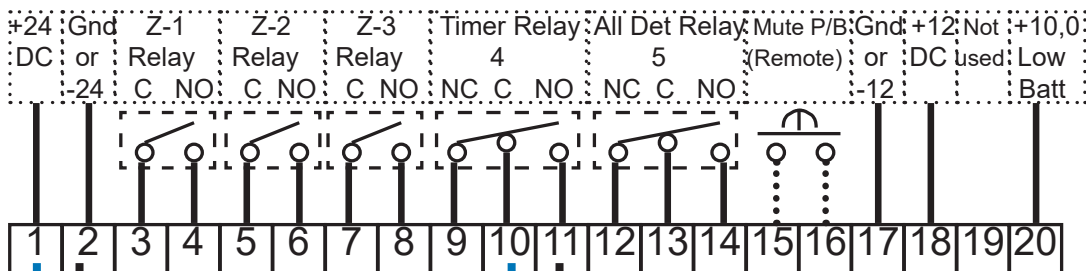

MAX 10 AMP CIRCUIT

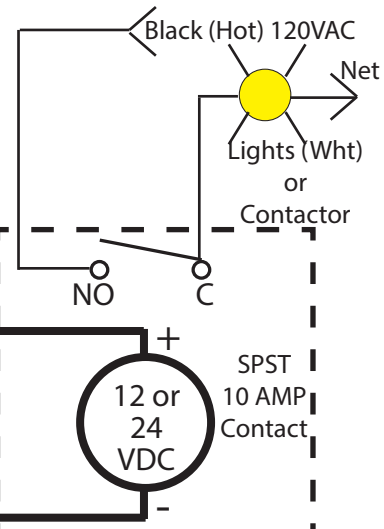

Jumper from #1 to #10 for +24VDC
OR
Jumper from #18 to #10 for +12VDC

Relay circuit provided by customer

Jumper wire from #1 terminal/+24V OR #18 terminal/+12 to #10 terminal/Timer Relay "C" Common.
Wire from terminal #11/Timer Relay "NO" Normally Open to +12VDC or +24VDC MAX 10 Amp Circuit Contact.
Wire from terminal #2 or #17/Ground to -12VDC or 124VDC Max 10 Amp Circuit Contact.

NOTE: The DA-052 Remote Whistle hooks up this way too.

Connecting a DA-700 Control Panel to a DA-505 or DA-505W Timer Control Unit

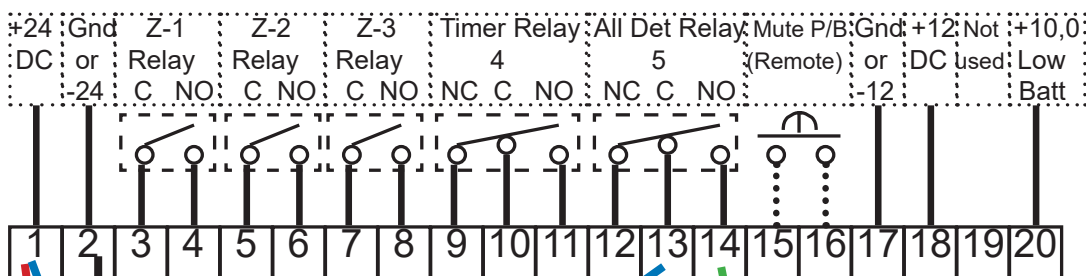

DA-505 DA-505W

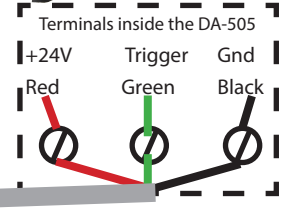

Red wire from DA-505(w) to #1 terminal/+24DC. Black wire from DA-505(w) to #2 terminal/GND. Green wire from DA-505(w) to #14 terminal/All Detect "NO" Normally Open. Jumper wire from terminal #13/All Detect "C" Common to #1 terminal/+24DC.

Accessories

WIRELESS DRIVE-ALERT ACCESSORIES:



DA-066MP DA-078 DA-100CP DA-REPEATER DA-606 DA-071 DA-072 DA-073 DA-ROCK1

- The DA-066MP Remote Chime Transmitter is used in combination with the wireless DA-078 Remote Plug-in Chime(s) in applications where more chimes are wanted in more rooms/areas. Unlimited quantities may be used.
- The DA-100CP Long Distance Remote Chime is actually a self-contained Control Panel/Receiver that receives a signal from up to 1000 feet of any of Mier's wireless Sensor/Transmitters, or a DA-REPEATER, and provides a pleasant tone as an alert. It also includes volume control.
- The DA-REPEATER can be attached to a DA-700 or DA-500 Control Panel/Receiver and repeats the signal to other wireless Control Panel/Receivers (DA-100CP, DA-700CP) up to 1000 feet away, or up to 3/4-mile with the use of a DA-660 Antenna (see previous page).
- The DA-606LK Wireless Light Kit comes with a DA-606 Timer Control, one DA-071 Light-Switch, and one DA-072 Lamp Module. Any number and combination of light-switches and lamp modules may be used. For heavy-duty applications the DA-073 Heavy-Duty Outlet includes a top receptacle that handles up to a maximum of 1800 watts or maximum of 15 amps.
- The DA-ROCK1 is a popular accessory with all of our wireless systems, and is used to hide the DA-610 Sensor

HARD-WIRED DRIVE-ALERT ACCESSORIES:

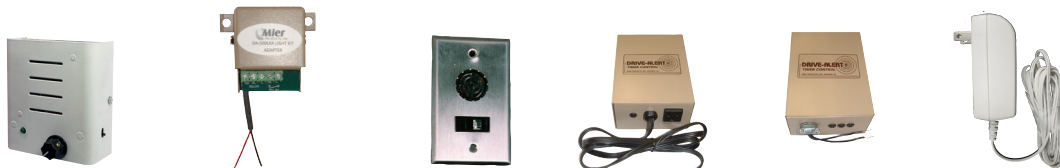

DA-655 DA-500LKA DA-052V DA-505 DA-505W DA-050

- The Hard-Wired DA-655 Chime with Volume Control is our most popular accessory for the model DA-500 Drive-Alert in Drive-up Window or business applications!
- The DA-500LKA is a set of Form C Dry Contacts that can be attached to the DA-700 or DA-500 Control Panels.
- The DA-052V Whistle with Volume Control – is used with the DA-700 when a second whistle is desired (hard-wired installation)
- The Hard-Wired DA-505 Timer Control will turn on 10 amps of lights, sirens or bells from 1-45 minutes. The DA-505 unit simply plugs into a 120 VAC outlet and contains its own receptacle to provide power to lights or alarms.
- The Hard-Wired DA-505 Timer Control will turn on lights, sirens or bells from 1-45 minutes. The DA-505W is a "stand alone" unit that gets its power from the Drive-Alert, and provides a N.O., timed, dry contact to switch a load (lights, contactors, bells, etc) rated at 10 amps, 120 volts AC. The DA-505W is a terrific intermediate interface with a "healthy" large relay within, that may be used to control other functions such as triggering a large commercial lighting contactor, billboards, holiday lights, etc.
- The DA-050 Power Pack is a replacement power-pack/transformer for the Drive-Alerts.

If your Drive-Alert accessories do not look like these, you may have older models. Please call Mier's free tech support line at 800-473-0213

Four Options for Long Range Drive-Alert Installations



The DA-660 Reception Booster Antenna is perfect when monitoring remote buildings or equipment:

This antenna is used to increase the standard reception distance of 1000-feet, to up to 3/4-mile from the Sensor/Transmitter to the Control Panel/Receiver. Simply unscrew the standard antenna on the DA-700 Control Panel or DA-100 Control Panel and 75ohm coaxial cable, RG6, to the F Connectors on the Control Panel and the DA-660 Reception Booster Antenna.

- * 34" Long, 13" Wide, 1" High and weighs approximately 1 pound
- * Frequency = 433.92 mHz
- * Impedance = 75 Ohms
- * Gain = 10.6 dB
- * Type = 7 Element Yagi

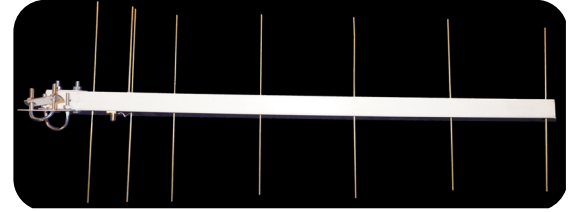

The DA-611TO and DA-612TO Sensor/Transmitters increase transmission distance:

The Sensor(s) is/are outside the Transmitter Box, and attached to the Transmitter by a 50-foot cable (cable lengths up to 1000 feet are available). This allows the sensor to be buried under or next to the driveway or area to be monitored, and the transmitter box to be hidden up to 50 feet away and 4 feet above ground for an increased transmitting range. The sensor should be buried 6-12 inches below ground and the cable 6 inches below ground. Mier HIGHLY RECOMMENDS burying the cable in 1/2-inch PVC pipe to protect it. Try the Sensor and Transmitter above ground for a week, before burying the Sensor, to assure conditions and product operate satisfactorily. Note: installation instructions come with these Sensor/Transmitters when ordered, or are available for download on our website.

DA-611TO



DA-612TO



The DA-REPEATER is perfect for providing additional alerts in remote buildings

This Drive-Alert Signal Repeater can be attached to any DA-700 or DA-500 Drive-Alert Control Panel/Receiver. It will repeat the alert signal to other wireless Control Panel/Receivers (DA-100CP, DA-700CP), up to an additional 1000 feet away, or another 3/4-mile if DA-660s are used with them. If a site has multiple buildings and/or locations where an alert is desired, add a DA-REPEATER to a DA-700 Control Panel/Receiver, and then add DA-100CP Chimes with Volume Control (shown below) in those other buildings.



The DA-100CP Long Distance Remote Chime for adding chimes to remote buildings:

The DA-100CP is actually a self-contained Control Panel/Receiver on its own, and receives a signal from up to 1000-feet of any of Mier's wireless Sensor/Transmitters, OR a DA-REPEATER (shown above), and provides a pleasant tone as an alert. It also includes volume control.

Please contact our Tech Support Team and we will be happy to "Google™earth" your installation site, and provide you with information on the products needed, and locations for each piece to meet your installation/application goals. Don't forget to check out our website for cut-sheets, installation manuals, installation examples, and information on more products!

Supplemental Specifications

DA-700 CONTROL PANEL/RECEIVER:

1. Weight: 2.2 pounds with antenna attached
2. Dimensions: 5.5" H x 6.0" L x 2.0" D
3. Operating Temp Range: a low of 0 degrees F, up to a high of 105 degrees F
4. Input Power Supply: UL Listed 120VAC/208 50/60HZ
5. Power Output: 24VDC at 500MA, 5% Reg, Overload Protection
6. Receiver Power Required: Minimum of 150MA, Maximum 225MA
7. Frequency: 433.92 MZ
8. Antenna: 1/4 Wave Monopole, extendable
9. Receiver/Decoder: Linx Module KH3
10. Addressable Receiver: Jumper Select (3 positions)
11. LED Indicators: RL1 - RL5, Power, Mute, Low Battery
12. Onboard Power Supplies: +3.0VDC, 3.6VDC, 12VDC and 24VDC
13. Internal Fuse: F1 solid state device, non user replaceable, automatic reset
14. Onboard Microprocessor: Generate chime tones, control logic and output interface
15. 2 Programmable Timers: Controlled by microprocessor. Mute Timer silences the chime alert(s) for a programmed period of time of 10, 20, 30 or 60 min. Utility Timer for accessories, such as lights, with programmable times of 1.5 seconds or 5, 30 and 60 min. Both timers have relay outputs active for the programmed time period.
16. Relay and Logic Outputs; All functions have relay and logic outputs via TB1, 20 terminals, to interface all devices, ie security systems or automation systems
17. TB1 Terminal Strip; Provides +24VDC and +12VDC for optional accessories with relay control
18. Manual Select Tone Control Jumper JP3 for single area control mode

DA-610TO Sensor/Transmitter:

1. Power Requirements: Two (2) AA Batteries 3.0 VOLTS DC - Lithium Recommended
2. Operating Frequency: 433.92 MHZ Fixed
3. Antenna: 6.5" Wire inside outdoor rated transmitter box
4. Transmitter Output: 2 Milliwatts
5. Transmitter: Linx Technologies Model KH Encoder/Transmitter
6. Encoder Modulation: Amplitude ON-OFF Keying (OOK) at 1200 BPS.
7. Address Codes: Jumper Plugs elected for the encoder (3 positions)
8. Data: One Data BIT encoded when battery is low
9. Transmitter ON time: Less than 5 seconds for any single alarm
10. Enclosure: Outdoor, NEMA 4X, Non-Metallic, Weather Sealed enclosure houses the Transmitter
11. Quiescent Current : 60 Microamp
12. Active Current: 3 Milliamp
13. Battery Life: One Year in residential installation, but up to 5 years if using lithium batteries
14. Operating Temperature: -40 DEGREES F TO + 125 DEGREES F
15. Weight: 3 Pounds
16. Detection of Vehicles: Distance from Sensor/Transmitter for a standard sedan moving at 5mph+ is 14 feet max, 9 feet min, 7 feet, min

DA-611TO Sensor/Transmitter:

ALL SPECIFICATIONS ARE THE SAME AS THOSE LISTED FOR THE DA-610TO ABOVE, EXCEPT THE FOLLOWING:

- A. The sensor is not inside the transmitter enclosure; it is an external sensor attached to the transmitter enclosure with 50' of cable (see sensor options page)
- B. Detection of Vehicles: Distance from Sensor for a standard sedan moving at 5mph+ is 17 feet max, 12 feet min, 10 feet min

FCC ID: SGXMPIDA066

This device complies with Part 15 of the FCC Rules and Industry Canada license-exempt RSS standard(s). Operation is subject to the following two conditions:

- (1) This device may not cause harmful interference
 - (2) This device must accept any interference received, including interference that may cause undesired operation.
- Any changes not expressly authorized by Mier Products, Inc. may void the user's authority to operate this equipment.

IC ID: 5583ADA-066MP

Cet appareil est conforme a des reglements d'industrie Canada exempts de license standard RSS (s). Son fonctionnement est soumis aux deux conditions:

- (1) Ce dispositif ne doit pas causer d'interferences nuisibles
- (2) Cel appareil doit accepter toute interference recue, y compris les interferences pouvant entrainer un fonctionnement indesirable.

DA-066MP Wireless Chime Transmitter (optional accessory):

The DA-066MP Remote Chime Transmitter is attached to a DA-700 Control Panel and is an option on the DA-500. It is a 315 Mhz transmitter with ASK/OOK encoded signal. It is activated by a relay closure on a Drive-Alert, or by pushing the button on the case. It requires 15-30 volts DC on the RED and BLACK wires. The WHITE wire when pulled to ground will activate the transmitter.

- Frequency: 315 Mhz Crystal Controlled
 Power: .002 WATTS
 Power Input: 15-30 Volts DC at .025 AMPS
 Weight: 9 Ounces
 Antenna: 1/8 Wave Quasi-Loop, -2 DBI Gain
 Duty Cycle: 50% Encoder Duty Cycle at 1 Mhz
 On Time: Normally 1 Second of Transmit Time



DA-700 and DA-700-611 Troubleshooting

- Check to make sure the Power Light is on. If not, unplug and wait 5 minutes, then power up again to see if the internal solid-state 1A fuse cleared the fault and reset. If not, and the power light still does not come on, send to Mier Products for repair.
- To test the low battery function it is necessary to install batteries that equal 2.5 volts or lower into the black outdoor Sensor/Transmitter box to activate the word data bit to be detected by the white indoor Control Panel
- DO NOT mount the Control Panel/Receiver within 10 feet of a wireless modem, cell phone, or cordless phone
- DO NOT put the Control Panel/Receiver in a basement unless using a DA-660 Reception Booster Antenna
- DO NOT mount the Control Panel/Receiver outdoors
- DO NOT mount the Control Panel/Receiver within 12 inches of Aluminum or Steel electrical enclosures
- Make sure the Control Panel is mounted above-ground where its antenna can receive a signal from the Sensor/Transmitter, and make sure the Sensor/Transmitter is in a position with clear line of sight where it can send a signal freely. Make sure there are no trees, large metal objects, mirrors, aluminum siding, etc. between the Control Panel and the Sensor/Transmitter, as they will cause interference. In these cases, use a DA-660 Reception Booster Antenna mounted in an area where it receives a direct signal.
- Mount the Sensor parallel to the driveway whenever possible
- DO NOT mount the Sensor more than 3 feet from the edge of the driveway or area to be monitored
- DO NOT mount the Sensor more than 4 feet above ground: this is above the non-ferrous belt-line
- Mount the Sensor securely: IT MUST BE STABLE AND MOTIONLESS! Any movement of the sensor will cause an alarm. Don't mount the Sensor on a tree, post or gate that might move in the wind.
- DO NOT mount the Sensor where it might be near underground or above ground power lines. Power surges in the sensor area will cause false alarms.
- DO NOT bury the Transmitter Box in the ground.
- DO NOT install the Transmitter Box in an Aluminum, Copper or Steel enclosure which will result in shielding
- Make sure address codes inside the Control Panel match the address codes in the Sensor/Transmitter Box
- If you must mount the Control Panel/Receiver inside a Stucco wall, or aluminum sided wall, or in a basement use a DA-660 Reception Booster Antenna which can be mounted outside the wall
- For long-range applications, consider a DA-660 Reception Booster Antenna which can be mounted in an attic for additional range (note: metal roofs will interfere with the signal, but wood/shingle is fine) and/or using a DA-611TO or DA-REPEATER (see long range options page for more details)
- If there are hills in the terrain between the Transmitter Box and Control Panel/Receiver, you may need to use a DA-611TO or DA-612TO Sensor/Transmitter and/or a DA-660 Reception Booster Antenna
- E-Glass windows in the path of the line-of-sight between the Transmitter and Control Panel/Receiver will cause interference. In these installations, move the Control Panel/Receiver away from the window, or consider using a DA-660 Reception Booster Antenna.
- If installing a DA-066MP, make sure the address codes in the DA-066MP match those in the DA-078 Chimes

DA-700 and DA-700-611 Troubleshooting continued

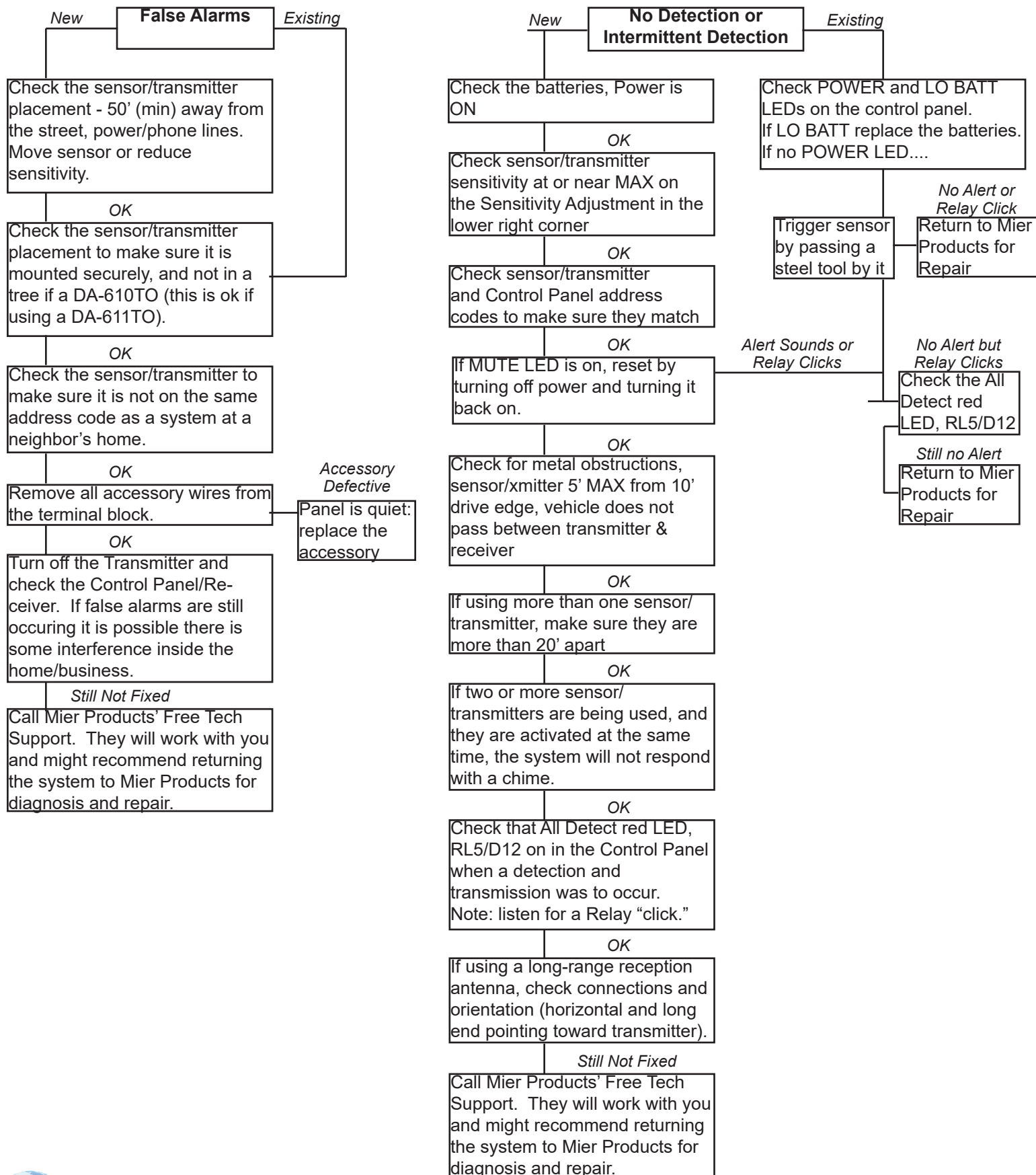

Mier Products' Drive-Alert Technical Support

Mier Products, Inc. provides free telephone and email lifetime technical support for all of our Drive-Alert vehicle detection systems. Call us between the hours of 8:00 am and 5:00 pm EST, send an email, or download our Cut-Sheets, Instruction Manuals, or FAQs from our website. 800-473-0213 ~ info@mierproducts.com ~ www.mierproducts.com

Mier Products' Drive-Alert Warranty

Limited Warranty for Drive-Alert Models and Accessories Manufactured by Mier Products, Inc.

Mier Products, Inc.'s Limited Warranty Program for Drive-Alert Series of Vehicle Detection Systems and Drive-Alert Accessories protects the original owner for one year from the date of purchase against defects in original parts or workmanship. Mier Products, Inc. agrees to repair or replace parts (Mier's option) that are deemed defective by our Quality Control Team, without charge for parts or labor, if the defective unit is returned prepaid to Mier Products, Inc., Kokomo, IN, within the one-year period.

Close inspection and testing, at the time of receipt by the customer, will quickly determine product quality. Thus, Mier Products, Inc. recommends inspection of, and testing, the Drive-Alert models, direct burial cable, and accessories immediately upon receipt, before installation or driving to an installation site, and contacting Mier Products, Inc. if quality issues arise.

NOTE: Sensors and cables that have been buried are not covered. Wireless sensors that have been sitting in flooded areas or standing water are not covered.

Mier Products, Inc. does not assume responsibility for claims or damages caused by improper installation or use of these products, accessories, and/or products connected to or stored within them. Mier Products, Inc. does not assume responsibility for damages to these products or their accessories due to shipping damage or damage occurring while in a customer's warehouse and/or possession. Mier Products, Inc. does not assume responsibility for damage due to accident, faulty wiring, overload of Drive-Alert System or Drive-Alert accessory output, or components attached to the Drive-Alert parts. Drive-Alert models and accessories must be shipped, handled, stored, and installed with strict adherence to OEM installation instructions.

Drive-Alert accessories and parts built by other OEMs (including but not limited to chimes, lamp modules, light switches, bells, splice kits) are covered under their respective OEM warranties.

This warranty constitutes the entire warranty with respect to Mier's Drive-Alert Models and Accessories and IS IN LIEU OF ALL OTHERS, EXPRESSED OR IMPLIED, INCLUDING ANY WARRANTY OR MERCHANTABILITY AND WARRANTY OF FITNESS FOR A PARTICULAR PURPOSE AND IN NO EVENT IS MIER PRODUCTS, INC., OR IT'S DISTRIBUTOR, DEALER, OR OEM PARTNERS, RESPONSIBLE FOR ANY CONSEQUENTIAL DAMAGES OF ANY NATURE WHATSOEVER.

Any warranty OR sales questions should be directed to Mier Products at 800-473-0213, or via e-mail to info@mierproducts.com

Any repair work not covered by this Warranty is available for a nominal charge.

Products which customers wish to return for reasons other than Warranty must first call Mier Products, Inc. to receive a Return Material Authorization Number (RMA#). Returns are subject to a 15%-20% re-stocking fee as well as return shipping. NOTE: Special Order products, such as Mier's Temperature Controlled Enclosure line, are non-cancellable and non-returnable.



Wireless Vehicle Detection | Buried Sensor Systems | Driveway Alarms | Drive-Up Window Detection | Instrument Boxes | DVR & CPU Lockboxes | Flush-Mount Cabinets | NEMA Outdoor Enclosures | NEMA Temperature Controlled Enclosures | NEMA Rack Enclosures | Rack Shelves and Drawers | NEMA Non-Metallic Enclosures | Power Supply Boxes | Siren/Speaker Cabinets | Bell Boxes | Battery Cabinets | Transformer Enclosures | Custom Enclosures and Fabrication | Custom Graphic Screening and Colors

800-473-0213 ~ info@mierproducts.com ~ www.mierproducts.com

NOTES

Date of Drive-Alert Installation: _____

Name of Installer and Installation Company: _____

Phone number and email of Installer/Company: _____

Mier Product's Drive-Alert Equipment Installed and Part Numbers: _____

Name/Contact Information of where the Mier Products' Drive-Alert Equipment was purchased if different than Installation Company:

Other manufacturer's and Accessories/Equipment Installed and Part Numbers: _____

Name/Contact Information of where the other Equipment was purchased if different than Installation Company above:

NOTES

