

ALTV248 Series

8-Output CCTV Power Supplies

Models Include:

ALTV248

- 24VAC @ 4A (100VA) or 28VAC @ 3.5A (100VA).
- Eight (8) Fuse Protected Outputs.

ALTV248175

- 24VAC @ 7.25A (175VA) or 28VAC @ 6.25A (175VA).
- Eight (8) Fuse Protected Outputs.

ALTV248300

- 24VAC @ 14A (350VA) or 28VAC @ 12.5A (350VA).
- Eight (8) Fuse Protected Outputs.

ALTV248600

- 24VAC @ 28A (700VA) or 28VAC @ 25A (700VA).
- Eight (8) Fuse Protected Outputs.

ALTV248CB

- 24VAC @ 4A (100VA) or 28VAC @ 3.5A (100VA).
- Eight (8) PTC Protected Outputs.

ALTV248175CB

- 24VAC @ 7.25A (175VA) or 28VAC @ 6.25A (175VA).
- Eight (8) PTC Protected Outputs.

ALTV248300CB

- 24VAC @ 14A (350VA) or 28VAC @ 12.5A (350VA).
- Eight (8) PTC Protected Outputs.

ALTV248600CB

- 24VAC @ 28A (700VA) or 28VAC @ 25A (700VA).
- Eight (8) PTC Protected Outputs.

Installation Guide



Rev. 070612



More than just power.™

Installing Company: _____ Service Rep. Name: _____

Address: _____ Phone #: _____

Overview:

Altronix ALTV248 Series CCTV Power Supplies provide 24VAC or 28VAC distributed via eight (8) fuse or PTC protected outputs for powering CCTV cameras, heaters and other video accessories.

Eight (8) Output ALTV248 Reference Chart:

Altronix Model Number	Output Voltage	Total Output Current (Power)	Number of Outputs	PTC Protected Auto-Resettable Outputs	Fuse Protected Outputs	Output Current (max per output)	Main Fuse Ratings	115VAC 50/60Hz Input Current
ALTV248	24VAC	4A	8	-	✓	3.5A	5A/ 250V	0.9A
	28VAC	3.5A		✓	-	2.5A		
ALTV248CB	24VAC	4A		-	✓	3.5A	10A/ 250V	1.45A
	28VAC	3.5A		✓	-	2.5A		
ALTV248175	24VAC	7.25A		-	✓	3.5A	15A/ 32V	2.7A
	28VAC	6.25A		✓	-	2.5A		
ALTV248175CB	24VAC	7.25A		-	✓	3.5A	Two (2) 15A/ 32V	5.4A
	28VAC	6.25A		✓	-	2.5A		
ALTV248300	24VAC	14A		-	✓	3.5A	Two (2) 15A/ 32V	5.4A
	28VAC	12.5A		✓	-	2.5A		
ALTV248300CB	24VAC	14A		-	✓	3.5A	Two (2) 15A/ 32V	5.4A
	28VAC	12.5A		✓	-	2.5A		
ALTV248600	24VAC	28A		-	✓	3.5A	Two (2) 15A/ 32V	5.4A
	28VAC	25A		✓	-	2.5A		
ALTV248600CB	24VAC	28A		-	✓	3.5A	Two (2) 15A/ 32V	5.4A
	28VAC	25A		✓	-	2.5A		

Specifications:

Input:

- 115VAC, 50/60Hz.

Output:

- Eight (8) fuse or PTC protected outputs.
- 24VAC or 28VAC supply current.
- Outputs are rated @ 3.5A (fused) or 2.5A (PTC).
- Surge suppression.

Features:

- AC power LED.
- Power ON/OFF switch.
- Spare fuses provided.
(all models w/primary and/or secondary fuses).

Enclosure Dimensions:

- **ALTV248, ALTV248CB, ALTV248175 and ALTV248175CB:**
8.5" x 7.5" x 3.5"
(215.9mm x 190.5mm x 88.9mm).
- **ALTV248300 and ALTV248300CB:**
12.25" x 7.25" x 4.5"
(311.2mm x 184.2mm x 114.3mm).
- **ALTV248600 and ALTV248600CB:**
13.5" x 13" x 3.25"
(342.9mm x 330.2mm x 82.6mm).

Installation Instructions:

1. Mount unit in the desired location. Mark and predrill holes in the wall to line up with the top two keyholes in the enclosure. Install two upper fasteners and screws in the wall with the screw heads protruding. Place the enclosure's upper keyholes over the two upper screws, level and secure. Mark the position of the lower two holes. Remove the enclosure. Drill the lower holes and install three fasteners. Place the enclosure's upper keyholes over the two upper screws. Install the two lower screws and make sure to tighten all screws (*Enclosure Dimensions, pg. 8-10*). Secure enclosure to earth ground.
2. Slide switch on PD board to the OFF position for models ALTV248 and ALTV248CB (*Fig. 1, pg. 4*). Turn OFF main switch on all other models, (*Figs. 2-4 pgs. 5-7*).
3. All units are factory set for 24VAC operation.
For 28VAC operation adjust unit prior to mounting and applying power as follows:
Change the wire position so that the black wire [28V] is connected to the terminal marked [P] and the yellow wire [24V] is connected to the terminal marked [S].
4. Connect AC power to the black and white flying lead of the transformer(s) (*Figs. 1-4, pgs. 4-7*). Use 18 AWG or larger for all power connections.
5. Measure output voltage before connecting devices. This helps avoiding potential damage.
Terminals marked [1P - 8P] are positive of the same polarity.
CAUTION: Determine the maximum operating voltage of the equipment being powered before adjusting the output voltage.
6. Connect devices to the terminals marked [1P - 1N] through [4P - 4N] on PD4/PD4CB board (*Fig. 4, pg. 7*) or terminals marked [1P - 1N] through [8P - 8N] on PD8/PD8CB board (*Figs. 1-3, pgs. 4-6*), carefully observing polarity.
7. Slide switch on PD board to the ON position for models ALTV248 and ALTV248CB (*Fig. 1, pg. 4*). Turn main switch on all other models to the "RESET" (ON) position (*Figs. 2-4, pgs. 5-7*).
8. Green LED will illuminate when unit is powered.
9. Upon completion of wiring, secure enclosure door with screws (supplied).

**Caution: Equipment to be installed / serviced by authorized / trained personnel only.
Shut branch circuit power before installing / servicing equipment.**

**WARNING: To reduce the risk of fire or electric shock, do not expose the unit to rain or moisture.
This installation should be made by qualified service personnel and should conform to the National Electrical Code and all local codes.**

Terminal Identification:

PD4/PD4CB - Distribution Module

1P - 4P	AC output.
1N - 4N	AC output.

PD8/PD8CB - Distribution Module

1P - 8P	AC output.
1N - 8N	AC output.



The lightning flash with arrowhead symbol within an equilateral triangle is intended to alert the user to the presence of an insulated DANGEROUS VOLTAGE within the product's enclosure that may be of sufficient magnitude to constitute an electric shock.



The exclamation point within an equilateral triangle is intended to alert the user to the presence of important operating and maintenance (servicing) instructions in the literature accompanying the appliance.



CAUTION
RISK OF ELECTRIC SHOCK
DO NOT OPEN



CAUTION: To reduce the risk of electric shock do not open enclosure. There are no user serviceable parts inside. Refer servicing to qualified service personnel.

Fig. 1 - ALTV248 and ALTV248CB

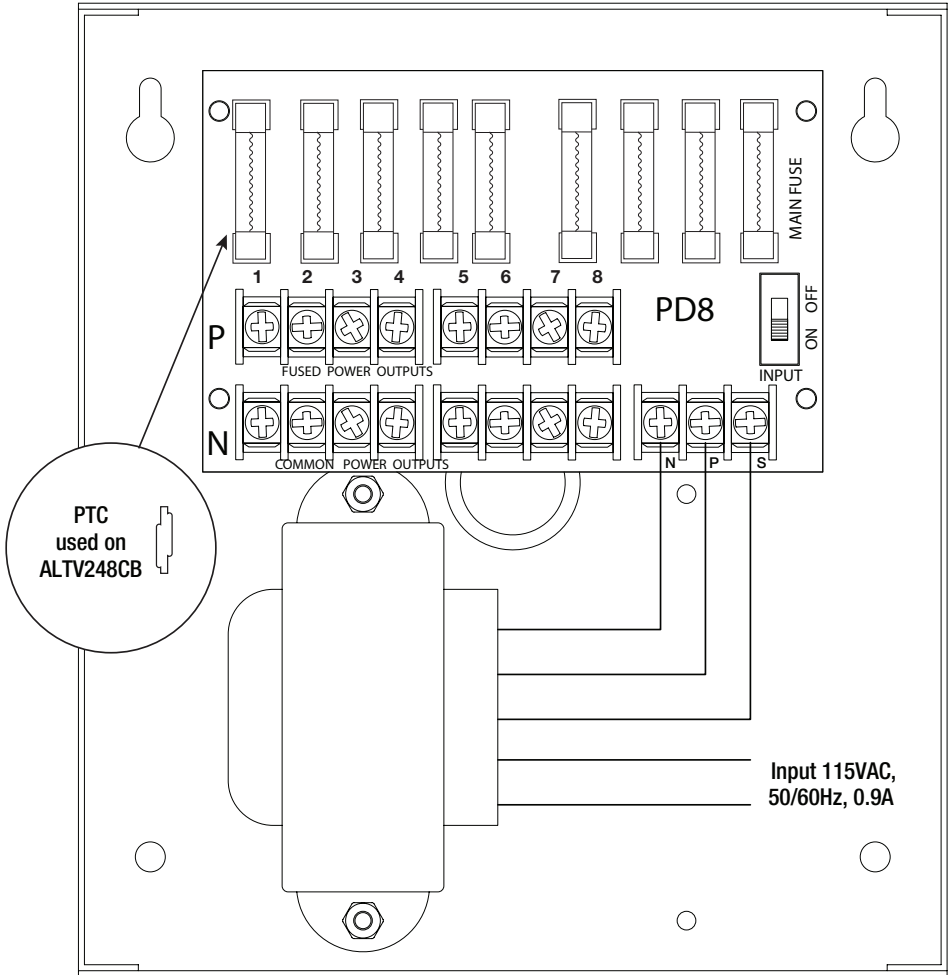

Voltage Selection Configuration

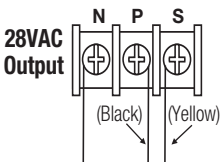
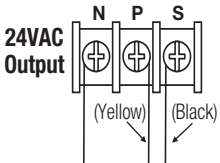

Terminal Blocks for Fig. 1

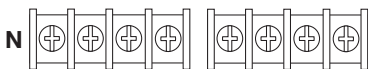
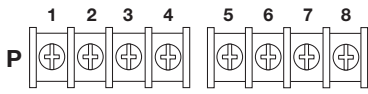

24VAC or 28VAC fuse or PTC protected outputs 1 through 8.

Fig. 2 - ALTV248175 and ALTV248175CB

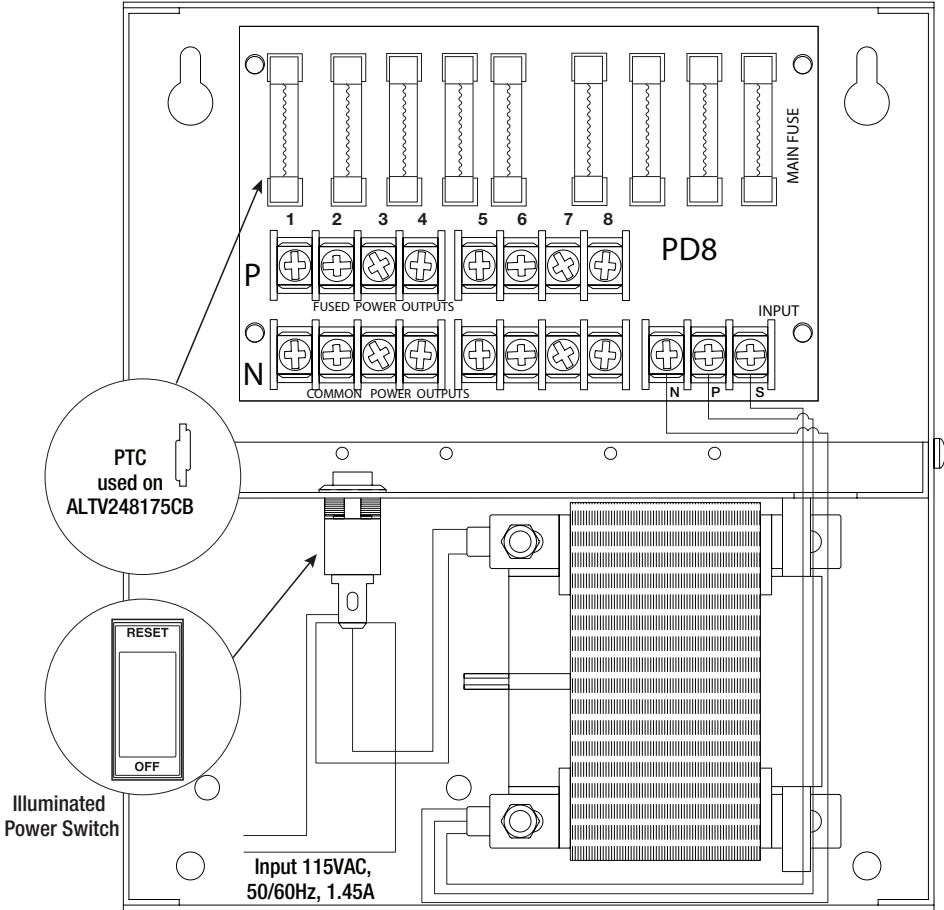

Voltage Selection Configuration

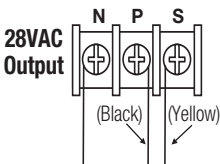
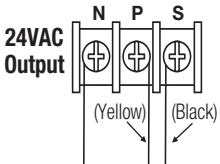

Terminal Blocks for Fig. 2

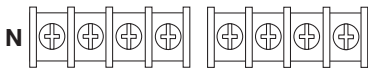
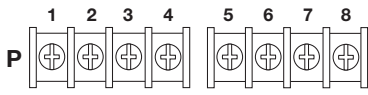

24VAC or 28VAC fuse or PTC protected outputs 1 through 8.

Fig. 3 - ALTV248300 and ALTV248300CB

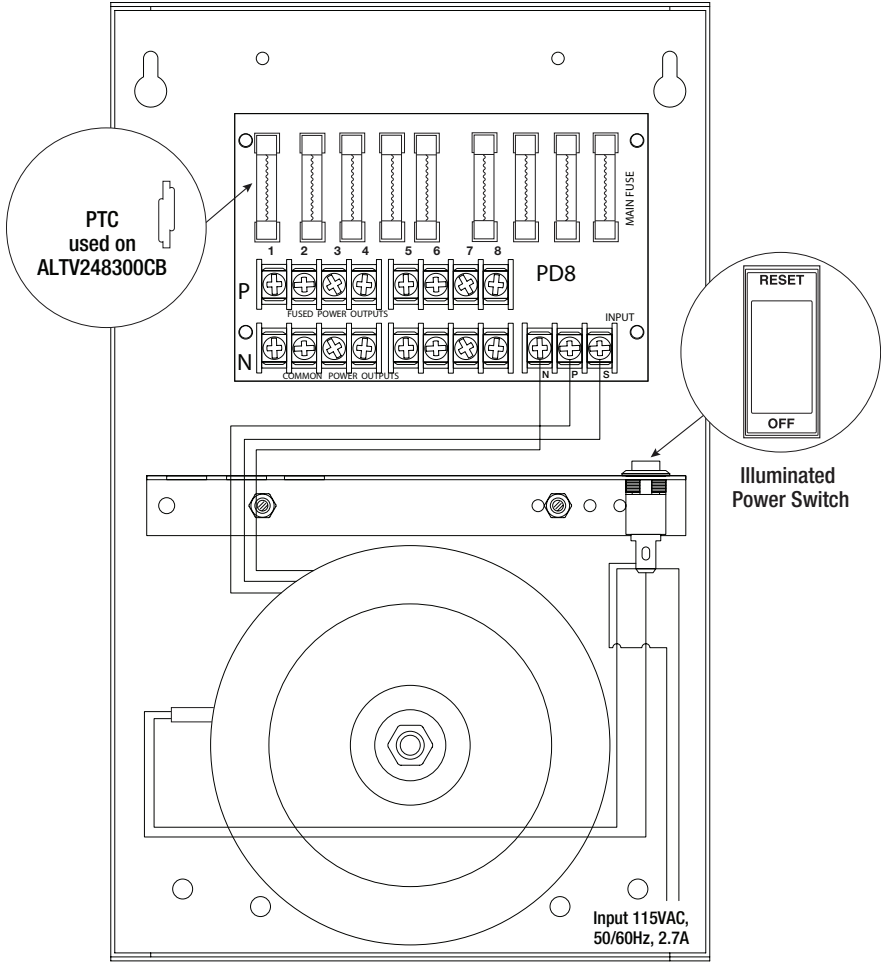

Voltage Selection Configuration

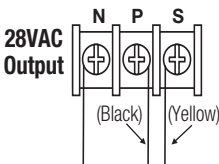
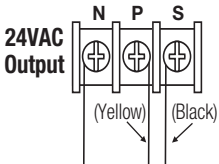

Terminal Blocks for Fig. 3

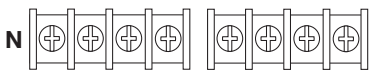
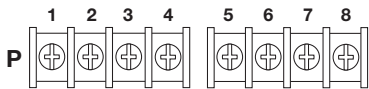

24VAC or 28VAC fuse or PTC protected outputs 1 through 8.

Fig. 4 - ALTV248600 and ALTV248600CB

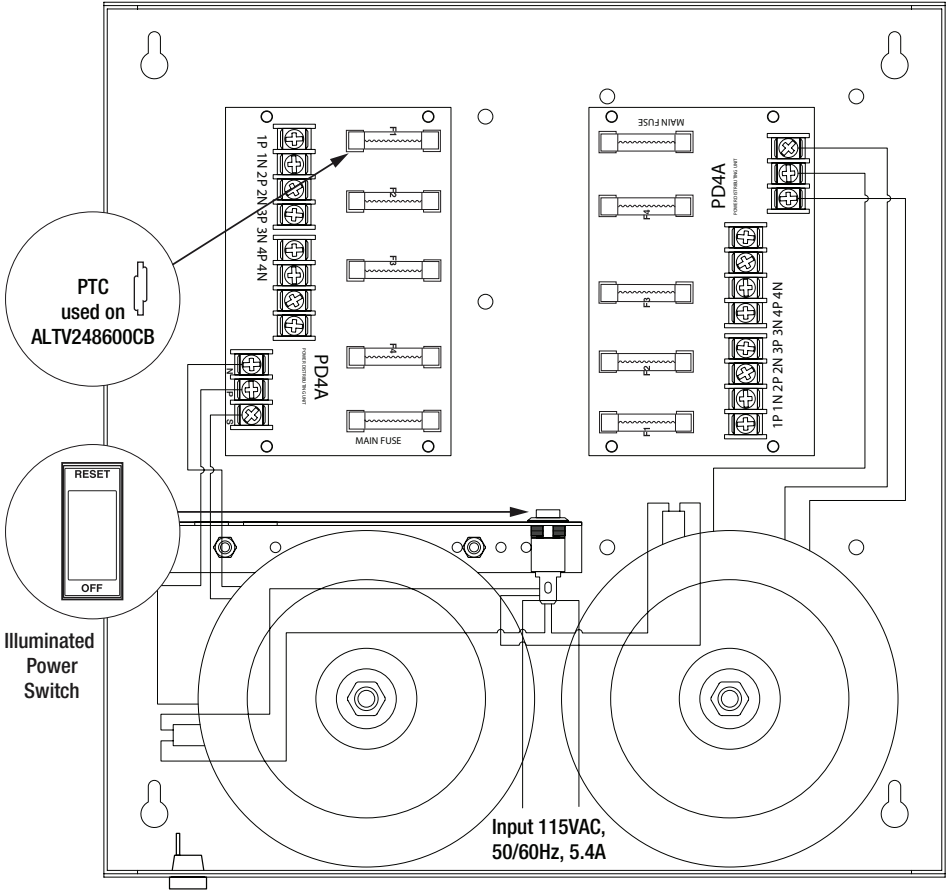

Voltage Selection Configuration

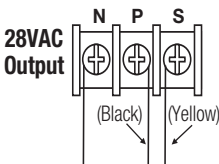
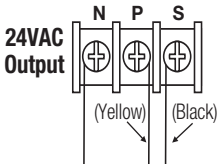

Terminal Blocks for Fig. 4

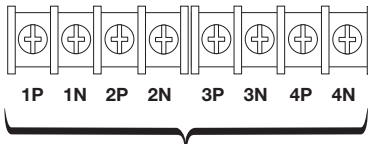

24VAC or 28VAC fuse or PTC protected outputs 1 through 4.

Enclosure Dimensions (H x W x D) for:

- ALTV248
- ALTV248CB
- ALTV248175
- ALTV248175CB

8.5" x 7.5" x 3.5" (215.9mm x 190.5mm x 88.9mm)

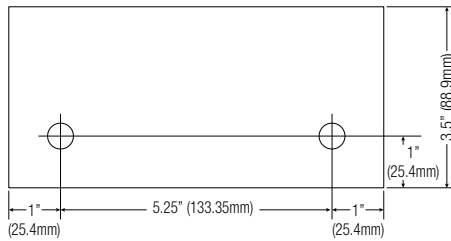
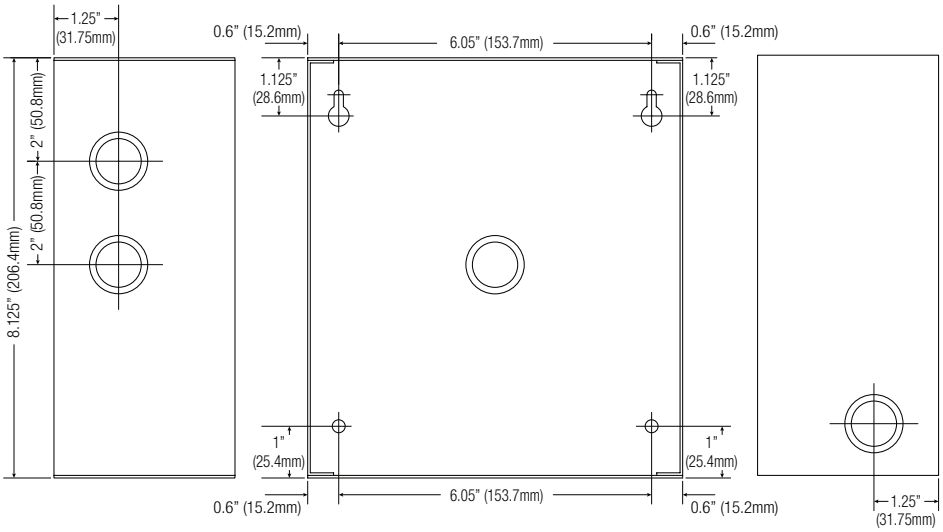
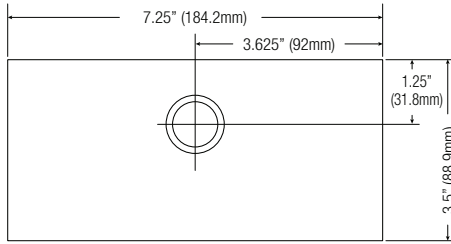

Enclosure Dimensions (H x W x D) for:

• ALTV248300 • ALTV248300CB

12.25" x 7.25" x 4.5" (311.15mm x 184.15mm x 114.3mm)

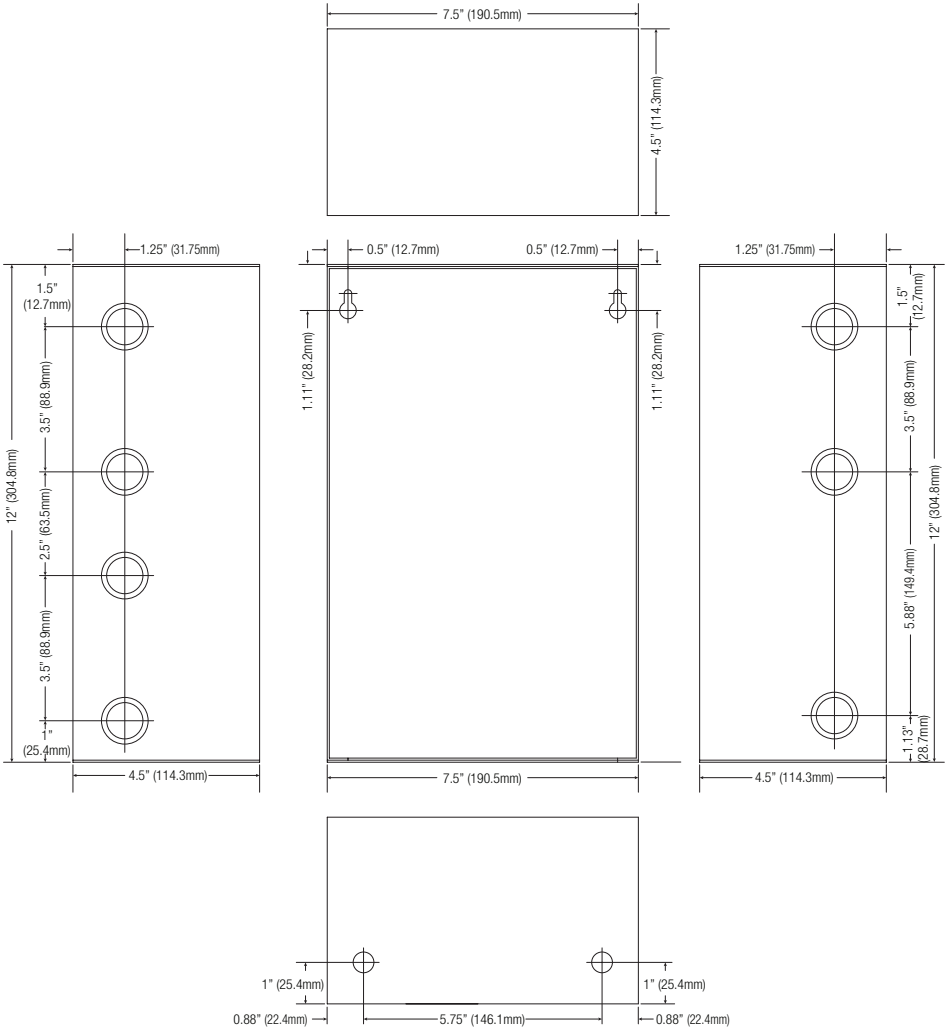

Enclosure Dimensions (H x W x D) for:

• ALTV248600 • ALTV248600CB

13.5" x 13" x 3.25" (342.9mm x 330.2mm x 82.6mm)

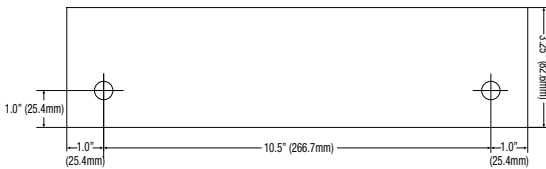
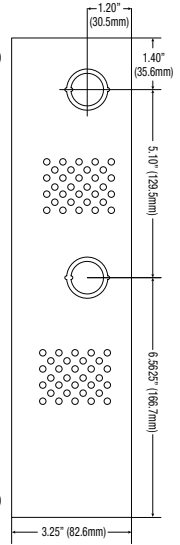
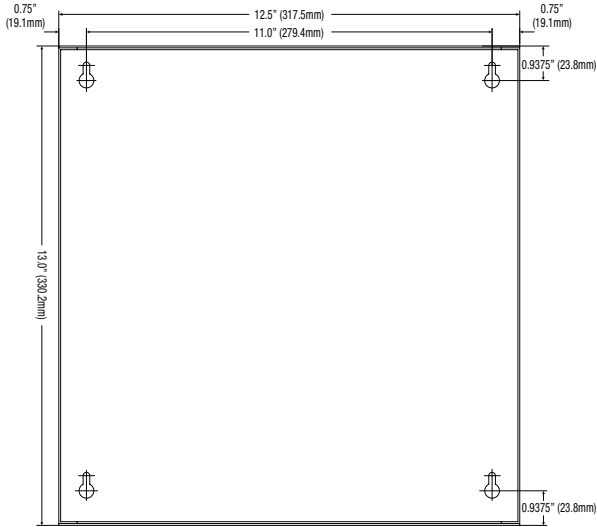
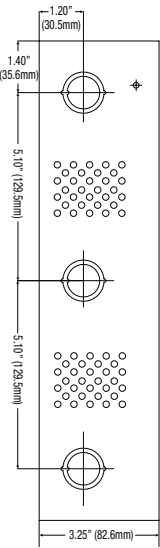
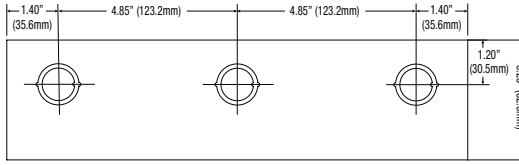

Notes:

Notes:

Altronix is not responsible for any typographical errors.

140 58th Street, Brooklyn, New York 11220 USA | 718-567-8181 | fax: 718-567-9056
website: www.altronix.com | e-mail: info@altronix.com | Lifetime Warranty
IIALTV248 Series J26U

