

**SHARP**<sup>®</sup>

**PN-C861H**

**PN-C751H**

**LCD MONITOR**

**OPERATION MANUAL**

**HDMI**<sup>™</sup>

**IMPORTANT:**

To aid reporting in case of loss or theft, please record the product's model and serial numbers in the space provided. The numbers are located in the rear of the product.



Model No.:

Serial No.:

U.S.A. ONLY

# IMPORTANT INFORMATION

**WARNING:** TO REDUCE THE RISK OF FIRE OR ELECTRIC SHOCK, DO NOT EXPOSE THIS PRODUCT TO RAIN OR MOISTURE.

	<b>CAUTION</b> RISK OF ELECTRIC SHOCK DO NOT OPEN	
CAUTION: TO REDUCE THE RISK OF ELECTRIC SHOCK, DO NOT REMOVE COVER. NO USER-SERVICEABLE PARTS INSIDE. REFER SERVICING TO QUALIFIED SERVICE PERSONNEL.		



The lightning flash with arrowhead symbol, within a triangle, is intended to alert the user to the presence of uninsulated “dangerous voltage” within the product’s enclosure that may be of sufficient magnitude to constitute a risk of electric shock to persons.



The exclamation point within a triangle is intended to alert the user to the presence of important operating and maintenance (servicing) instructions in the literature accompanying the product.

**WARNING:**

FCC Regulations state that any unauthorized changes or modifications to this equipment not expressly approved by the manufacturer could void the user’s authority to operate this equipment.

**NOTE:**

This equipment has been tested and found to comply with the limits for a Class A digital device, pursuant to Part 15 of the FCC Rules. These limits are designed to provide reasonable protection against harmful interference when the equipment is operated in a commercial environment. This equipment generates, uses, and can radiate radio frequency energy and, if not installed and used in accordance with the instruction manual, may cause harmful interference to radio communications. Operation of this equipment in a residential area is likely to cause harmful interference in which case the user will be required to correct the interference at his own expense.

This product utilizes a CR coin Lithium battery which contains a Perchlorate material. Special handling for this material may apply, California residents, See [www.dtsc.ca.gov/hazardouswaste/perchlorate/](http://www.dtsc.ca.gov/hazardouswaste/perchlorate/) Others, consult local environmental officers.

U.S.A. ONLY

To maintain compliance with EMC regulations, use shielded cables to connect to the following terminals: USB ports, Mini AV input terminal, HDMI input terminals, D-sub input terminal and Audio input terminal.

# DEAR SHARP CUSTOMER

---

Thank you for your purchase of a SHARP LCD product. To ensure safety and many years of trouble-free operation of your product, please read the Safety Precautions carefully before using this product.

## SAFETY PRECAUTIONS

---

Electricity is used to perform many useful functions, but it can also cause personal injuries and property damage if improperly handled. This product has been engineered and manufactured with the highest priority on safety. However, improper use can result in electric shock and/or fire. In order to prevent potential danger, please observe the following instructions when installing, operating and cleaning the product. To ensure your safety and prolong the service life of your LCD product, please read the following precautions carefully before using the product.

1. Read instructions — All operating instructions must be read and understood before the product is operated.
2. Keep this manual in a safe place — These safety and operating instructions must be kept in a safe place for future reference.
3. Observe warnings — All warnings on the product and in the instructions must be observed closely.
4. Follow instructions — All operating instructions must be followed.
5. Cleaning — Unplug the power cord from the power outlet before cleaning the product. Use a dry cloth to clean the product. Do not use liquid cleaners or aerosol cleaners. Do not use dirty cloths. Doing so may damage the product.
6. Attachments — Do not use attachments not recommended by the manufacturer. Use of inadequate attachments can result in accidents.
7. Water and moisture — Do not use the product near water. Do not install the product in a place where water may splash onto it. Be careful of equipment which drains water such as an air-conditioner.
8. Ventilation — The vents and other openings in the cabinet are designed for ventilation. Do not cover or block these vents and openings since insufficient ventilation can cause overheating and/or shorten the life of the product. Do not place the product on a sofa, rug or other similar surface, since they can block ventilation openings. Do not place the product in an enclosed place such as a bookcase or rack, unless proper ventilation is provided or the manufacturer's instructions are followed.
9. Power cord protection — The power cords must be routed properly to prevent people from stepping on them or objects from resting on them.
10. The screen used in this product is made of glass. Therefore, it can break when the product is dropped or applied with impact. Be careful not to be injured by broken glass pieces in case the screen breaks.
11. Overloading — Do not overload power outlets or extension cords. Overloading can cause fire or electric shock.
12. Entering of objects and liquids — Never insert an object into the product through vents or openings. High voltage flows in the product, and inserting an object can cause electric shock and/or short internal parts. For the same reason, do not spill water or liquid on the product.
13. Servicing — Do not attempt to service the product yourself. Removing covers can expose you to high voltage and other dangerous conditions. Request a qualified service person to perform servicing.
14. Repair — If any of the following conditions occurs, unplug the power cord from the power outlet, and request a qualified service person to perform repairs.
  - a. When the power cord or plug is damaged.
  - b. When a liquid was spilled on the product or when objects have fallen into the product.
  - c. When the product has been exposed to rain or water.
  - d. When the product does not operate properly as described in the operating instructions.

Do not touch the controls other than those described in the operating instructions. Improper adjustment of controls not described in the instructions can cause damage, which often requires extensive adjustment work by a qualified technician.
  - e. When the product has been dropped or damaged.
  - f. When the product displays an abnormal condition. Any noticeable abnormality in the product indicates that the product needs servicing.
15. Replacement parts — In case the product needs replacement parts, make sure that the service person uses replacement parts specified by the manufacturer, or those with the same characteristics and performance as the original parts. Use of unauthorized parts can result in fire, electric shock and/or other danger.
16. Safety checks — Upon completion of service or repair work, request the service technician to perform safety checks to ensure that the product is in proper operating condition.
17. Wall mounting — When mounting the product on a wall, be sure to install the product according to the method recommended by the manufacturer.
18. Heat sources — Keep the product away from heat sources such as radiators, heaters, stoves and other heat-generating products (including amplifiers).

# SAFETY PRECAUTIONS (Continued)

19. Batteries — Incorrect use of batteries may cause the batteries to burst or ignite. A leaky battery may corrode the equipment, dirty your hands or spoil your clothing. In order to avoid these problems, make sure to observe the precautions below:
  - Use the specified batteries only.
  - Install the batteries with due attention to the plus (+) and minus (-) sides of the batteries according to the instructions in the compartment.
  - Do not mix old and new batteries.
  - Do not mix batteries of different types. Voltage specifications of batteries of the same shape may vary.
  - Replace an exhausted battery with a new one promptly.
  - If you will not use the remote control for a long time, remove the batteries.
  - If leaked battery fluid gets on your skin or clothing, rinse immediately and thoroughly. If it gets into your eye, bathe your eye well rather than rubbing and seek medical treatment immediately. Leaked battery fluid that gets into your eye or your clothing may cause a skin irritation or damage your eye.
20. Usage of the monitor must not be accompanied by fatal risks or dangers that, could lead directly to death, personal injury, severe physical damage or other loss, including nuclear reaction control in nuclear facility, medical life support system, and missile launch control in a weapon system.
21. Do not stay in contact with the parts of the product that become hot for long periods of time. Doing so may result in low-temperature burns.
22. Do not modify this product.

## **WARNING:**

This is a Class A product. In a domestic environment this product may cause radio interference in which case the user may be required to take adequate measures.

An apparatus with CLASS I construction shall be connected to a MAIN socket outlet with a protective earthing connection.

## **STABILITY HAZARD**

If a monitor is not positioned in a sufficiently stable location, it can be potentially hazardous due to falling. Many injuries, particularly to children, can be avoided by taking simple precautions such as:

- Using fixing devices like wall mount brackets recommended by the manufacturer.
- Only using furniture that can safely support the monitor.
- Ensuring the monitor is not overhanging the edge of the supporting furniture.
- Not placing the monitor on tall furniture (for example, cupboards or bookcases) without anchoring both the furniture and the monitor to a suitable support.
- Not standing the monitors on cloth or other materials placed between the monitor and supporting furniture.
- Educating children about the dangers of climbing on furniture to reach the monitor or its controls.
- This equipment is not suitable for use in locations where children are likely to be present unsupervised.

## **Especially for child safety**

- Don't allow children to climb on or play with the monitor.
- Don't place the monitor on furniture that can easily be used as steps, such as a chest of drawers.
- Remember that children can become excited while watching a program, especially on a "larger than life" monitor. Care should be taken to place or install the monitor where it cannot be pushed, pulled over, or knocked down.
- Care should be taken to route all cords and cables connected to the monitor so that they cannot be pulled or grabbed by curious children.

# TIPS AND SAFETY INSTRUCTIONS

- The TFT color LCD panel used in this monitor is made with the application of high precision technology. However, there may be minute points on the screen where pixels never light or are permanently lit. Also, if the screen is viewed from an acute angle there may be uneven colors or brightness. Please note that these are not malfunctions but common phenomena of LCDs and will not affect the performance of the monitor.
- Do not display a still picture for a long period, as this could cause a residual image.
- Never rub or tap the monitor with hard objects.
- Please understand that SHARP CORPORATION bears no responsibility for errors made during use by the customer or a third party, nor for any other malfunctions or damage to this product arising during use, except where indemnity liability is recognized under law.
- This monitor and its accessories may be upgraded without advance notice.
- Do not use the monitor where there is a lot of dust, where humidity is high, or where the monitor may come into contact with oil or steam. Do not use in an environment where there are corrosive gases (sulfur dioxide, hydrogen sulfide, nitrogen dioxide, chlorine, ammonia, ozone, etc.). As this could lead to fire.
- Ensure that the monitor does not come into contact with water or other fluids. Ensure that no objects such as paper clips or pins enter the monitor as this could lead to fire or electric shock.
- Do not place the monitor on top of unstable objects or in unsafe places. Do not allow the monitor to receive strong shocks or to strongly vibrate. Causing the monitor to fall or topple over may damage it.
- Do not use the monitor near heating equipment or in places where there is likelihood of high temperature, as this may lead to generation of excessive heat and outbreak of fire.
- Do not use the monitor in places where it may be exposed to direct sunlight. Risk of cabinet deformation and failure if the monitor is used in direct sunlight.
- Please be sure to constantly remove dust and garbage that has attached to the ventilation opening. If dust collects in the ventilation opening or the inside of the monitor, it may lead to excessive heat, outbreak of fire, or malfunction. Please request a cleaning of the inside of the monitor from an authorized SHARP servicing dealer or service center.
- The power outlet shall be installed near the equipment and shall be easily accessible.
- Continuous operating time and warranty.  
This product is designed for a maximum daily use of 16 hours. Continual use in excess of 16 hours per day is not covered by the warranty.
- Do not touch the screen when the monitor power is turned on, it will lead to a malfunction. When this occurs, turn the monitor power off and then on.
- Do not operate the screen with a hard or pointed object such as a fingernail or pencil.
- If another USB device is connected to the computer to which the touch panel is connected, do not operate the USB device during touch panel input. Input may not take place correctly.
- To maintain stable operation, this monitor must be restarted once a day.

- If you or a third party uses the product incorrectly, or if the product is subjected to the effects of static electricity or electrical noise, or if the product malfunctions or is repaired, there is a risk that saved data will be corrupted or lost.
- Always back up important data to a USB flash drive.
- We bear no responsibility for protection of internal memory recorded content or related damages.

## The Power Cord

- Use only the power cord supplied with the monitor.
- Do not damage the power cord nor place heavy objects on it, stretch it or over bend it. Also, do not add extension cords. Damage to the cord may result in fire or electric shock.
- Do not use the power cord with a power tap. Adding an extension cord may lead to fire as a result of overheating.
- Do not remove or insert the power plug with wet hands. Doing so could result in electric shock.
- Unplug the power cord if it is not used for a long time.
- Do not attempt to repair the power cord if it is broken or malfunctioning. Refer the servicing to the service representative.

## Manual Scope

- Microsoft and Windows are either registered trademarks or trademarks of Microsoft Corporation in the United States and/or other countries.
- Apple, Mac and macOS are trademarks of Apple Inc., registered in the U.S. and other countries.
- The terms HDMI, HDMI High-Definition Multimedia Interface, and the HDMI Logo are trademarks or registered trademarks of HDMI Licensing Administrator, Inc.
- Intel and Intel Core are trademarks or registered trademarks of Intel Corporation or its subsidiaries in the U.S.A. and other countries.
- Google and Chrome OS are trademarks or registered trademarks of Google LLC.
- Ethernet is a registered trademark of Xerox Corporation.
- VESA is either registered trademark or trademark of Video Electronics Standards Association in the United States and/or other countries.
- All other brand and product names are trademarks or registered trademarks of their respective holders.
- Language of OSD menu used in this manual is English by way of example.
- Illustrations in this manual may not exactly represent the actual product or display.

## LED Backlight

- The LED backlight in this product has a limited lifetime.
  - \* If the screen gets dark or does not turn on, it may be necessary to replace the LED backlight.
  - \* This LED backlight is exclusive to this product and must be replaced by an authorized SHARP servicing dealer or service center. Please contact an authorized SHARP servicing dealer or service center for assistance.

# MOUNTING PRECAUTIONS

- This product is for indoor use.
  - A mounting bracket compliant with VESA specifications is required.
  - Since the monitor is heavy, consult your dealer before installing, removing or moving the monitor.
  - Mounting the monitor on the wall requires special expertise and the work must be performed by an authorized SHARP dealer. You should never attempt to perform any of this work yourself. Our company will bear no responsibility for accidents or injuries caused by improper mounting or mishandling.
  - Use the monitor with the surface perpendicular to a level surface.
  - When moving the monitor, be sure to hold the handles or the parts marked by  below. Do not grasp the screen or tray. This may cause product damage, failure, or injury.
- [PN-C861H]**

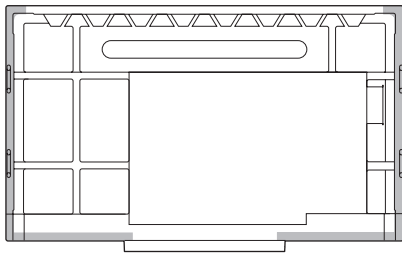

**[PN-C751H]**

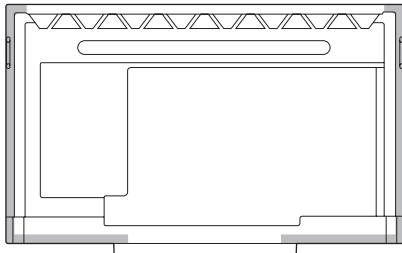

- This monitor should be used at an ambient temperature between 41°F (5°C) and 95°F (35°C). Provide enough space around the monitor to prevent heat from accumulating inside.

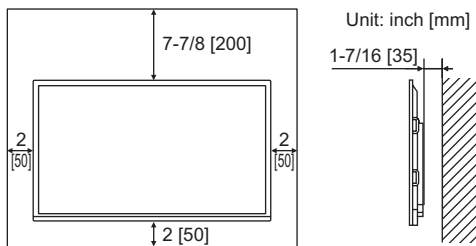

- If it is difficult to provide sufficient space for any reason such as the installation of the monitor inside a housing or of several units side-by-side, or if the ambient temperature may be outside of the range of 41°F (5°C) to 95°F (35°C), install a fan or take other measures to keep the ambient temperature within the required range.

# Contents

<b>IMPORTANT INFORMATION</b> .....	<b>3</b>	<b>Basic Operation</b> .....	<b>17</b>
<b>DEAR SHARP CUSTOMER</b> .....	<b>4</b>	About the home screen of APPLICATION mode.....	17
<b>SAFETY PRECAUTIONS</b> .....	<b>4</b>	Using the remote control unit .....	18
<b>TIPS AND SAFETY INSTRUCTIONS</b> .....	<b>6</b>	<b>Menu Items</b> .....	<b>20</b>
<b>MOUNTING PRECAUTIONS</b> .....	<b>7</b>	Displaying the menu screen.....	20
<b>Supplied Components</b> .....	<b>9</b>	<b>Controlling the Monitor with a computer (RS-232C) ...</b>	<b>21</b>
<b>System Requirements</b> .....	<b>9</b>	Computer connection .....	21
<b>Part Names</b> .....	<b>10</b>	Communication conditions .....	21
<b>Connecting Peripheral Equipment</b> .....	<b>12</b>	Communication procedure .....	21
<b>Connecting the Power Cord</b> .....	<b>14</b>	RS-232C command table.....	23
<b>Binding Cables</b> .....	<b>14</b>	<b>Specifications</b> .....	<b>25</b>
<b>Preparing the Remote Control Unit</b> .....	<b>15</b>	<b>Intellectual Property Rights and Other Matters</b> .....	<b>28</b>
Installing the batteries .....	15	<b>Mounting Precautions</b>	
Remote control operation range.....	15	<b>(For SHARP dealers and service engineers)</b> .....	<b>29</b>
<b>Turning Power On/Off</b> .....	<b>16</b>		
Turning on the main power.....	16		
Turning power on/off .....	16		



# Supplied Components

If any component should be missing, please contact your dealer.

- Liquid Crystal Display Monitor: 1
- Remote control unit: 1
- Cable clamp (affixing type): 3



- Power cord: 1
- Remote control unit battery: 2
- CD-ROM (Utility Disk for Windows): 1
- Setup Manual: 1

- Touch pen: 2
- Tray: 1
- Tray mounting screws (M3x15): 5
- USB cable: 1
- Cover SHARP logo: 1  
Place this sticker onto the SHARP logo to cover the logo.
- Wireless Adapter: 1

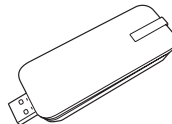

- \* SHARP Corporation holds authorship rights to the Utility Disk program. Do not reproduce it without permission.
- \* For environmental protection!  
Do not dispose of batteries in household waste. Follow the disposal instructions for your area.

# System Requirements

Hardware	Must have a USB 2.0 compliant port. CD-ROM drive required for software installation.
Operating system	Windows 8.1 (32-bit or 64-bit version), Windows 10 (32-bit or 64-bit version)
	macOS v10.13, v10.14
	Google Chrome OS Version 74 or later

Requirements when the software (Windows) supplied with this monitor is used.

CPU	Intel Core i5-6360U or faster Intel Core i7-6650U or faster recommended
Video Output	Must be capable of output at a Vsync of 60 Hz or higher
Memory	At least 4 GB
Free space on hard drive	At least 5 GB (free space separately required for data storage)

To use the touch panel, connect the USB cable (supplied) to your computer.

The touch panel operates with the standard driver of each operating system. On the Mac, operation is only possible in mouse mode.

Install Pen Software from the supplied CD-ROM.

When the Information Display Downloader is installed, you can check and download the most recent versions of the software programs and operation manuals.

To install the software, see the manual for each.

# Part Names

## ■ Front view

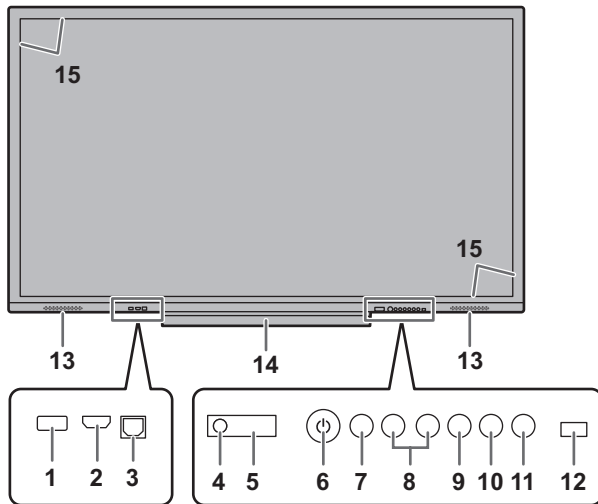

1. **USB port (USB 2.0 compliant)** (See page 12.)
2. **HDMI 1 input terminal** (See page 12.)
3. **TOUCH PANEL terminal 1 (for touch panel)** (See page 12.)
4. **Power LED** (See page 16.)
5. **Remote control sensor** (See page 15.)
6. **POWER button** (See page 16.)
7. **FREEZE button** (See page 18.)
8. **VOLUME +/- (Volume adjustment) buttons** (See page 18.)
9. **Touch On/Off button**  
Toggle the touch panel on and off. When turned off, only this button and the POWER button can be used.
10. **MENU button** (See page 19.)
11. **INPUT button** (See page 19.)
12. **Brightness sensor**
13. **Speakers**
14. **Tray**
15. **Infrared transmitter/receiver**

## ■ Rear view

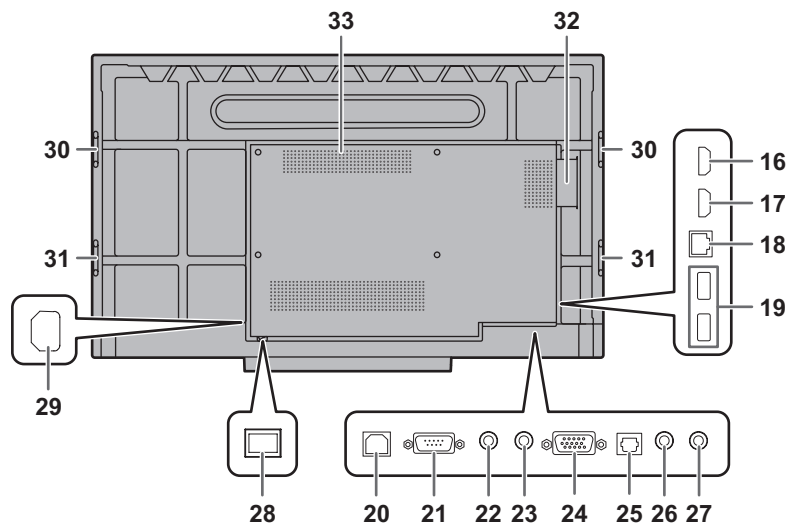

16. **HDMI 3 input terminal** (See page 12.)
17. **HDMI 2 input terminal** (See page 12.)
18. **LAN terminal** (See page 12.)
19. **USB ports (USB 2.0 compliant)** (See page 12.)
20. **TOUCH PANEL terminal 2 (for touch panel)** (See page 12.)
21. **RS-232C input terminal** (See page 13.)
22. **Audio output terminal** (See page 13.)
23. **Audio input terminal** (See page 13.)
24. **D-sub input terminal (VGA)** (See page 13.)
25. **Digital audio output (optical) terminal** (See page 13.)
26. **Mini AV input terminal** (See page 13.)
27. **Mini Component input terminal (YPBPR)** (See page 13.)
28. **Main power switch** (See page 16.)
29. **AC input terminal** (See page 14.)
30. **Handles**
31. **Handles (PN-C861H)**
32. **Expansion slot (OPS)**  
This section is used to connect optional hardware for function expansion. Offering this attachment location is not a guarantee that future compatible hardware attachments will be released.
33. **Vents**

### ! Caution

- Consult your SHARP dealer for attachment/detachment of optional parts.

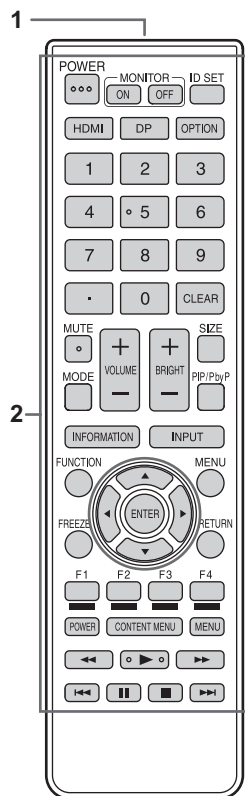
**Remote control unit**

1. Signal transmitter
2. Operation buttons (See page 18.)

# Connecting Peripheral Equipment

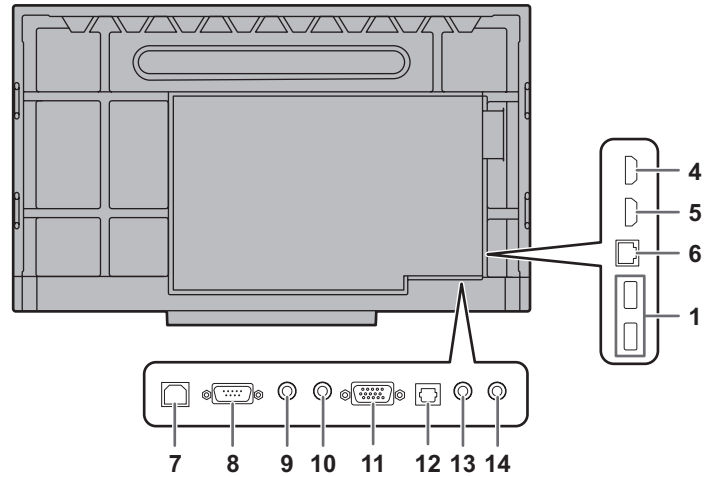
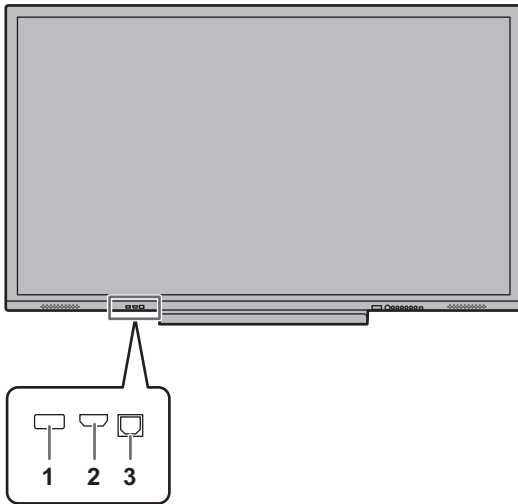

## ! Caution

- Be sure to turn off the main power switch and disconnect the plug from the power outlet before connecting/disconnecting cables. Also, read the manual of the equipment to be connected.
- Be careful not to confuse the input terminal with the output terminal when connecting cables. Accidentally reversing cables connected to the input and output terminals may cause malfunctions and other problems.
- Do not use any cable that has a damaged or deformed terminal. Using such cables may cause malfunctions.

## TIPS

- When using the touch panel, connect the USB cable to the computer.
- Images may not be displayed properly depending on the computer (video card) to be connected.
- Use the automatic screen adjustment when a computer screen is displayed for the first time using VGA (D-SUB) or when the setting of the computer is changed. The screen is adjusted automatically using Auto Adjust in PC Setting of the Picture menu.
- If the audio output from the playback device is connected directly to speakers or other devices, the video on the monitor may appear delayed from the audio portion. Audio should be played through this monitor by connecting the playback device to the monitor's audio input, and connecting the monitor's audio output to the speakers or other devices.

## 1. USB ports (USB 2.0 compliant) (5V, 500mA)

- Connect a USB flash drive to the USB port.
- Do not connect a USB device other than a USB flash drive.
- Before removing a USB flash drive, follow the steps for removal. (See page 13.)

### Supported USB flash drives

File System	FAT32
Capacity	Up to 32 GB (maximum file size 4 GB)

- Do not use a USB flash drive with a security function or a write protection function.
- Use a USB flash drive with a shape that can be inserted in the USB port. Some USB flash drives with special shapes cannot be inserted. Do not forcibly insert a USB flash drive. This may damage the connector and cause failure.

## 2. HDMI 1 input terminal

- Use a commercially available HDMI cable (conforming to the HDMI standard) that supports 4K.
- This terminal does not support HDMI CEC.

## 3. TOUCH PANEL terminal 1 (for touch panel)

- To use the touch panel with a computer, connect the touch panel to the computer with a USB cable.
- To use this terminal, connect your computer to the HDMI 1 input terminal on the front of the monitor.

## 4. HDMI 3 input terminal

## 5. HDMI 2 input terminal

- Use a commercially available HDMI cable (conforming to the HDMI standard) that supports 4K.

## 6. LAN terminal

- When Power Save Mode is Off, you can connect to a network and use the Wake on LAN function.

## 7. TOUCH PANEL terminal 2 (for touch panel)

- To use the touch panel with a computer, connect the touch panel to the computer with a USB cable.
- To use this terminal, connect your computer to the video input terminal on the rear of the monitor.

### 8. RS-232C input terminal

- You can control the monitor from a computer by connecting a commercially available RS-232 straight cable between these terminals and the computer. The terminal on the monitor is a female-type connector.

### 9. Audio output terminal

- The output sound varies depending on the input mode.

### 10. Audio input terminal

- Use an audio cable without resistance.

### 11. D-sub input terminal (VGA)

### 12. Digital audio output (optical) terminal

- Audio that is input into the monitor is output.
- Connect using a commercially available audio digital cable.
- The output sound varies depending on the input mode.
- You can adjust the volume with volume adjustment.

### 13. Mini AV input terminal

- Change the input mode to AV.
- A conversion cable must be purchased separately.

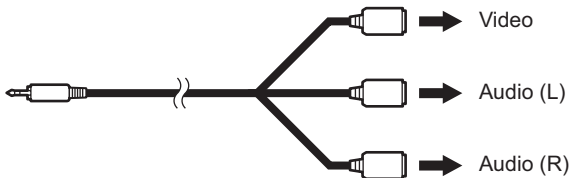

### 14. Mini Component input terminal (YPBPR)

- Change the input mode to YPBPR.
- A conversion cable must be purchased separately.

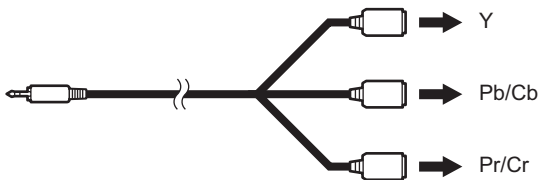

## ■How to remove a USB flash drive

- Start File Explorer. (See page 17.)
- Touch  of the device you want to unmount.

# Connecting the Power Cord

## ! Caution

- Use only the power cord supplied with the monitor.
1. Turn off the main power switch.
  2. Plug the power cord (supplied) into the AC input terminal.
  3. Plug the power cord (supplied) into the power outlet.

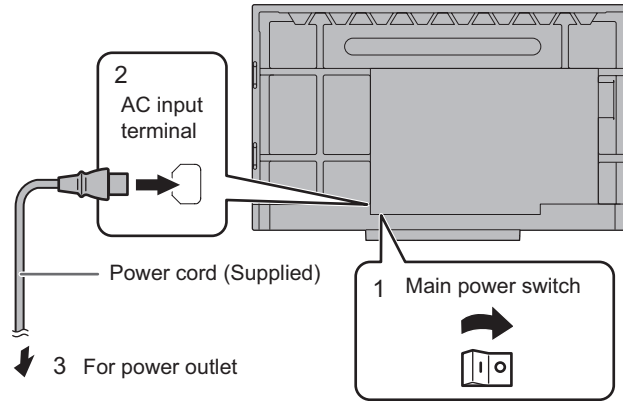

# Binding Cables

The supplied cable clamps can be used to clamp the power cord and cables connected to the back of the monitor.

Attach the supplied cable clamps (affixing type) to a flat surface, removing any dust or dirt before attaching. Do not attach over a vent.

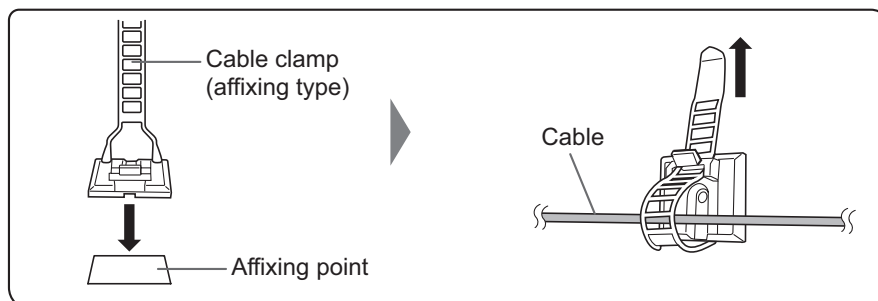

# Preparing the Remote Control Unit

## Installing the batteries

1. Place your finger on the part marked with the ▲, and then pull the cover off.

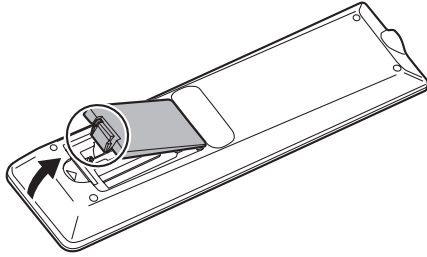

2. See the instructions in the compartment and put in the batteries (R03 or LR03 (“AAA” size) x 2) with their plus (+) and minus (-) sides oriented correctly.
3. Close the cover.

### TIPS

- When the batteries become exhausted, replace them with new (commercially available) batteries.
- The supplied batteries may become exhausted quickly depending on how they are stored.
- If you will not be using the remote control for a long time, remove the batteries.
- Use manganese or alkaline batteries only.

## Remote control operation range

The operation range of the remote control unit is approx. 16.4 feet (5 m) at an angle of approx 10° from the center to the top/bottom/right/left of the remote control sensor.

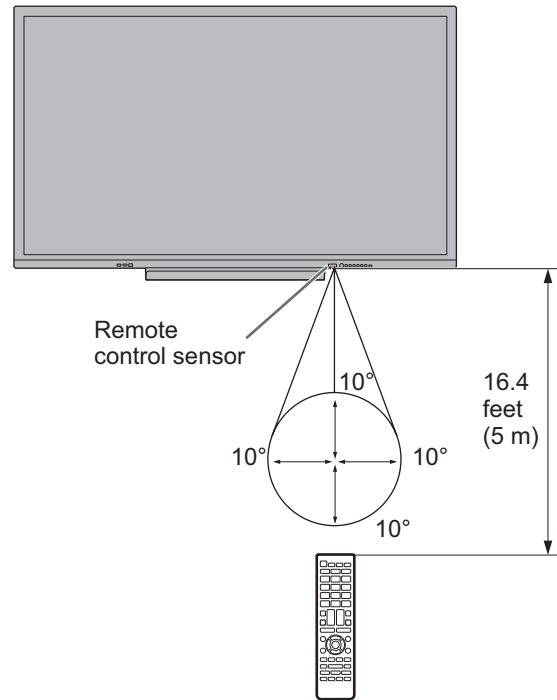

### TIPS

- Do not expose the remote control unit to shock by dropping or stepping on it. This could lead to a malfunction.
- Do not expose the remote control unit to liquids, and do not place it in an area with high humidity.
- The remote control unit may not work properly if the remote control sensor is under direct sunlight or strong lighting.
- Objects between the remote control unit and the remote control sensor may prevent proper operation.
- Replace the batteries when they run low as this may shorten the remote control's operation range.
- If a fluorescent light is illuminated near the remote control unit, it may interfere with proper operation.
- Do not use it with the remote control of other equipment such as air conditioner, stereo components, etc.

# Turning Power On/Off

## ! Caution

- Turn on the monitor first before turning on the computer or playback device.
- When switching the main power switch or the POWER button off and back on, always wait for at least 5 seconds. A short interval may result in a malfunction.

## Turning on the main power

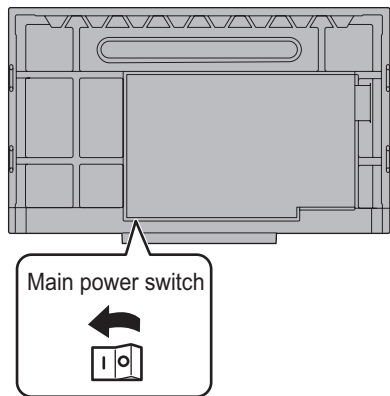

When you turn on the main power, the monitor enters standby mode.

## ! Caution

- The main power must be turned on/off with the main power switch. Do not connect/disconnect the power cord or turn the breaker on/off while the main power switch is on.
- For a complete electrical disconnection, pull out the main plug.

## Turning power on/off

Press the POWER button to turn the power ON/OFF. You can also turn the power ON/OFF by pressing the MONITOR ON button/MONITOR OFF button on the remote control unit.

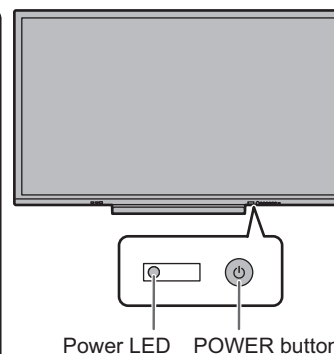
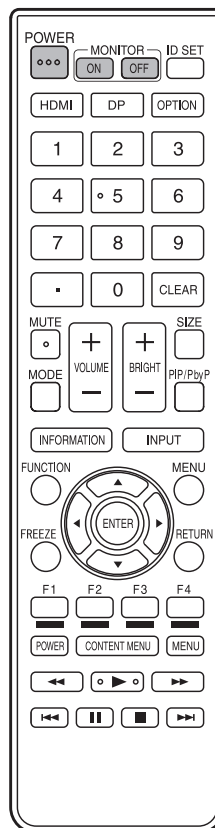

Status	Status of the monitor
Blue lit	Power on
Red lit	Power off (Standby mode)

## TIPS

- When the monitor is turned on for the first time after being shipped from the factory, the settings screen appears. In some cases it may take time for the settings screen to appear, however, continue waiting until the screen appears.
- When the main power switch is off, the monitor cannot be turned on.









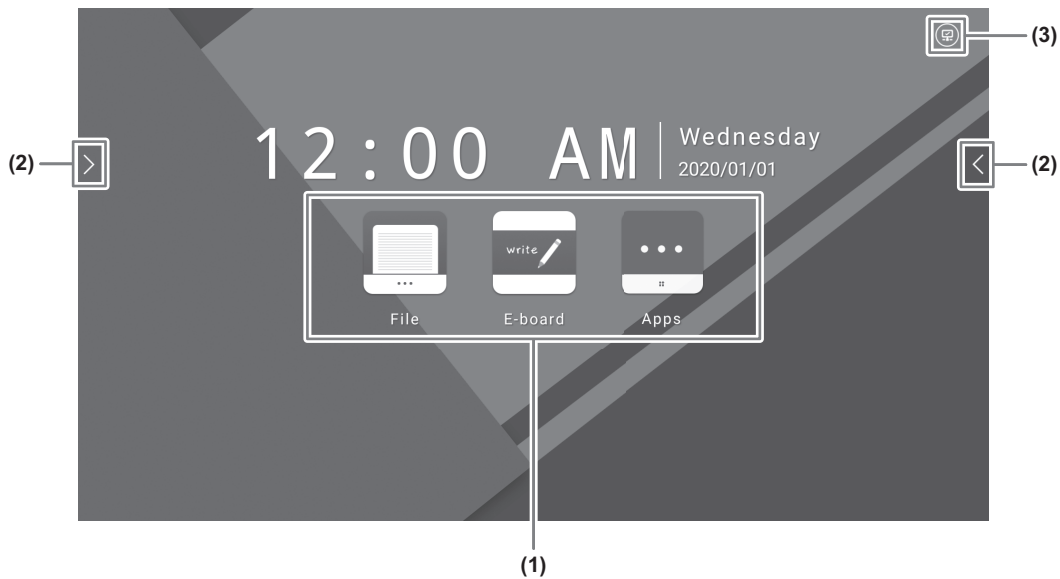





# Basic Operation

## About the home screen of APPLICATION mode

This appears when the input mode is changed to APPLICATION.



- (1)  Start File Explorer.
-  Start E-board.
-  Display the list of applications.
-  Start File Explorer.
-  Display the side menu.
-  Start E-board.
-  Start EShareServer.
  
- (2) Touch to display the settings menu.
  -  Go back to the previous screen.
  -  Return to the home screen of APPLICATION mode.
  -  Start Note.
  -  Display the side menu.
  -  Display the change input menu.
  
- (3) Display the menu of system-related settings.

## Using the remote control unit

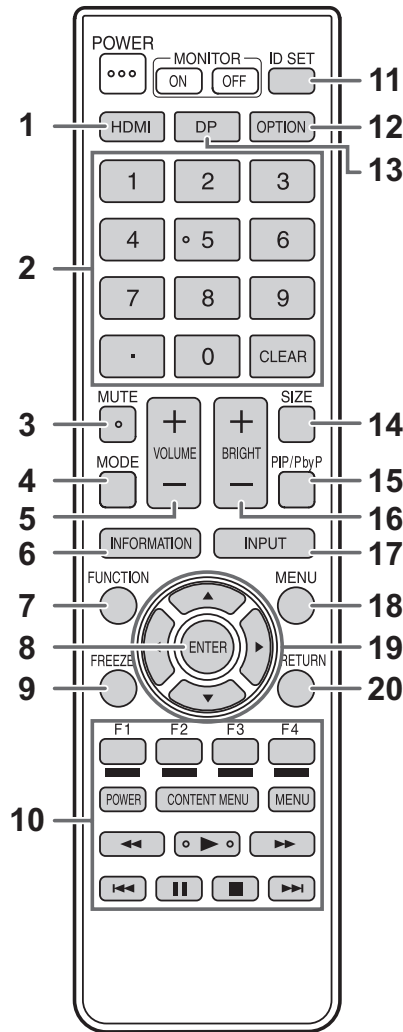

### 1. HDMI

Switch the input mode to HDMI 1, HDMI 2 or HDMI 3.

### 2. Numeric input buttons

These buttons are used for setting such as LAN setting.

### 3. MUTE

Turns off the volume temporarily.

Press the MUTE button again to turn the sound back to the previous level.

### 4. MODE (Display mode selection)

In video input mode (other than APPLICATION), each time you press this button, the picture mode changes in the following order:

STD (Standard) → Vivid → High Illuminance → STD...

- High Illuminance is a display with colors suited to bright locations.

### 5. VOLUME +/- (Volume adjustment)

Press + or - to adjust the volume.

### 6. INFORMATION

In video input mode (other than APPLICATION), use this to display the input terminal and the signal.

### 7. FUNCTION

Use this to display the Function menu. Press the FUNCTION button, and then press the MENU button within 10 seconds.

### 8. ENTER

Confirms the setting.

### 9. FREEZE

Freezes the video shown on the monitor.

To cancel, press any button other than the POWER button, MUTE button or VOLUME button.

In some cases a residual image may occur. Do not freeze the video for a long time.

### 10. Buttons for playing the files or operating the HDMI-connected device

When used for playing the files, the buttons that can be used vary depending on the file that is played.

When HDMI CEC is set to On, only the POWER button is enabled for the device connected through the HDMI interface.

### 11. ID SET

This is not used with this monitor.

### 12. OPTION

Switch the input mode to APPLICATION or OPS.

### 13. DP (DisplayPort)

This is not used with this monitor.

### 14. SIZE (Screen size selection)

In video input mode (other than APPLICATION), each time you press this button, screen size is changed.

### 15. PIP/PbyP

This is not used with this monitor.

### 16. BRIGHT +/- (Brightness adjustment)

Press + or - to adjust the brightness.

**17. INPUT (Input mode selection)**

The menu is displayed.

Press the ▲ or ▼ button to select the input mode, and press the ENTER button to enter.

Input mode	Video	Audio
APPLICATION	APPLICATION	APPLICATION
HDMI 1	HDMI 1 input terminal	HDMI 1 input terminal
HDMI 2	HDMI 2 input terminal	HDMI 2 input terminal
HDMI 3	HDMI 3 input terminal	HDMI 3 input terminal
VGA	D-sub input terminal	Audio input terminal
AV	Mini AV input terminal	Mini AV input terminal
YPBPR	Mini Component input terminal	Audio input terminal
OPS	Expansion slot	Expansion slot

**18. MENU**

Displays the menu screen. (See page 20.)

**19. Cursor**

These buttons are used to perform operations such as selecting items, changing adjustment values, and moving the cursor.

**20. RETURN**

Returns to the previous screen.

# Menu Items

## Displaying the menu screen

Video and audio adjustment and settings of various functions are enabled.

### ! Caution

- Do not turn the main power switch off while the menu items are being displayed. Doing so may initialize the settings.

## ■ How to display the menu

### Display a video menu



1. Change to a video input mode (other than APPLICATION).
2. Press the MENU button.

The menu will be displayed.





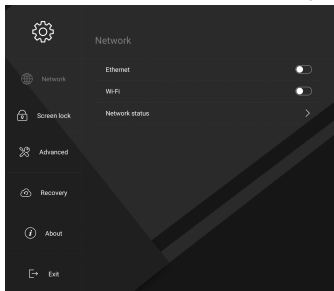

### Display the side menu

1. Touch  or  on the side of the screen, and touch .

-  : Enable or disable LAN (Ethernet) connection.
-  : Enable or disable wireless LAN connection.
-  : Display the system settings menu.  
In the APPLICATION mode, you can also press the MENU button to display the menu.



-  : You can use the timer/stopwatch. Set a time to use as a timer.
-  : Lock the screen. Double-click to unlock. You can set a password for unlocking the screen.
-  : Adjust the volume.
-  : Adjust the brightness. Select Auto to automatically adjust the screen brightness according to lighting conditions and the surrounding brightness.

# Controlling the Monitor with a computer (RS-232C)

You can control this monitor from a computer via RS-232C (COM port) on the computer.

## Computer connection

Connect with RS-232 straight cable between the computer's COM port (RS-232C connector) and the RS-232C input terminal on the monitor. The terminal on the monitor is a female-type connector.

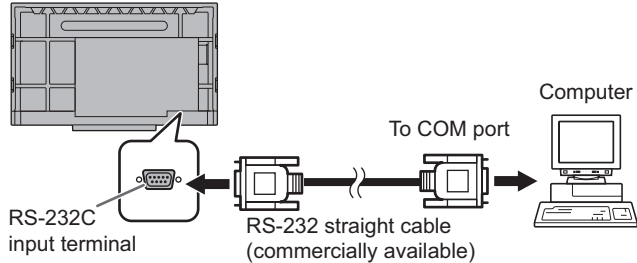

## Communication conditions

Set the RS-232C communication settings on the computer to match the monitor's communication settings as follows:

Baud rate	9600bps
Data length	8 bits
Parity bit	None

Stop bit	1 bit
Flow control	None

## Communication procedure

### Command format

When a command is sent from the computer to the monitor, the monitor operates according to the received command and sends a response message to the computer.

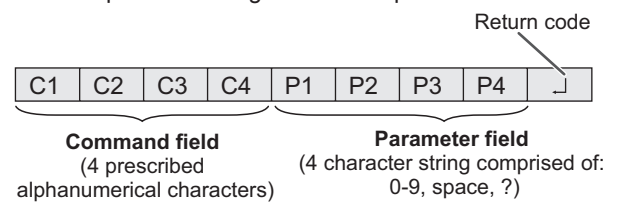

Example: VOLM0030  
VOLM \_ \_ 30

- \* Be sure to input 4 characters for the parameter. Pad with spaces (" ") if necessary.  
(" " is a return code (0DH, 0AH or 0DH))  
Wrong : VOLM30  
Right : VOLM \_ \_ 30

If a command has "R" listed for "Direction" in the "RS-232C command table" on page 23, the current value can be returned by using "?" as the parameter.

Example:

VOLM ? ? ? ? ← From computer to monitor (How much is current volume setting?).

30 ← From monitor to computer (Current volume setting: 30).

### TIPS

- Send Command field, Parameter field and Return code at the same time. When sending a command manually in 1 character units and it takes more than 2 seconds, the command function does not work.

# Controlling the Monitor with a computer (RS-232C)

## ■Response code format

When a command has been executed correctly

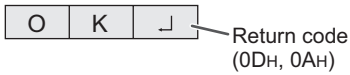

A response is returned after a command is executed.

When a command has not been executed

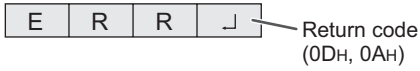

### TIPS

- “ERR” is returned when there is no relevant command or when the command cannot be used in the current state of the monitor.
- If communication has not been established for reasons such as a bad connection between the computer and monitor, nothing is returned (not even ERR).
- “ERR” may be returned when a command cannot be received correctly due to interference from the surrounding environment. Please ensure that the system or software resends the command if this occurs.

If execution of the command is taking some time



When the following commands are used, “WAIT” is returned. In this case, a value will be returned if you wait a while. Do not send any command during this period.

- Commands which return WAIT:  
RSET, POWR, INPS, WIDE, BOMD

## ■Communication interval

- After OK or ERR is returned, you must send the following commands.  
To set a timeout for the command response, specify 10 seconds or longer.
- Provide an interval of 100 ms or more between the command response and the transmission of the next command.

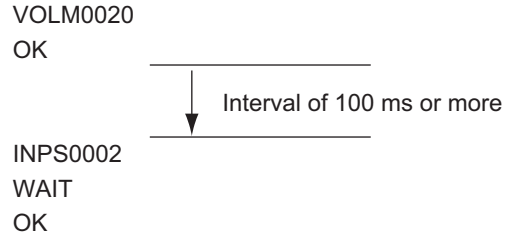

### TIPS

- When ALL RESET is executed, the monitor enters standby mode. Wait at least 1 minute before sending the next command. If you execute power “On” after ALL RESET, it will take time for the monitor to start up, so wait at least 5 minutes before sending the next command.
- Before sending a power “On” or “Off” command, it is recommended that you perform buffer clear at the sending application side.
- After executing a power “On” or “Off” command, wait at least 1 minute before sending the next command.

## RS-232C command table

### How to read the command table

- Command: Command field (See page 21.)
- Direction: W When the "Parameter" is set in the parameter field (see page 21), the command functions as described under "Control/Response Contents".  
 R The returned value indicated under "Reply" can be obtained by setting "???" or "???" in the parameter field. (See page 21.)
- Parameter: Parameter field (See page 21.)
- Reply: Response (Returned value)

### TIPS

- In the standby mode, the only command that is used is Power control.

## Power control/Input mode selection

Function	Command	Direction	Parameter	Reply	Control/Response contents	
Power control	POWR	W	0		Switches to standby mode.	
			1		Returns from standby mode.	
		R		0		Standby mode
				1		Normal mode
Input mode selection	INPS	W	0		Toggle change for input mode.	
			2		VGA	
			3		YPBPR	
			4		AV	
			10		HDMI 1	
			13		HDMI 2	
			18		HDMI 3	
			21		OPS	
					"ERR" when nothing is attached in the expansion slot.	
					APPLICATION	
		R		2		VGA
				3		YPBPR
				4		AV
				10		HDMI 1
		13		HDMI 2		
		18		HDMI 3		
		21		OPS		
		24		APPLICATION		

## Picture menu

Function	Command	Direction	Parameter	Reply	Control/Response contents
BRIGHT	VLMP	WR	0-100	0-100	"ERR" when Auto and Energy Saving are in effect.
SIZE (Screen size selection)	WIDE	W	0	0	Toggle change for input mode.
		WR	1-5	1-5	1: 16:9, 2: Dot by Dot, 3: 4:3, 4: Zoom1, 5: Zoom2

## Sound menu

Function	Command	Direction	Parameter	Reply	Control/Response contents
VOLUME	VOLM	WR	0-100	0-100	
MUTE AUDIO	MUTE	WR	0-1	0-1	0: OFF, 1: ON

## Controlling the Monitor with a computer (RS-232C)

### Others

Function		Command	Direction	Parameter	Reply	Control/Response contents
INFORMATION	Model	INF1	R		Value	
	Serial no.	SRNO	R		Value	
ALL RESET		RSET	W	0		ALL RESET
BACKLIGHT OFF		BOMD	W	0		Turn backlight off
				1		Turn backlight on
		R		0		Backlight off
				1		Backlight on
Check the resolution		PXCK	R		-	Returns current resolution in the form of hhh, vvv.



# Specifications

## ■Product Specifications

Model	PN-C861H		PN-C751H	
LCD component	86" Class [85-9/16 inch (217.4 cm) diagonal] TFT LCD		75" Class [74-1/2 inch (189.3 cm) diagonal] TFT LCD	
Max. resolution (pixels)	3840 x 2160			
Max. colors	Approx. 1.07 billion colors			
Pixel pitch	0.4935 mm (H) × 0.4935 mm (V)		0.4296 mm (H) × 0.4296 mm (V)	
Brightness (typical)	400 cd/m <sup>2</sup> *1			
Contrast ratio (typical)	1200: 1			
Viewing angle	178° right/left/up/down (contrast ratio ≥ 10)			
Screen active area inch (mm)	74-5/8 (W) x 41-15/16 (H) (1895.0 x 1066.0)		64-15/16 (W) x 36-9/16 (H) (1649.7 x 927.9)	
Computer input signal	Analog RGB (0.7 Vp-p) [75 Ω]			
Sync signal	Horizontal/vertical separate (TTL: positive/negative)			
Plug and play	VESA DDC2B			
Input terminals	Video	Mini D-sub 15 pin, 3 rows x 1 HDMI x 3 Mini AV in x 1 Mini YPbPr x 1 (Component)		
	Audio	3.5 mm mini stereo jack x 1		
	Serial (RS-232C)	D-sub 9 pin x 1		
Output terminals	Audio	3.5 mm mini stereo jack x 1 Digital audio output (optical) x 1		
	System	CPU	Arm Cortex - A53 processor (quad core)	
		Memory	1GB	
		Storage	8GB	
		LAN terminal	10BASE-T/100 BASE-TX (Wake on LAN only)	
Wireless LAN	IEEE802.11ac/n/a/g/b compliant (When a wireless adapter is connected)			
USB	2.0 compliant (Type A) x 3			
Expansion slot	19 V, 4.74 A (power supplied when expanding the functions with an optional part)			
Speaker output	10 W + 10 W			
Touch Panel	Detection method	Infrared blocking detection method		
	Computer connector	USB (2.0 compliant) (Type B) x 2		
Power requirement	AC 100 - 240 V, 5.9 A, 50/60 Hz		AC 100 - 240 V, 5.2 A, 50/60 Hz	
Operating temperature *2 *3	41°F to 95°F (5°C to 35°C)			
Operating humidity *3	20% to 80% (no condensation)			
Power consumption *4 (standby mode *5)	530 W (0.5 W)		460 W (0.5 W)	
Dimensions inch (mm) (excluding protrusions)	Approx. 78-1/4 (W) x 4-7/16 (D) x 46-1/4 (H) (1988 x 113 x 1175)		Approx. 68-5/16 (W) x 4-1/8 (D) x 40-13/16 (H) (1735 x 105 x 1036)	
Weight lbs. (kg)	Approx. 176.4 (80)		Approx. 134.5 (61)	

\*1 Brightness will depend on input mode and other picture settings. Brightness level will decrease over time. Due to the nature of the equipment, it is not possible to precisely maintain a constant level of brightness. This is the brightness of the LCD panel, not the brightness of the product.

\*2 Temperature condition may change when using the monitor together with the optional equipments recommended by SHARP. In such cases, please check the temperature condition specified by the optional equipments.

\*3 In addition, check the requirements of the computer and other devices to be connected, and make sure that all requirements are satisfied.

\*4 When an option is installed in the expansion slot. When an option is not installed, PN-C861H: 420 W, PN-C751H: 360 W.

\*5 When Power Save Mode is set to On.

When Power Save Mode is set to Off, and no optional part is attached: 2.0 W

As a part of our policy of continuous improvement, SHARP reserves the right to make design and specification changes for product improvement without prior notice. The performance specification figures indicated are nominal values of production units. There may be some deviations from these values in individual units.

# Specifications

## ■ Dimensional Drawings

Note that the values shown are approximate values.

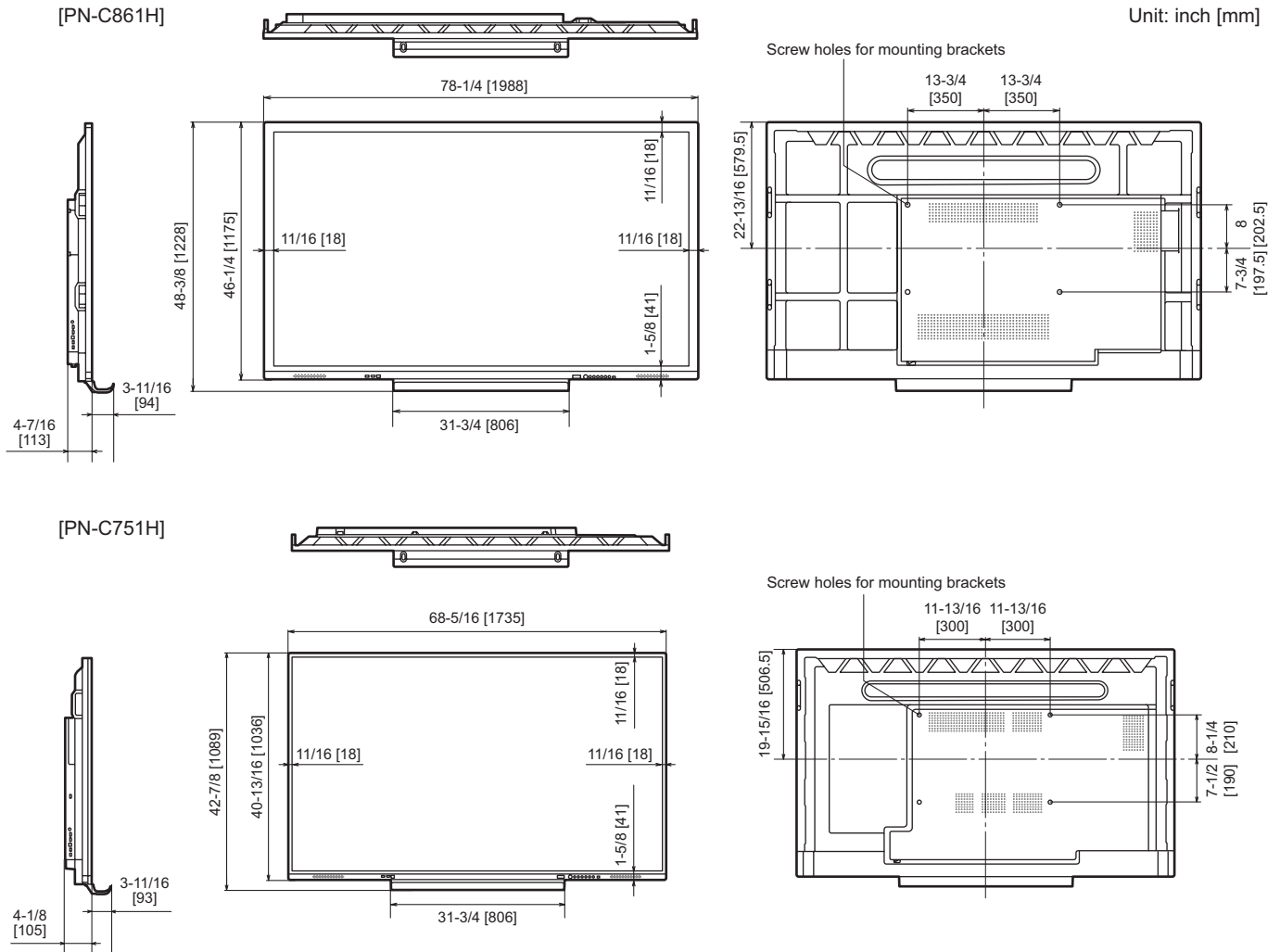

When mounting the monitor, be sure to use a wall-mount bracket that complies with the VESA-compatible mounting method. SHARP recommends using M8 screws and tighten the screws. Note that screw hole depth of the monitor is 1/2 inch (12 mm). Loose mounting may cause the product to fall, resulting in serious personal injuries as well as damage to the product. The screw and hole should come together with over 3/8 inch (10 mm) length of thread. Use a bracket which has been approved for UL1678 standard, and which can endure at least 4 times or more the weight of the monitor.

## ■ Channels that can be used in wireless LAN

Standard	Channel	Frequency band (center frequency)
IEEE802.11 b/g/n	1-11ch	2412-2462MHz
IEEE802.11 ac/a/n	36/40/44/48ch	5180-5240MHz
	52/56/60/64ch	5260-5320MHz
	100/104/108/112/116/132/136/140ch	5500-5700MHz
	149/153/157/161/165ch	5745-5825MHz

This device is restricted to indoor use due to its operation in the 5.15 GHz to 5.25 GHz frequency range. FCC requires this product to be used indoors for frequency range 5.15 GHz to 5.25 GHz to reduce the potential for harmful interference to co-channel Mobile Satellite systems. High power radars are allocated as primary users of the 5.25 GHz to 5.35 GHz and 5.65 GHz to 5.85 GHz bands. These radar stations can cause interference with and/or damage this device.

# Intellectual Property Rights and Other Matters

## ■ Information on the software license for this product

### Software composition

The software included in this product is comprised of various software components whose individual copyrights are held by SHARP or by third parties.

### Software developed by SHARP and open source software

The copyrights for the software components and various relevant documents included with this product that were developed or written by SHARP are owned by SHARP and are protected by the Copyright Act, international treaties, and other relevant laws. This product also makes use of freely distributed software and software components whose copyrights are held by third parties. These include software components covered by a GNU General Public License (hereafter GPL), a GNU Lesser General Public License (hereafter LGPL) or other license agreement.

### Obtaining source code

Some of the open source software licensors require the distributor to provide the source code with the executable software components. GPL and LGPL include similar requirements. For information on obtaining the source code for the open source software and for obtaining the GPL, LGPL, and other license agreement information, visit the following website:

[https://jp.sharp/business/lcd-display/support/download/source\\_e.html](https://jp.sharp/business/lcd-display/support/download/source_e.html)

We are unable to answer any questions about the source code for the open source software. The source code for the software components whose copyrights are held by SHARP is not distributed.

# Mounting Precautions (For SHARP dealers and service engineers)

- When installing, removing or moving the monitor, ensure that this is carried out by at least 4 people.
- Be sure to use a wall-mount bracket designed or designated for mounting the monitor.
- This monitor is designed to be installed on a concrete wall or pillar. Reinforced work might be necessary for some materials such as plaster / thin plastic board / wood before starting installation.
- This monitor and bracket must be installed on a wall which can endure at least 4 times or more the weight of the monitor. Install by the most suitable method for the material and the structure.
- To attach a VESA-compliant mounting bracket, use M8 screws that are 3/8 inch (10 mm) to 1/2 inch (12 mm) longer than the thickness of the mounting bracket.

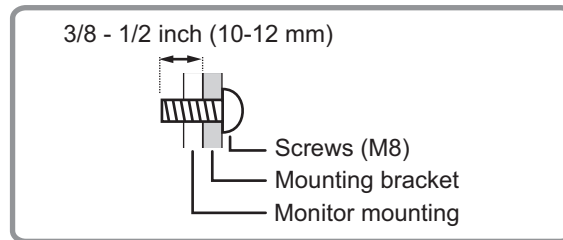

- Do not use an impact driver.
- When moving the monitor, be sure to hold the handles or the parts marked by  below. Do not grasp the screen or tray. This may cause product damage, failure, or injury.

[PN-C861H]

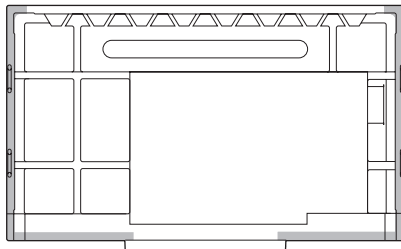

[PN-C751H]

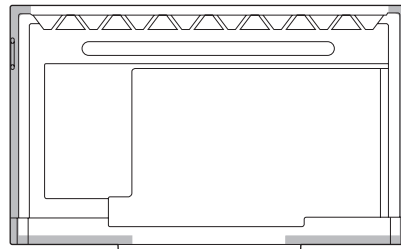

- If you need to temporarily place the monitor on a table or other surface during installation, spread a thick soft cloth on the table to prevent damage to the screen and table.
- Prior to repacking or removal, remove the tray.
- After mounting, please carefully ensure the monitor is secure, and not able to come loose from the wall or mount.
- Do not use any screw holes other than those for mounting brackets, located on the rear of the monitor, for installation.

## Mounting Precautions (For SHARP dealers and service engineers)

### ■Attaching the Tray

Secure the tray using 5 tray mounting screws (M3x15) (supplied).

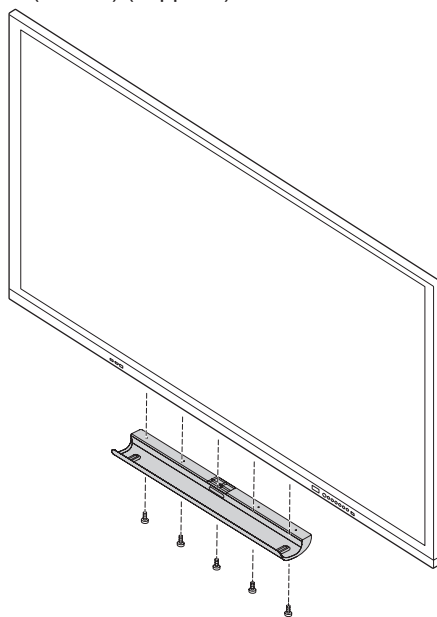

**SHARP**<sup>®</sup>  
SHARP CORPORATION