

# SK-Zone-6 Six Zone Interface Module

12 Clintonville Road, Northford, CT 06472  
203.484.7161; Fax: 203.484.7118  
www.silentknight.com

**SPECIFICATIONS**

Normal Operating Voltage:	15-32 VDC
Stand-By Current:	2 mA
Alarm Current:	40 mA (assumes all six LEDs solid on)
Temperature Range:	32°F to 120°F ( 0°C to 49°C)
Humidity:	10 to 93% Non-condensing
Dimensions:	6.8" H x 5.8" W x 1.0" D
Accessories:	IDP-ACB Cabinet and chassis
Wire Gauge:	12-18 AWG
Max. IDC Wiring Resistance:	25 ohms
External Power Supply Voltage:	Regulated 24VDC
Ripple Voltage:	0.1 volts RMS maximum
IDC:	(Supervised and power limited)
DC Voltage:	18-28 volts power limited
Frequency:	DC
Current:	90mA per circuit

**BEFORE INSTALLING**

If the modules will be installed in an existing operational system, inform the operator and local authority that the system will be temporarily out of service. Disconnect the power to the control panel before installing the modules. This system contains static sensitive components. Always ground yourself with a proper wrist strap before handling any circuits so that static charges are removed from the body. The module housing should also be grounded.

NOTICE: This manual should be left with the owner/user of this equipment.

**GENERAL DESCRIPTION**

The SK-Zone-6 Six Zone Interface Module is intended for use in an intelligent alarm system. Each module provides an interface between the intelligent alarm system and a conventional alarm system loop. A common SLC input is used for all modules, and the initiating device loops share a common supervisory supply and ground. Otherwise, each monitor operates independently from the others. Each module has its own unique address.

A pair of rotary code switches is used to set the address of the first module from 01 to 154. The remaining modules are automatically assigned to the next five higher addresses. Provisions are included for disabling a maximum of two unused modules to release the addresses to be used elsewhere. Each module also has panel controlled bicolor LED indicators. The panel can cause the LEDs to blink, latch on, or latch off.

**INCLUDED:**

- (5) 1 x 4 Terminal Blocks (2) 11/4" Stand offs (3) Shunts

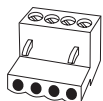

- (4) Machine Screws

- (1) Long Power Supply Jumper



- (2) Nuts



- (6) 3.9k Ohm

End of Line Resistors

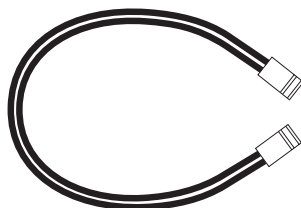

**COMPATIBLE TWO-WIRE SYSTEM SENSOR SMOKE DETECTORS FOR USE WITH SK-ZONE-6 WITH ZONE IDENTIFIER A**

DET. MODEL	COMP. ID	DETECTOR MANUFACTURER	BASE MODEL	MAX DET.
1151	A	SYSTEM SENSOR	B110LP, B401	20
1451	A	SYSTEM SENSOR	B401, B401B	20
1451DH	A	SYSTEM SENSOR	DH400	20
2151	A	SYSTEM SENSOR	B110LP, B401	20
2451	A	SYSTEM SENSOR	DH400, B401B, B401	20
2451TH	A	SYSTEM SENSOR	B401, B401B	20
5451	A	SYSTEM SENSOR	B401	20
1100	A	SYSTEM SENSOR	N/A	20
1400	A	SYSTEM SENSOR	N/A	20
**2100AT	A	SYSTEM SENSOR	N/A	20
2100B	A	SYSTEM SENSOR	N/A	20
2100D	A	SYSTEM SENSOR	N/A	20
2100S	A	SYSTEM SENSOR	N/A	20
2100TB	A	SYSTEM SENSOR	N/A	20
2100TD	A	SYSTEM SENSOR	N/A	20
2100TS	A	SYSTEM SENSOR	N/A	20
2300B	A	SYSTEM SENSOR	N/A	20
2300TB	A	SYSTEM SENSOR	N/A	20
2400	A	SYSTEM SENSOR	N/A	20
2400TH	A	SYSTEM SENSOR	N/A	20
*2W-B	A	SYSTEM SENSOR	N/A	20
*2W-TB	A	SYSTEM SENSOR	N/A	20
DH100LP	A	SYSTEM SENSOR	N/A	20

\*Class B, Style B only; \*\*No Accessory will be supported by 2100AT

**SHIPPED ON BOARD:**

- (2) Shunts in Class A/B position

(Shipped in Class B position, remove shunts for Class A)

**COMPATIBILITY REQUIREMENTS**

To ensure proper operation, this module shall be connected to a compatible Silent Knight system control panel (list available from Silent Knight).

**COMPONENTS**

The following is a description of the SK-Zone-6 mounting framework:

- One or two SK-Zone-6 modules can be installed in a IDP-ACB cabinet

**FIGURE 1: IDP-ACB CABINET**

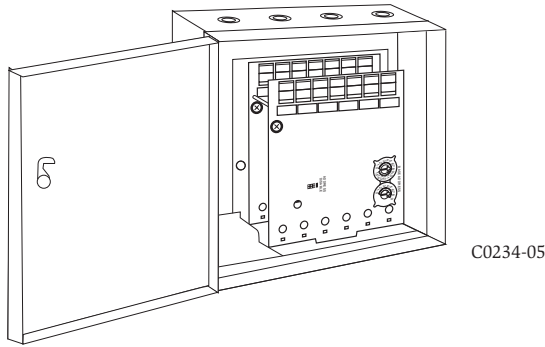

The IDP-ACB cabinet has a built-in chassis that will accommodate one or two SK-Zone-6 modules. For cabinet dimensions refer to the IDP-ACB instruction manual.

The front SK-Zone-6 module positions of each chassis are offset below the rear SK-Zone-6 module positions so that all of the status indicators are visible.

**INSTALLATION STEPS**

1. Cabinet Mounting

- In a clean, dry area, mount the backbox using the four holes provided in the back surface of the cabinet (Figure 2).

**FIGURE 2: TYPICAL MOUNTING HOLE LOCATIONS**

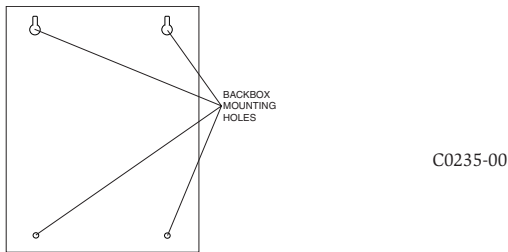

2. Module Installation

There are two methods for installing a module in the rear position of a chassis. Method one is for installation of a rear module only, when no module will be installed in front of it. Refer to Figure 3 for instructions. Method two is for installation of a rear module when another module will be installed in the chassis position in front of it. Refer to Figures 4a and 4b for method two. All necessary screws and standoffs are supplied with the modules.

**FIGURE 3: INSTALLATION OF REAR MODULE ONLY, METHOD ONE**

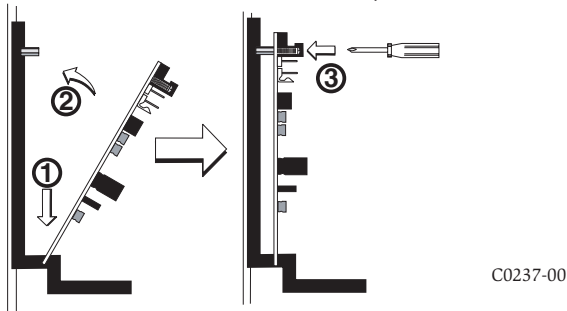

- Step 1: Insert the bottom of the SK-Zone-6 module down into a rear slot on the chassis.
- Step 2: Carefully swing the upper edge of the board back towards the back of the chassis until it touches the two standoffs.
- Step 3: Align two 4-40 screws with the two standoffs and tighten.
- Step 4: Address and wire the modules according to the instructions in this manual.

The steps in Figures 4a and 4b describe and illustrate module installation when the rear chassis position and the position in front of it will be filled. Front position installation is possible only if the rear position is filled with a module.

**FIGURE 4A: INSTALLATION OF SK-ZONE-6 MODULE IN A REAR CHASSIS POSITION, METHOD TWO**

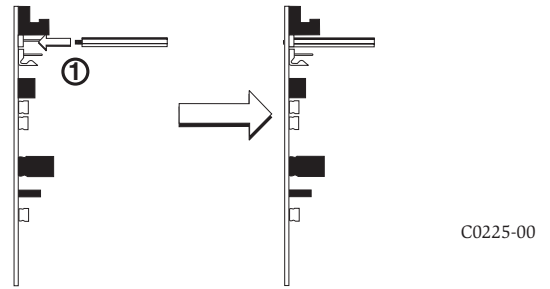

- Step 1: Insert the bottom edge of the SK-Zone-6 module down into a rear slot of the chassis.
- Step 2: Carefully swing the upper edge of the board towards the back of the chassis until it touches the short standoff attached to the chassis.
- Step 3: Align the long standoff with the short standoff and tighten.

**FIGURE 4B: INSTALLATION OF SK-ZONE-6 MODULE IN FRONT CHASSIS POSITION**

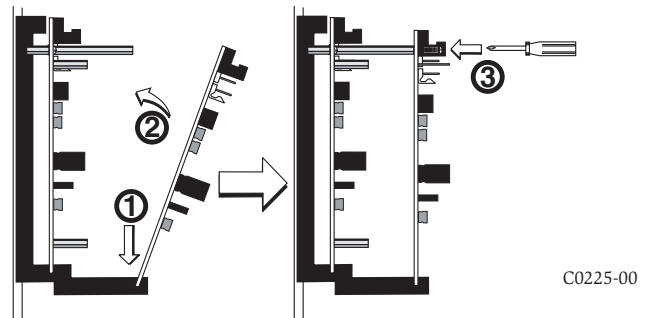

- Step 1: Insert the bottom edge of the SK-Zone-6 module down into a front slot of the chassis.
- Step 2: Carefully swing the upper edge of the board towards the back of the chassis until it touches the 11/4" (31.75mm) standoffs installed on the rear module.
- Step 3: Align two 4-40 screws with the two standoffs and tighten.
- Step 4: Address and wire the modules according to the instructions in this manual.

**WIRING**

NOTE: All wiring must conform to applicable local codes, ordinances, and regulations.

1. Install module wiring in accordance with the job drawings and appropriate wiring diagrams.
2. All wiring to the SK-Zone-6 is done via terminal blocks. In order to properly make electrical connections strip approximately 1/4" of insulation from the end of wire, sliding the bare end of the wire under the clamping plate screw.
3. Set the address on the modules per the job drawing. Use the rotary code switches to set the address of the first module between 01 and 154.

In Class B operation, the remaining modules are automatically assigned to the next five higher addresses. For example, if the base address switch is set to 28, the next five modules will be addressed to 29, 30, 31, 32 and 33.

The module is shipped in Class B position, remove shunts for Class A. When operating in Class A, alternate modules are paired together (+0/+1, +2/+3, +4/+5), resulting in a total of three modules. For example, if the base address switch is set to 28, then 30 and 32 will be automatically assigned to the modules while 29, 31 and 33 are available to be used for other modules on the SLC. For Class A and B operation, DO NOT set the lowest address above 154, as the other modules will be assigned to nonexistent addresses.

NOTE: The SK-Zone-6 must have power cycled for shunt changes to take effect.

4. A shunt is provided to disable a maximum of two unused modules in Class B operation and Class A operation. Modules are disabled from the highest address and work downward. If two modules are disabled, the lowest four addresses will be functional, while the highest two will be disabled. For example, in Class B operation, if the shunt for Address Disable is placed on "two" and the base switch is set to 28, the modules will be assigned to 28, 29, 30 and 31 while disabling the highest two positions.

NOTE: Place unused shunts on single pin to store on board for future use.

**WIRING NOTES**

- Power-limited circuits must employ type FPL, FPLR, or FPLP cable as required by Article 760 of the NEC.
- All wiring must be in accordance with the NEC, NFPA 72 and all other applicable codes and standards. All external power supplies must be power limited with battery back-up. All external power supplies and detectors must be UL listed for fire protection signaling applications.

**PROGRAMMING**

The modules are programmed as devices in each system according to the programming instructions in the appropriate FACP manual.

**FIGURE 5: INTERFACE TWO-WIRE CONVENTIONAL DETECTORS – CLASS B, STYLE B.**

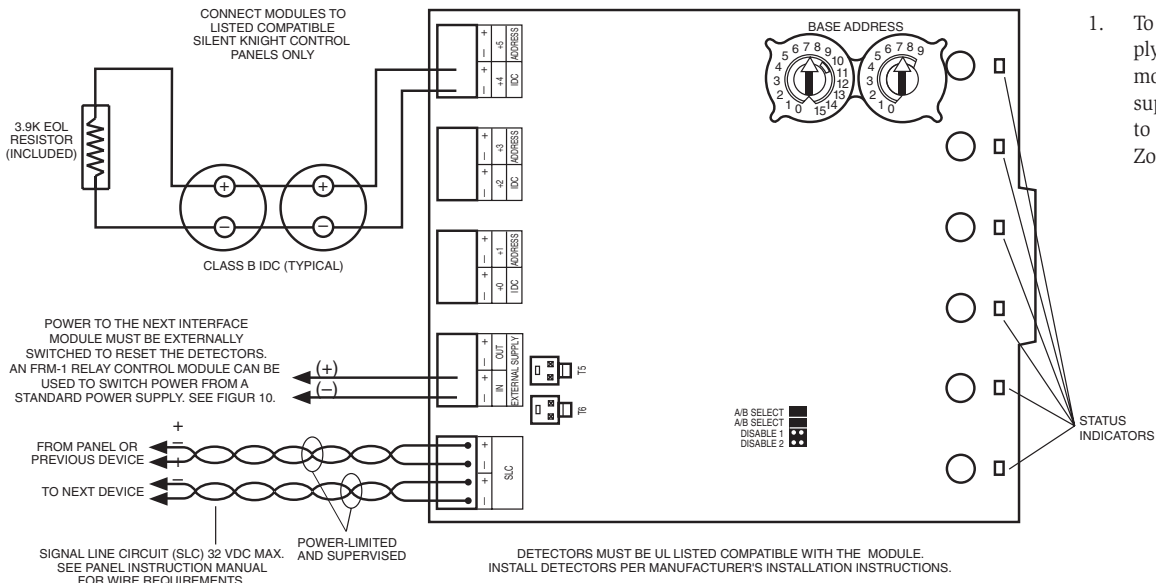

1. To use a common power supply between multiple SK-Zone-6 modules, connect a long power supply jumper from T5 or T6 to T5 or T6 on the adjacent SK-Zone-6 module.

C0812-01

**FIGURE 6: INTERFACE TWO-WIRE CONVENTIONAL DETECTORS – CLASS A, STYLE D.**

1. To select Class A, remove the two shunts from the "A/B select" positions.
2. To use a common power supply between multiple SK-Zone-6 modules, connect a long power supply jumper from T5 or T6 to T5 or T6 on the adjacent SK-Zone-6 module.

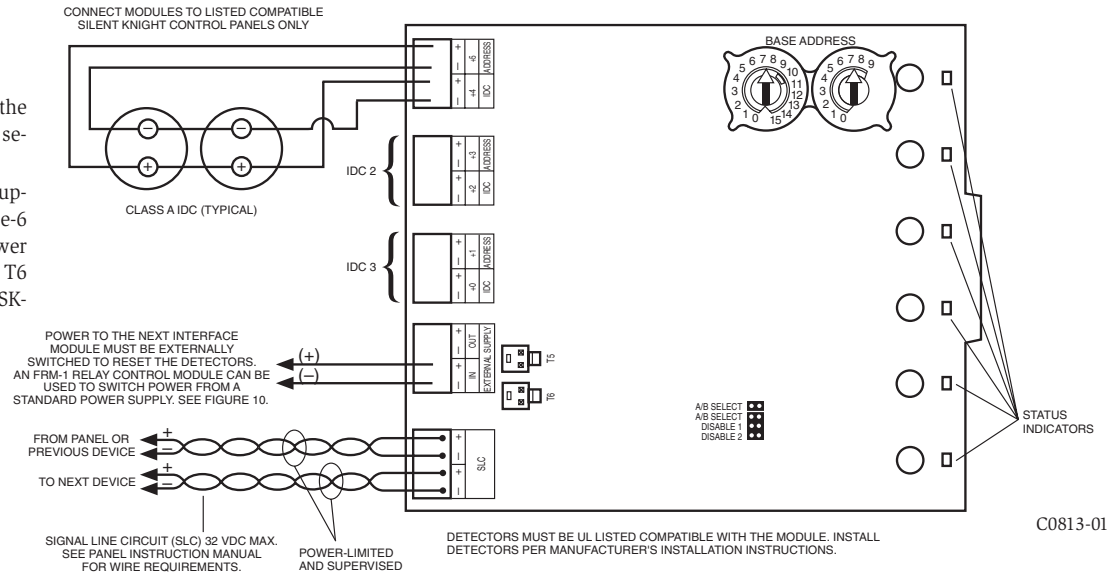

C0813-01

**FIGURE 7: RELAY CONTROL MODULE USED TO DISCONNECT A POWER SUPPLY.**

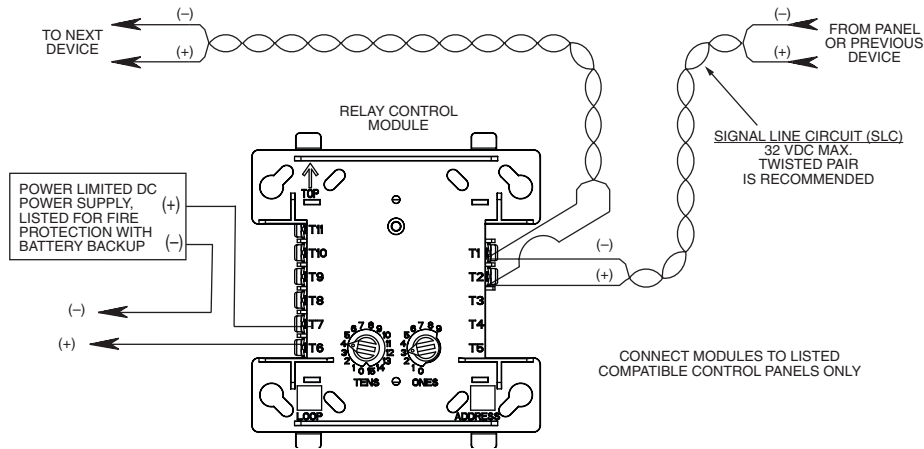

C0248-02

**FIGURE 8: EXAMPLE OF MULTIPLE BOARDS SHARING SAME EXTERNAL SUPPLY. REFER TO FIGURES 8 AND 9 FOR TYPICAL WIRING. MAKE CERTAIN LIP ON LONG POWER SUPPLY JUMPER ENGAGES RETAINING TAB ON T5 OR T6 AS SHOWN IN VIEW A-A.**

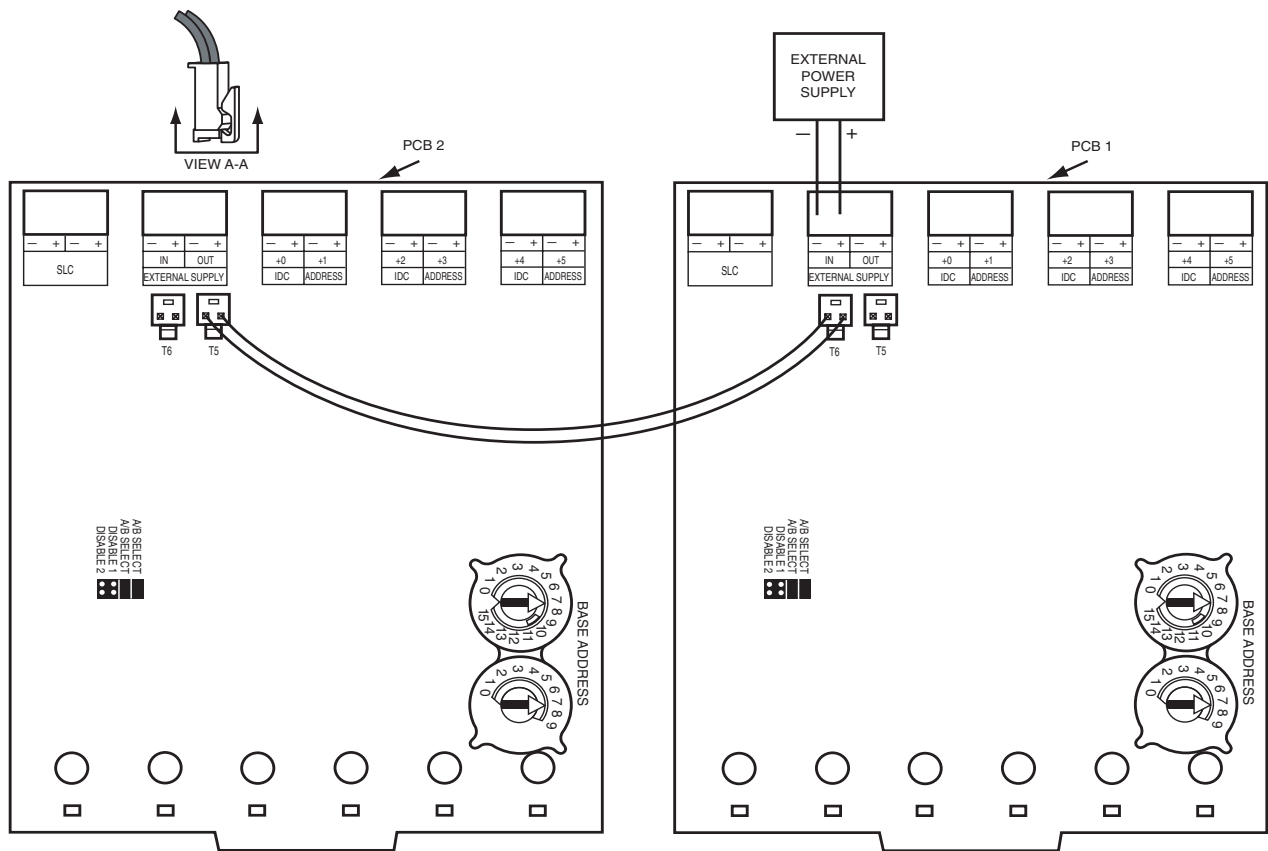

C0142-01

**FCC STATEMENT**

This device complies with part 15 of the FCC Rules. Operation is subject to the following two conditions: (1) This device may not cause harmful interference, and (2) this device must accept any interference received, including interference that may cause undesired operation.

NOTE: This equipment has been tested and found to comply with the limits for a Class B digital device, pursuant to Part 15 of the FCC Rules. These limits are designed to provide reasonable protection against harmful interference in a residential installation. This equipment generates, uses and can radiate radio frequency energy and, if not installed and used in accordance with the instructions, may cause harmful interference to radio communications. However, there is no guarantee that interference will not occur in a particular installation. If this equipment does cause harmful interference to radio or television reception, which can be determined by turning the equipment off and on, the user is encouraged to try to correct the interference by one or more of the following measures:

- Reorient or relocate the receiving antenna.
- Increase the separation between the equipment and receiver.
- Connect the equipment into an outlet on a circuit different from that to which the receiver is connected.
- Consult the dealer or an experienced radio/TV technician for help.