



TREND NETWORKS

SecuriTEST® IP





SecuriTEST® IP

Quick Reference Guide

Prise en main simplifiée

Kurzanleitung

Guía rápida de usuario

Breve Guida di Utilizzo

Guia de Referência Rápida

快速用户指南

171804. Rev.6 (10/2020)

TREND NETWORKS
Stokenchurch House
Oxford Road
Stokenchurch
High Wycombe
Buckinghamshire
HP14 3SX
UK
www.trend-networks.com

© TREND NETWORKS 2020

The information contained in this document is the property of TREND NETWORKS and is supplied without liability for errors and omissions. No part of this document may be reproduced or used except as authorized by contract or other written permission from TREND NETWORKS. The copyright and all restrictions on reproduction and use apply to all media in which this information may be placed. TREND NETWORKS pursues a policy of continual product improvement and reserves the right to alter without notice the specification, design, price or conditions of supply of any product or service. All rights reserved.

Les informations dans ce document sont la propriété de TREND NETWORKS et elles sont fournies sans responsabilité pour les erreurs et les omissions. Aucune partie de ce document ne doit être reproduite ou utilisée, sauf en cas d'autorisation par contrat ou en cas d'autre autorisation écrite donnée par TREND NETWORKS. Le copyright et toutes les limitations concernant la reproduction et l'utilisation s'appliquent à tous les supports sur lesquels cette information peut être placée. TREND NETWORKS améliore continuellement ses produits et se réserve le droit de modifier sans préavis la spécification, la conception, le prix ou les conditions de fourniture d'un produit ou d'un service. Tous droits réservés.

Die Informationen in diesem Dokument sind das Eigentum von TREND NETWORKS und werden ohne Gewährleistung der Vollständigkeit oder Korrektheit gegeben. Dieses Dokument darf nur soweit vertraglich oder anderweitig schriftlich von TREND NETWORKS. Zugesichert ganz oder teilweise vervielfältigt werden. Das Urheberrecht und alle Einschränkungen zur Vervielfältigung und Nutzung gelten für alle Datenträger, auf denen diese Informationen gespeichert werden können. TREND NETWORKS bemüht sich um ständige Produktverbesserungen und behält sich das Recht vor, die Spezifikation, das Design, den Preis oder die Lieferbedingungen jeglicher Produkte oder Dienste ohne Vorankündigung zu ändern. Alle Rechte vorbehalten.

Le informazioni contenute nel presente documento sono di proprietà di TREND NETWORKS e sono fornite senza alcuna responsabilità relativa a errori e omissioni. Sono vietati la riproduzione o l'uso di tutto il documento o parte di esso, salvo se autorizzati da contratto o permesso scritto di TREND NETWORKS Il copyright e tutte le limitazioni sulla riproduzione e l'uso si applicano a tutti i supporti nei quali le presenti informazioni possono essere contenute. TREND NETWORKS segue una politica volta al miglioramento continuo dei prodotti e si riserva il diritto di modificare senza preavviso le specifiche, il disegno, il prezzo o le condizioni di fornitura di qualsivoglia prodotto o servizio. Tutti i diritti riservati.

La información que figura en este documento es propiedad de TREND NETWORKS quien no asume responsabilidad alguna sobre posibles errores u omisiones que puedan existir en este documento. Queda prohibida la reproducción parcial o total de este documento, así como darle un uso distinto al autorizado mediante contrato o autorización escrita por parte de TREND NETWORKS independientemente del formato y soporte de los contenidos. TREND NETWORKS sigue una política de mejora continua del producto y nos reservamos el derecho de modificar sin previo aviso las especificaciones, diseño, precio o condiciones de suministro de cualquier producto o servicio. Todos los derechos reservados.

As informações contidas neste documento são de propriedade de TREND NETWORKS e são fornecidas sem responsabilidade sobre erros e omissões. Nenhuma porção deste documento pode ser reproduzida ou usada exceto quando autorizada mediante contrato ou outra permissão por escrito da TREND NETWORKS. Os direitos de cópia e restrições de reprodução e uso são aplicáveis a todas as mídias nas quais estas informações possam ser colocadas. A TREND NETWORKS segue uma política de melhora contínua do produto e se reserva ao direito de alterar sem aviso prévio as especificações, design, preço ou condições de fornecimento de qualquer produto ou serviço. Todos os Direitos Reservados.

本文件所包含的信息是理想工业网络公司(TREND NETWORKS) 的财产, 对于本文件中出现的错误或遗漏, 提供方概不负责。除非得到理想工业网络公司的合同授权或其他书面许可, 否则, 本文件的任何部分均不得复制或使。版权和对复制和使用的所有限制都适用于本信息发布的一切媒介。理想工业网络公司奉行持续改进产品的政策, 并保留在不事先通知的情况下变更任何产品或服务的规格、设计、价格或供货条件的权利。理想工业网络公司保留所有版权。

English

Français

Deutsch

Italiano

Español

Português

中文

Front Panel Controls

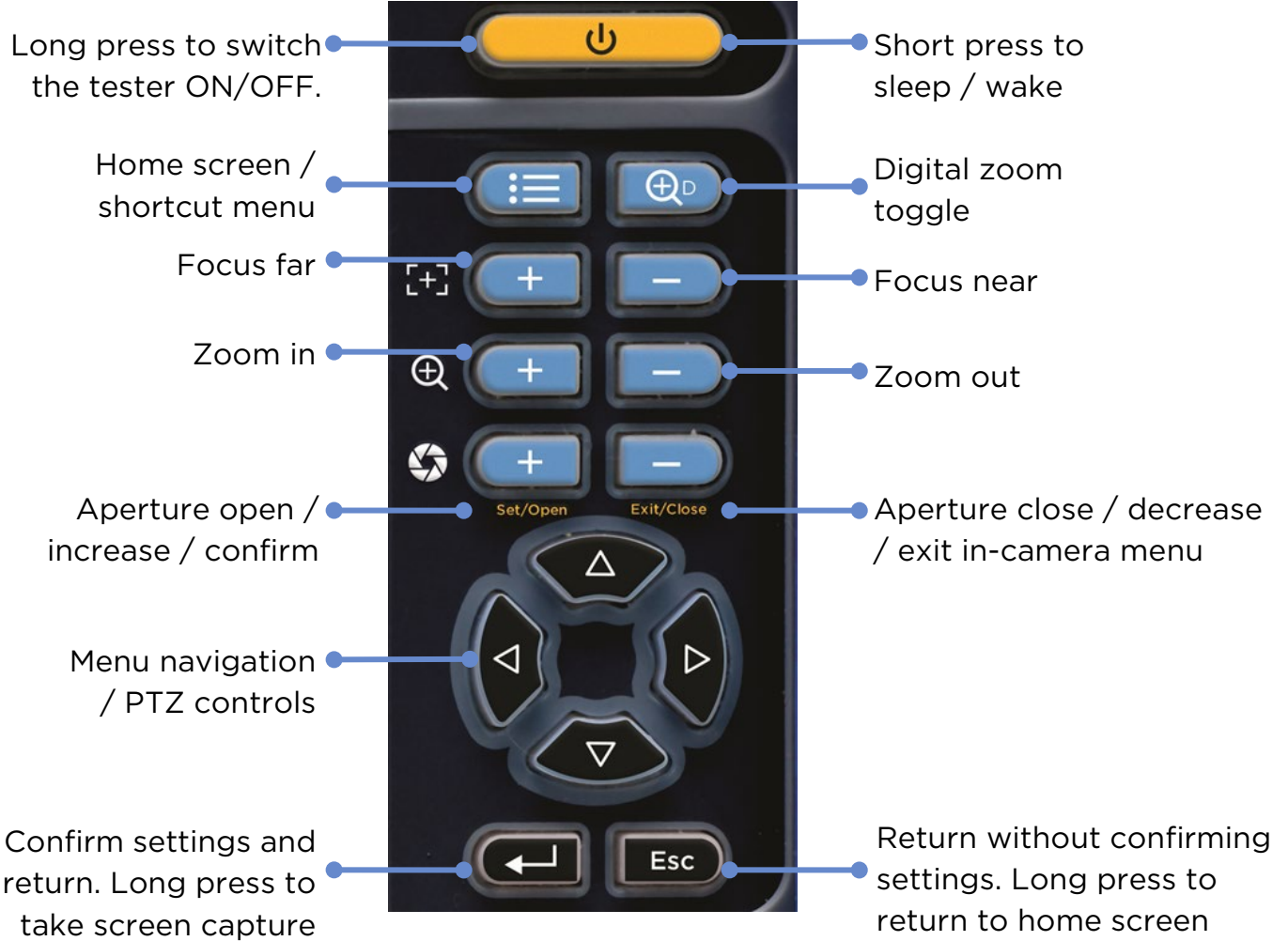

Front Panel Indicators

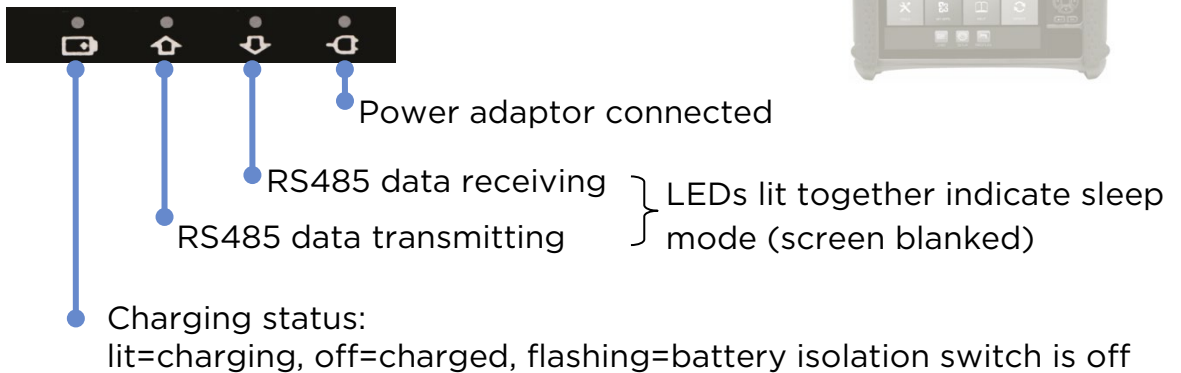

Top panel connectors and indicators

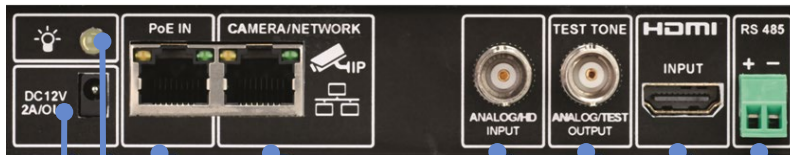

- LED flashlight
- 12 Volt / 2 Amp DC output to power non-PoE cameras
- Passes network PoE or PoE injector PoE to camera - does not pass data
- Direct connect to IP camera or LAN for access cameras on the network. Selectable PoE output.
- Coax video IN for analog, HD TVI/CVI/AHD
- Video OUT / Coax tone generator
- HDMI input for NVR/DVR checking (replacing display)
- RS485 PTZ interface

En

Bottom panel connectors and indicators



- Battery isolation / storage switch
- 12 Volt 2 Amp power adaptor input
- Audio IN and OUT
- USB 5V 2A charging port - no data connection
- UTP cable test port
- MicroSD card slot
- HDMI output for monitor testing

Display status bar



- Press application icon for help on the current screen.
- MicroSD card status
- Camera/Network port link status
- Battery status
- Time
- Press X to close screen.



IP CAMERA TESTING

Power Camera



Cameras can be powered from the 12 Volt / 2 Amp DC output or by Power over Ethernet (PoE).

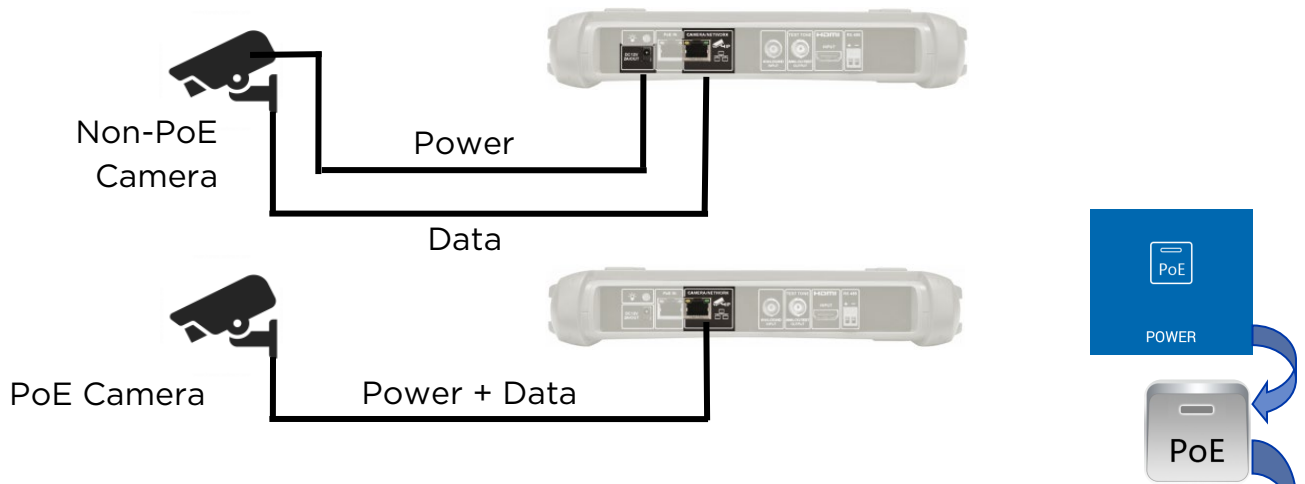

• Displays the setting of the power output

• Touch **PoE** switch to switch the PoE power on or off.

• Displays the PoE voltage, status and power drawn by the camera.



Quick IP Device Discovery

The IP Discovery tool provides facilities for discovering and testing a connected IP camera. A camera can be connected directly or via a network.

En

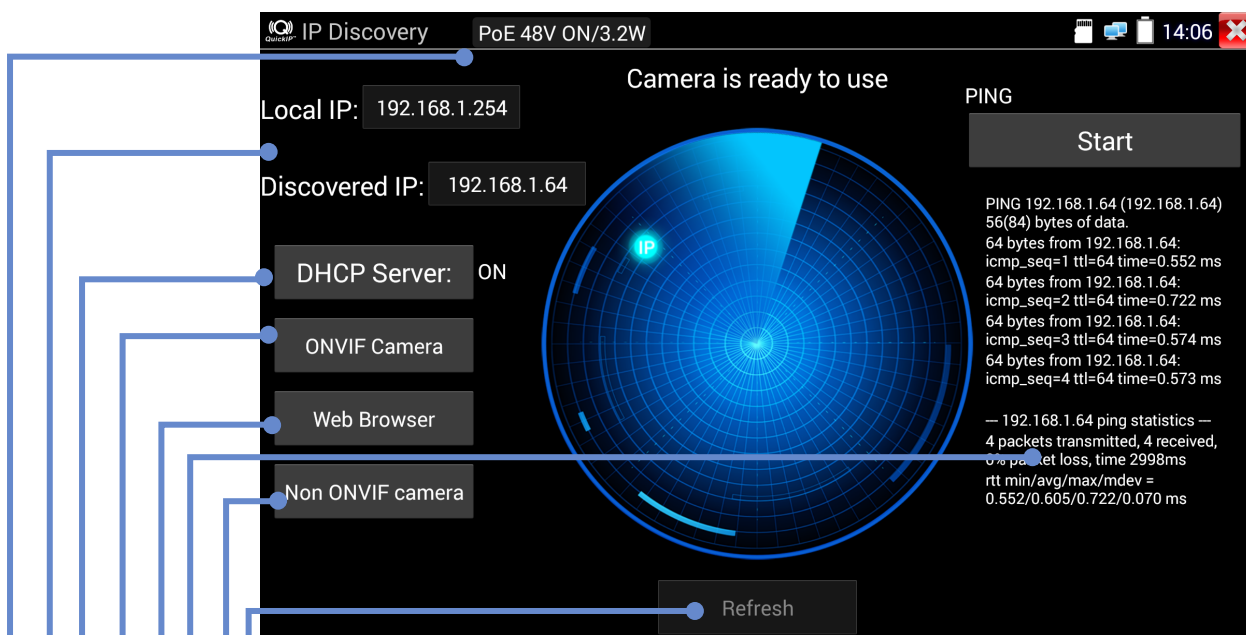

- Touch **REFRESH** to start the IP Discovery again following a timeout.
- Touch **NON-ONVIF CAMERA** to access the Non-ONVIF camera test function.
- Displays the results of the PING test. Touch **start** to PING the detected camera to verify network connection.
- Touch **WEB BROWSER** to access the camera
- Touch **ONVIF CAMERA** to connect to ONVIF-compliant cameras.
- Controls and indicates whether DHCP is enabled or OFF
- Displays the IP address of the tester and the discovered IP address of the connected camera
- Displays the PoE voltage, status and power drawn by the camera

ONVIF Camera Test



En

Cameras that are compliant with the standard methods of communication established by the Open Network Video Interface Forum (ONVIF) can be connected and tested without the need to make any manual adjustments to the connection details regardless of camera brand except user name and password.

● Touch an icon to display the camera setup menu, capture and play photos and videos, Pan/Tilt/Zoom, RTSP address, preview and create test reports. Touch and drag tool bar to display the "?" icon.

● Touch **ONVIF setting** to adjust the ONVIF settings

● Touch **Add** to add a new camera using its URL. Touch **Refresh** to update the Device List

● Displays the video stream from the connected camera. Double-tap to switch full-screen display on/off.

● Displays a list of available cameras. Touch a camera to connect to it.

● Displays the user name of the connected camera when logged in. When logged out, allows user name and password to be entered.

MENU TREES

Tests

En

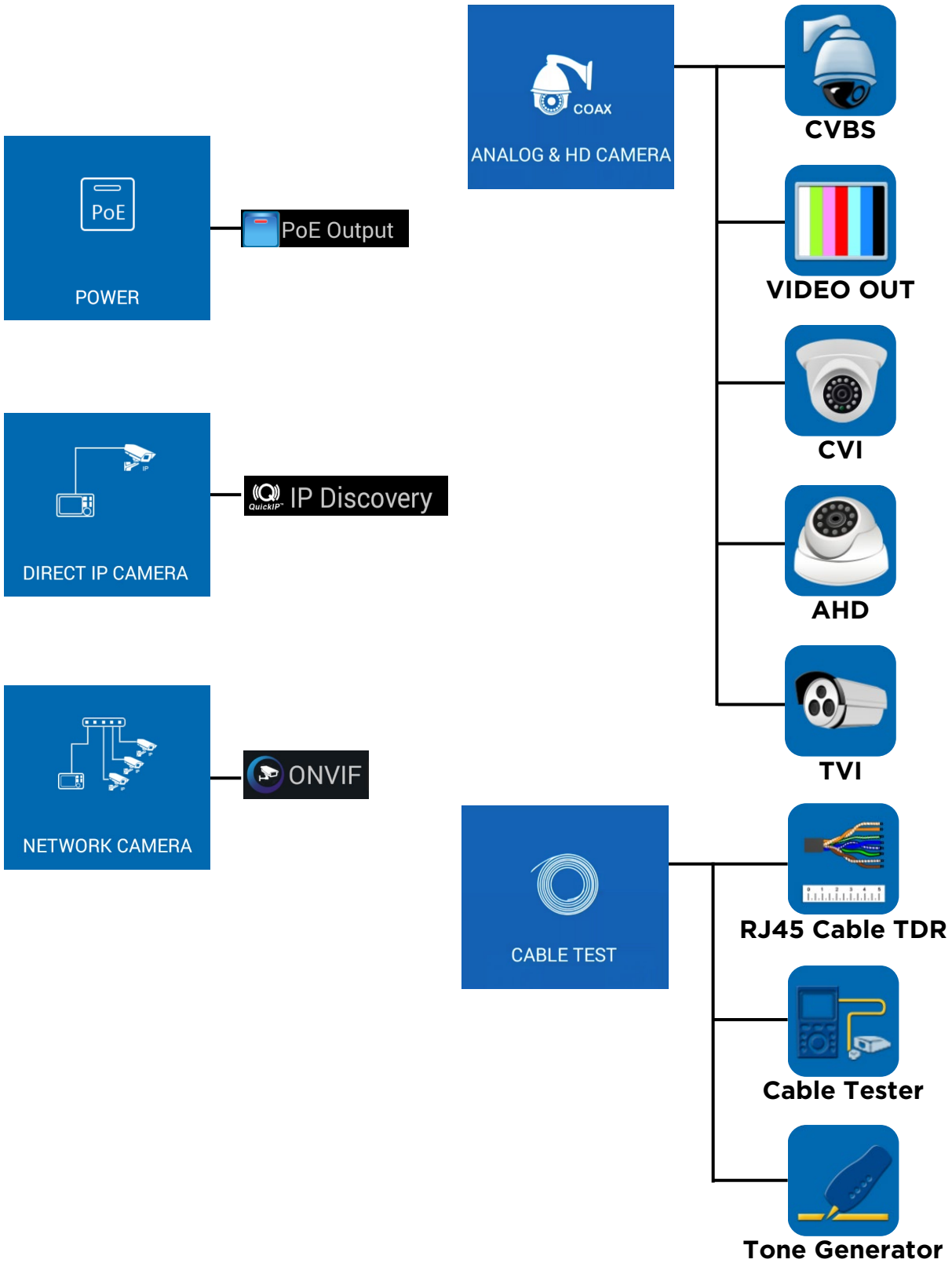

Tools and Apps

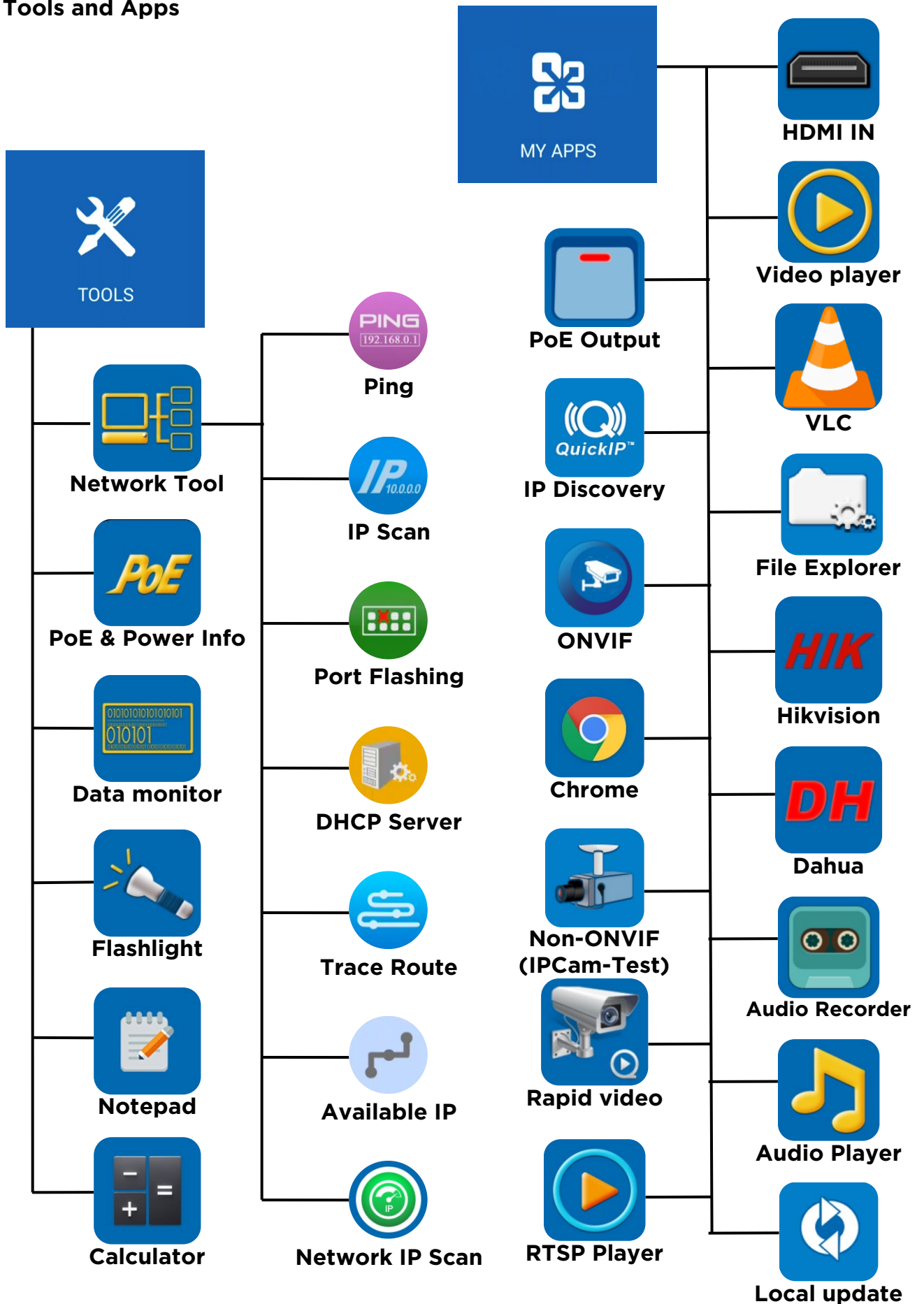

Setup & Others

En

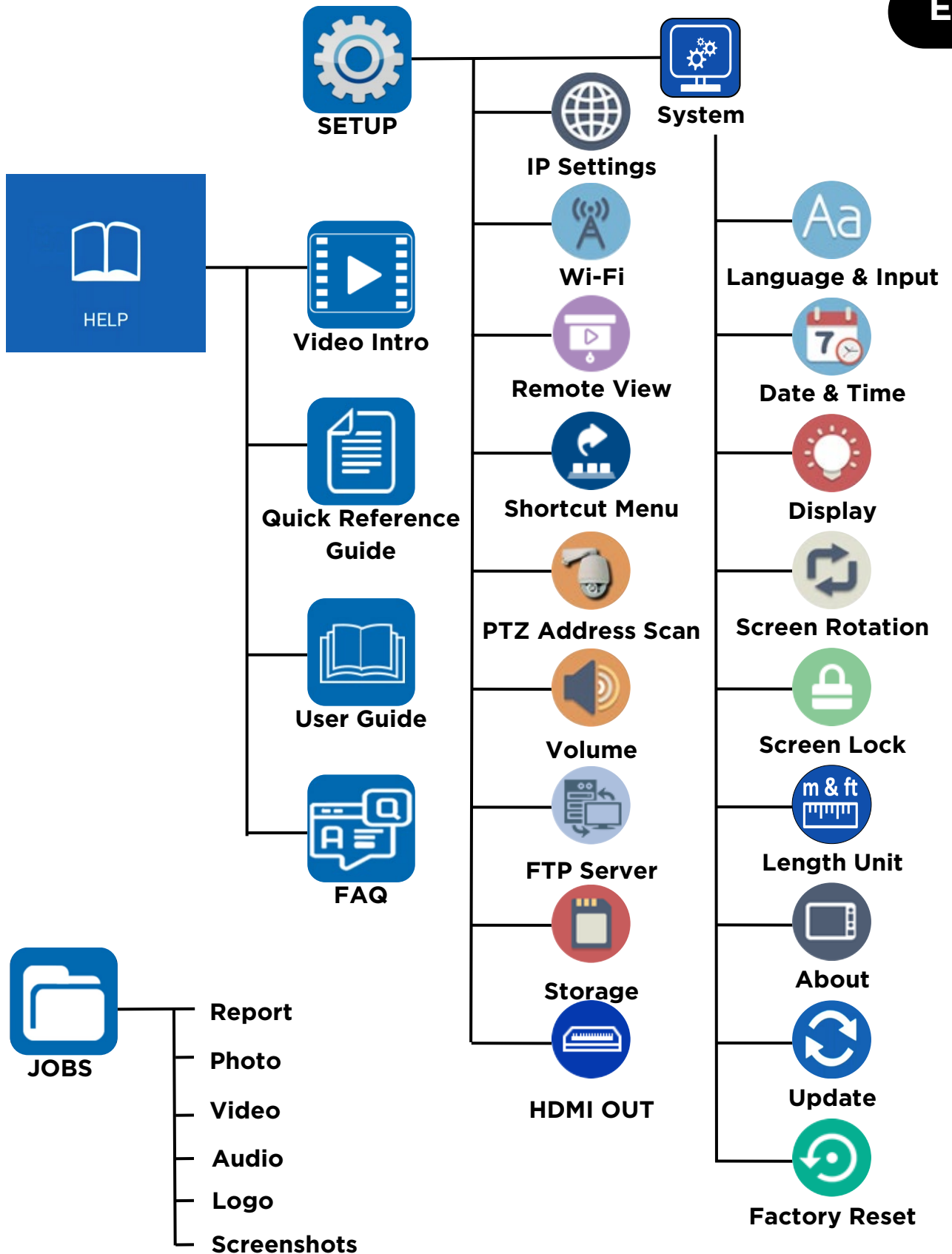

Commandes directes sur la face avant du testeur



Fr

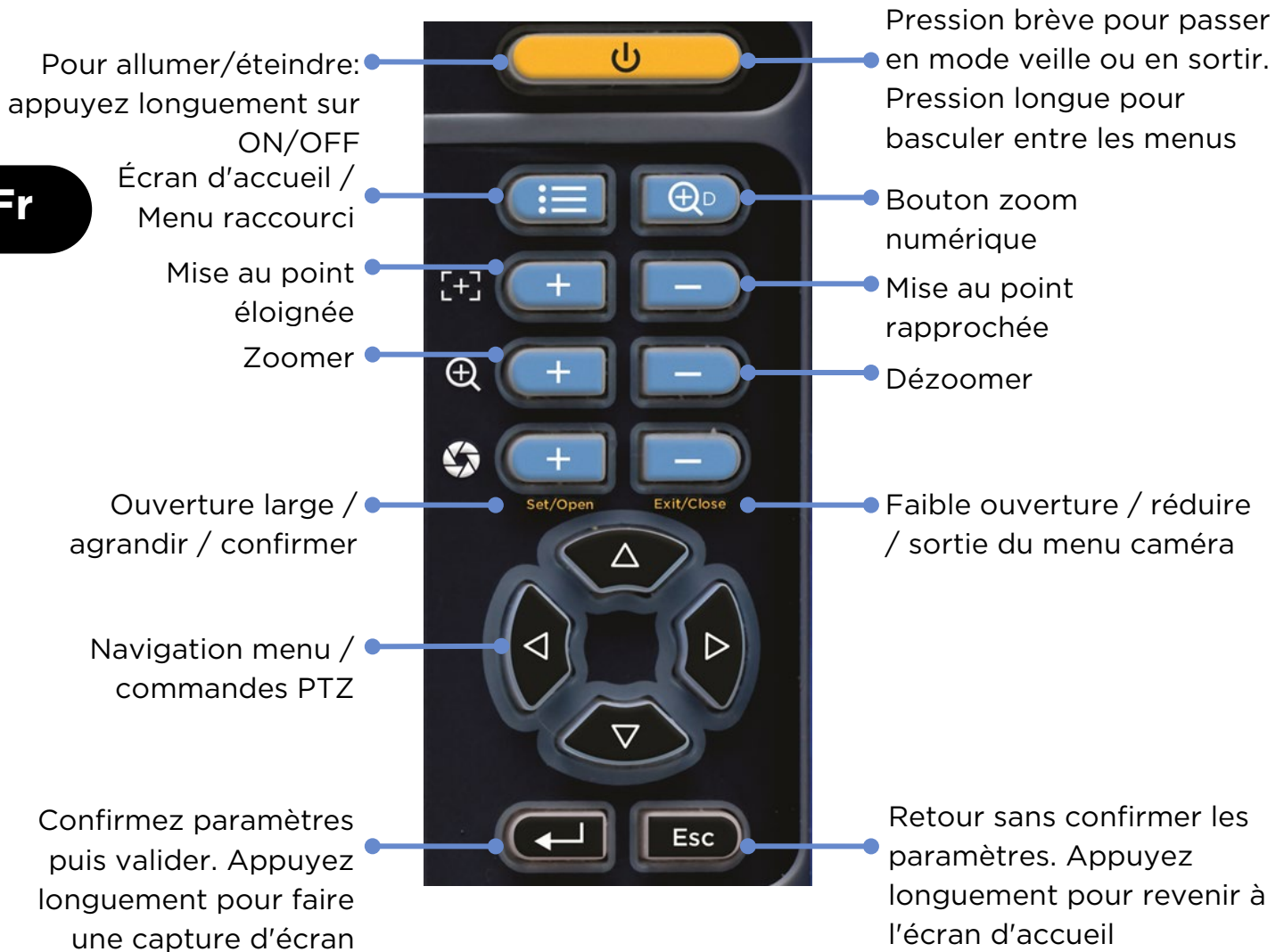

Indicateurs sur la face avant du testeur

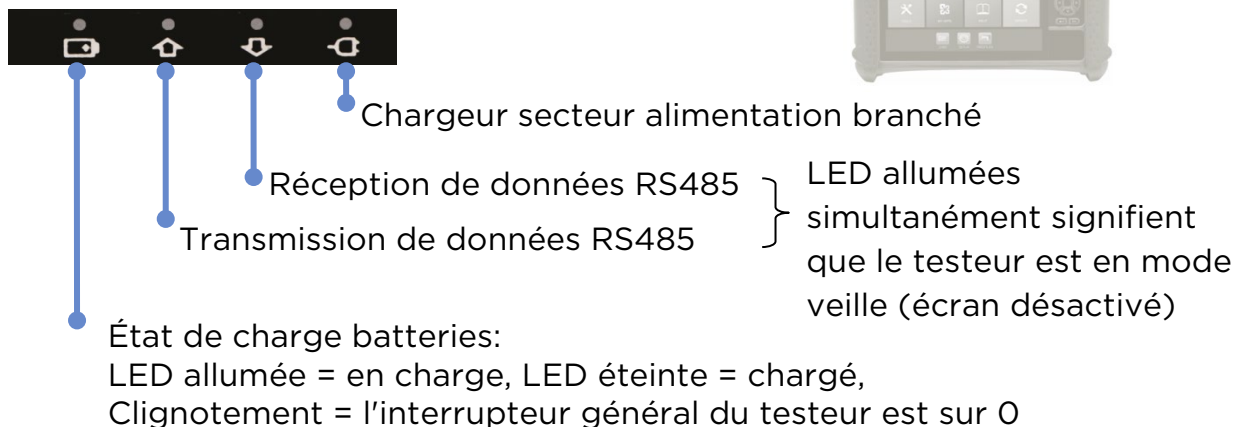

Connecteurs et indicateurs sur la partie supérieure



- Interface PTZ RS485
- Entrée HDMI pour vérification d'un DVR /NVR (remplace un moniteur externe)
- Sortie video BNC / Générateur de tonalité sur coaxial
- Entrée vidéo coaxiale BNC analogique HD TVI/CVI/AHD
- Branchement direct vers une caméra IP ou au réseau LAN pour accéder aux caméras présentes sur le réseau. La puissances PoE sera à définir.
- Transfert la PoE recue du réseau ou la PoE de l'injecteur PoE vers une caméra - ne transmet pas de données
- Lumière lampe torche LED
- Sortie 12V - 2A DC pour alimenter des caméras non-PoE

Fr

Commandes et connecteurs sur la partie inférieure



- Sortie HDMI pour envoyer l'image vers un moniteur
- Fente pour carte MicroSD
- Entrée RJ45 pour tests de câbles
- Port de charge USB 5V 2A - Pas de transfert de données
- Sortie et entrée audio
- Entrée alimentation testeur en 12V - 2A
- Interrupteur general 0/I

Affichage barre d'état en haut de l'écran



- Appuyez sur l'icône de l'application pour obtenir de l'aide qui sera affichée sur l'écran en cours
- Appuyez sur X pour fermer l'écran.
- Heure
- État de la batterie
- État du port réseau/caméra
- État de la carte MicroSD

TEST DE CAMÉRA IP

Alimentater la caméra

MISE SOUS TENSION

DECOUVERTE DES CAMÉRAS IP

ACCÈS CAMÉRA

PARAMÈTRES CAMÉRA

RAPPORT / CAPTURE ÉCRAN

Les caméras peuvent être alimentées grâce à la sortie 12V / 2A DC du testeur - ou en PoE par le réseau

Fr

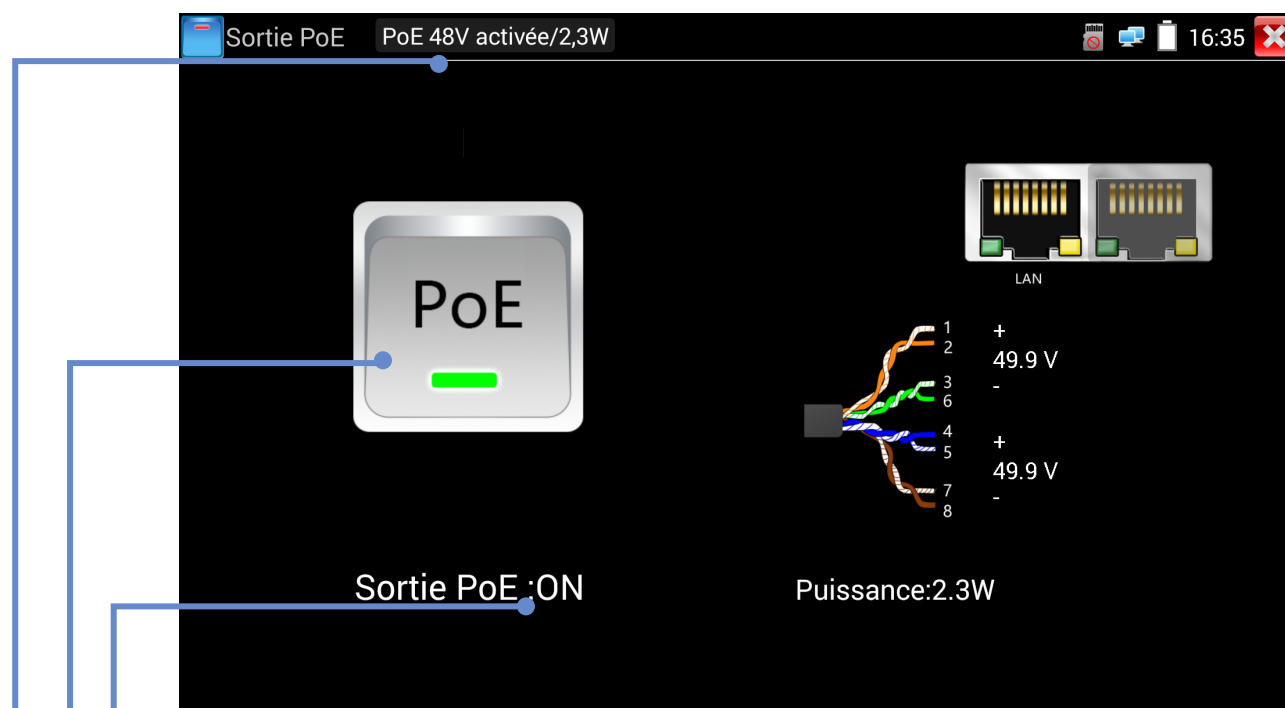
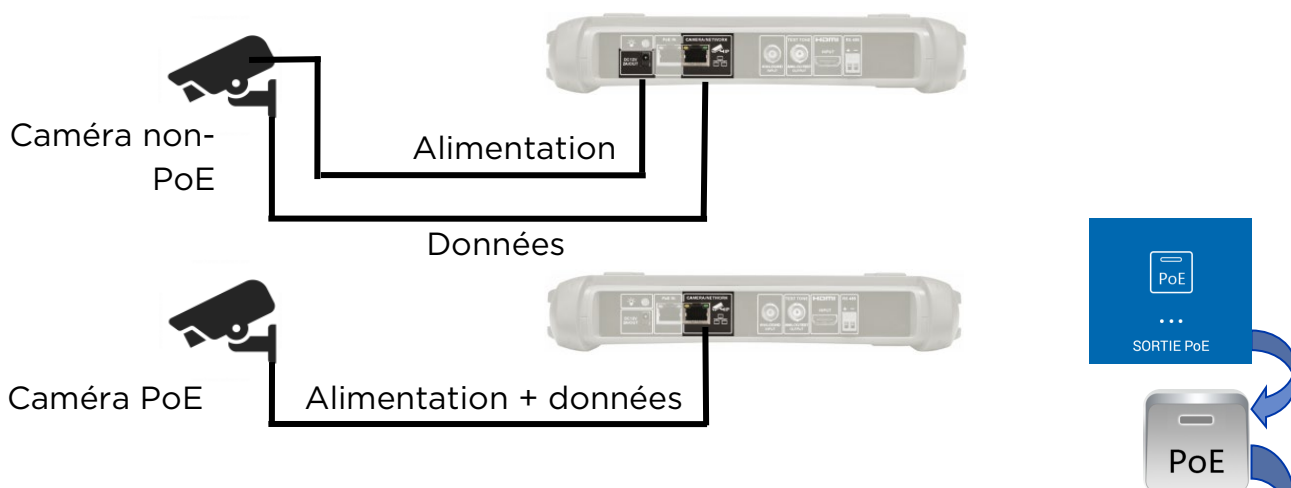

● Affiche les paramètres de la puissance de sortie PoE

● Appuyez sur le **OFF** de l'interrupteur pour désactiver la sortie PoE. Appuyez sur **ON** pour la mettre en fonctionnement.

● Affiche la tension PoE, l'état et la consommation énergétique de la caméra.

Découverte rapide des équipements IP



L'outil de Découverte IP permet de trouver et de tester facilement une caméra IP installée; elle peut être directement reliée au testeur ou raccordée au réseau local.



Fr



- Appuyez sur **RAFRAICHIR** pour relancer la découverte IP - après une pause.
- Appuyez sur **CAMÉRA NON-ONVIF** pour accéder à la fonctionnalité de tests IPCam.
- Affiche les résultats du test PING. Appuyez sur Démarrer pour lancer le test PING sur la caméra détectée et vérifier sa connexion
- Appuyez sur **NAVIGATEUR INTERNET** pour accéder à la caméra
- Appuyez sur **CAMÉRA ONVIF** pour vous connecter à des caméras compatibles ONVIF.
- Vérifie et indique si le DHCP est activé ou non
- Affiche l'adresse IP du testeur et celle de la caméra détectée
- Affiche la tension PoE, l'état et la consommation énergétique de la caméra.

Test de la caméra ONVIF



Les caméras compatibles ONVIF (Open Network Video Interface Forum) - qui est un standard de communications pour les caméras IP- peuvent être branchées et testées sans avoir recours à des réglages manuels de connexion, et peu importe la marque de la caméra IP - restent bien entendu le nom d'utilisateur et le mot de passe à définir.

Fr

The screenshot shows the ONVIF web interface. At the top, it displays 'ONVIF PoE 48V activée/3,2W Courant principal 1920x1080 h264' and the time '15:49'. Below this, there's a 'connecté :admin' status and a 'Déconnect' button. A 'Liste appareils(1)' section lists a HIKVISION camera with details like 'Numéro de caméra 1' and '192.168.1.64'. The main area shows a live video feed of a store aisle with a timestamp '03-08-2017 Wed 20:37:55'. At the bottom, there are buttons for 'Ajouter', 'Rafraic.', 'Config. ONVIF', 'menu', 'PTZ', 'RTSP', and 'doc'. A 'Cam ONVIF' label is positioned above the interface.

- Appuyez sur une icône pour afficher les paramètres de la caméra, capturer et lancer des photos et vidéos, utiliser la fonction PTZ (faire un panoramique/incliner/zoomer), obtenir une adresse RTSP, voir et créer des rapports de test. Appuyez et glissez votre doigt sur la barre d'icônes pour aller sur celle du "?"
- Appuyez sur **Config. ONVIF** pour régler les paramètres ONVIF
- Appuyez sur **Ajouter** pour ajouter une nouvelle caméra en utilisant son URL. Appuyez sur Rafraîchir pour mettre à jour la liste des équipements
- Affiche le flux vidéo depuis la caméra connectée. Appuyez deux fois pour passer en mode plein écran ou en sortir.
- Affiche la liste des caméras détectées. Appuyez sur l'une d'elle pour s'y connecter.
- Lorsque la caméra est connectée, son nom d'utilisateur s'affiche. Une fois débranchée, l'appareil permet d'entrer un nom d'utilisateur et un mot de passe

Arborescences des menus

Tests

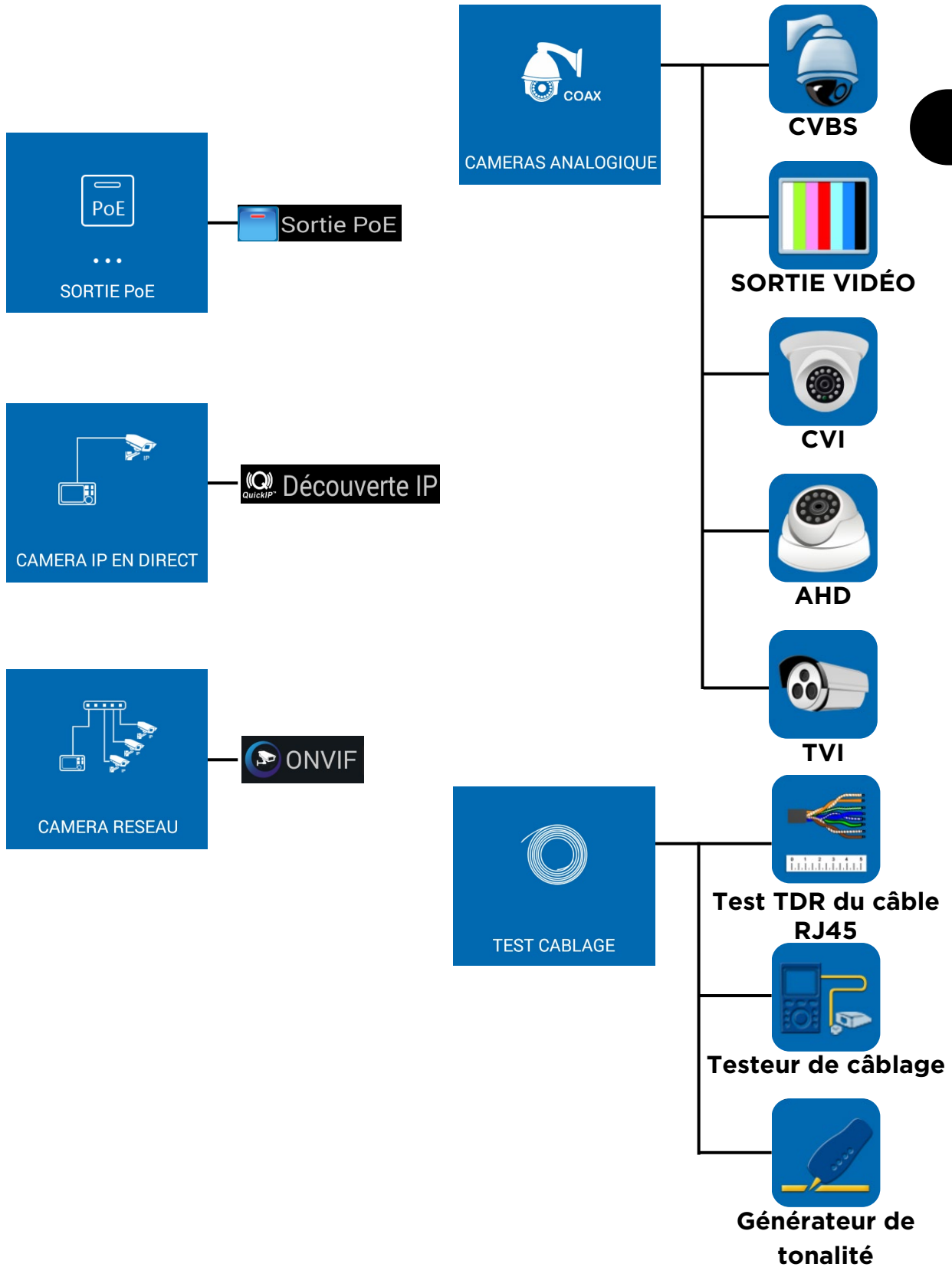

Outils et Applications

Fr

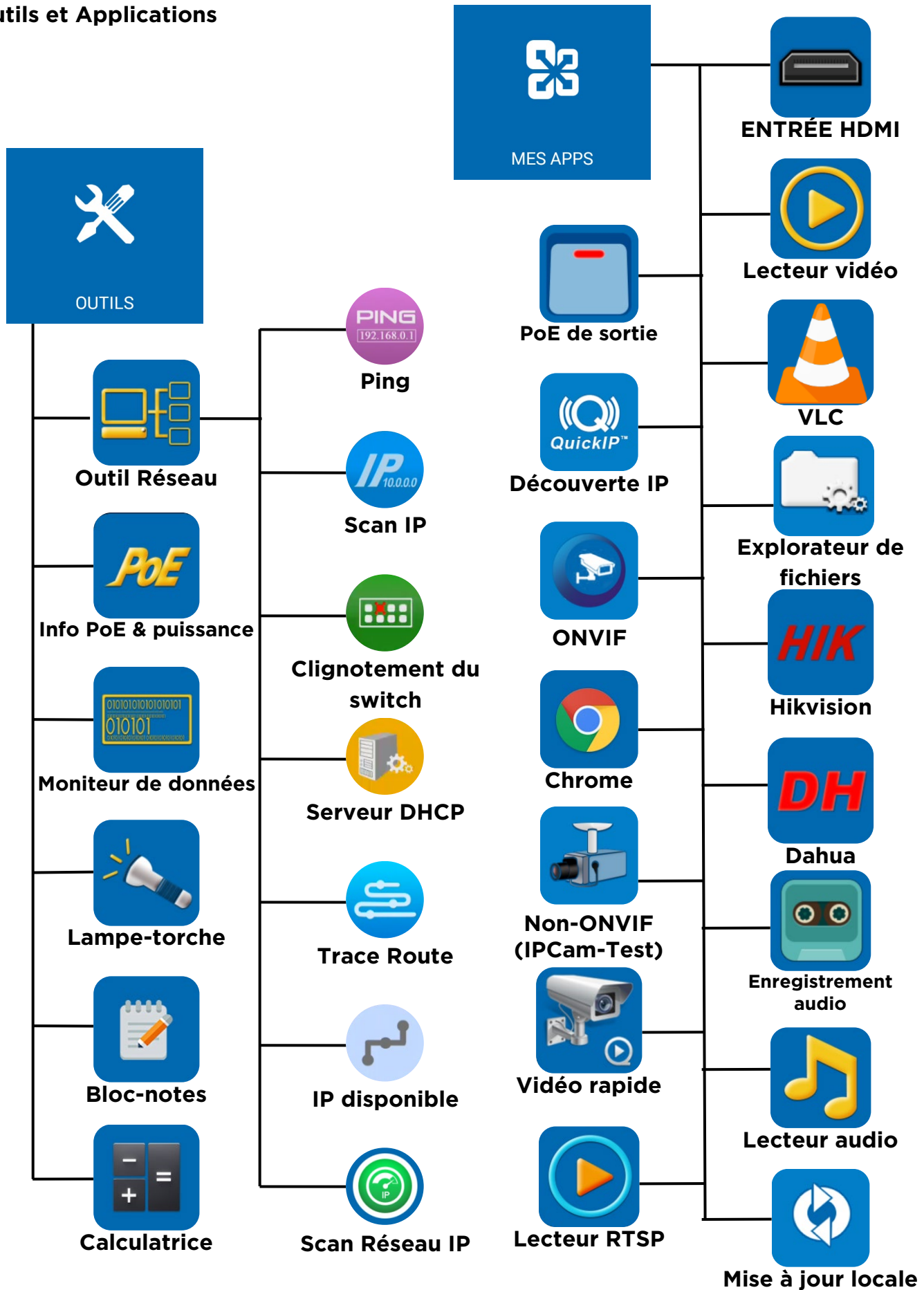

Configurations & Autre

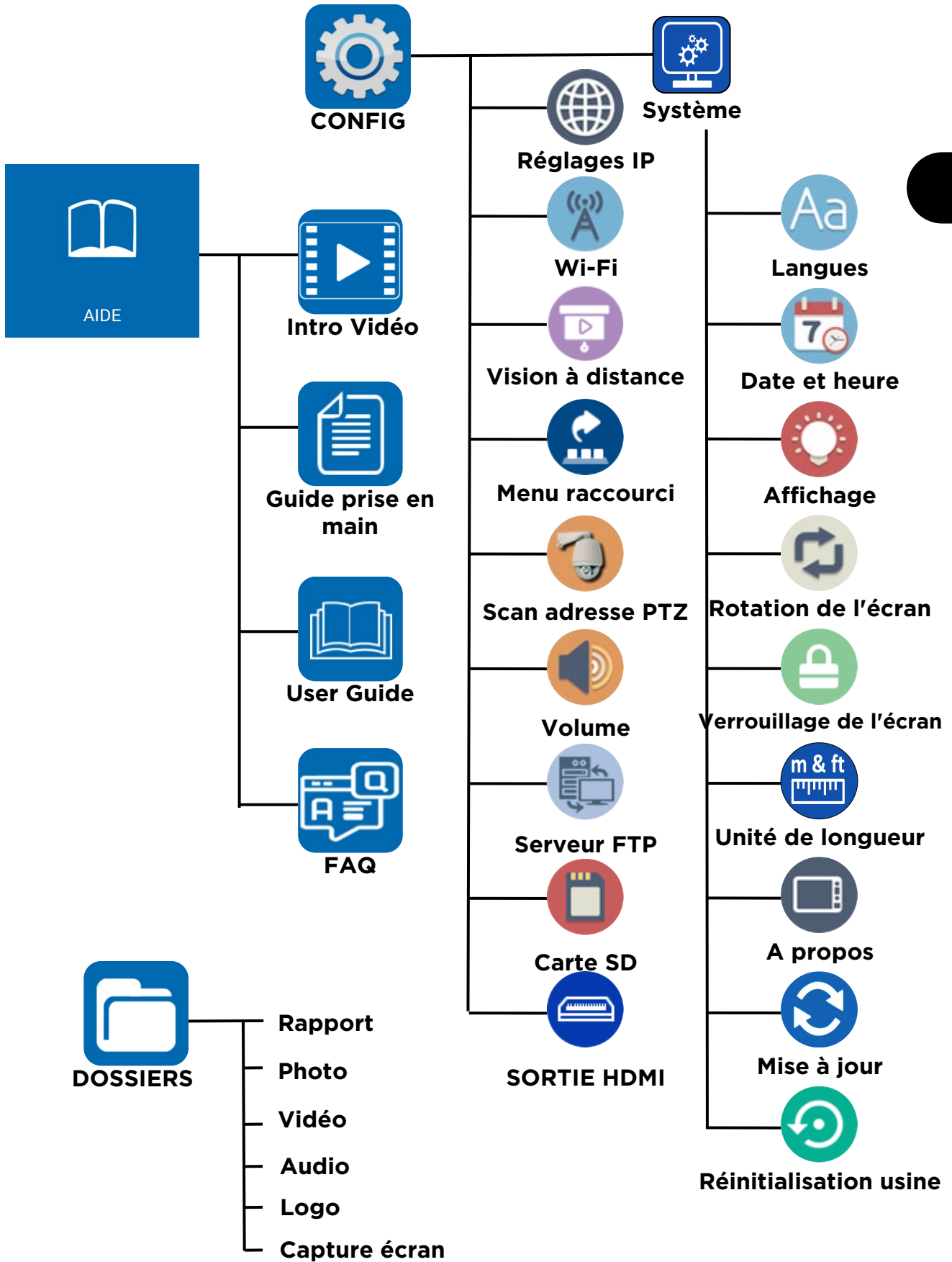

Fr

Bedienelemente auf der Vorderseite



Anzeigen auf der Vorderseite

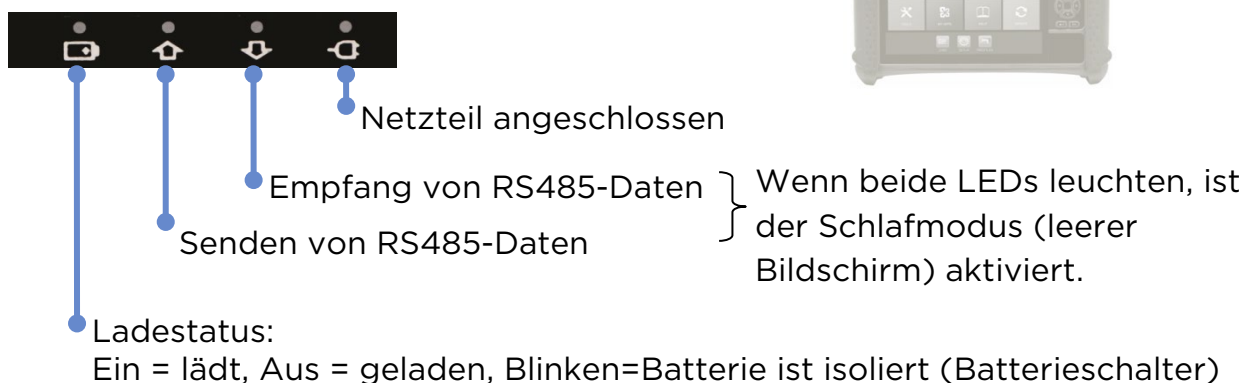

Anschlüsse und Anzeigen auf der Oberseite

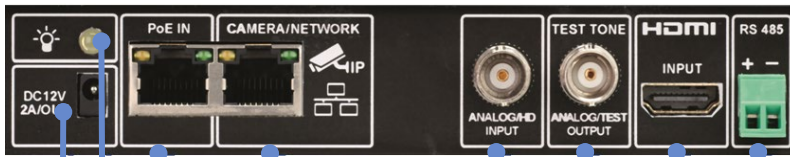

- PTZ-Schnittstelle (RS485)
- HDMI-Eingang für NVR/DVR-Prüfung (ersetzt Bildschirm)
- Video-Ausgang / Tongenerator (Koax)
- Video-Eingang (Koax) für analog, HD TVI/CVI/AHD
- Direktanschluss an IP-Kamera oder LAN zum Zugriff auf Kameras über das Netzwerk. Auswählbarer PoE-Ausgang.
- Weiterleitung von PoE / PoE-Injektor an die Kamera. Keine Datenübertragung.
- LED-Blinklicht
- 12 V / 2 A DC-Ausgang zur Stromversorgung von Kameras ohne PoE

De

Anschlüsse und Bedienelemente an der Unterseite



- HDMI-Ausgang für Monitor-Test
- Slot für Micro-SD-Karte
- UTP-Kabeltest
- USB-Ladebuchse, 5 V, 2 A - kein Datenanschluss
- Audio-Eingang und -Ausgang
- Netzteil-Eingang, 12 V, 2 A
- Hauptschalter

Status-Leiste



- Anwendungssymbol drücken, um Hilfe zur aktuellen Bildschirmanzeige zu erhalten.
- Status der Micro-SD-Karte
- Status der Netzwerkverbindung
- Akku-Status
- Uhrzeit
- Bildschirm durch Drücken von X schließen.

TESTEN DER IP-KAMERA

Kamera einschalten

EINSCHALTEN

ERKENNUNG
DER IP-
ADRESSE

ZUGRIFF
AUF
KAMERA

KAMERA-
EINRICHTUNG

BERICHT /
SCREENSHOT

Die Kameras können über den DC-Ausgang (12 V/2 A) oder über PoE versorgt werden.

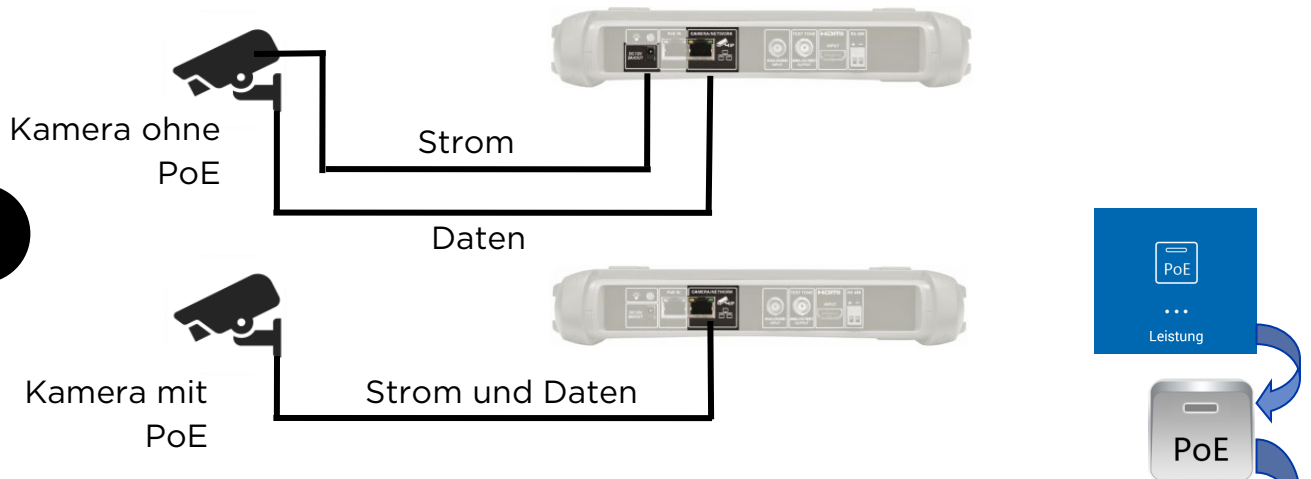

De

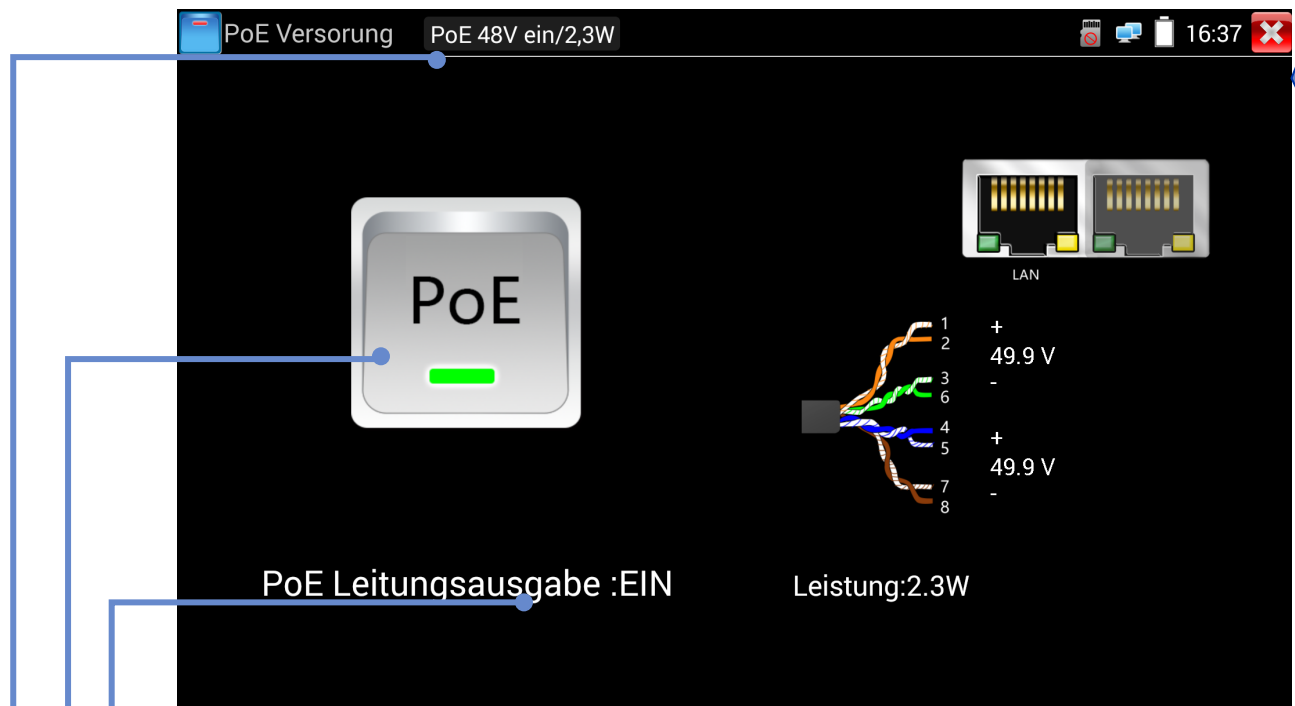

Anzeige Status des PoE Ausgangs

Mit **AUS** die PoE Versorgung ausschalten. Mit **EIN** die PoE Versorgung einschalten.

Anzeige von PoE-Spannung, Status und Leistungsaufnahme der Kamera.

Schnelle Erkennung von IP-Geräten



Die Funktion IP-Erkennung findet eine angeschlossene IP-Kamera, die dann getestet werden kann. Dabei kann die Kamera direkt oder über ein bestehendes Netzwerk angeschlossen sein.

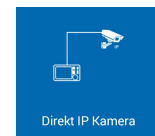

- Über die Schaltfläche **AKTUALISIEREN** wird die IP-Erkennung erneut gestartet.
- Über die Schaltfläche **NON-ONVIF KAMERA** wird der Test ohne ONVIF Unterstützung .
- Anzeige der Ergebnisse des **PING**-Tests. Über die Schaltfläche **Start** wird der **PING-Test** für die erkannte Kamera gestartet, um die Erreichbarkeit zu prüfen.
- Über die Schaltfläche **WEB-BROWSER** erhalten Sie Zugriff auf die Weboberfläche der Kamera.
- Über **ONVIF-KAMERA** wird eine Verbindung zur Kamera über das ONVIF-Protokoll aufgebaut.
- Konfiguriert und ändert den Status des **DHCP-Servers**. Mit on/off wird der Zustand angezeigt.
- Anzeige der IP-Adresse des Testers und der erkannten IP-Adresse der angeschlossenen Kamera.
- Anzeige von PoE-Spannung, Status und Leistungsaufnahme der Kamera.

Testen von ONVIF-Kameras



Kameras, die die Standardkommunikation nach den Methoden unterstützen, die das Open Network Video Interface Forum (ONVIF) festgelegt hat, können ohne weitere manuelle Einstellungen und unabhängig vom Hersteller angeschlossen und getestet werden.

De

- Anzeige des Benutzernamens der angeschlossenen Kamera, wenn angemeldet. Wenn nicht angemeldet, können dort der Benutzername und das Passwort eingegeben werden.
- Anzeige des Videostroms der angeschlossenen Kamera. Zweimal kurz hintereinander antippen, um die Vollbildanzeige ein-/auszuschalten.
- Anzeige einer Liste der verfügbaren Kameras. Zum Verbinden, Kamera antippen.
- Über die Schaltfläche **Hinzu** können Sie eine neue Kamera über deren URL-Adresse hinzufügen. Über die Schaltfläche **Aktualisieren** können Sie die **Geräteliste** aktualisieren.
- Über die Schaltfläche **Einstellung** können Sie die ONVIF-Einstellungen bearbeiten.
- Durch Berühren der betreffenden Symbol-Schaltflächen können Sie das Setup-Menü der Kamera öffnen, Fotos machen und Videos aufzeichnen sowie abspielen, die Kamera schwenken, neigen und zoomen (PTZ), Echtzeit-Streaming (RTSP) und eine Vorschau starten und Testberichte (doc) erstellen. Zur Anzeige des Hilfemenüs („?“) ziehen Sie die Symbolleiste zur Seite.

MENÜSTRUKTUR

Tests

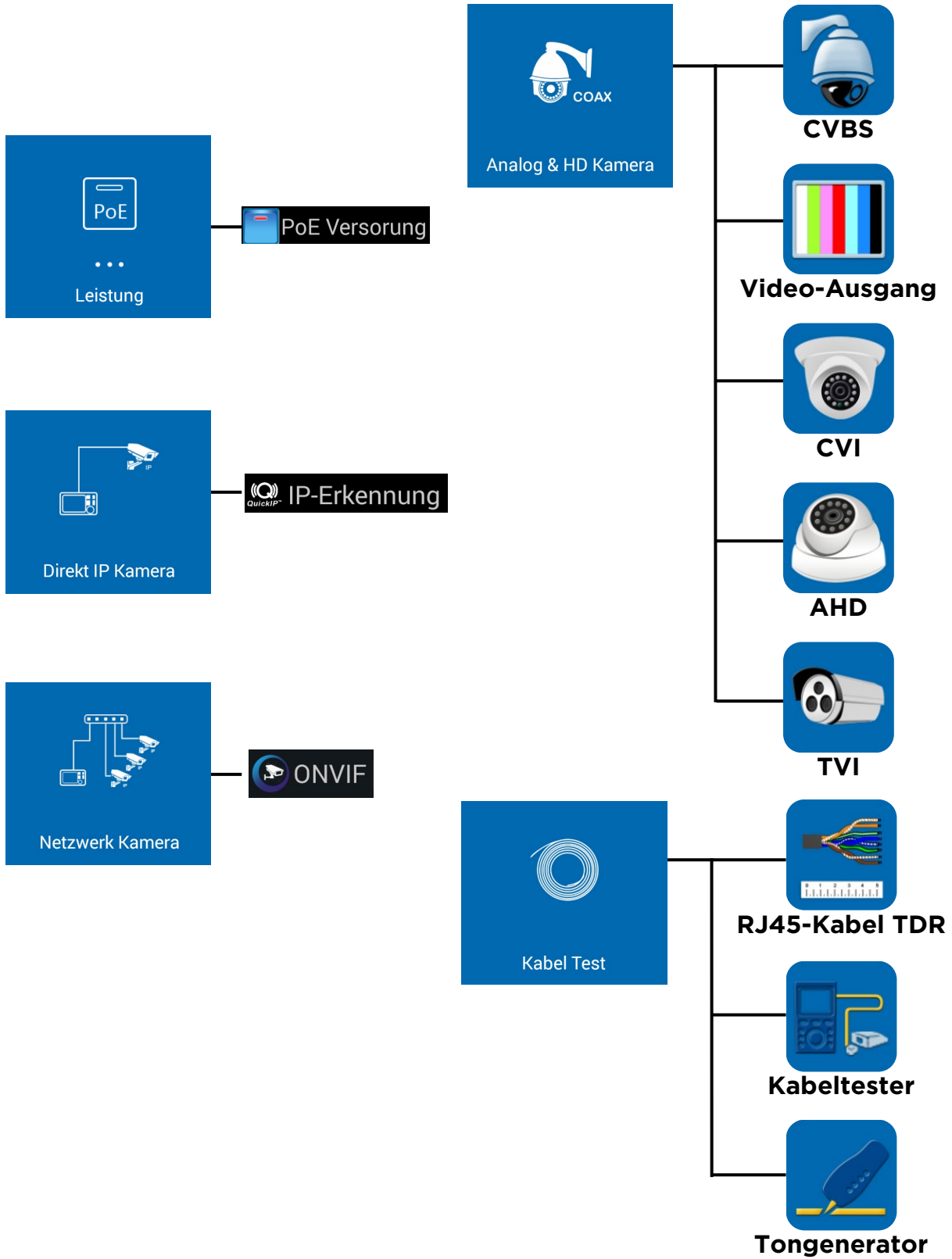

De

Tools und Apps

De

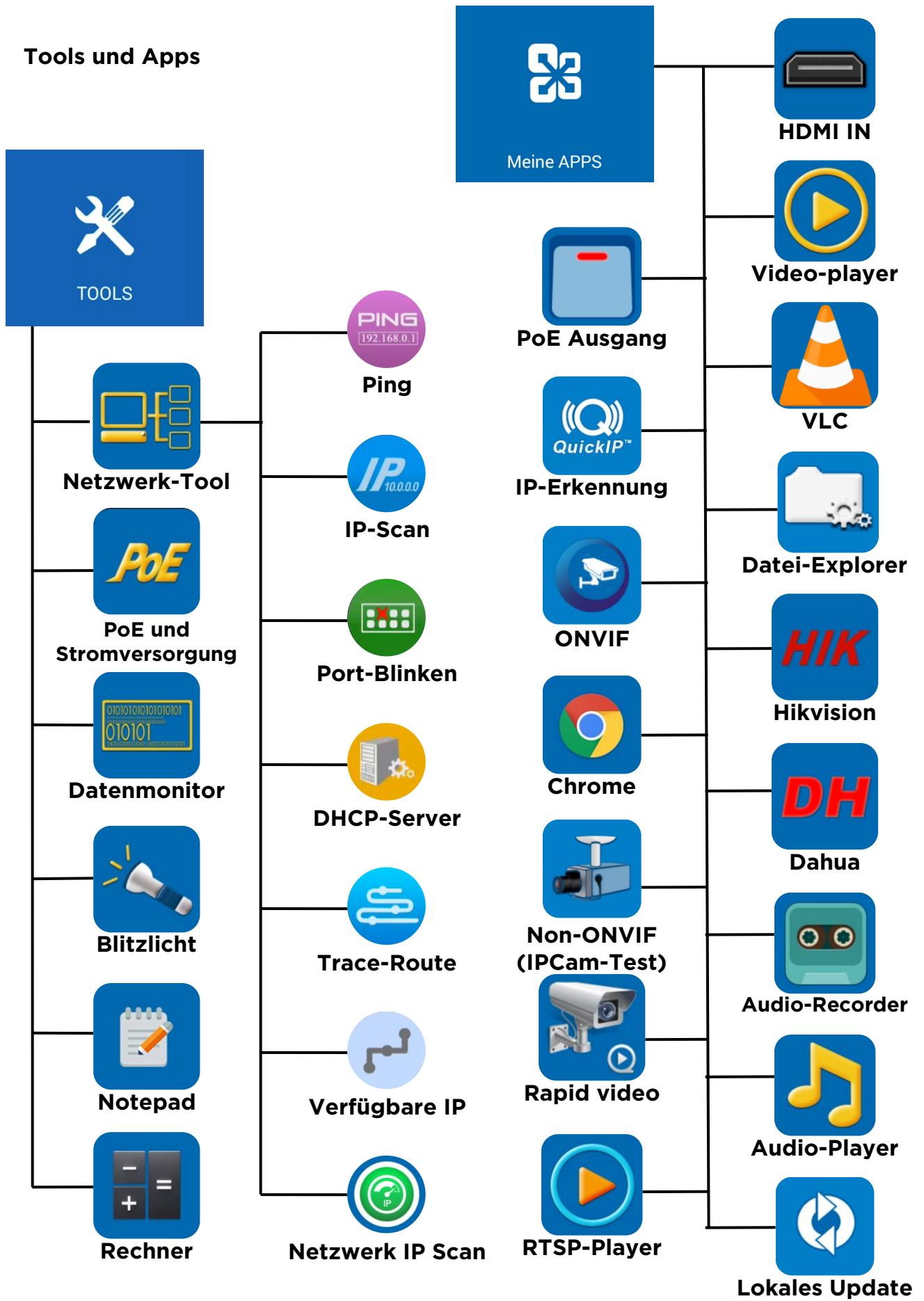

Einstellungen und andere

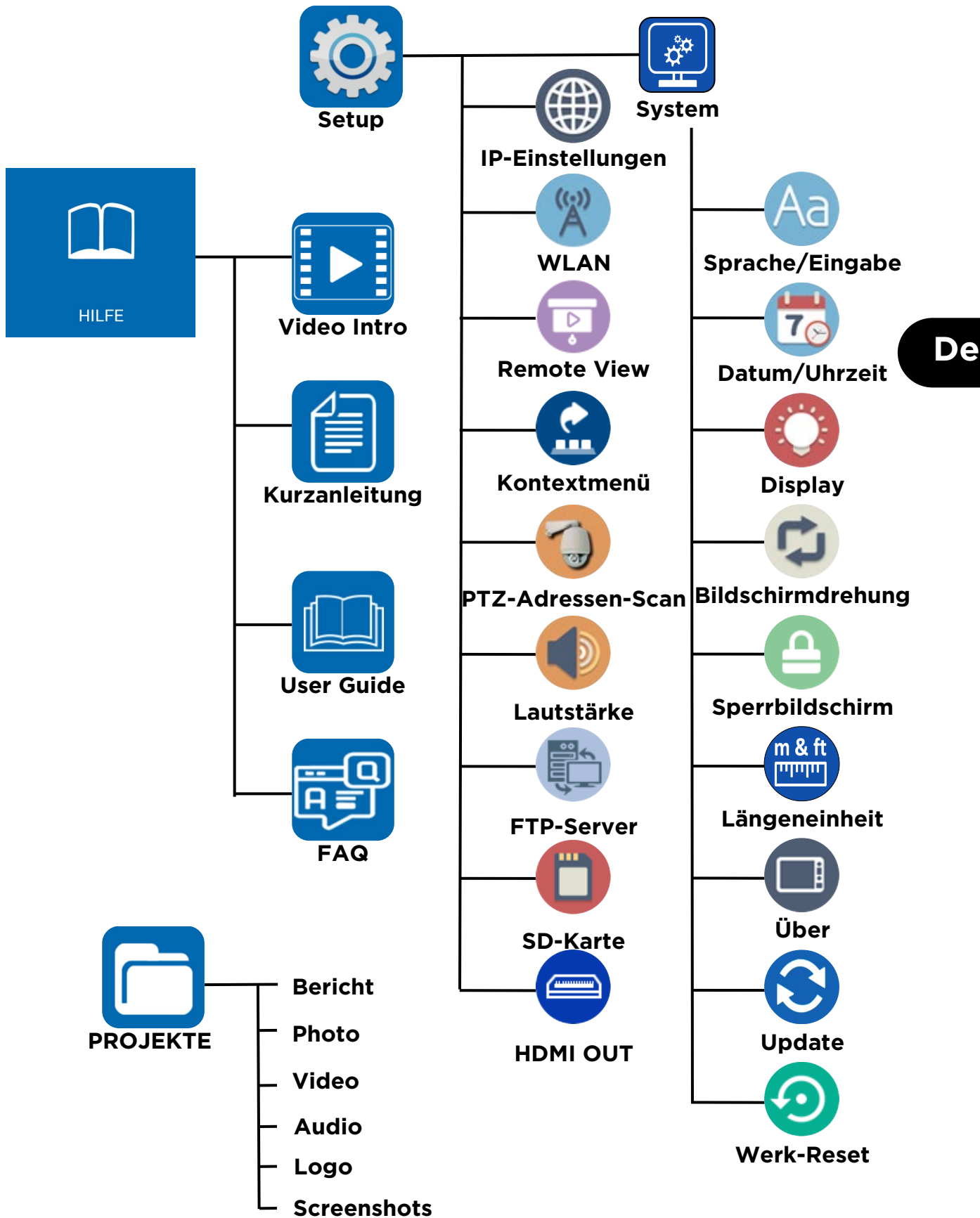

Comandi sul pannello anteriore



Indicatori sul pannello anteriore

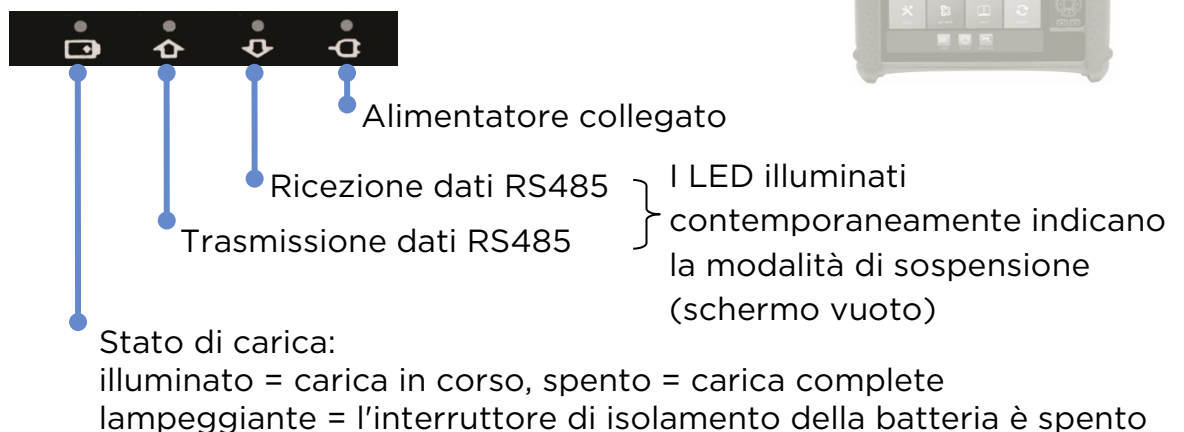

Connettori e indicatori sul pannello superiore

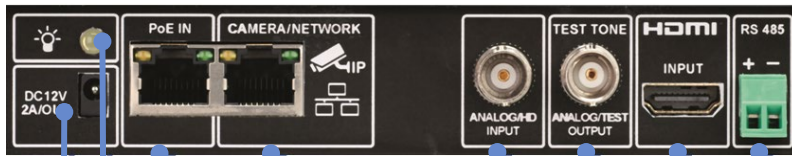

- Torcia a LED
- Uscita da 12 V / 2 A CC per alimentare telecamere non PoE
- Passaggio da PoE rete o PoE iniettore a telecamera; senza trasferimento dati
- Connessione diretta a telecamera IP o rete LAN per accesso telecamere in rete. Uscita PoE selezionabile.
- Ingresso video coassiale per segnale analogico, HD TVI/CVI/AHD
- Generatore tono per coassiale/uscita video
- Ingresso HDMI per controllo NVR/DVR (sostituzione display)
- Interfaccia PTZ RS485



It

Connettori e comandi sul pannello inferiore



- Interruttore isolamento / conservazione batteria
- Ingresso alimentatore 12 V / 2 A
- Ingresso e uscita audio
- Porta USB da 5 V / 2 A per ricarica; connessione dati non disponibile
- Porta per test cavo UTP
- Slot microSD
- Uscita HDMI per test del monitor



Barra di stato dello schermo



- Premere l'icona dell'applicazione per aprire la guida della schermata attuale.
- Stato scheda microSD
- Stato collegamento porta telecamera/rete
- Stato della batteria
- Ora
- Premere X per chiudere la schermata.



TEST DELLA TELECAMERA IP

Alimentazione telecamera

ACCENSIONE

RILEVAMENTO
TELECAMERA IP

ACCESSO
ALLA
TELECAMERA

CONFIGURAZIONE
TELECAMERA

REPORT /
SCHERMATA
ACQUISITA

Le telecamere possono essere alimentate dall'uscita a 12 V / 2 A CC o con tecnologia PoE (Power over Ethernet).

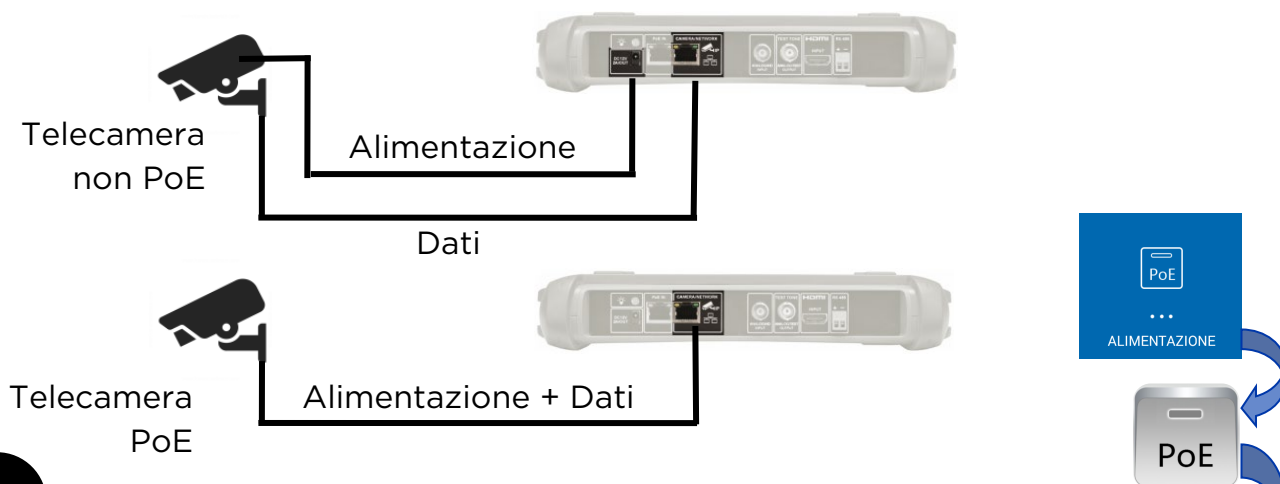

It

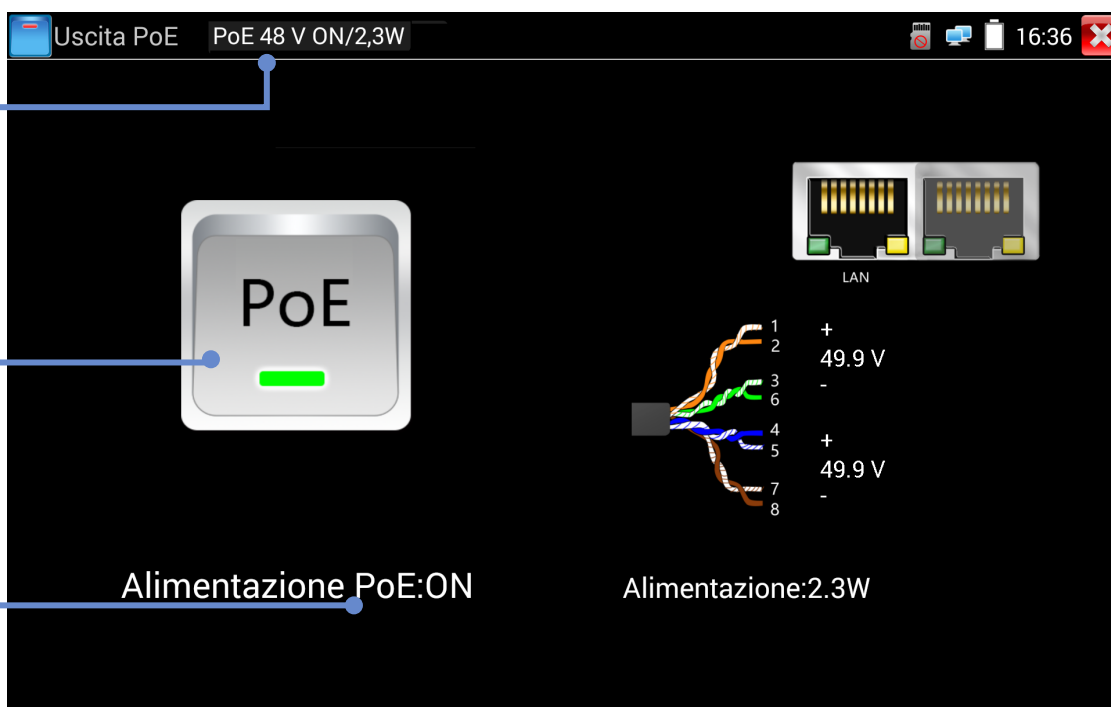

Visualizza le impostazioni dell'uscita di alimentazione

Toccare **OFF** per interrompere l'alimentazione. Toccare **ON** per inserire l'alimentazione

Visualizza la tensione PoE, lo stato e la potenza assorbita dalla telecamera.

Rilevamento rapido dispositivo IP



Lo strumento Scoperta IP consente di rilevare e testare le telecamere IP connesse. Le telecamere possono essere connesse direttamente o tramite una rete.



It

- Toccare **AGGIORNA** per avviare nuovamente lo strumento Scoperta IP dopo un timeout.
- Toccare **TELECAMERA NON-ONVIF** per accedere alla funzione Test Non-ONVIF.
- Visualizza i risultati del test del PING. Toccare Avvia per eseguire il test del PING della telecamera rilevata per verificare la connessione di rete.
- Toccare **BROWSER WEB** per accedere alla telecamera
- Toccare **TELECAMERA ONVIF** per connettersi alle telecamere compatibili ONVIF.
- Controlla e indica se il DHCP è attivato o disattivato
- Visualizza l'indirizzo IP del tester e l'indirizzo IP rilevato della telecamera connessa
- Visualizza la tensione PoE, lo stato e la potenza assorbita dalla telecamera

Test delle telecamere ONVIF



Le telecamere compatibili con i metodi di comunicazione standard stabiliti dall'Open Network Video Interface Forum (ONVIF) possono essere connesse e testate senza modificare manualmente i dettagli della connessione, indipendentemente dalla marca della telecamera.

The screenshot shows the ONVIF mobile application interface. At the top, it displays 'ONVIF PoE 48 V ON/3,2W Flusso principale 1920x1080 h264' and the time '14:41'. Below this is a navigation bar with 'Collegatoadmin' and 'Esci'. The main area shows a live video feed of a store aisle with a timestamp '03-08-2017 Wed 20:37:55'. On the left, there is a list of devices with details for a Hikvision camera. At the bottom, there is a toolbar with icons for 'menu', 'camera', 'PTZ', 'RTSP', and 'doc'. A black box with the text 'It' is on the left side of the page.

- Toccare un'icona per visualizzare il menu di configurazione della telecamera, acquisire e riprodurre foto e video, controllare il brandeggio, intervenire sull'indirizzo RTSP, visualizzare anteprime e creare dei report dei test. Toccare e trascinare la barra degli strumenti per visualizzare l'icona "?".
- Toccare **impostazioni** per regolare le impostazioni ONVIF
- Toccare **Aggiungi** per aggiungere una nuova telecamera inserendo il relativo URL. Toccare **Aggiorna** per aggiornare l'Elenco dei dispositivi
- Visualizza il flusso video dalla telecamera connessa. Toccare due volte per attivare o disattivare la visualizzazione a schermo intero.
- Visualizza un elenco delle telecamere disponibili. Toccare una telecamera per connetterla.
- Visualizza il nome utente della telecamera collegata quando si è connessi. Quando non si è connessi, consente di inserire il nome utente e la password.

STRUTTURA DEI MENU

Prove

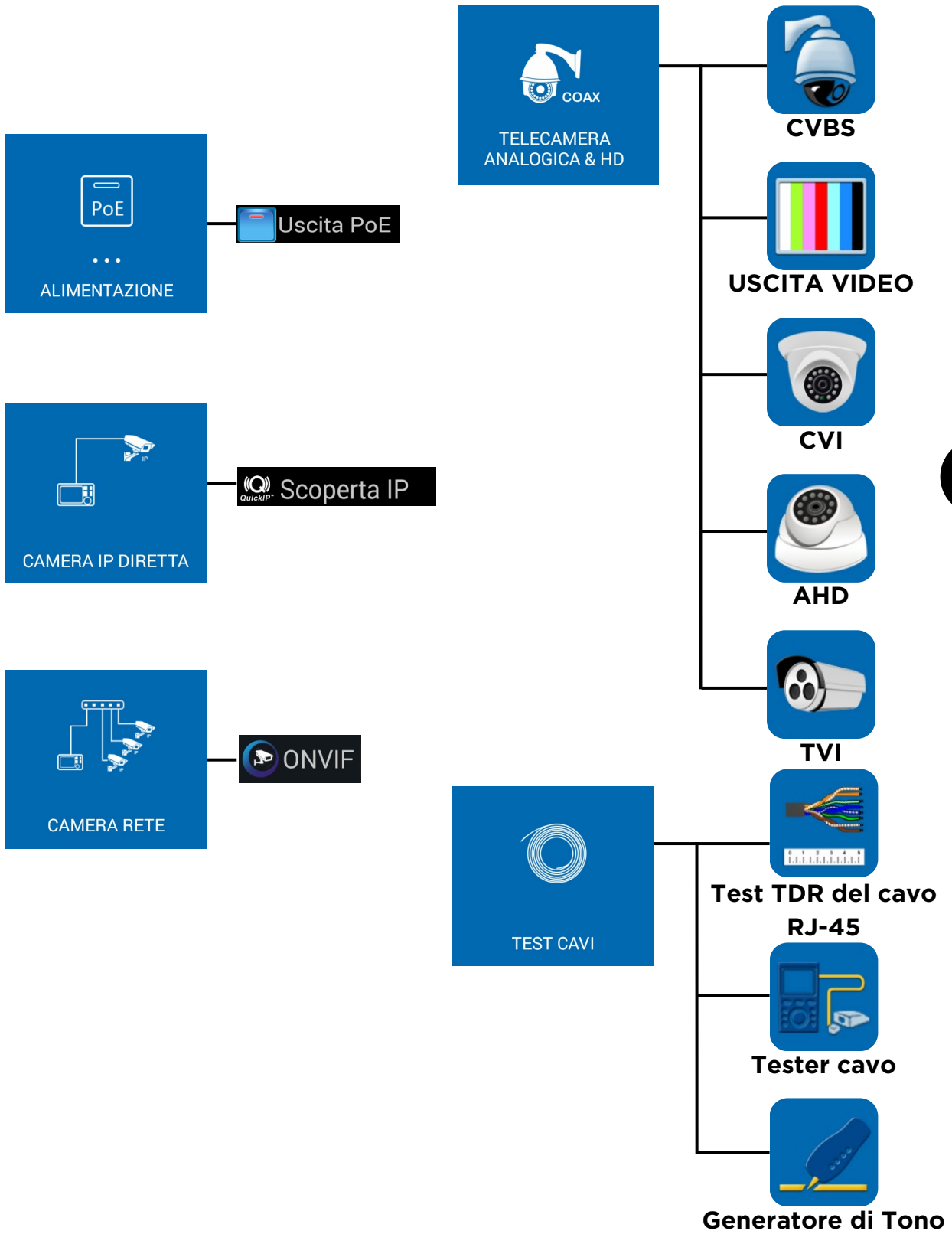

Strumenti e app

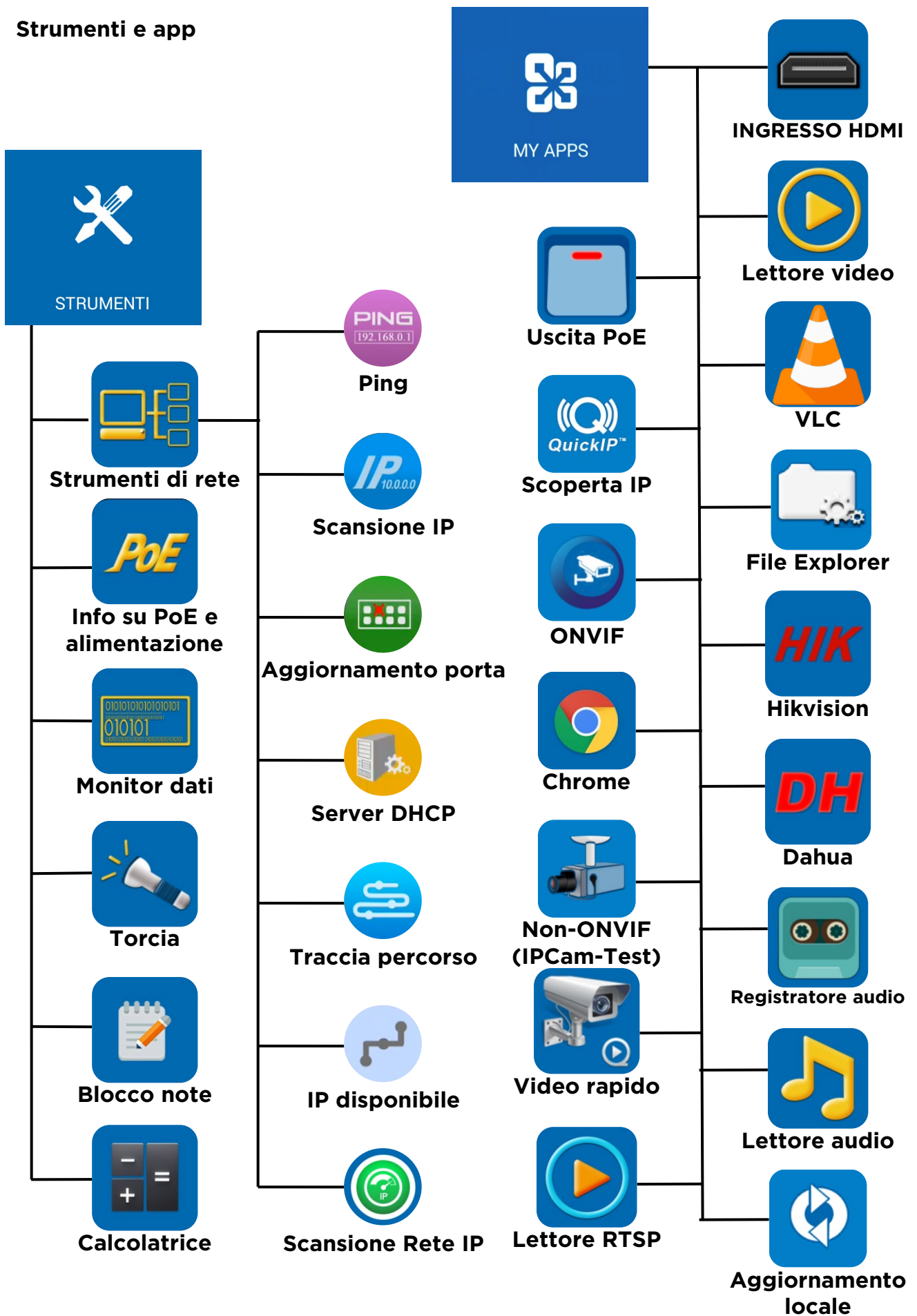

It

Setup e altri

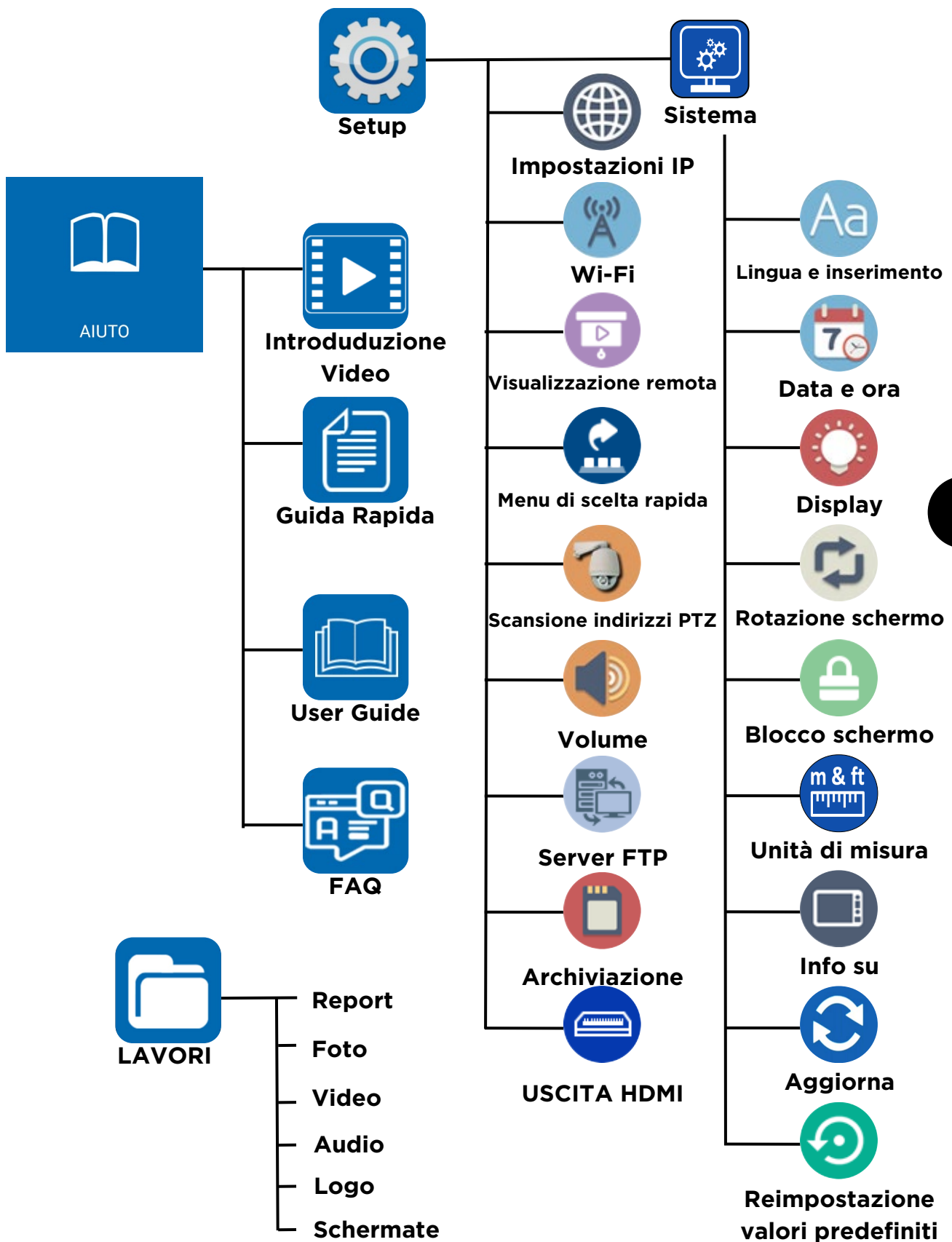

Controles del panel frontal



Indicadores del panel frontal



- Adaptador de corriente conectado
 - Recepción de datos RS485
 - Transmisión de datos RS485
 - Estado de carga: encendido = cargando, apagado = cargado, parpadeando = Interruptor de aislamiento de la batería está apagado
- Todos los LEDs encendidos a la vez indican modo sleep (pantalla en blanco)

Conectores e indicadores del panel superior



- Salida de CC 12 V / 2 A para alimentar cámaras tipo «no PoE»
- LED parpadeante
- Transmite PoE de red o inyector PoE desde PoE hasta la cámara - no transmite datos
- Conexión directa a cámara IP o LAN para acceder a cámaras de red. Salida PoE seleccionable.
- Entrada de vídeo coax para conexión analógica, HD TVI/CVI/AHD
- Salida de vídeo / generador de tonos coax
- Entrada HDMI para comprobación NVR/DVR (reemplaza la pantalla)
- Interfaz RS485 PTZ

Conectores y controles del panel inferior



- Aislamiento de batería / interruptor de almacenamiento
- Entrada del adaptador de corriente 12 V 2 A
- Entrada y salida de audio
- Puerto de carga USB 5V 2A - sin conexión de datos
- Puerto para pruebas de cables UTP
- Ranura de tarjeta microSD
- Salida HDMI para comprobación de monitor

Es

Mostrar la barra de estado

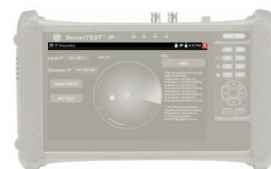

- Pulse el ícono de la aplicación para obtener ayuda sobre la pantalla actual.
- Estado de la tarjeta microSD
- Estado del enlace de cámara / puerto de red
- Estado de la batería
- Hora
- Pulse X para cerrar la pantalla.

COMPROBACIÓN DE CÁMARAS IP

Power Camera



Las cámaras pueden alimentarse tanto por salida CC 12 V / 2 A DC como por alimentación mediante Ethernet (PoE).

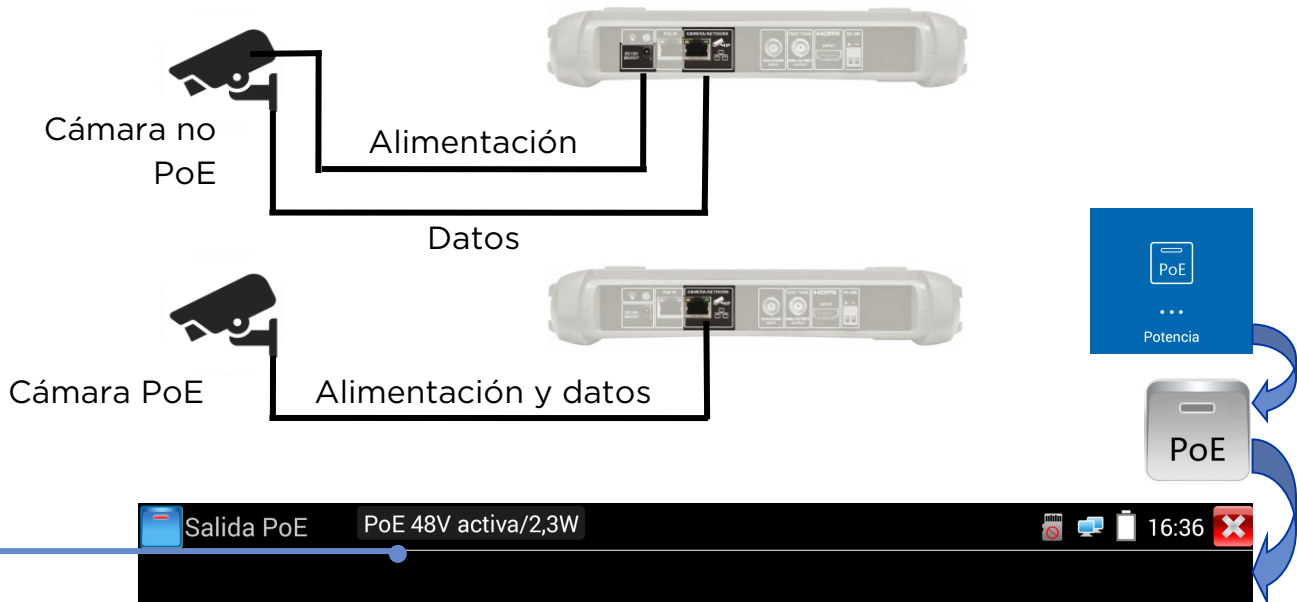

Es

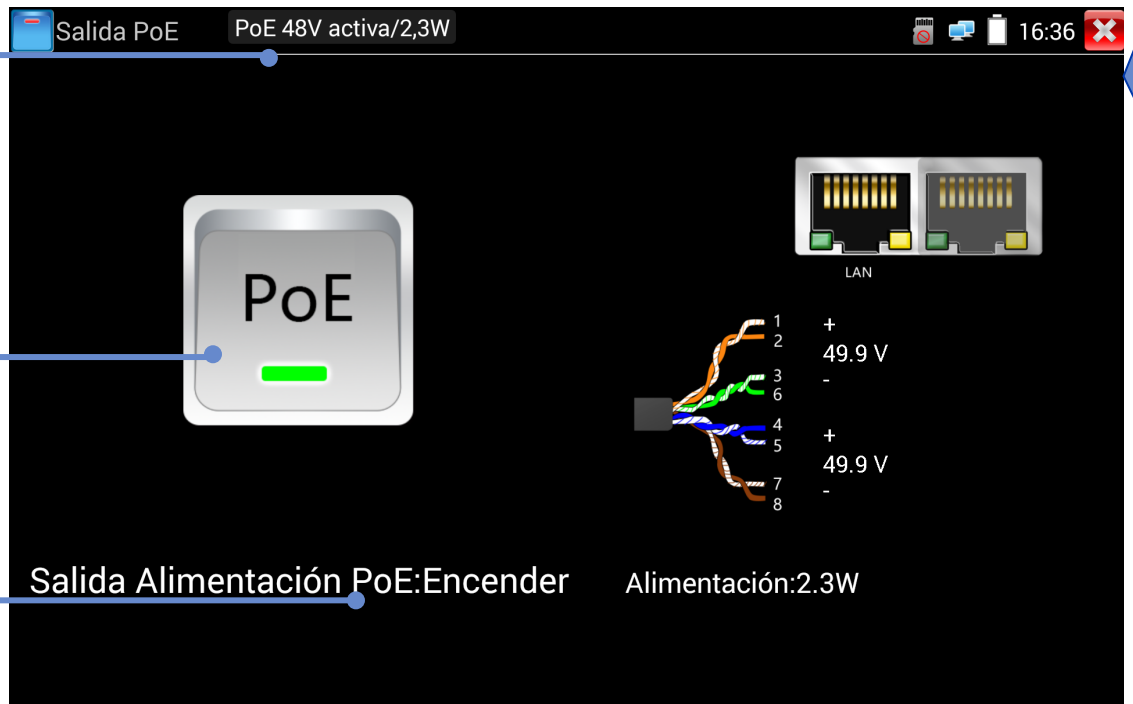

● Visualiza ajuste de la salida de alimentación

● Presione **Apagar** para apagar el equipo. Presione **Encender** para encender el equipo.

● Visualiza tensión PoE, así Como estado y alimentación utilizada por la cámara.

Detección rápida del dispositivo IP



La herramienta de detección de la IP sirve para detectar y comprobar la cámara IP conectada. La cámara puede conectarse directamente o a través de red.

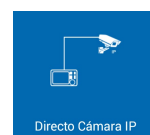

IP local: 192.168.1.254

IP detectada: 192.168.1.64

Servidor DHCP: ON

Cámara ONVIF

Navegador

Cámara Sin ONVIF

Refrescar

PING

Iniciar

PING 192.168.1.64 (192.168.1.64)
56(84) bytes of data.
64 bytes from 192.168.1.64:
icmp_seq=1 ttl=64 time=0.782 ms
64 bytes from 192.168.1.64:
icmp_seq=2 ttl=64 time=1.12 ms
64 bytes from 192.168.1.64:
icmp_seq=3 ttl=64 time=0.964 ms
64 bytes from 192.168.1.64:
icmp_seq=4 ttl=64 time=0.886 ms

— 192.168.1.64 ping statistics —
4 packets transmitted, 4 received,
0% packet loss, time 3002ms
rtt min/avg/max/mdev =
0.782/0.939/1.127/0.131 ms

Es

- Seleccione **REFRESCAR** para volver a iniciar la detección de IP después de una interrupción.
- Seleccione **CÁMARA NON-ONVIF** para acceder a la función IPCam Test.
- Se visualizarán los resultados de la prueba de PING. Seleccione **Iniciar** para hacer un PING a la cámara detectada para verificar la conexión de red.
- Seleccione **NAVEGADOR** para acceder a la cámara.
- Seleccione **CÁMARA ONVIF** para conectar a cámaras compatibles con ONVIF.
- Controla e indica el encendido o apagado del DHCP.
- Visualiza dirección IP del equipo de pruebas y dirección IP detectada de la cámara conectada.
- Visualiza tensión PoE, así como estado y alimentación utilizada por la cámara.

Prueba de ONVIF de la cámara



Las cámaras compatibles con los métodos estándar de comunicaciones establecidos por la organización Open Network Video Interface Forum (ONVIF) pueden conectarse y comprobarse sin ningún ajuste manual en los detalles de conexión y independientemente de la marca comercial de la cámara.

Es

- Seleccione un ícono para mostrar el menú de configuración de la cámara, capturar y reproducir vídeos y fotos, desplazar/inclinar/acercar/alejar vídeos y fotos, mostrar las direcciones RTSP o previsualizar y crear informes de pruebas. Seleccione y arrastre la barra de herramientas para visualizar el
- Seleccione **Configuración** para ajustar la configuración ONVIF.
- Seleccione **Añadir** para añadir una nueva cámara utilizando su URL. Seleccione **Refrescar** para actualizar la Lista de dispositivos.
- Visualiza el flujo de vídeo de la cámara conectada. Seleccione dos veces para abrir/cerrar pantalla completa.
- Visualiza una lista de cámaras disponibles. Seleccione una cámara para conectarla.
- Visualiza el nombre del usuario conectado de la cámara conectada. Si el usuario está desconectado, se puede introducir el nombre de usuario y su contraseña.

ÁRBOLES DE MENÚS

Pruebas

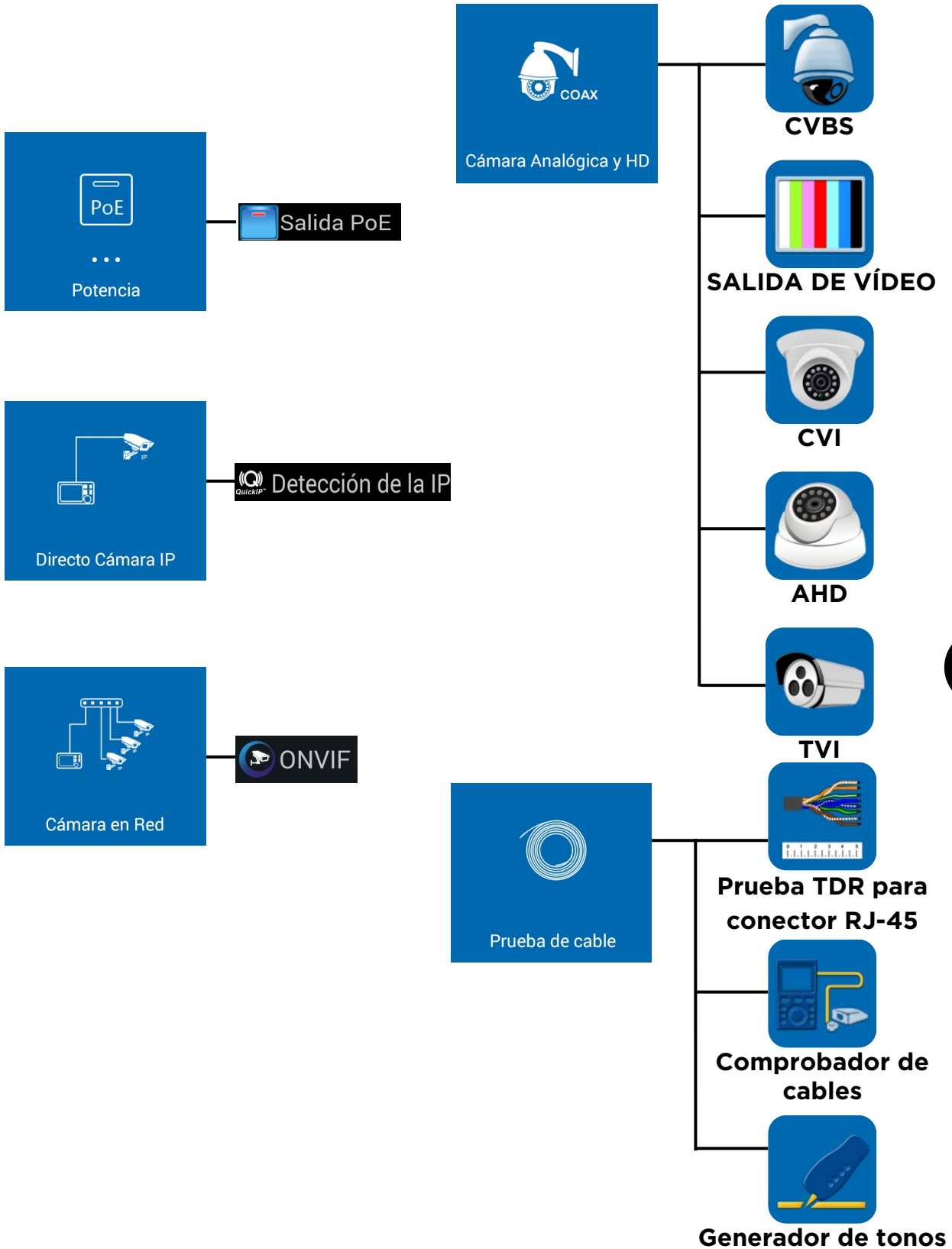

Es

Herramientas y aplicaciones

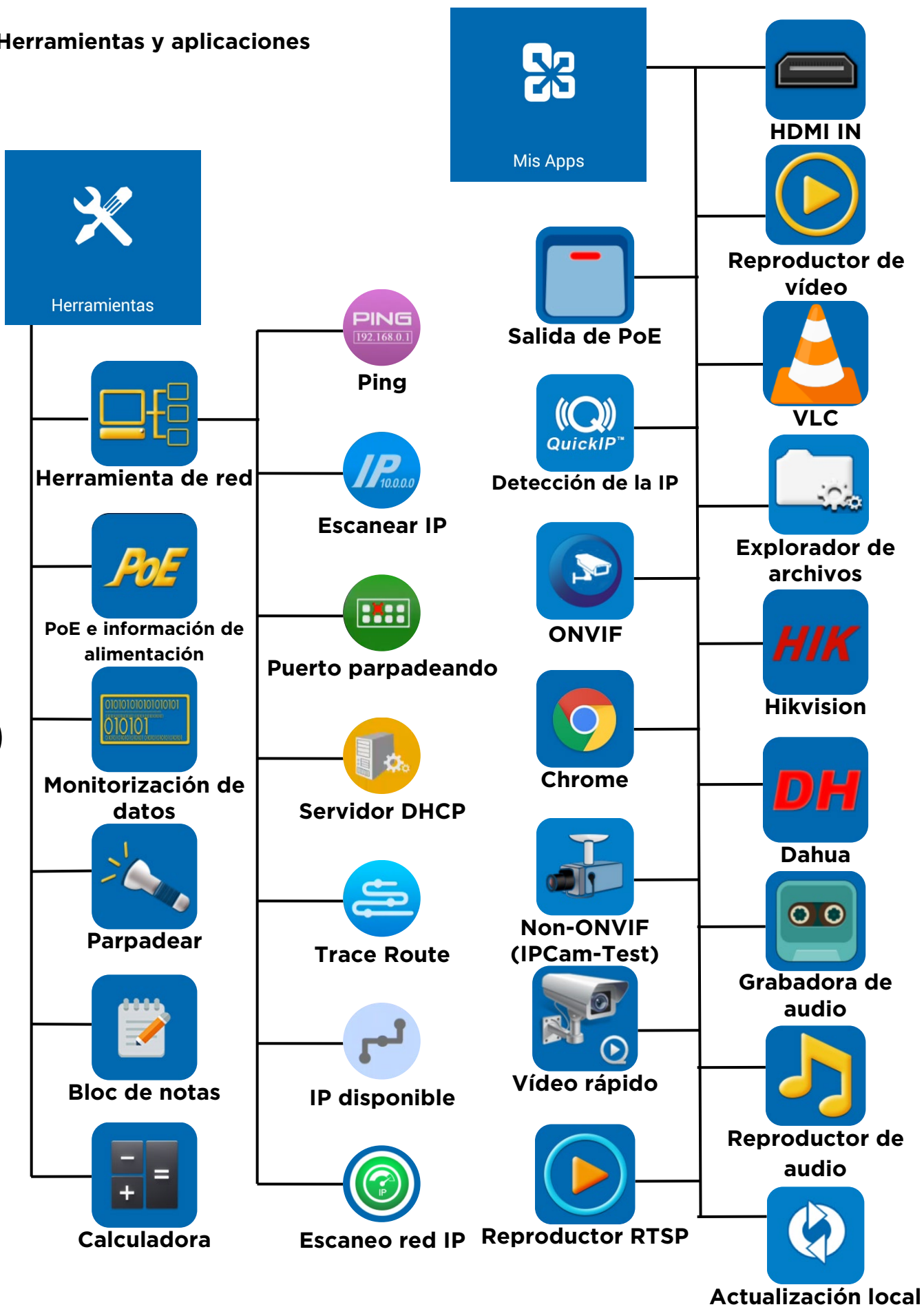

Es

Configuración y otras

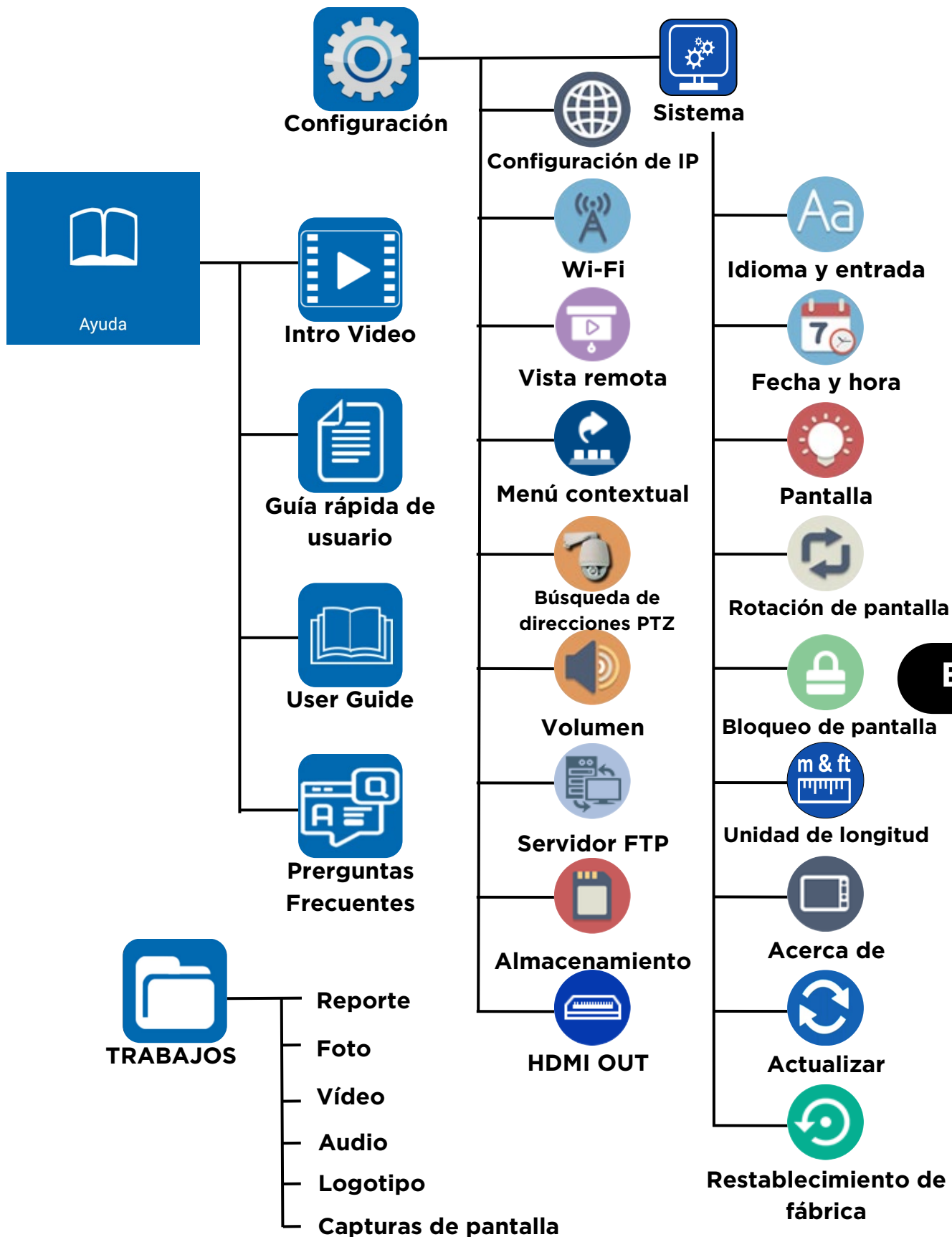

Controles do painel frontal



Mantenha o botão pressionado para LIGAR/DESLIGAR.

Pressione brevemente para hibernar / despertar

Tela inicial / menu de atalhos

Alternar zoom digital

Afastar Foco

Aproximar Foco

Aproximar

Afastar

Abrir ou aumentar a abertura / confirmar

Fechar ou diminuir a abertura / sair do menu da câmera

Menu de navegação / Controles PTZ

Confirma as configurações e retorna. Mantenha pressionado para capturar a tela

Retorna sem confirmar configurações. Mantenha pressionado para voltar à tela inicial

Pt

Indicadores do painel frontal



Adaptador de energia conectado

Recebendo dados RS485

Transmitindo dados RS485

Status de carregamento: aceso=carregando, apagado=carregado
Piscando = Botão da bateria na posição desligado

Todos os LEDs acesos indica modo de hibernação (tela em branco)

Conectores e indicadores do painel superior

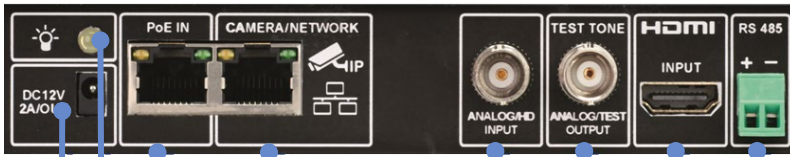

- Saída CC de 12 Volts / 2 Amp para alimentar câmeras sem PoE
- Lanterna LED
- Passa PoE da rede ou do injetor PoE para câmera - não passa dados
- Conexão direta à câmera IP ou à LAN para acessar câmeras na rede. Saída PoE configurável.
- Entrada coaxial de vídeo analógico e HD TVI/CVI/AHD
- Saída coaxial de vídeo analógico/gerador de tom
- Entrada HDMI para verificação de NVR/DVR (substituindo exibição)
- Interface PTZ RS485

Conectores e controles do painel inferior



- Interruptor para isolamento da bateria / armazenamento
- Entrada do adaptador de energia de 12 Volts 2 Amp
- ENTRADA e SAÍDA de áudio
- Porta de carregamento USB 5V 2A - sem conexão de dados
- Porta para teste de cabo UTP
- Entrada de cartão MicroSD
- Saída HDMI para teste do monitor



Barra de status da tela



- Toque no ícone do aplicativo para obter ajuda na tela atual
- Status do cartão MicroSD
- Status da conexão da porta da câmera/rede
- Status da bateria
- Hora
- Toque no X para fechar a tela



TESTE DE CÂMERAS IP

Alimentação da câmera



As câmeras podem ser conectadas à saída de 12 Volts / 2 Amp CC ou por Power over Ethernet (PoE).

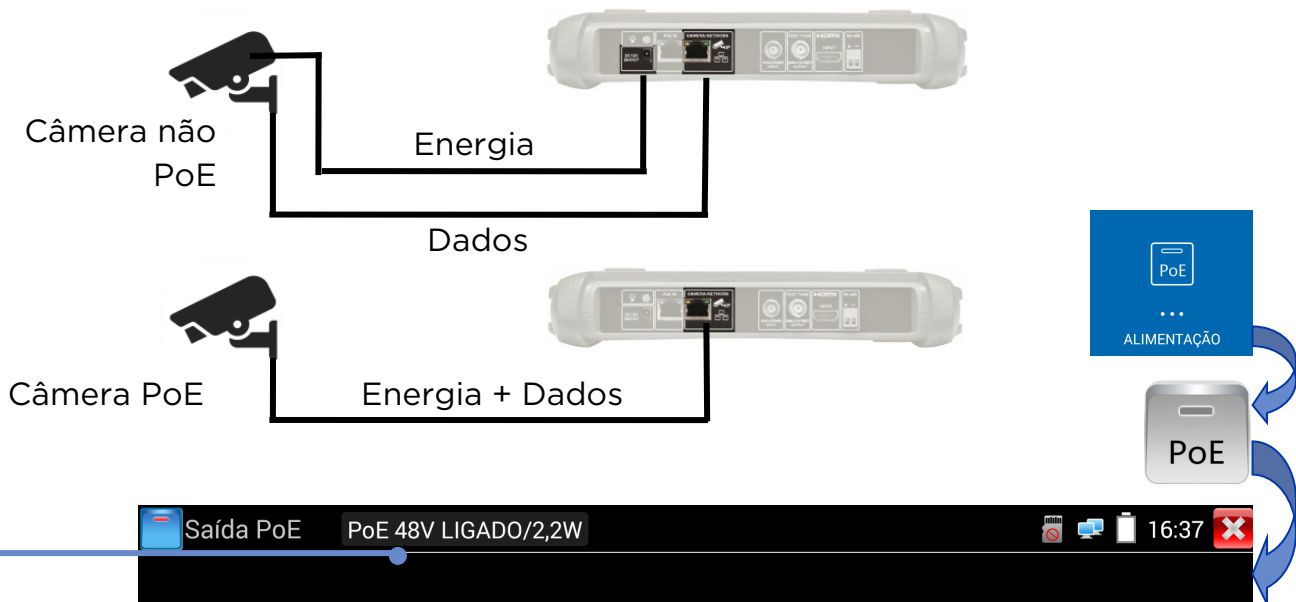

Pt

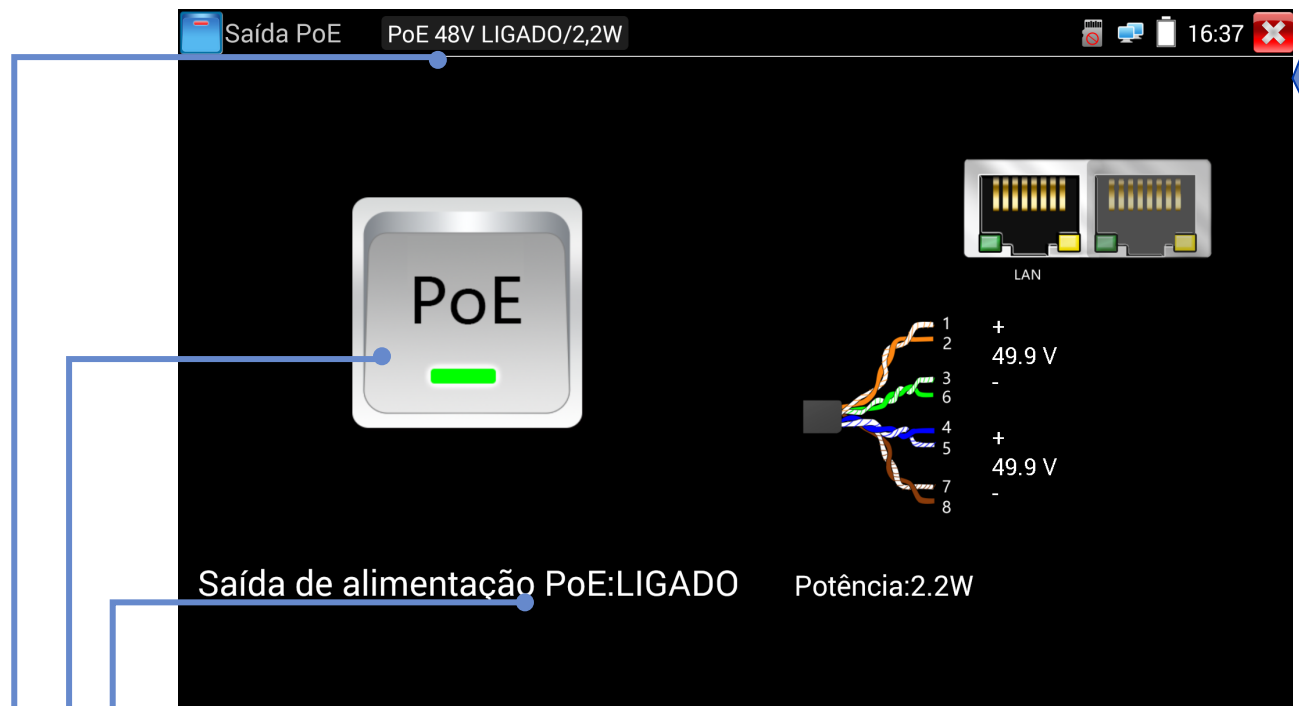

- Exibe a configuração da saída de alimentação
- Toque em **DESLIGAR** para desligar. Toque em **LIGAR** para ligar
- Exibe a tensão PoE, o status e a potência consumida pela câmera.

Descoberta Rápida do IP do Dispositivo

A ferramenta Descoberta de IP possui recursos para encontrar e testar uma câmera IP conectada. A câmera pode ser conectada diretamente ou através da rede.



- Toque em **ATUALIZAR** para reiniciar a descoberta de IP após um período sem atividade.
- Toque em **CÂMERA NÃO-ONVIF** para acessar a função IPCam.
- Exibe os resultados do teste de PING. Toque em iniciar para efetuar PING na câmera detectada e verificar sua conexão à rede.
- Toque em **NAVEGADOR WEB** para acessar a câmera
- Toque em **CÂMERA ONVIF** para se conectar a câmeras compatíveis com ONVIF.
- Controla e indica se o DHCP está habilitado ou DESLIGADO
- Exibe o endereço IP do testador e o endereço IP descoberto da câmera conectada
- Exibe a tensão PoE, o status e a potência consumida pela câmera

Pt

Teste de Câmeras ONVIF



Câmeras compatíveis com os métodos padrão de comunicação estabelecidos pelo Open Network Video Interface Forum (ONVIF) podem ser conectadas e testadas sem a necessidade de fazer ajustes manuais aos detalhes da conexão, independentemente da marca da câmera.

The screenshot shows the ONVIF web interface. At the top, it displays 'ONVIF PoE 48V LIGADO/3,2W Fluxo Principal 1920x1080 h264' and the time '16:01'. Below this, there is a 'Logado:admin' status and a 'Logout' button. A sidebar on the left shows 'Dispositivos(1)' with details for a Hikvision camera: 'HIKVISION DS-2DE2202L-DE3/W', 'Número da câmera 1', '192.168.1.64', and 'Local city/hangzhou'. There are 'Incluir' and 'Atualiz...' buttons. The main area shows a live video feed of a store aisle with a timestamp '03-08-2017 Wed 20:37:55'. At the bottom, there is a 'Configuração ONVIF' button and a toolbar with icons for 'menu', 'photo', 'video', 'PTZ', 'RTSP', and 'doc'. Annotations with blue lines point from the text below to these interface elements.

- Toque em um ícone para exibir o menu de configuração da câmera, capturar e reproduzir fotos e vídeos, para as funções Panorâmica/Inclinação/Zoom, endereço RTSP, pré-visualização e para criar relatórios de teste. Toque e arraste a barra de ferramentas para exibir o ícone “?”.
- Toque em **configuração** para ajustar os parâmetros ONVIF
- Toque em **Adicionar** para agregar uma nova câmera usando sua URL. Toque em Atualizar para atualizar a Lista de Dispositivos
- Exibe o fluxo de vídeo da câmera conectada. Toque duas vezes para alternar entre entrar e sair da exibição em tela cheia.
- Exibe a lista de câmeras disponíveis. Toque na câmera para se conectar a ela.
- Exibe o nome de usuário da câmera conectada quando logado. Ao efetuar logout, permite a digitação do nome do usuário e da senha.

Pt

ESTRUTURA DO MENU

Testes

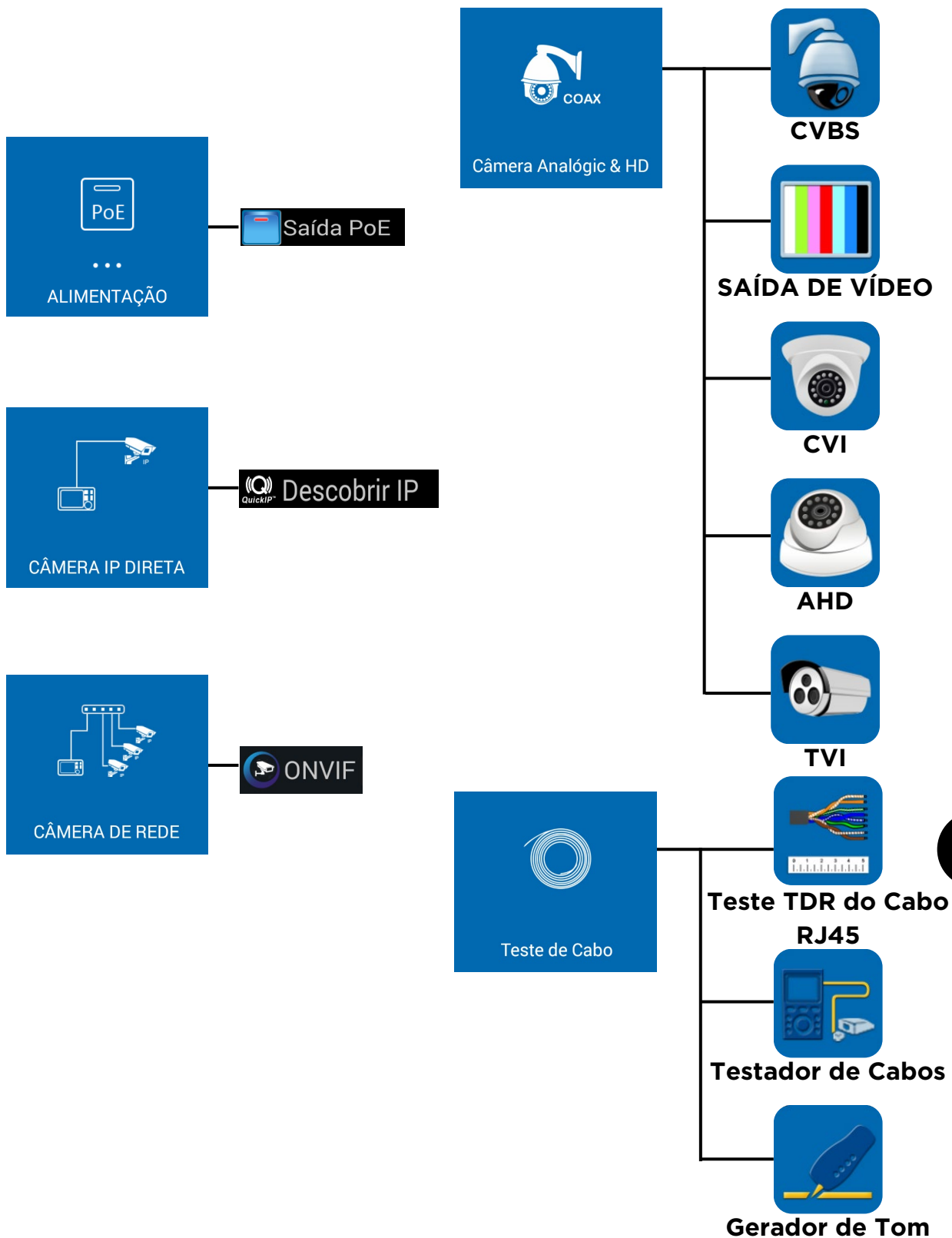

Ferramentas e Apps

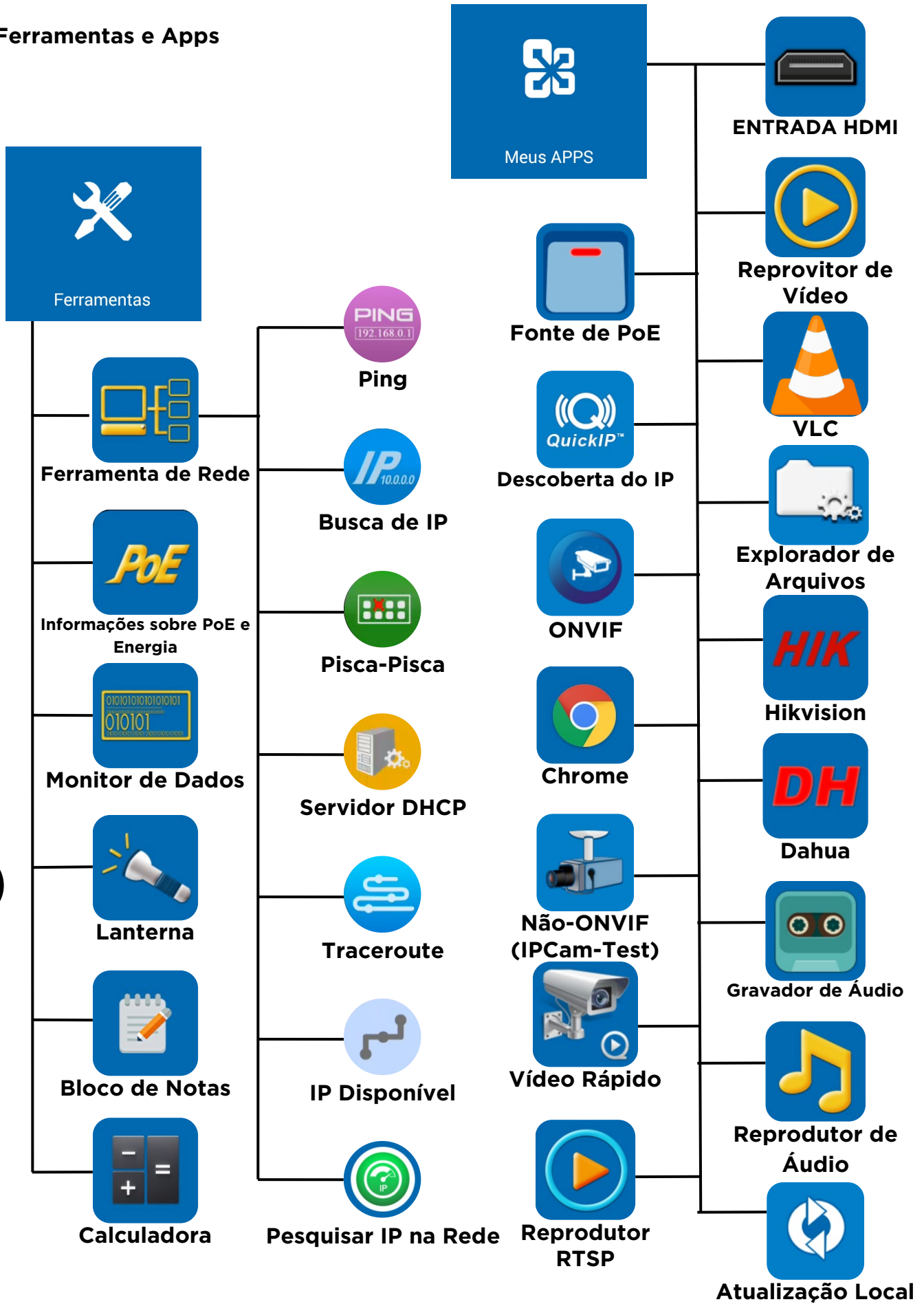

Pt

Configuração e outros

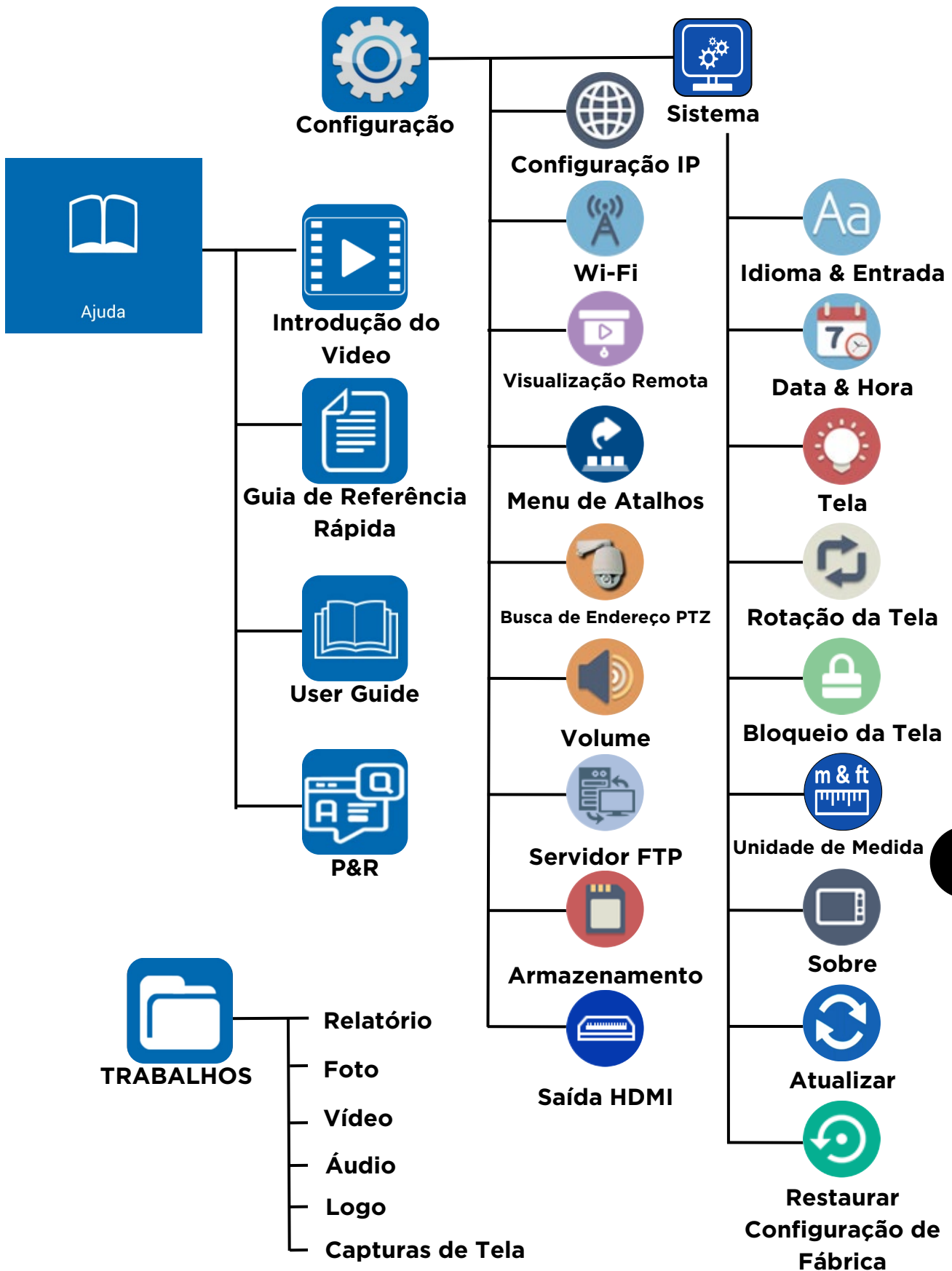

Pt

前控制面板



前面板指示灯



中文

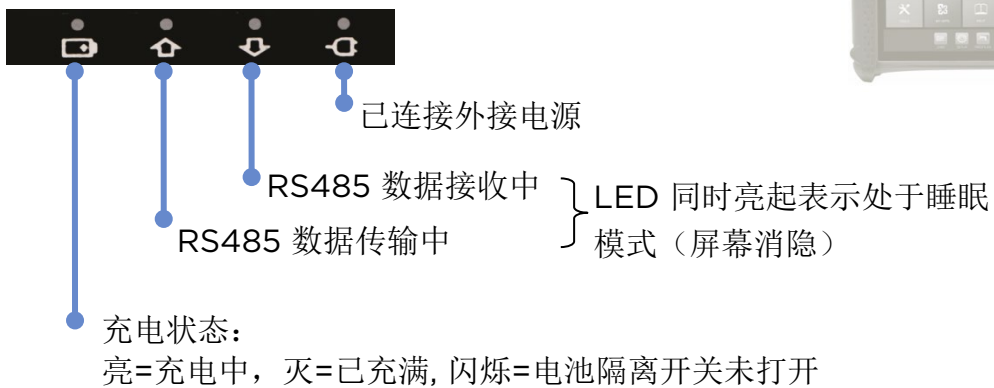

顶部面板接口与指示灯

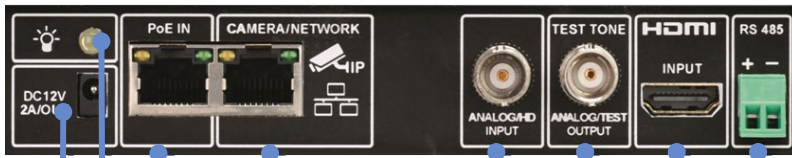

- LED 灯
- 12V/2A 直流输出用于为非 PoE 供电摄像机用
- 将网络 PoE 或 PoE 供电模块透明传到摄像机 - 无数据透明传输
- 直接连接到 IP 摄像机或 LAN 以访问网络摄像机。PoE 输出可选。
- 用于模拟高清 TVI/CVI/AHD 的同轴视频输入
- 视频输出/同轴音频发生器
- 用于 NVR/DVR 检查的 HDMI 输入 (代替监视器)
- RS485 PTZ 接口

底部面板接口和控制



- 电池隔离/存储开关
- 12V/2A 电源适配器输入
- 音频输入和输出
- USB 5V 2A 充电端口 - 无数据连接
- UTP 线缆测试端口
- MicroSD 卡插槽
- 用于测试监视器的 HDMI 输出

状态显示栏



- 点击应用图标, 在当前屏幕获取在线帮助。
- MicroSD 卡状态
- 摄像机/网络端口链接状态
- 电量
- 当前时间
- 点击 X, 关闭屏幕。



中文

IP 摄像机测试

摄像机加电



像机可以通过 12V/2A 直流输出或以太网供电模块(PoE)被供电。

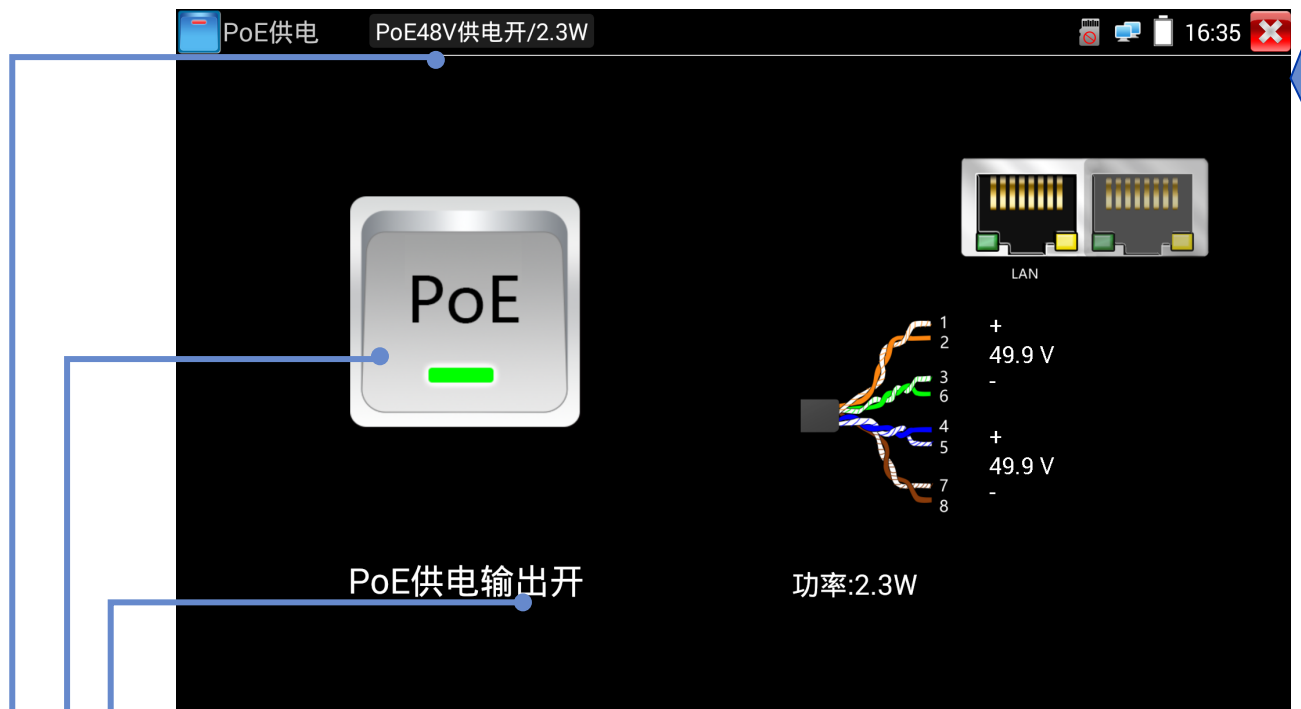
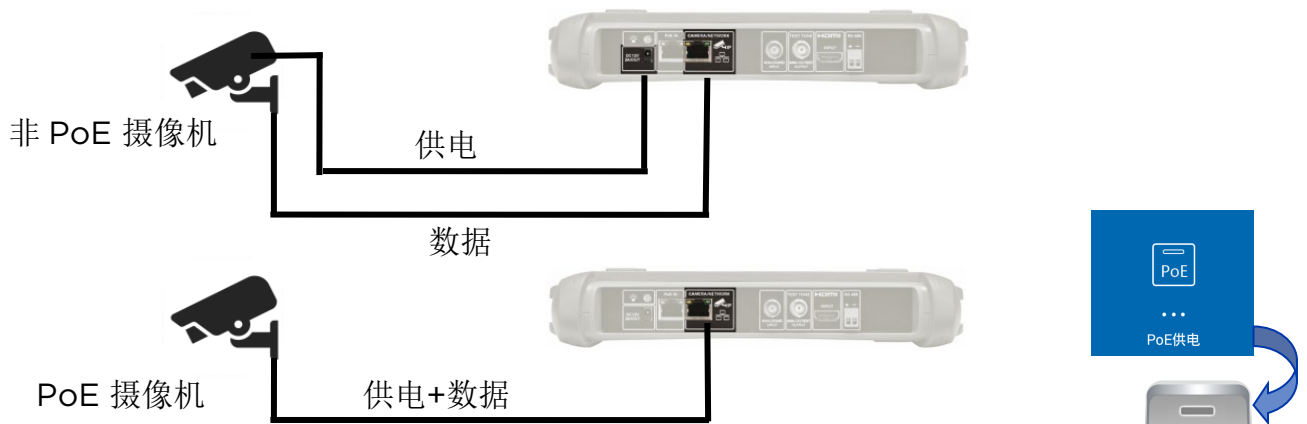

中文

- 显示电源输出的设置及状态
- 轻触 PoE 开关进行关闭或开启 PoE 供电
- 显示 PoE 电压、状态和摄像机功率。双击弹出或收回详情窗口

快速发现设备 IP



IP 发现工具用于发现和测试连接的摄像机 IP 地址。摄像机可以直接连接或通过网络连接。本列图仅适用于单个摄像机连接测试。



本机IP: 192.168.1.245

PoE48V供电开/OV

摄像机已启动完毕

已发现IP: 192.168.1.64

DHCP服务器: ON

ONVIF摄像机

网页浏览器

非ONVIF摄像机

刷新

PING

开始

PING 192.168.1.64 (192.168.1.64)
56(84) bytes of data:
64 bytes from 192.168.1.64:
icmp_seq=1 ttl=64 time=0.891 ms
64 bytes from 192.168.1.64:
icmp_seq=2 ttl=64 time=0.890 ms
64 bytes from 192.168.1.64:
icmp_seq=3 ttl=64 time=0.842 ms
64 bytes from 192.168.1.64:
icmp_seq=4 ttl=64 time=1.15 ms

— 192.168.1.64 ping statistics —
4 packets transmitted, 4 received,
0% packet loss, time 3002ms
rtt min/avg/max/mdev =
0.842/0.944/1.155/0.126 ms

- 轻触刷新在超时后再次启动 IP 地址发现。
- 轻触非 ONVIF 摄像机以访问非 ONVIF 测试功能。
- 显示 PING 测试的结果。轻触开始对检测到的摄像机进行 PING 测试以验证网络连接正常与否。
- 轻触 WEB 浏览器访问摄像机
- 轻触 ONVIF 摄像机以连接兼容 ONVIF 的摄像机。
- 控制并指示 DHCP 是启用还是关闭状态
- 显示测试仪的 IP 地址和发现所连摄像机的 IP 地址
- 显示 PoE 电压、状态和摄像机功率消耗状态

中文

ONVIF 摄像机测试



可以连接和测试符合 ONVIF 协议的标准通讯方式的摄像机，无需对连接详细信息进行任何品牌摄像机的手动调整除摄像机的用户名和密码之外。

网连IP摄像机测试

ONVIF摄像机

ONVIF PoE48V供电开/3.2W 主码流 1920x1080 h264 16:04

登录: admin 登出

设备列表(1)

HIKVISION DS-2DE2202I-DE3/W
序号 1
192.168.1.64
位置 city/hangzhou

增加 刷新

onvif设置

03-08-2017 Wed 20:32:55

menu 捕获 播放 平移/倾斜/缩放 PTZ RTSP doc

- 轻触图标显示摄像机设置菜单、捕获和播放照片及视频、平移/倾斜/缩放(云台控制)、RTSP 地址、预览和生成测试报告。轻触并拖动工具栏以显示“?” 图标。
- 轻触设置以调整 ONVIF 设置
- 轻触添加以使用 URL 添加新摄像机。轻触刷新以更新设备列表
- 显示连接的摄像机的视频流。双击以打开/关闭全屏显示。
- 显示可用摄像机的列表。轻触摄像机进行连接。
- 登录时显示连接的摄像机用户名。注销时，允许输入用户名和密码。

中文

菜单树

多项测试

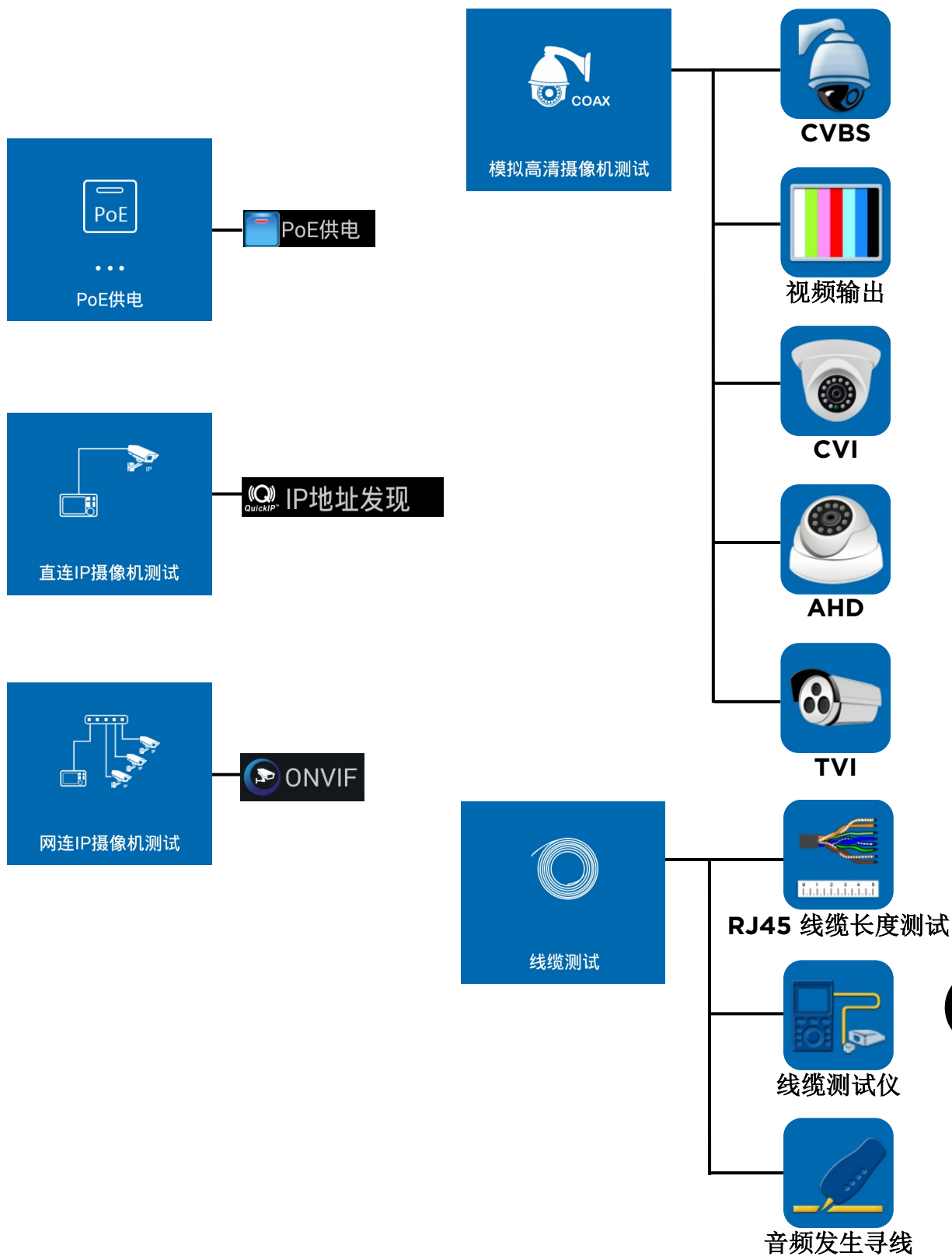

中文

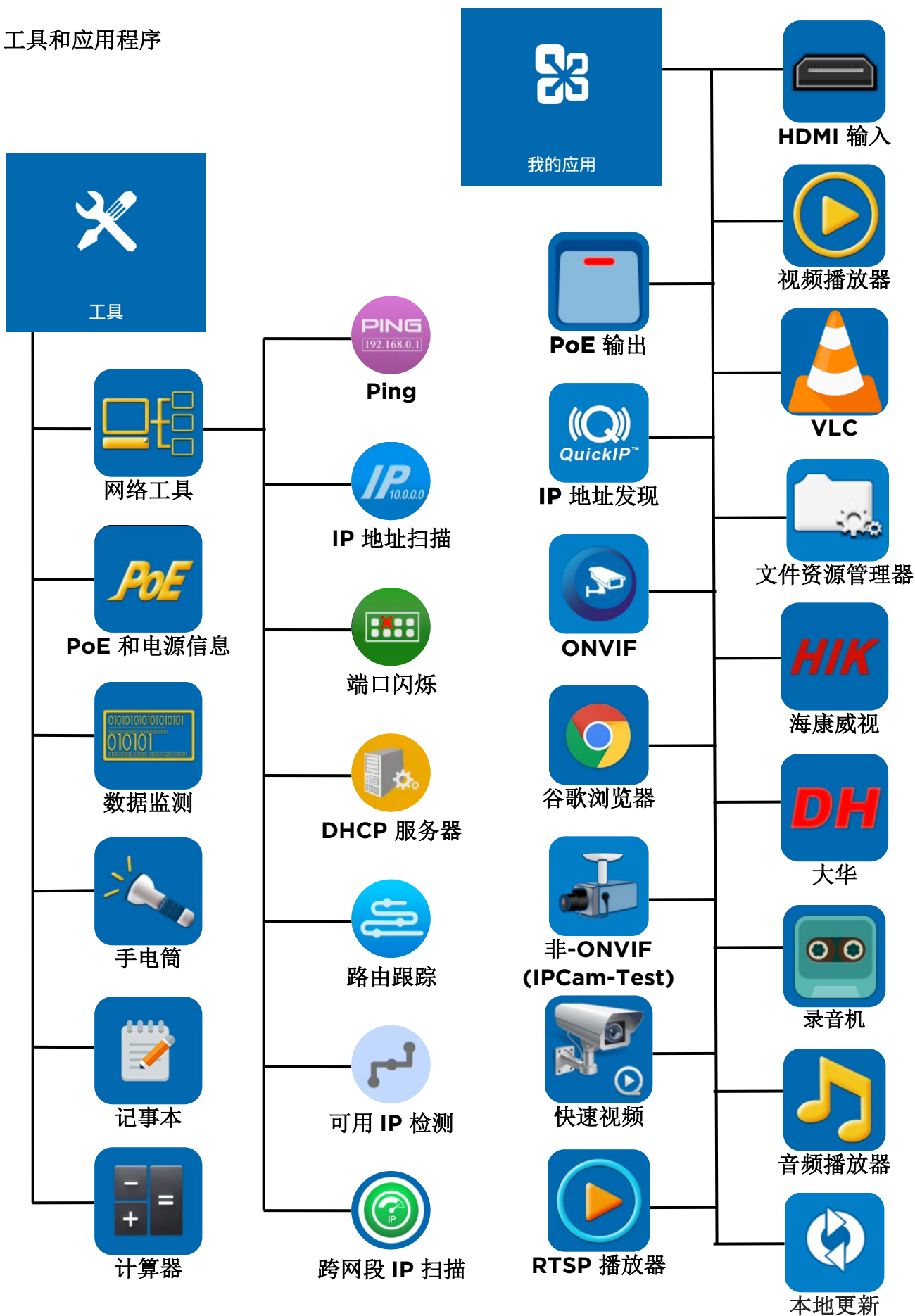

中文

设置和其他

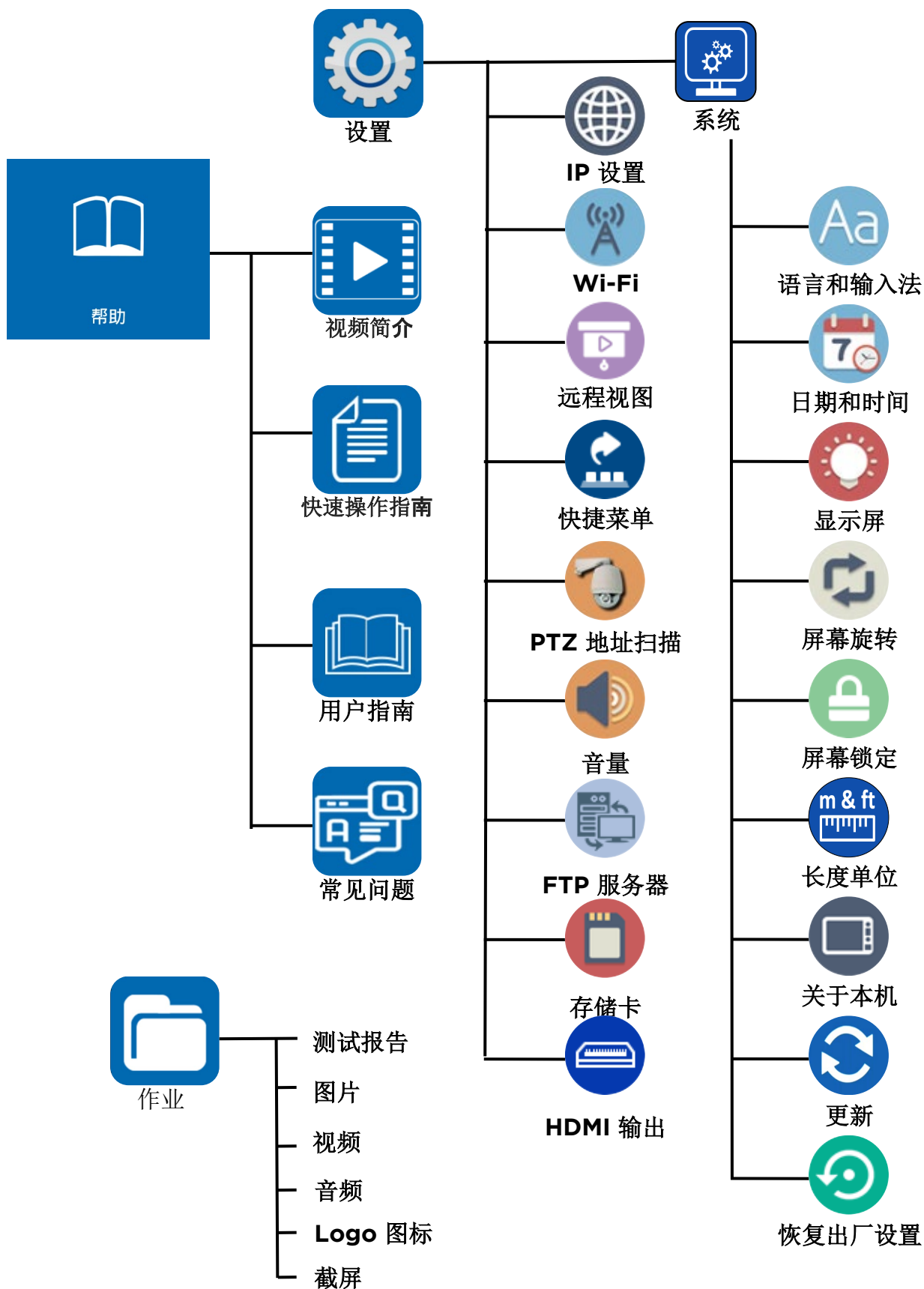

中文

English

Français

Deutsch

Italiano

Español

Português

中文



TREND NETWORKS
Stokenchurch House, Oxford Road, Stokenchurch,
High Wycombe, Bucks, HP14 3SX, UK.
www.trend-networks.com