

# Quick Start Guide



## GV-SNVR System

*The Vision of Security*



Thank you for purchasing GV-SNVR. This guide is designed to assist the new user in getting immediate results from the GV-SNVR. For advanced information on how to use the GV-SNVR, please refer to *GV-SNVR User's Manual*.



© 2021 GeoVision, Inc. All rights reserved.

Under the copyright laws, this manual may not be copied, in whole or in part, without the written consent of GeoVision.

Every effort has been made to ensure that the information in this manual is accurate. GeoVision, Inc. makes no expressed or implied warranty of any kind and assumes no responsibility for errors or omissions. No liability is assumed for incidental or consequential damages arising from the use of the information or products contained herein. Features and specifications are subject to change without notice.

**Note:** No memory card slot or local storage function for Argentina.

GeoVision, Inc.  
9F, No. 246, Sec. 1, Neihu Rd.,  
Neihu District, Taipei, Taiwan  
Tel: +886-2-8797-8377  
Fax: +886-2-8797-8335  
<http://www.geovision.com.tw>

Trademarks used in this manual: *GeoVision*, the *GeoVision* logo and GV series products are trademarks of GeoVision, Inc. *Windows* is the registered trademark of Microsoft Corporation.

March 2021

# Contents

<b>1. Introduction</b>	<b>1</b>
1.1 Packing List	1
1.1.1 Single Package	2
1.1.2 Bundled Package for GV-SNVR0400F	5
1.2 Compatible Products and System Requirements	6
1.2.1 Supported GV-IP Cameras	6
1.2.2 Supported GeoVision Applications	8
1.2.3 System Requirements	9
1.3 Optional Accessories	9
<b>2. Overview</b>	<b>10</b>
2.1 GV-SNVR0411 Front View	10
2.2 GV-SNVR0411 Back View	11
2.3 GV-SNVR0400F Front View	12
2.4 GV-SNVR0400F Back View	13
2.5 GV-SNVR0811 Front View	14
2.6 GV-SNVR0811 Back View	15
2.7 GV-SNVR0412 / 0812 Front View	16
2.8 GV-SNVR0412 / 0812 Back View	17
2.9 GV-SNVR1600 Front View	18
2.10 GV-SNVR1600 Back View	19
2.11 GV-SNVR1611 Front View	20
2.12 GV-SNVR1611 Back View	21
<b>3. Installation</b>	<b>22</b>
3.1 GV-SNVR0411	22
3.2 GV-SNVR0811	24
3.3 GV-SNVR0400F	26
3.4 GV-SNVR1600	28
3.5 GV-SNVR1611	30
3.6 GV-SNVR0412 / 0812	31
<b>4. Connecting the GV-SNVR</b>	<b>33</b>
4.1 Network Connection for GV-SNVR1600	37
4.2 Accessing the GV-SNVR	38
<b>5. Connecting to GV-IP Cameras</b>	<b>39</b>
<b>6. Formatting Hard Drive</b>	<b>41</b>
<b>7. Main Screen</b>	<b>42</b>

7.1	Enabling Recording .....	43
7.2	Playing Back Video.....	43
7.3	Live Monitoring .....	43
<b>8.</b>	<b>Remotely Accessing Live View.....</b>	<b>44</b>
<b>9.</b>	<b>Upgrading Firmware .....</b>	<b>45</b>

# 1. Introduction

## 1.1 Packing List

You can choose to purchase a GV-SNVR package or a bundled package which includes 4 GV-Target IP Camera of your choice and a GV-PoE switch.

Package Options:

- Single Package for GV-SNVR0400F
- Single Package for GV-SNVR0411
- Single Package for GV-SNVR0412
- Single Package for GV-SNVR0811
- Single Package for GV-SNVR0812
- Single Package for GV-SNVR1600
- Single Package for GV-SNVR1611
- Bundled Package for GV-SNVR0400F

### 1.1.1 Single Package

#### GV-SNVR0400F



1. GV-SNVR0400F
2. AC Power Cord
3. AC/DC Adapter (DC 19V, 3.42A, 65 W)
4. Screw x 6 (for HDD)
5. SATA cable
6. Download Guide
7. Quick Start Guide
8. Warranty Card

#### GV-SNVR0411



1. GV-SNVR0411
2. AC Power Cord
3. AC/DC Adapter (DC 52V, 1.38 A, 72 W)
4. SATA Cable
5. HDD Power Cable
6. Screw x 4 (for HDD)
7. Rubber Foot x 4 (for HDD)
8. USB Mouse
9. Download Guide
10. Warranty Card

## GV-SNVR0412



1. GV-SNVR0412
2. AC Power cord
3. AC/DC adapter  
(DC 48 V, 1.35 A, 65 W)
4. SATA cable
5. HDD power cable
6. Screw x 4 (for HDD)
7. USB mouse
8. Foam foot
9. Rack mount kit (2 L-shaped  
brackets + 4 screws)
10. Download Guide
11. Warranty Card

## GV-SNVR0811



1. GV-SNVR0811
2. AC Power cord
3. AC/DC Adapter  
(DC 56V, 2.32 A, 130 W)
4. SATA Cable
5. HDD Power Cable
6. Screw x 4 (for HDD)
7. USB Mouse
8. Download Guide
9. Warranty Card

## GV-SNVR0812



1. GV-SNVR0812
2. AC power cord
3. AC/DC adapter (DC 52V, 1.8A, 100W)
4. SATA cable
5. HDD power cable
6. Screw x 4 (for HDD)
7. Foam foot
8. USB mouse
9. Rack mount kit (2 L-shaped brackets + 4 screws)
10. Download Guide
11. Warranty Card

## GV-SNVR1600



1. GV-SNVR1600
2. AC Power Cord
3. SATA Cable x 4
4. HDD Mounting Bracket Kit (4 pairs and 32 screws included)
5. Rack Mount (2 L-shaped brackets and 6 screws included)
6. Rubber Foot x 4
7. USB Mouse
8. Download Guide
9. Quick Start Guide
10. Warranty Card



## GV-SNVR1611



1. GV-SNVR1611
2. AC power cord
3. SATA cable x 2
4. HDD power cable x 2
5. Screw x 8 (for HDD)
6. Foam foot
7. USB mouse
8. Download Guide
9. Warranty card

### 1.1.2 Bundled Package for GV-SNVR0400F



1. GV-SNVR400F Package x 1
2. Target IP Camera x 4
3. GV-POE0400 x 1

---

**Note:** For the Target IP Camera, select any 4 models from GV-EBL1100 / 2100, GV-EBX2100, GV-EDR1100, GV-EFD1100 / 2100. Contact your dealer for more information.

---

## 1.2 Compatible Products and System Requirements

### 1.2.1 Supported GV-IP Cameras

The GV-SNVR is compatible with the following GV-IP Cameras:

- GV-Target Series IP Cameras (Firmware V1.0 or later)
- GV-SD220/220-S (Firmware V1.04 or later)
- GV-UNFE2503 / UNP2500 (Firmware V2.11 or later)
- All other GV-IP Cameras **EXCEPT** for the models below:

GV-SNVR System	Not Supported Models
SNVR0400F	<ul style="list-style-type: none"> <li>• GV-ABD1300</li> <li>• GV-ABL Series / ADR Series / AVD Series / EBD Series / TBL Series / TDR Series / TVD Series</li> <li>• GV-BX110/12201</li> <li>• GV-BL110</li> <li>• GV-EBL2101 / 2111 / 3101 (conditionally supported) (*Note4)</li> <li>• GV-FD8700-FR</li> </ul>
SNVR1600	<ul style="list-style-type: none"> <li>• GV-FER12203 / 12700</li> <li>• GV-Fisheye Cameras (conditionally supported) (*Note3)</li> <li>• GV-MFD110</li> <li>• GV-PT110</li> <li>• GV-PTZ010D</li> <li>• GV-SD010 / 200 / 200-S / 2301 / 2322-IR / 2411 / 2722-IR / 3732-IR</li> <li>• GV-VD8700</li> <li>• GV-VR360</li> </ul>
SNVR0411	<ul style="list-style-type: none"> <li>• GV-BX110</li> <li>• GV-BL110</li> <li>• GV-FE520 / 521</li> <li>• GV-FER12203 / 12700</li> <li>• GV-MFD110</li> <li>• GV-PT110</li> <li>• GV-PTZ010D</li> <li>• GV-SD010</li> </ul>
SNVR0412	
SNVR0811	
SNVR0812	
SNVR1611	

---

**Note:** The live view of GV-SD200 / 200-S / 2411 / 2322-IR / 3732-IR can be accessed through GV-SNVR0411 / 0811, but their PTZ control functions are only available on GV-SNVR0411 firmware V2.61 or later / GV-SNVR0811 firmware V2.50 or later.

---

---

**IMPORTANT:**

1. The GV-SNVR supports the recording frame rate of up to 30 fps only.
  2. GV-SNVR supports a total bandwidth of up to 50 Mbps for GV-SNVR0400F, 40 Mbps for GV-SNVR0411, 24 Mbps for GV-SNVR0412, 80 Mbps for GV-SNVR0811, 48 Mbps for GV-SNVR0812, 100 Mbps for GV-SNVR1600 and 320 Mbps for GV-SNVR1611.
  3. GV-SNVR1600 can only connect to GV-Fisheye Cameras, except for GV-FER12203 / 12700, via **channel 1** and does not support fisheye dewarping (\*).
  4. GV-EBL2101 / 2111 / 3101 is only supported on channel 1 of GV-SNVR0400F (\*).
  5. Fisheye dewarping is only supported by GV-SNVR0411 / 0412 / 0811 / 0812. For details, see *2.8.5 Fisheye Dewarping*. **GV-SNVR1611 V3.11** only supports fisheye dewarping on GV-SNVR Viewer (V1.5.0001).
  6. For all models except GV-SNVR0400F / 1600, only connect GV-SNVR to the Internet through its WAN Port as opposed to any of the PoE ports, as they are only for connecting to IP cameras and have limited network connection.
  7. For supported IP camera, the resolutions of stream 1 and 2 both must meet the requirements noted in *Appendix C* in *GV-SNVR User's Manual*.
-

## 1.2.2 Supported GeoVision Applications

GV-SNVR is compatible with the following applications:

### For GV-SNVR0411 / 0811

- GV-Edge Recording Manager (Windows Version V1.2.0.0 or later)
- GV-Control Center (V3.4.0.0 or later)
- GV-Center V2 (V15.10 or later)
- GV-Vital Sign Monitor (V15.10 or later)
- GV-Eye (V2.3 or later)
- GV-Cloud Center (V1.0 or later)

### For GV-SNVR0412 / 0812

- GV-Edge Recording Manager (Windows Version V1.4.0.3 / 1.4.0.0 or later for GV-SNVR0412 / 0812)
- GV-Control Center (V3.6.0 or later)
- GV-Center V2 (V18.2 + [patch](#) or later)
- GV-Vital Sign Monitor (V17.1 or later)
- GV-Eye (for iOS / Android V2.7.2 or later)
- GV-Cloud Center (V1.0 or later)

### For GV-SNVR1611

- GV-Center V2 (V18.2 + [patch](#) or later)
- GV-Vital Sign Monitor (V16.11 or later)
- GV-Eye (V2.5.1 or later)
- GV-Cloud Center (V1.0 or later)

### For GV-SNVR0400F / 1600

- GV-Edge Recording Manager (Windows Version V1.1.0.0 or later)
- GV-Control Center (V3.3.0.0 or later)
- GV-Center V2 (V15.10 or later)
- GV-Vital Sign Monitor (V15.10 or later)
- GV-Eye (V2.0 or later)

## 1.2.3 System Requirements

### Recommended Hard Disks

GV-SNVR0411 / 0811 supports 1 SATA HDD (3.5") with up to 8 TB capacity, GV-SNVR0400F and GV-SNVR1600 supports 1 and 4 SATA HDD (3.5") with 4 and 16 TB capacities, respectively, GV-SNVR0412 / 0812 and GV-SNVR1611 support 1 and 2 SATA HDD (3.5") with 10 and 20 TB capacities, respectively. For system efficiency, it is recommended to use **enterprise-level hard disk** drives instead of desktop-level or green HDD. For tested hard disk drives, see *Appendix* in [GV-SNVR User's Manual](#).

---

**Note:** The GV-SNVR does not support the 2.5" SATA HDD.

---

### Supported Web Browsers

- Internet Explorer 8 or later (10 or later for GV-SNVR0412 / 0812)
- Google Chrome
- Mozilla Firefox
- Safari (Only supported by GV-SNVR0411 / 0412 / 0811 / 0812 / 1611)
- Microsoft Edge (Only supported by GV-SNVR0411 / 0412 / 0811 / 0812 / 1611)

## 1.3 Optional Accessories

Optional devices can expand your GV-SNVR's capabilities and versatility. Contact your dealer for more information.

Options	Description
<b>GV-Joystick V2</b>	GV-Joystick V2 facilitates PTZ camera control. It can be plugged into the GV-SNVR for independent use to empower the operation of PTZ cameras.
<b>GV-POE Switch</b>	GV-POE Switch is designed to provide power along with network connection for IP devices. GV-POE Switch is available in various models with different numbers and types of ports.
<b>GV-WiFi Adaptor V2</b>	For GV-SNVR0411 / 0811 only, GV-WiFi Adaptor V2 is designed to connect GV IP devices to a wireless network. This product supports 2.4 GHz and 5 GHz wireless connection.
<b>Slide Rail Kit (for GV-SNVR1600 only)</b>	The Slide Rail Kit is used to mount a rail for the GV-SNVR1600 in a 19" cabinet.

## 2. Overview

### 2.1 GV-SNVR0411 Front View

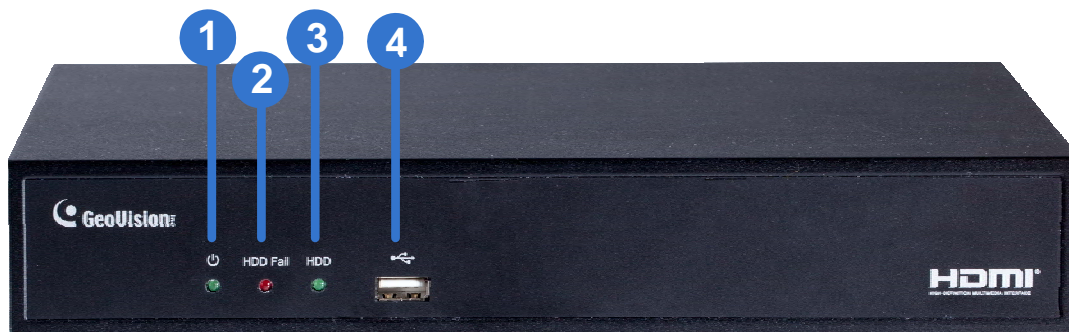

No.	Name	Function
1	Power LED	Shows constant Green when the power is supplied for the device.
2	HDD Error LED	Shows constant red when: <ul style="list-style-type: none"> <li>No hard drive is installed.</li> <li>The hard drive is not formatted.</li> <li>The hard drive fails.</li> </ul>
3	HDD LED	Blinks Green when the HDD is writing or reading data.
4	USB 2.0 Port	Connects to a keyboard, mouse, USB flash drive, GV-WiFi Adaptor V2 or GV-Joystick V2

## 2.2 GV-SNVR0411 Back View



No.	Name	Function
1	DC 52 V (Power Input)	Connects to power supply.
2	Megabit PoE Port	Connects to cameras, delivering power and network connection to the cameras.
3	WAN	Connects to the network.
4	USB 2.0 Port	Connects to a keyboard, mouse, USB flash drive, GV-WiFi Adaptor V2 or GV-Joystick V2.
5	Default Button	Restores the device to default settings. Press the button for 15 seconds to load default.
6	HDMI Output	Connects to a HD TV.

**IMPORTANT:** Only connect GV-SNVR0411 to the Internet through its **WAN Port** (No. 3), as opposed to any of the 4 PoE ports (No. 2), as they are only for connecting to IP cameras and have limited network connection.

## 2.3 GV-SNVR0400F Front View

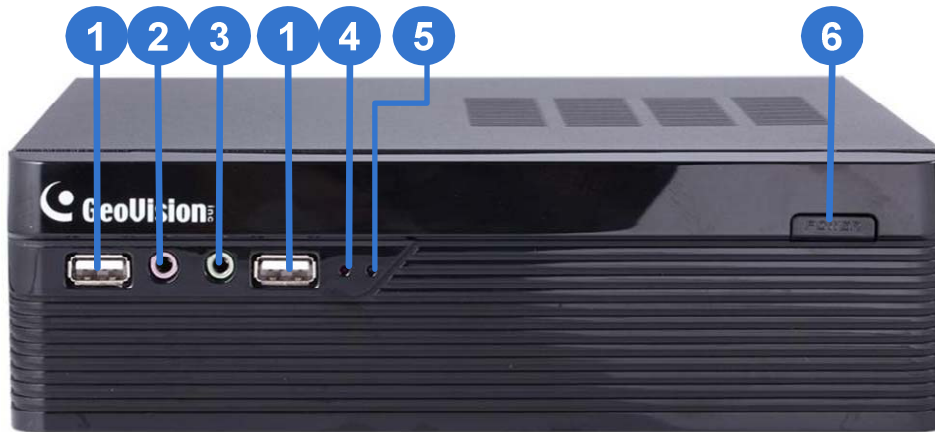

No.	Name	Function
1	USB 2.0 Port	Connects to keyboard, mouse, USB flash drive or GV-Joystick V2.
2	Audio In	Not functional.
3	Audio Out	Connects to speaker.
4	Power LED	Shows constant blue when the power is supplied for the device.
5	HDD Error LED	Shows constant red when: <ul style="list-style-type: none"> <li>No hard drive is installed.</li> <li>The hard drive is not formatted.</li> <li>The hard drive fails.</li> </ul>
6	Power Button	Turns on/off the power.



## 2.4 GV-SNVR0400F Back View



No.	Name	Function
1	Gigabit Ethernet Port	Connects to the network.
2	HDMI Output	Connects to the HD TV.
3	USB 2.0 Port	Connects to keyboard, mouse, USB flash drive or GV-Joystick V2.
4	Default Button	Restores the device to default settings. Press the button for 15 seconds to load default.
5	Power Input	Connects to power supply.

## 2.5 GV-SNVR0811 Front View



No.	Name	Function
1	Power LED	Shows constant Green when the power is supplied for the device.
2	HDD Error LED	Shows constant red when: <ul style="list-style-type: none"> <li>No hard drive is installed.</li> <li>The hard drive is not formatted.</li> <li>The hard drive fails.</li> </ul>
3	HDD LED	Blinks Green when the HDD is writing or reading data.
4	PoE LED	Indicates the PoE port in use.

## 2.6 GV-SNVR0811 Back View

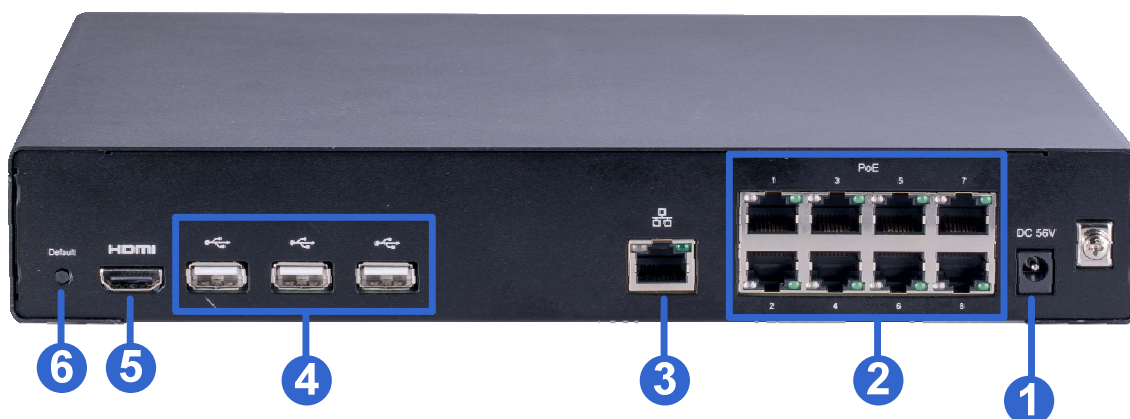

No.	Name	Function
1	DC 52 V (Power Input)	Connects to power supply.
2	Megabit PoE Port	Connects to cameras, delivering power and network connection to the cameras.
3	Network	Connects to the network. The light on the left turns orange when connecting to Ethernet of 10 /100 Mbps.
4	USB 2.0 Port	Connects to a keyboard, mouse, USB flash drive, GV-WiFi Adaptor V2 or GV-Joystick V2.
5	HDMI Output	Connects to a HD TV.
6	Default Button	Restores the device to default settings. Press the button for 15 seconds to load default.

**IMPORTANT:** Only connect GV-SNVR0811 to the Internet through its **WAN Port** (No. 3), as opposed to any of the 8 PoE ports (No. 2), as they are only for connecting to IP cameras and have limited network connection.

## 2.7 GV-SNVR0412 / 0812 Front View

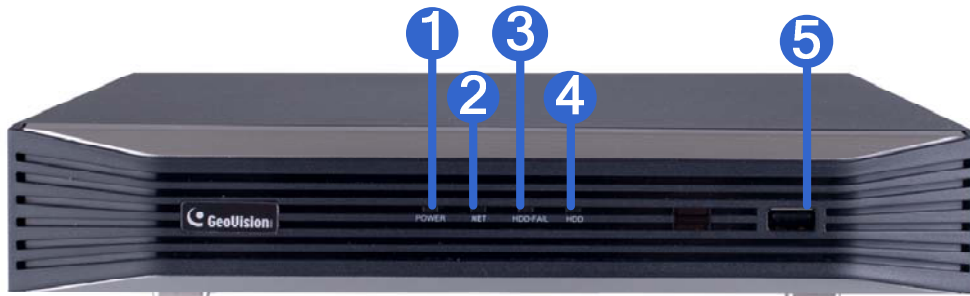

No.	Name	Function
1	Power LED	Shows constant blue when power is supplied.
2	Network LED	Shows constant blue when connected to a network.
3	HDD Fail LED	Shows constant red when the hard drive is either: <ul style="list-style-type: none"> <li>• Not formatted.</li> <li>• Fails to read or write.</li> </ul>
4	HDD LED	Shows constant blue when the hard drive is writing or reading data.
5	USB 2.0 Port	Connects to a keyboard, mouse, USB flash drive or GV-Joystick V2.

## 2.8 GV-SNVR0412 / 0812 Back View

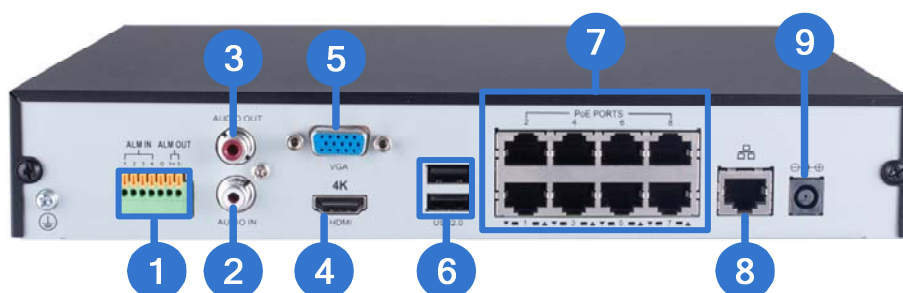

No.	Name	Function
1	I/O Panel	Connects to 4 input and 1 output devices
2	Audio Line Out Port	Connects to a speaker.
3	Audio Line In Port	Connects to a microphone.
4	HDMI Output	Connects to a HD TV.
5	VGA Output	Connects to a VGA monitor.
6	USB 2.0 Port	Connects to a keyboard, mouse, USB flash drive or GV-Joystick V2.
7	Megabit PoE Ports	Connects to cameras, delivering power and network connection to the cameras. <ul style="list-style-type: none"> <li>• 4 ports for GV-SNVR0412</li> <li>• 8 ports for GV-SNVR0812</li> </ul>
8	Megabit Ethernet Port (WAN)	Connects to the network. The light at the bottom flashes green when connecting to Ethernet of 10 /100 Mbps.
9	DC Power Input	Connects to power supply <ul style="list-style-type: none"> <li>• 48 V for GV-SNVR0412</li> <li>• 52 V for GV-SNVR0812</li> </ul>

**IMPORTANT:** Only connect GV-SNVR0412 / 0812 to the Internet through its **WAN Port** (No. 8), as opposed to any of the 4 / 8 PoE ports (No. 7), as they are only for connecting to IP cameras and have limited network connection.

**Note:**

1. IP cameras connected to the PoE ports are provided network connection via an isolated network that is not bridged to, or inaccessible by, the WAN.
2. IP cameras connected to the PoE ports are assigned a channel number in accordance to the PoE port number.
3. GV-SNVR0412 / 0812 does not have a load default button. To restore factory settings manually for firmware V1.05 / 1.10 or later, click both the left- and right-click of the mouse 10 times within 3 seconds during the startup screen, or see 3.8 System or 6.2.5 Restoring to Factory Default Settings in *GV-SNVR User's Manual* for loading default through its UI or GV-IP Device Utility, respectively.

## 2.9 GV-SNVR1600 Front View



No.	Name	Function
1	Power Button	Turns on/off the power.
2	Power LED	Shows constant blue when the power is supplied for the device.
3	HDD Status LED	Flashes blue when the hard drive is writing or reading data.
4	HDD Error LED	Shows constant red when: <ul style="list-style-type: none"> <li>No hard drive is installed.</li> <li>The hard drive is not formatted.</li> <li>The hard drive fails.</li> </ul>
5	WAN LED	Flashes blue when the WAN port is receiving activity.
6	LAN LED	Flashes blue when the LAN port is receiving activity.
7	USB 2.0 Port	Connects to keyboard, mouse, USB flash drive or GV-Joystick V2.

## 2.10 GV-SNVR1600 Back View



No.	Name	Function
1	Audio Microphone In Port	Not functional.
2	VGA Monitor Output	Connects to the VGA monitor.
3	HDMI Port	Connects to the HD TV.
4	USB 2.0 Port	Connects to keyboard, mouse, USB flash drive or GV-Joystick V2.
5	Power Input	Connects to power supply.
6	Gigabit Ethernet Port (LAN)	Connects to the network.
7	Gigabit Ethernet Port (WAN)	Connects to the network.
8	Audio Line Out Port	Connects to the headphone.
9	Audio Line Out Port	Connects to the speaker.

**Note:** When the two Ethernet ports (No. 6 and 7) are used together, one is LAN port and the other is WAN port.

## 2.11 GV-SNVR1611 Front View



No.	Name	Function
1	HDD1 LED	Constant blue when HDD1 is writing or reading data.
2	HDD2 LED	Constant blue when HDD2 is writing or reading data.
3	HDD Fail LED	Shows constant red when one or both of the hard drives is: <ul style="list-style-type: none"> <li>• Not formatted.</li> <li>• Fails to read or write.</li> </ul>
4	Power LED	Shows constant blue when power is supplied.
5	USB 2.0 Port	Connects to a keyboard, mouse, USB flash drive or GV-Joystick V2.



## 2.12 GV-SNVR1611 Back View

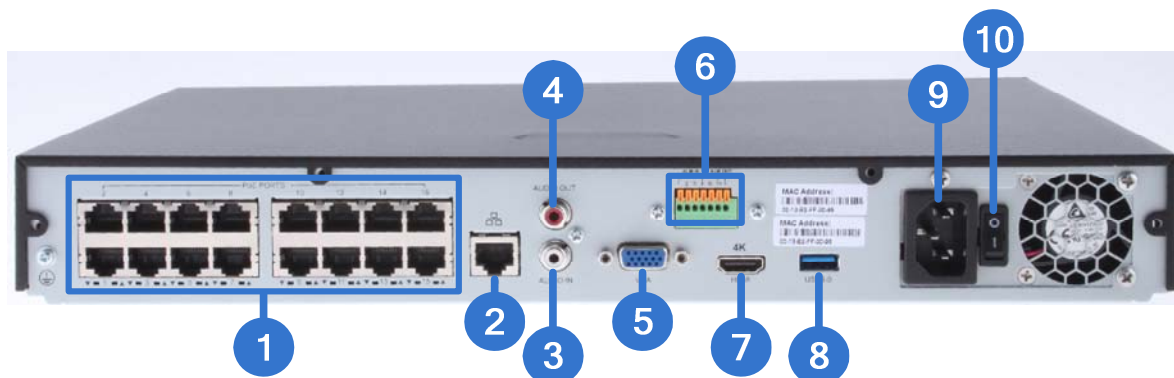

No.	Name	Function
1	Megabit PoE Ports	Connects to cameras, delivering power and network connection to the cameras.
2	Megabit Ethernet Port (WAN)	Connects to the network.
3	Audio Line In Port	Connects to a microphone.
4	Audio Line Out Port	Connects to a speaker.
5	VGA Output	Connects to a VGA monitor.
6	I/O Panel	Connects to 4 input and 1 output devices
7	HDMI Output	Connects to a HD TV.
8	USB 3.0 Port	Connects to a keyboard, mouse, USB flash drive or GV-Joystick V2.
9	Power Input	Connects to power supply.
10	Power Button	Turns the system on or off.

**IMPORTANT:** Only connect GV-SNVR1611 to the Internet through its **WAN Port** (No. 2), as opposed to any of the 16 PoE ports (No. 1), as they are only for connecting to IP cameras and have limited network connection.

**Note:** GV-SNVR1611 does not have a load default button. To restore factory settings manually for:

- Firmware V3.09 or earlier, right-click the mouse five times during the startup screen.
- Firmware V3.10 or later, click both the left- and right-click of the mouse 10 times within 3 seconds during the startup screen.

Or see [6.2.5 Restoring to Factory Default Settings, GV-SNVR User's Manual](#) for loading default via GV-IP Device Utility.

## 3. Installation

The GV-SNVR uses SATA hard drive for video data storage. Before recording, be sure to install the hard drive.

### 3.1 GV-SNVR0411

1. Unscrew three screws on the bottom and two screws on the sides; then remove the cover.

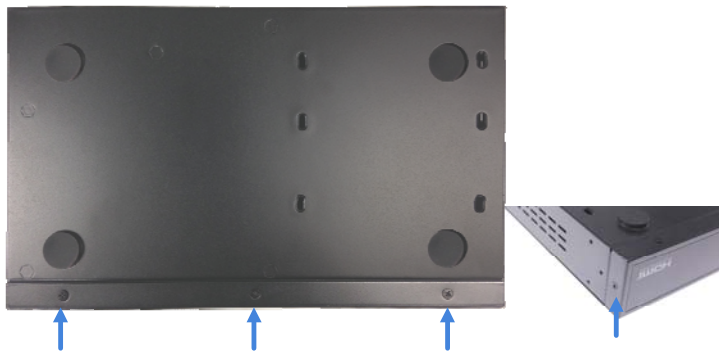

2. Place the supplied rubber feet on four of the six oval holes and place the hard drive in the drive drawer as below by aligning the four holes.

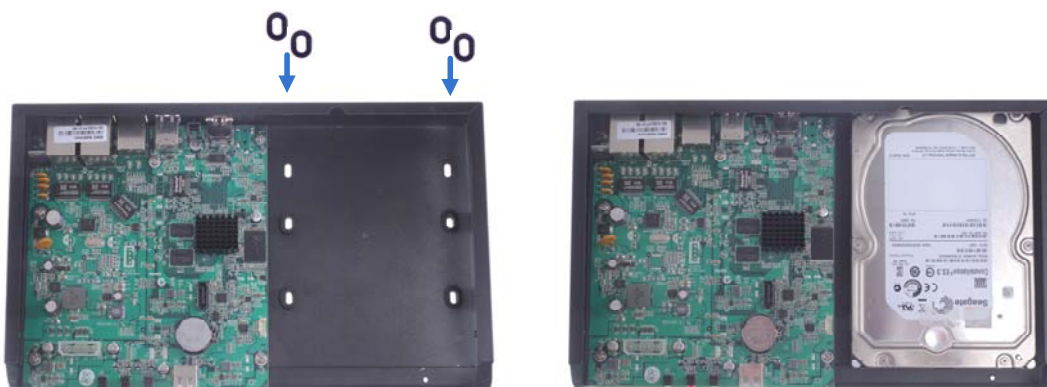

- Secure the hard drive from the back of the drawer using the 4 supplied screws.

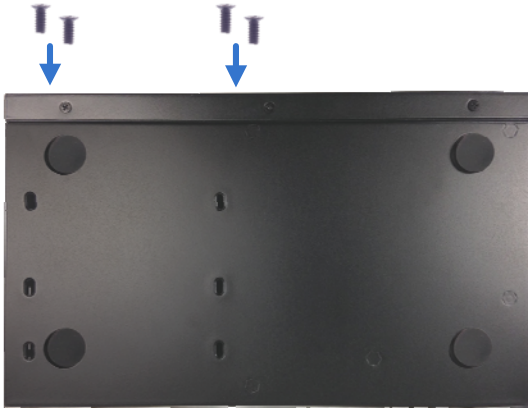

- Connect the SATA Power Cable and Data Cable to the hard drive.

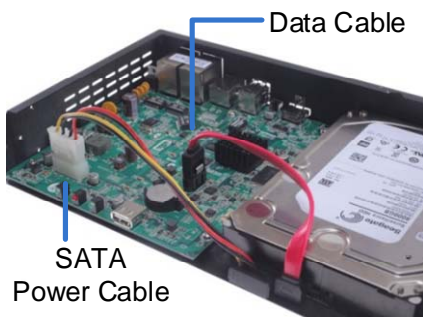

- Place the cover back and tighten the screws.

The hard drive is now ready to use.

### 3.2 GV-SNVR0811

1. Unscrew the two screws on the both sides, and remove the cover.



2. Place the hard drive in the driver drawer.

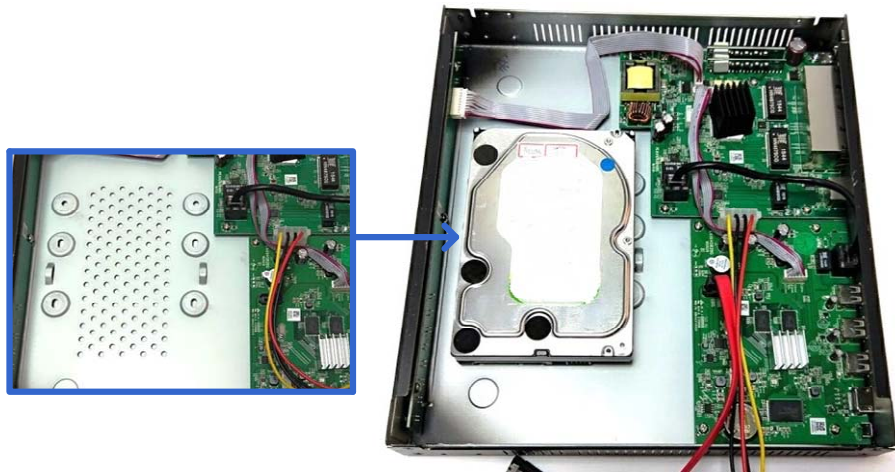

3. Secure the hard drive from the back of the drawer using the 4 supplied screws.

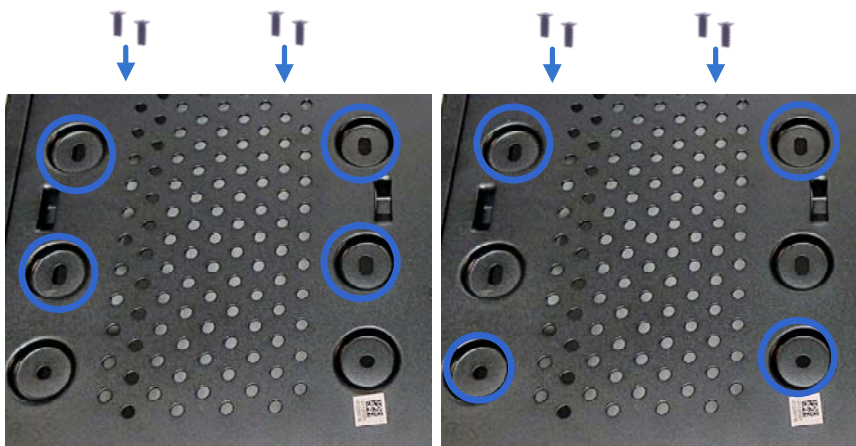

For hard drive under 4 TB

For hard drive above 4 TB

4. Connect the SATA Power Cable and Data Cable to the hard drive.

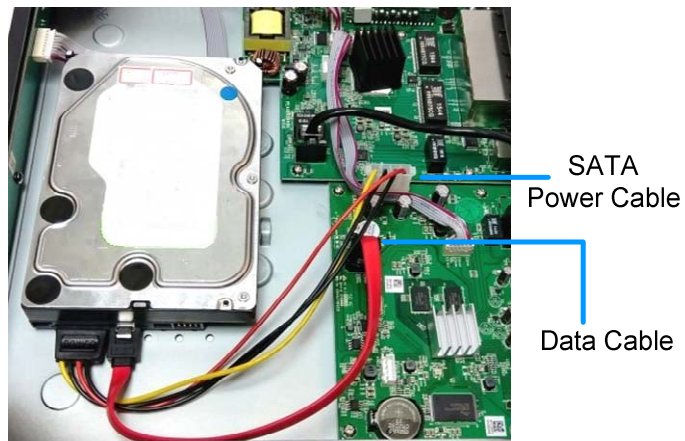

5. Assemble the cover with the device by tightening the screws on the both sides.

The hard drive is now ready to use.

### 3.3 GV-SNVR0400F

1. Unscrew the two screws on the rear panel and remove the cover.



2. Unscrew the drive drawer and take it out from the device.



3. Place the hard drive in the drive drawer as below by aligning the three holes.

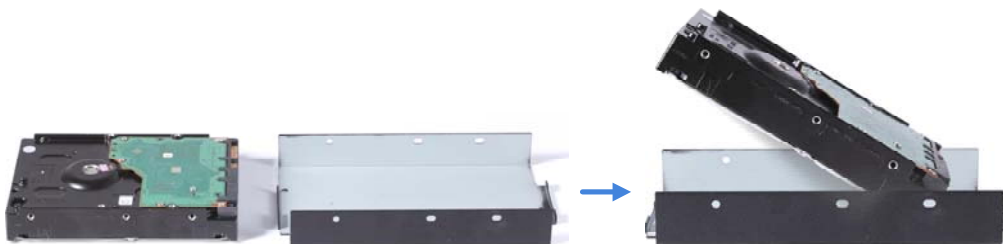

- Secure the hard drive with the drive drawer using the 6 supplied screws (3 screws on each side).

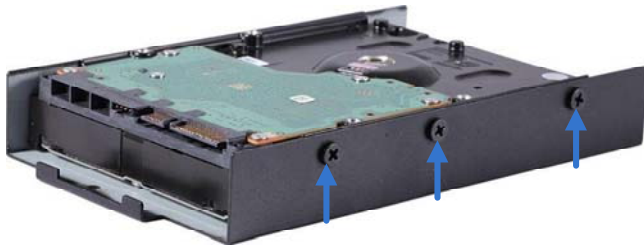

- Connect the SATA Power Cable and Data Cable to the hard drive.

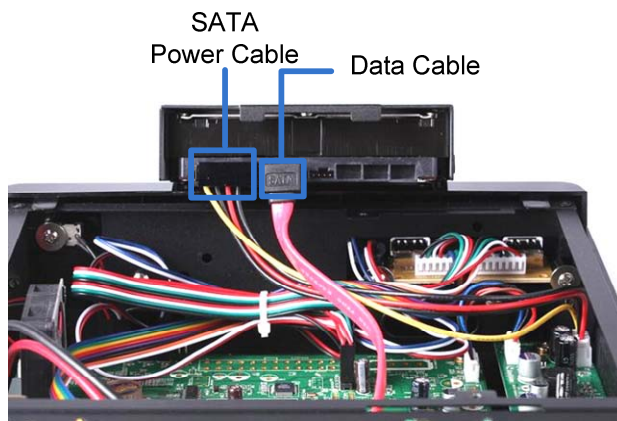

- Put the drive drawer back in the device and secure the two screws on the drive drawer. Refer to Step 2.
- Assemble the cover with the device by tightening the screws on rear panel. Refer to Step 1.

The hard drive is now ready to use.

### 3.4 GV-SNVR1600

1. Loosen the 6 screws and remove the cover.



2. Assemble the mounting brackets with the hard drive and tighten the screws on both sides.

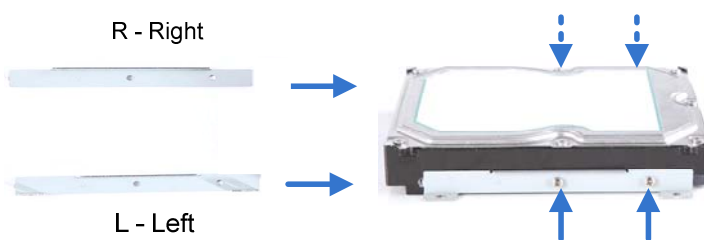

---

**Note:** Each mounting bracket is labeled **L** or **R** for recognition. Align the mounting bracket with the holes on the hard drive and make sure it is secured to the correct side.

---

3. Align the mounting bracket with the holes inside the unit.

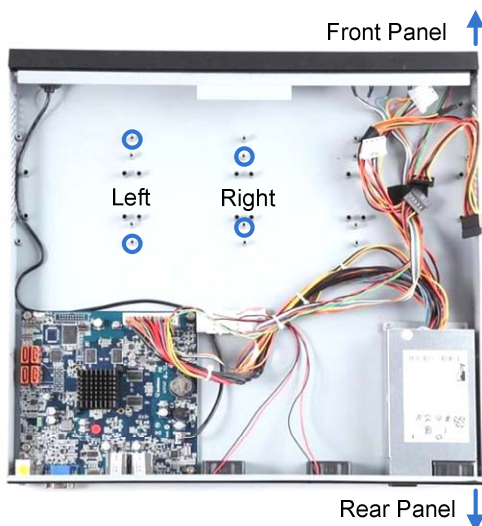



4. Tighten the 4 screws on the side of the hard drive.

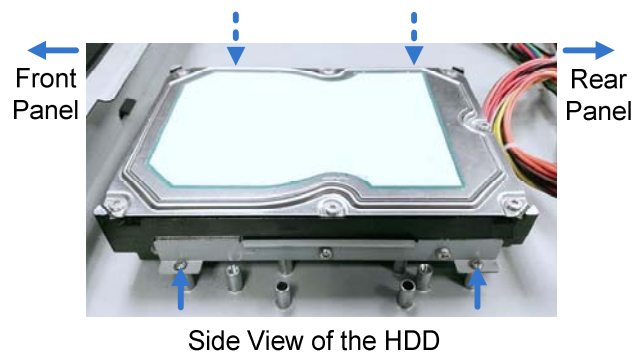

5. Connect the SATA Power Cable and Data Cable to the hard drive.

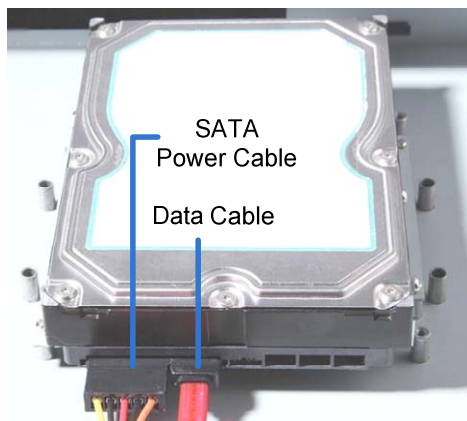

6. To install more HDDs, repeat the steps above.
7. Place the cover back and tighten the screws.

The hard drive is now ready for use.

### Installing the L-Shaped Brackets

Tighten the 6 screws to secure and attach the 2 L-shaped brackets to each side of GV-SNVR1600.



### 3.5 GV-SNVR1611

#### Installing the Hard Drive

1. Unscrew the two screws on both sides and the four screws on the rear to remove the cover.



2. Place the hard drive in the driver drawer.



3. Secure the hard drive from the back of the drawer using the 4 supplied screws.

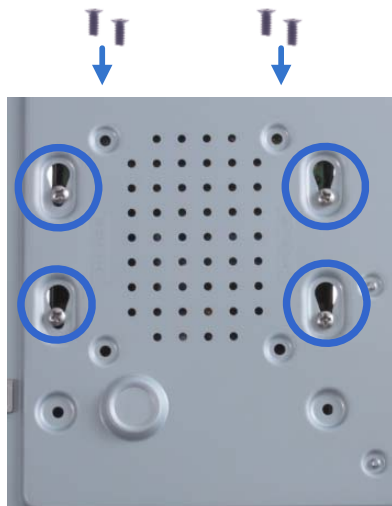

4. Connect the SATA Power Cable and Data Cable to the hard drive.



5. Assemble the cover with the device by tightening the screws on both sides and the rear side.

The hard drive is now ready for use.

## 3.6 GV-SNVR0412 / 0812

The following procedure is exemplified using GV-SNVR0812

### Installing the Hard Drive

1. Unscrew the two screws on both sides and the two screws on the rear to remove the cover.



2. Place the hard drive in the driver drawer.

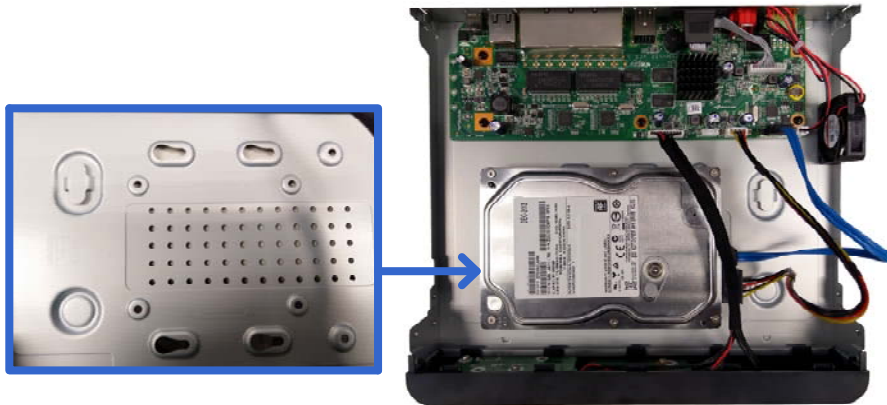

3. Secure the hard drive from the back of the drawer using the 4 supplied screws.

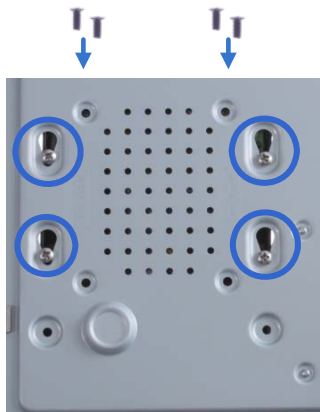

4. Connect the SATA Power Cable and Data Cable to the hard drive.

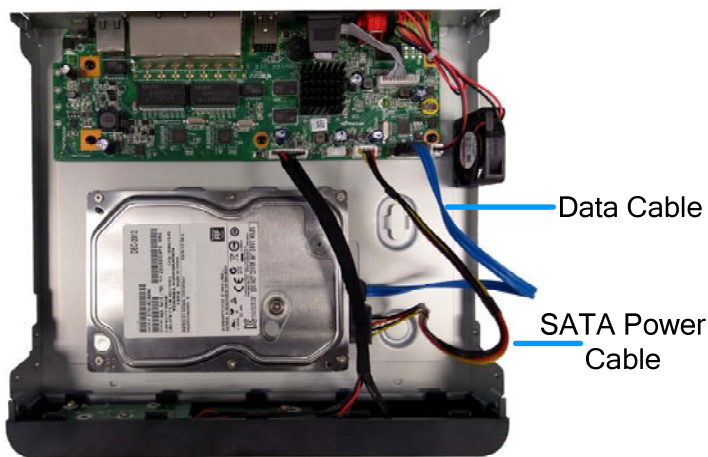

5. Assemble the cover with the device by tightening the screws on both sides and the rear side.

The hard drive is now ready for use.

## 4. Connecting the GV-SNVR

Follow the steps below to connect the GV-SNVR.



GV-SNVR0411

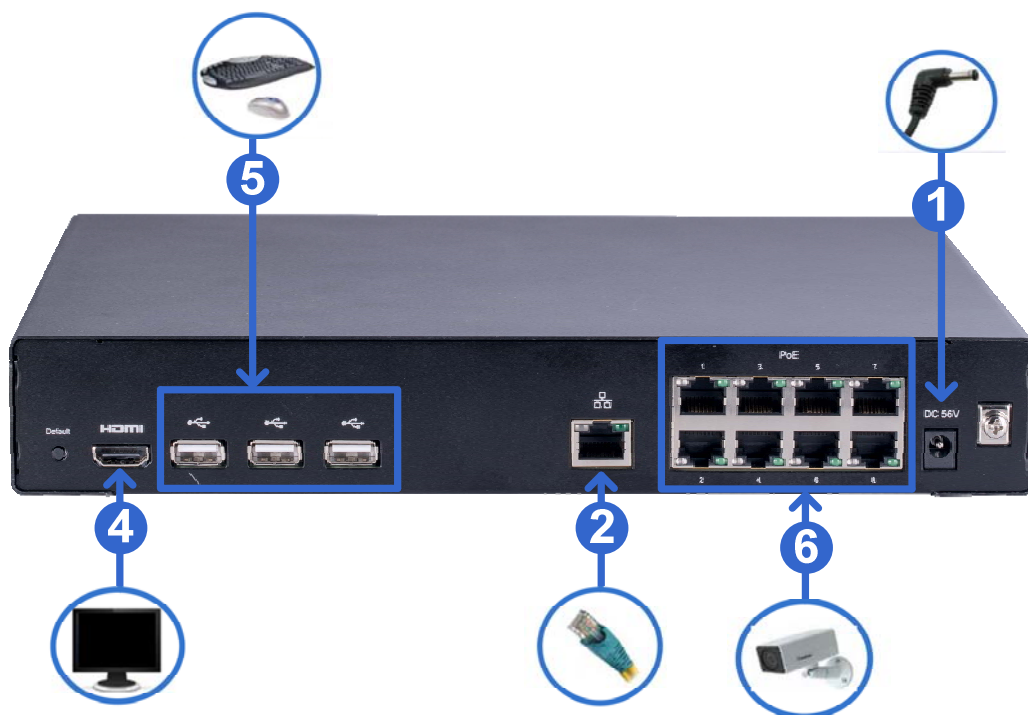

GV-SNVR0811

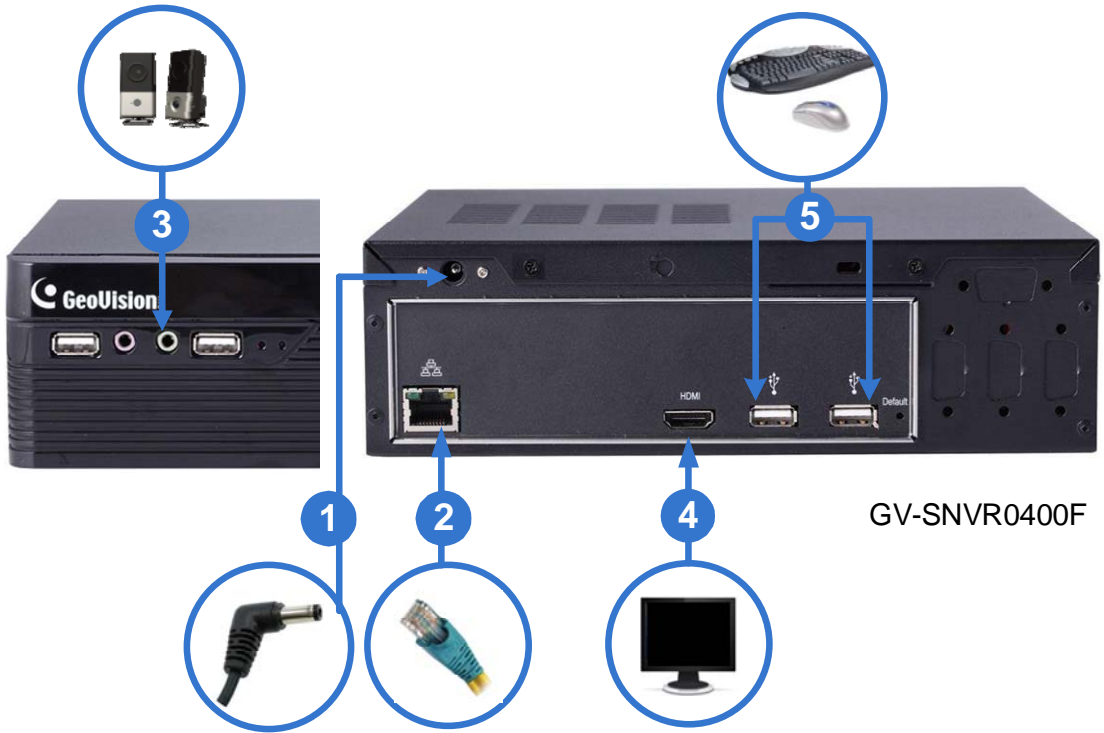

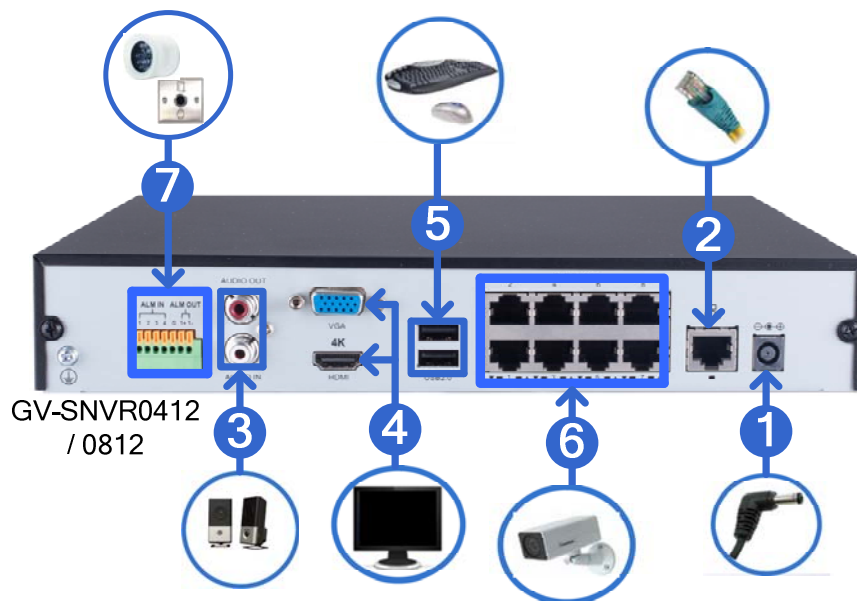
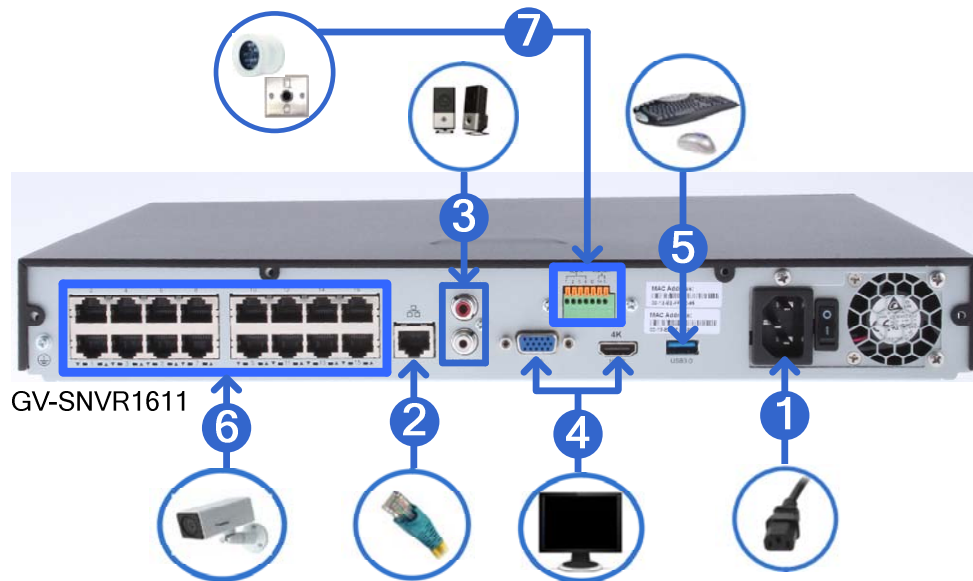

1. Connect the GV-SNVR to power.
2. Connect the GV-SNVR to the network using the Ethernet cable. For **GV-SNVR0411 / 0412 / 0811 / 0812 / 1611**, only connect to the network via its specified LAN / WAN port as illustrated.
3. Connect a speaker to the Audio Line Out port. Only for **GV-SNVR0412 / 0812 / 1611**, connect a microphone to the Audio Line In port.
4. Connect an HDTV to HDMI connector for video/audio output. Only for **GV-SNVR0412 / 0812 / 1600 / 1611**, optionally connect a VGA monitor to the D-Sub connector for dual-display.
5. Connect a mouse and/or keyboard to the USB port(s).

6. Only for **GV-SNVR0411 / 0412 / 0811 / 0812 / 1611**, connect cameras to the GV-SNVR using Ethernet cables.
7. Only for **GV-SNVR0412 / 0812 / 1611**, connect up to 4 input and 1 output devices to the GV-SNVR.

Press or switch on the power button to start the GV-SNVR.

---

**IMPORTANT:** For all models except GV-SNVR0400F /1600, only connect GV-SNVR to the Internet through its WAN port as opposed to any of the PoE ports, as they are only for connecting to IP cameras and have limited network connection.

---

---

**Note:**

1. The GV-SNVR is DHCP enabled. When it is connected to the network, it will be automatically assigned an IP address.
  2. For GV-SNVR1600, the monitor used for VGA output must be capable of having a screen resolution of 1080p. For GV-SNVR0411 / 0412 / 0811 / 0812 / 1611, when configuring the camera's video resolution to 4K, be sure your monitor is a 4K-capable monitor.
  3. It is recommended to use HDMI-certified cables. Be aware that signal instabilities may occur if the HDMI cable used exceeds a length of 10 m.
-



## 4.1 Network Connection for GV-SNVR1600

There are two network ports, LAN and WAN, for the GV-SNVR1600. If both network ports are used simultaneously, only the WAN port can be connected to the Internet. Therefore, it is recommended to connect the devices as below.

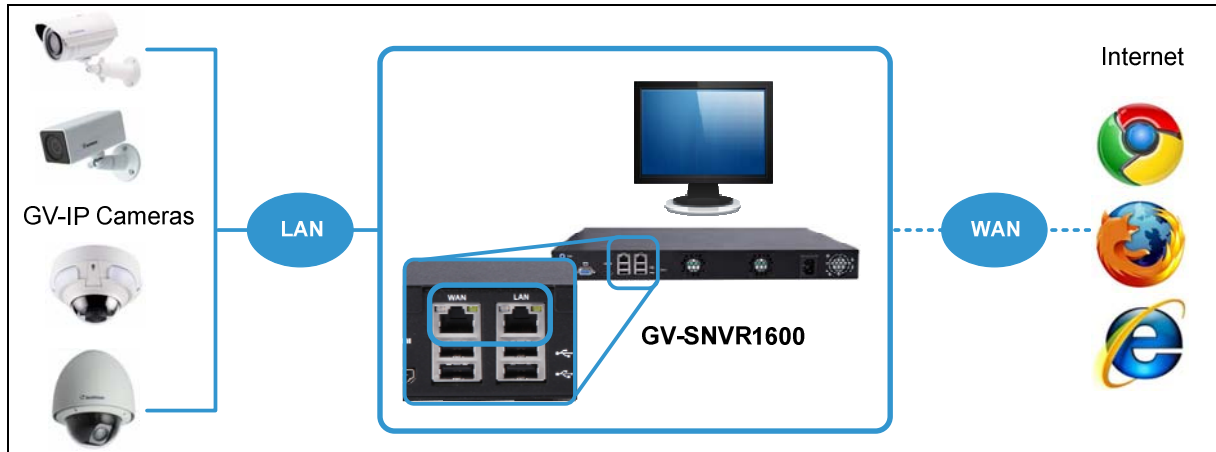

1. Connect GV-IP Cameras to the GV-SNVR1600 through the LAN port.
2. Connect GV-SNVR1600 to the Internet through the WAN port.

---

**Note:** When the LAN and WAN ports are used together, the Auto Search function is only supported by the LAN port. To connect to GV-IP Cameras under the WAN, you can add the cameras manually.

---

**IMPORTANT:** It is required to divide LAN and WAN networks into different subnets or segments; otherwise, your network will fail. For details, see *3.3 Network* in *GV-SNVR User's Manual*.

---

## 4.2 Accessing the GV-SNVR

This function is only for **GV-SNVR0411 / 0412 / 0811 / 0812 / 1611**.

When turning on the GV-SNVR for the first time or loading default settings, a login window appears. Follow the steps below to access the GV-SNVR.

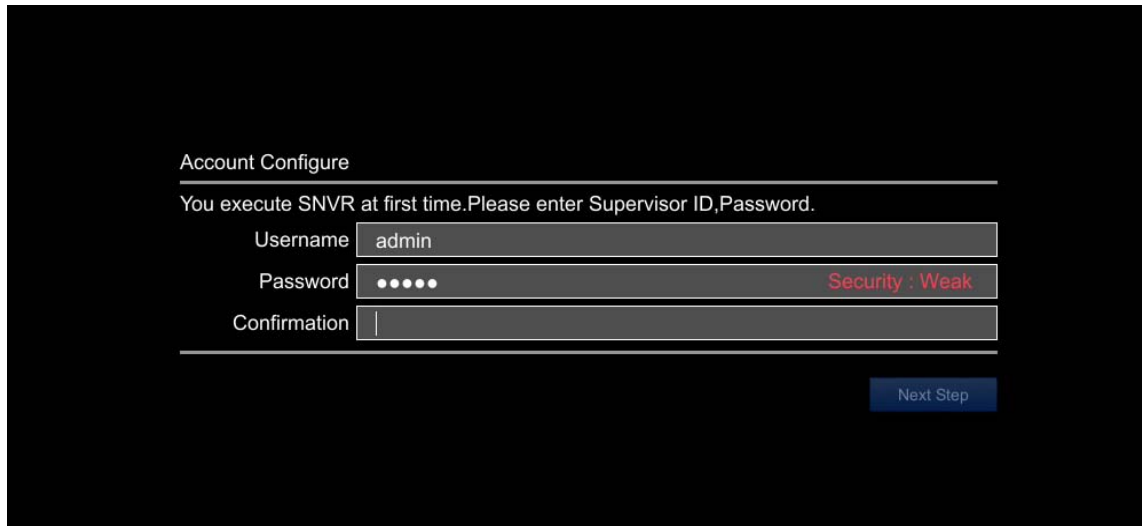

1. Type the default Username and Password: *admin* and click **Apply** to log in. You can choose to redefine the Username and Password for the GV-SNVR by typing in the desired values. Retype your new password again and click **Next Step** to log in.
2. Enable **DHCP Server** to automatically assign IP addresses for IP cameras connecting to the GV-SNVR. Click **Next Step** to continue.

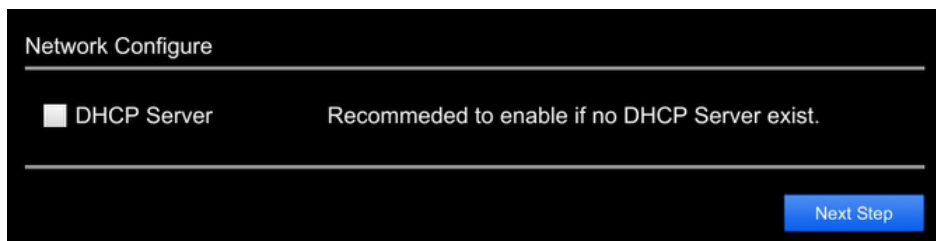

---

**Note:** For GV-SNVR0412 / 0812, any IP device connected to its PoE ports is automatically assigned an IP address by its internal, isolated DHCP server, and communicates with the network only via the SNVR.

---

## 5. Connecting to GV-IP Cameras

After you have installed the IP cameras under the same LAN as the GV-SNVR, you are ready to display the channels on GV-SNVR. To automatically set up GV-IP Cameras, see the section below. To manually add GV-IP Cameras, see *2.3.2 Manually Connecting GV-IP Cameras* in *GV-SNVR User's Manual*.

1. Upon login, the GV-SNVR automatically searches and lists the IP cameras under the same LAN.
2. For **GV-SNVR0411 / 0811 / 1611** only, you are prompted with a dialog box asking if you want to automatically assign IP address. The automatic assignment only applies to cameras with IP address **192.168.0.10**.

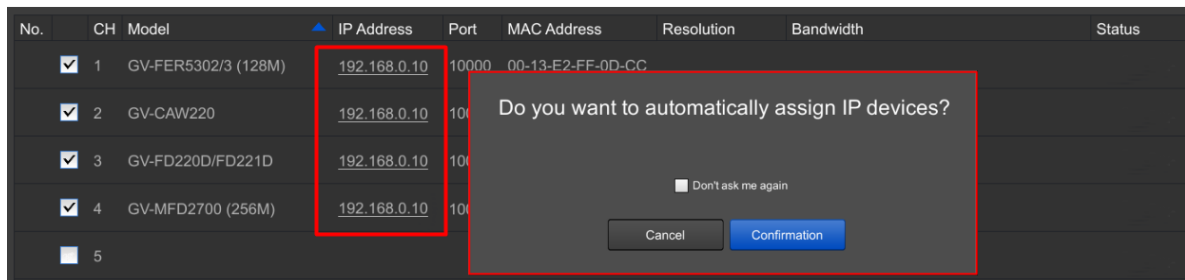

3. Click **Apply**. The GV-SNVR assigns unused IP addresses to the cameras in an ascending numerical order and enables the connection.

The screenshot shows the same table of cameras after the IP addresses have been assigned. The 'IP Address' column for the first four cameras is highlighted with a red box, showing the values '192.168.0.20', '192.168.0.30', '192.168.0.40', and '192.168.0.50' respectively.

No.	CH	Model	IP Address	Port	MAC Address	Resolution	Bandwidth	Status
<input checked="" type="checkbox"/>	1	GV-FER5302/3 (128M)	192.168.0.20	10000	00-13-E2-FF-0D-CC			
<input checked="" type="checkbox"/>	2	GV-CAW220	192.168.0.30	10000	00-13-E2-FF-04-63			
<input checked="" type="checkbox"/>	3	GV-FD220D/FD221D	192.168.0.40	10000	00-13-E2-04-D3-75			
<input checked="" type="checkbox"/>	4	GV-MFD2700 (256M)	192.168.0.50	10000	00-13-E2-FA-CD-BE			

Upon successful connection, the status displays "Connected", with the resolution and bandwidth being displayed in the corresponding columns. Close the Camera page to access the live view.

---

**Note:** For GV-SNVR1611, IP cameras detected under the same LAN are listed starting from the second page of the camera list, while the first page only displays the cameras that are connected to the SNVR.

---

**IMPORTANT:**

1. By default, GV-IP Cameras use the IP address **192.168.0.10**. The GV-SNVR will automatically assign unused IP addresses to these cameras to avoid IP address conflict with others under the same LAN.
2. For GV-SNVR0411 / 0811 / 1611, to connect to GV-ABL Series / ADR Series / AVD Series / EBD Series / TBL Series / TDR Series / TVD Series / SD2322-IR / 2722-IR / 3732-IR, UVS-ABD1300 / ABL1300 / ADR1300 and EVS-ABD1300 / ABL1300 / ADR1300, your network environment must have a DHCP server. Or, you can enable the **DHCP Server** function of GV-SNVR0411 / 0811 / 1611 to automatically assign a dynamic IP address to the cameras. For details, refer to 3.3 *Network* in *GV-SNVR User's Manual*.
3. The GV-SNVR connects to IP cameras with the default ID and password **admin**. If the IP camera uses a different ID and password, click the **Edit** icon  and type the correct login information. For GV-IP cameras without default ID and password, see 3.1.1.1 *Configuring GV-IP Cameras without Default ID and Password* in *GV-SNVR User's Manual*.



4. The total bandwidth supported varies among GV-SNVR models. For detailed specifications, refer to [GV-SNVR comparison table](#). The total bandwidth can be found on the top-right corner of the camera list.

No.	CH	Model	IP Address	Port	MAC Address	Resolution	Bandwidth	Status	Brand
<input checked="" type="checkbox"/>	1	GV-CS1320 (128M)	192.168.0.110	10000	00-13-E2-FF-1D-BA	H264:1920x1080 H264:640x360	3.6 Mbps	Connecting	GeoVision
<input checked="" type="checkbox"/>	2	GV-CR1320 (128M)	192.168.0.113	10000	00-13-E2-12-84-7A	H264:1920x1080 H264:448x252	2.3 Mbps	Connecting	GeoVision
<input checked="" type="checkbox"/>	3	GV-FD3410 (128M)	192.168.0.135	10000	00-13-E2-0A-FE-04	H264:2048x1536 H264:320x240	4.3 Mbps	Connecting	GeoVision
<input checked="" type="checkbox"/>	4	GV-EBD4711	192.168.6.236	ONVIF	00-13-E2-FA-CD-BE			Connecting	GeoVision_2

Camera Selected: 7, Total Bandwidth: 10.2 Mbps Page 1/14

## 6. Formatting Hard Drive

After installing the hard drive to GV-SNVR, you need to format the hard drive before enabling the monitoring.

1. On the main screen, click the **Setting** button.



2. Select **Storage** and click **Format**. A message appears to ask for confirmation.

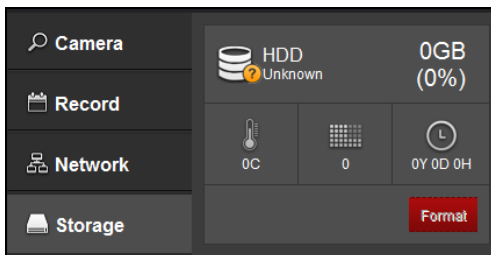

3. Click **Execute** to format the hard drive.

When the hard drive is successfully formatted, its icon should be marked with a green tick, and the word “Normal” appears.

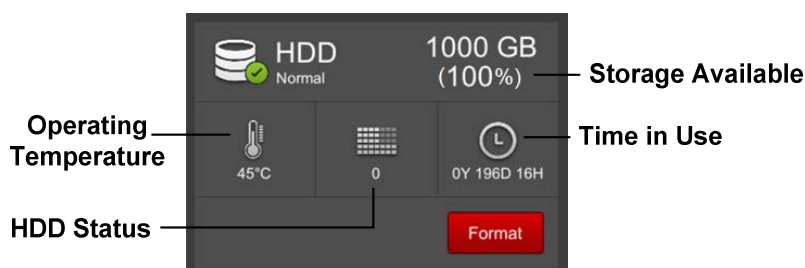

**Note:** When the hard drive status displays a value other than **0**, replace the hard drive with a new one to ensure proper video recording.

## 7. Main Screen

Close the Camera page to see the connected channels on the main screen.

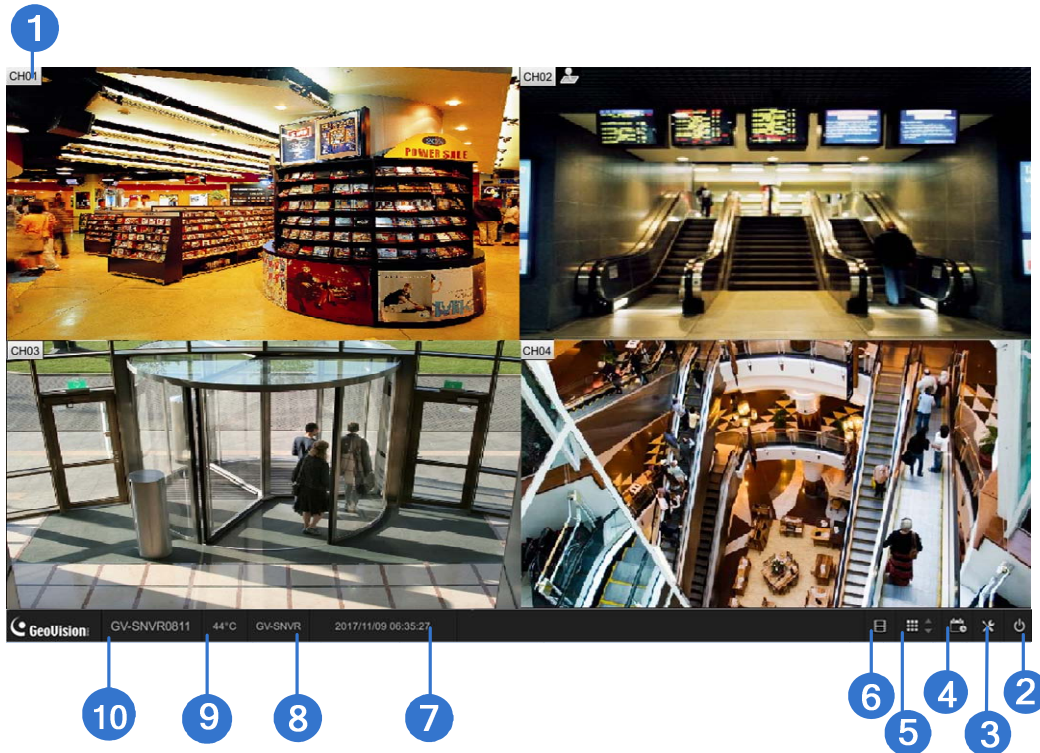

No.	Name	Description
1	Camera Name	Indicates the camera name. The column changes from gray to red when the recording is enabled.
2	System	Brings up the options: Log Out, Reboot and Shutdown.
3	Setting	Accesses the following setting pages: Camera, Recording, Network, Storage, Display, Service, Event and System. See Chapter 3 in <i>GV-SNVR User's Manual</i> for details on the setting pages.
4	Record	Starts/Stops monitoring.
5	Division & Page Up / Down	Selects screen divisions and switch between cameras in single division.
6	Playback	Displays the playback panel.
7	Date / Time	Displays the current date and time.
8	Device Name	Displays the device name of GV-SNVR. See <i>Device Name</i> in 3.7 <i>System</i> of <i>GV-SNVR User's Manual</i> .
9	Temperature	Displays the current temperature. This function is not applicable to GV-SNVR1611.
10	Model Name	Displays the model name of GV-SNVR.

## 7.1 Enabling Recording

To start recording, click the **Record** button  and select a camera. To enable recording for all the connected cameras, select **Start All Monitoring**. For details, see *2.6 Enabling Recording* in *GV-SNVR User's Manual*.

## 7.2 Playing Back Video

You can instantly play back the recorded video without interrupting the monitoring and recording.

- To instantly play back the recording of one single channel, click the **Camera Name** and select **Instant Playback**.
- To instantly play back the recording of all channels, click the **Playback** button .

For detailed instructions on playing back recordings, see *Chapter 4 Video Playback* in *GV-SNVR User's Manual*.

## 7.3 Live Monitoring

To set up the division of channel display and access the functions of snapshot, audio and PTZ control, see *2.8 Live Monitoring* in *GV-SNVR User's Manual*.

## 8. Remotely Accessing Live View

To access the live view through Web interface, follow the steps below. Here we use GV-SNVR0811 for illustration.

### For Internet Explorer:

1. Open your Web browser and type the IP address of the GV-SNVR.
2. In both Username and Password fields, type the default value **admin**.

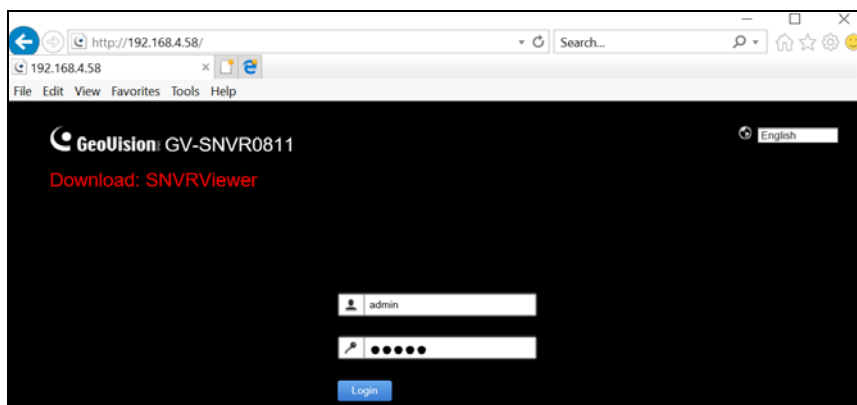

3. Select a desired language from the drop-down list at the upper-right corner of the Web interface and click **Login**.

After logging in, the Live View of the GV-SNVR is displayed.

---

### Note:

1. The maximum number of remote network connection is **10** in total for GV-SNVR0411 / 0400F / 0412, **18** in total for GV-SNVR0811 / 0812, **34** in total for GV-SNVR1600 and **51** in total for GV-SNVR1611. Every connected channel will be counted as 1 connection.
  2. To enable the update of live view on your Web browser, you must set the Web browser to allow ActiveX controls and perform a one-time installation of GeoVision's ActiveX components on your computer.
- 

### For Mozilla Firefox, Google Chrome, Safari or Microsoft Edge:

Open your Web browser, type the IP address of the GV-SNVR and download **SNVR Viewer**. For details, refer to *5.2 Accessing through SNVR Viewer* in [GV-SNVR User's Manual](#).



## 9. Upgrading Firmware

GeoVision periodically release the updated firmware on the Website. You can upgrade the firmware using a USB flash drive of FAT32 format.

To upgrade the firmware, follow the steps below.

1. Download the firmware file to a USB flash drive.
2. Connect the USB flash drive to the GV-SNVR.
3. On the main screen, click the **Setting** button  and select **System**.
4. Click the **Advanced Option** button and select **Firmware Upgrade**.
5. Find the firmware file and click **Apply**. The system starts upgrading firmware and automatically reboots after completing the process.

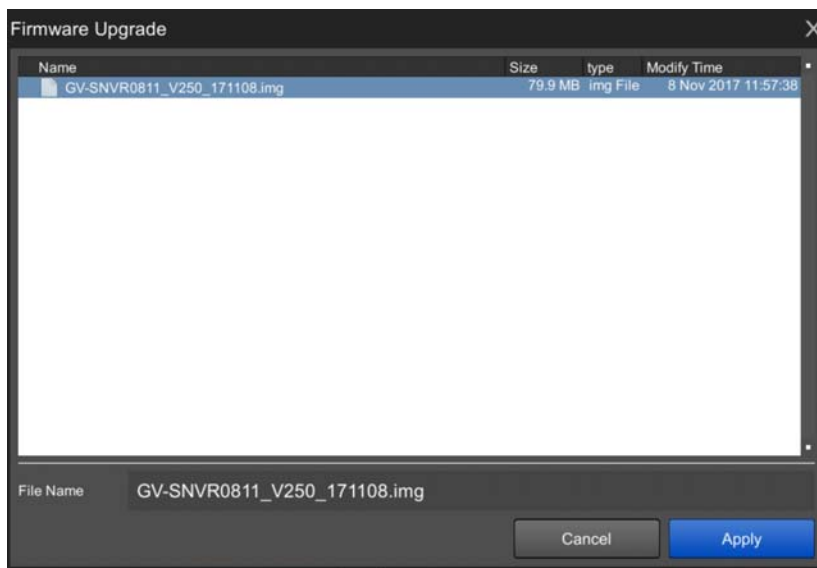

After the system reboot, the main screen will be displayed automatically.

To upgrade the firmware remotely through GV-IP Device Utility, see [6.2.3 Upgrading System Firmware](#) in [GV-SNVR User's Manual](#).