

DS-MP7508 Series Mobile Video Recorder



Features and Functions

- User-friendly GUI providing easy and flexible operations.
- Pluggable 3G/4G module and built-in Wi-Fi module providing flexible data transmission solutions.
- Supports connecting high-definition TVI camera.
- 8 analog channels of audio & video inputs connectable; each channel supports up to 1080p resolution with H.264 encoding technology.
- Information collection interfaces collecting driving information such as left/right turn, braking, reversing, etc.
- Specialized aviation connectors ensuring signal stability.
- Ignition startup and delay (0 to 6h) shutdown.
- Battery protection avoids vehicle from running out of battery.
- Wide-range power input (+ 9 to + 32 VDC).
- Power-off protection avoids key data from loss.
- Tensile aluminum chassis with no fan design well adaptable to working environment.
- Software-based firewall supported.
- GNSS (Global Navigation Satellite System) module precisely positioning the vehicle via the satellite and recording the location information in the stream.
- Stores videos on SD card when the HDD/SSD is damaged.
- Support standard 256 GB Micro SD/SDHC/SDXC card storage.
- Dummy HDD with USB interface supporting intelligent temperature control and data export.

Available Models

DS-MP7508,

DS-MP7508/GW, (Supports 3G dialing)

DS-MP7508/GW/WI, (Supports 3G dialing and 2.4G Wi-Fi)

DS-MP7508/GW/WI58, (Supports 3G dialing and 5.8G Wi-Fi)

DS-MP7508/GLF/WI, (Supports 4G dialing and 2.4G Wi-Fi)

DS-MP7508/GLF/WI58, (Supports 4G dialing and 5.8G Wi-Fi)



Specifications

Model		DS-MP7508
Video/Audio Input	Analog Camera	8 TVI cameras, up to 1080p resolution
	Two-way Audio	1, integrated in EXT.DEV interface
Video/Audio Output	Video Output	1 CVBS video output, 1 VGA video output
Encoding/Decoding Parameters	Video Compression	H.264, H.264+
	Encoding Resolution	Main stream: 1080/720/WD1/4CIF, sub-Stream: 4CIF/2CIF/CIF
	Frame Rate	PAL: 1 to 25fps, NTSC: 1 to 30fps;
	Audio Compression	G.711
	Stream Type	Video, video & audio
	Audio Bitrate	16 Kbps
	Dual Stream	Supported
Storage	HDD/SSD	2 × 2.5 inch HDD/SSD, up to 2 TB for each HDD/SSD
Wireless Network	3G/4G Dialing	1 × 3G/4G card slot, 1 × Rosenberger antenna
	SD card	1 × SD card slot, up to 256 GB
	Wi-Fi	<ul style="list-style-type: none"> ● WI58 model: 2 × 5.8 G Wi-Fi SMA antenna ● WI model: 1 × 2.4 G Wi-Fi SMA antenna
Positioning	GNSS (Global Navigation Satellite System)	GPS (Global Positioning System), 1 × Rosenberger antenna
External Interface	Network Interface	1 × RJ45 10M/100M/1000M self-adaptive Ethernet interface
	Serial Port	1 × RS-232, 1 × RS-422
	USB Interface	<ul style="list-style-type: none"> ● Front panel: 1 × standard USB 2.0 and 1 × A-type USB 3.0 ● Rear panel: 1 × USB 2.0 of 5-pin aviation plug
	Sensor-in	4 high/low level signal inputs, 1 pulse signal inputs
	Alarm Input	4 high/low level signal inputs
	Alarm Output	2 relay signal outputs
General	Operating Method	Mouse, IR remote control, and Web control
	Power Supply	9 to 32 VDC
	Consumption	<ul style="list-style-type: none"> ● Standby: ≤ 0.5 W ● Full load: ≤ 99 W Note: Without peripheral and storage media: ≤ 20 W
		Working Temperature
	Working Humidity	10% to 90%
	Dimensions (W × D × H)	202 × 260.6 × 85.5mm (8.0 × 10.3 × 3.4 inch)
	Weight (Without Storage Media)	3 kg (6.6 lb)

Physical Interfaces

Front Panel

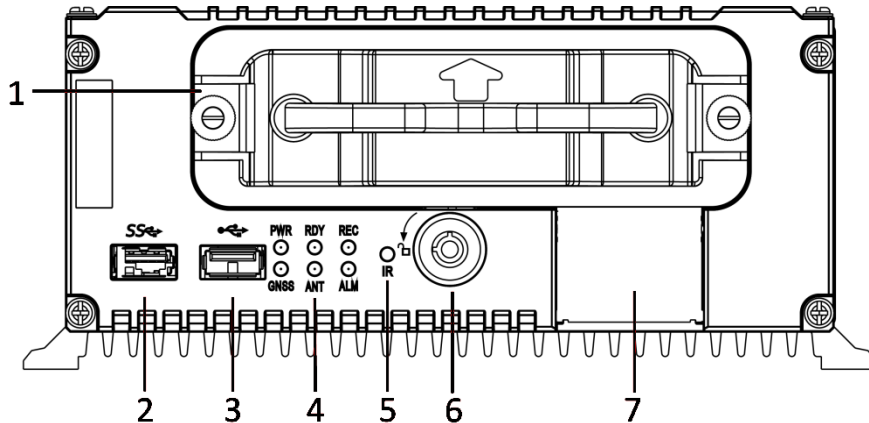





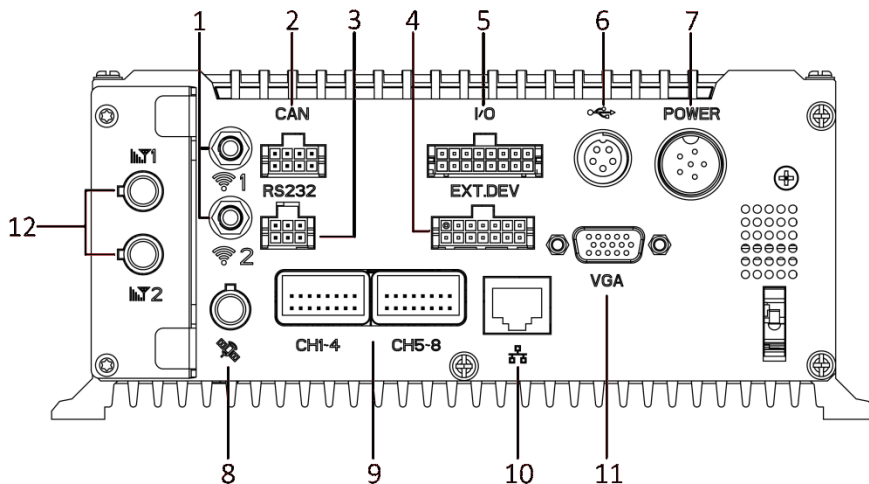

No.	Name	No.	Name
1	Dummy HDD	4	Power indicator
2	A-type USB 3.0 interface		Ready indicator
3	Standard USB 2.0 interface		Record indicator
5	IR receiver		GNSS indicator
6	Lock/Unlock the hard disk box.		ANT indicator
7	SD card slot		Alarm indicator

Rear Panel

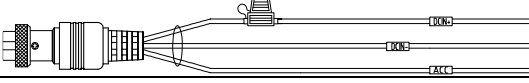
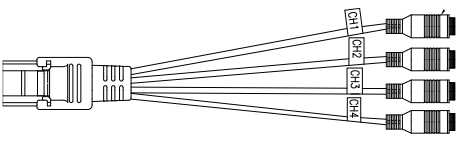
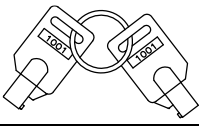
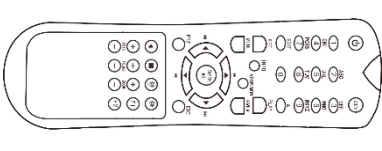

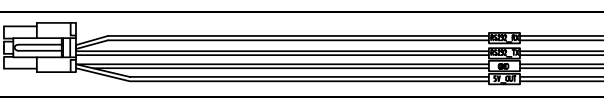
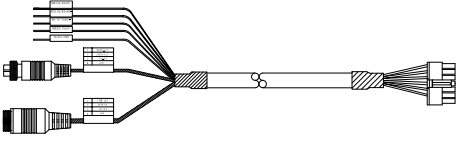
No.	Name	No.	Name
1	Wi-Fi antenna interface	7	6-pin aviation plug for power supply
2	CAN interface	8	GNSS antenna interface
3	RS-232 interface	9	Video inputs
4	RS-422 communication interface, two-way audio interface, and CVBS video output.	10	Network interface
5	4-ch alarm inputs, 4-ch sensor in; 1-ch pulse signal input.	11	VGA video output interface
6	USB interface of 5-pin aviation plug	12	3G/4G dialing antenna interface

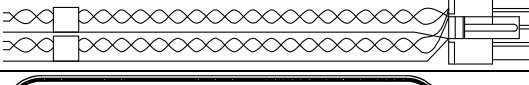
Packing List

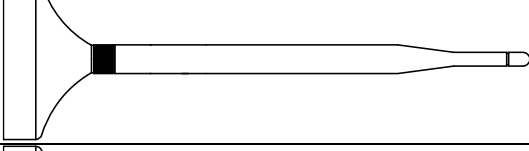
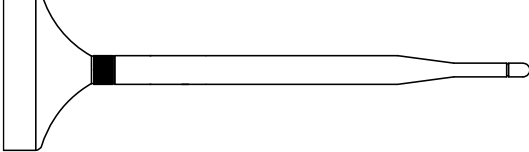
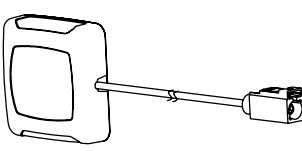
Description	Quantity	Picture	Note
Fuse	2		
Power cord	1		
Video cable	2		
Key	1		
Remote control	1		
Alarm line	1		
Serial port line	1		
Extension cable	1		
Screwdriver	1		
CAN cable	1		
3G/4G antenna	1		For GW and GLF model.
Wi-Fi antenna (2.4G)	1		For WI model.
Wi-Fi antenna (5.8G)	2		For WI58 model.
GPS antenna	1		For model with GPS module.

Peripheral Connection

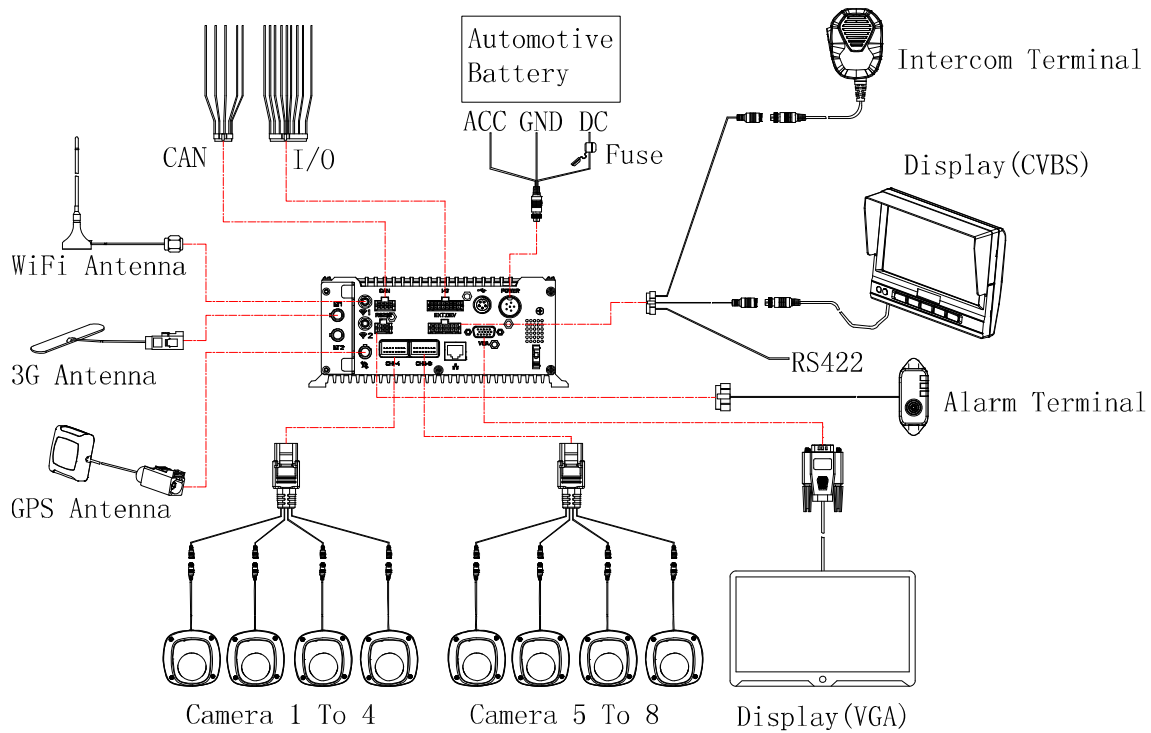

Distributed by



HIKVISION

Headquarters

No.555 Qianmo Road, Binjiang District,
Hangzhou 310051, China
T +86-571-8807-5998
overseasbusiness@hikvision.com

Hikvision USA
T +1-909-895-0400
sales.usa@hikvision.com

Hikvision Australia
T +61-2-8599-4233
salesau@hikvision.com

Hikvision India
T +91-22-28469900
sales@pramahikvision.com

Hikvision Canada
T +1-866-200-6690
sales.canada@hikvision.com

Hikvision Thailand
T +662-275-9949
sales.thailand@hikvision.com

Hikvision Europe
T +31-23-5542770
sales.eu@hikvision.com

Hikvision Italy
T +39-0438-6902
info.it@hikvision.com

Hikvision Brazil
T +55 11 3318-0050
Latam.support@hikvision.com

Hikvision Turkey
T +90 (216)521 7070- 7074
sales.tr@hikvision.com

Hikvision Malaysia
T +601-7652-2413
sales.my@hikvision.com

Hikvision UK & Ireland
T +01628-902140
sales.uk@hikvision.com

Hikvision South Africa
Tel: +27 (10) 0351172
sale.africa@hikvision.com

Hikvision France
T +33(0)1-85-330-450
info.fr@hikvision.com

Hikvision Kazakhstan
T +7-727-9730667
nikia.panfilov@hikvision.ru

Hikvision Vietnam
T +84-974270888
sales.vt@hikvision.com

Hikvision UAE
T +971-4-4432090
salesme@hikvision.com

Hikvision Singapore
T +65-6684-4718
sg@hikvision.com

Hikvision Spain
T +34-91-737-16-55
info.es@hikvision.com

Hikvision Tashkent
T +99-87-1238-9438
uzb@hikvision.ru

Hikvision Hong Kong
T +852-2151-1761
info.hk@hikvision.com

Hikvision Russia
T +7-495-669-67-99
saleru@hikvision.com

Hikvision Korea
T +82-(0)31-731-8817
sales.korea@hikvision.com

Hikvision Poland
T +48-22-460-01-50
info.pl@hikvision.com

Hikvision Indonesia
T +62-21-2933759
Sales.Indonesia@hikvision.com

Hikvision Colombia
sales.colombia@hikvision.com