

### Key Features:

- ▶ High power and long excursion driver for lower frequency reproduction.
- ▶ High sensitivity with lower power compression
- ▶ Large port for high output and low-frequency reinforcement
- ▶ Multiple Attachment Points for Ultimate Flexibility
- ▶ Robust 18 mm multiply hardwood with textured black finish

### Applications:

- ▶ Performing Spaces
- ▶ Clubs & Bars
- ▶ Houses of Worship
- ▶ Multi Media Spaces
- ▶ Retail & Hospitality Spaces
- ▶ Presentation Suites
- ▶ Educational Facilities

AC115S is a high power subwoofer system comprised of one 385 mm (15 in) low frequency driver in a vented, front-loaded configuration for extended bandwidth. The rectangular cabinet is fitted with M10 threaded suspension points for ultimate flexibility.

As a part of JBL's AE Application Engineered Series, a versatile family of loudspeakers for a wide variety of fixed installation applications, AC115S provides a natural low-frequency sound quality.



### Specifications:

<b>System:</b>	
Frequency Range (-10 dB) <sup>1</sup> :	32 Hz - 250 Hz
Frequency Response (±3 dB) <sup>1</sup> :	40 Hz - 250 Hz
System Sensitivity (1w @ 1m) <sup>1</sup> :	94 dB
Nominal Impedance:	8 ohms
Maximum SPL(1m) <sup>2</sup> :	120 dB (126 dB peak)
Long-Term System Power Rating (IEC) <sup>3</sup> :	400 W/800 W/1600 W (Continuous/Program/Peak)
2 hr Power Rating <sup>4</sup> :	500W (2000W peak), 2 hrs
<b>Transducers:</b>	
Low frequency driver:	1 x 15" woofer (P/N: 5055679), 385 mm (15 in) driver with 75 mm (3 in) voice-coil
<b>Physical:</b>	
Input Connector:	Dual Neutrik NL4MP connectors plus covered barrier trip terminals
Enclosure:	18 mm multi-ply hardwood plywood
Grille:	Powder coated, 1.5mm perforated steel, with acoustically transparent black foam backing
Finish:	Textured black paint finish. White (-WH) available upon request. Not available with WRC & WRX finish.
Suspension / Mounting:	12 x M10 threaded suspension points
Dimensions (H x W x D):	483 mm x 419 mm x 600 mm 19 in x 16.5 in x 23.6 in
Net Weight:	24 kg (52.9 lbs)

<sup>1</sup> Full space (4π) conditions

<sup>2</sup> Calculated maximum SPL based on rated power handling

<sup>3</sup> Pink noise, 35~350Hz, 6dB crest factor, 18dB per oct cutoff, 100hrs

<sup>4</sup> AES standard, one decade pink noise with 6 dB crest factor within device's operational band, free air. Standard AES 2 hr rating plus long-term 100 hr rating are specified for low-frequency transducers.

JBL continually engages in research related to product improvement. Some materials, production methods and design refinements are introduced into existing products without notice as a routine expression of that philosophy. For this reason, any current JBL product may differ in some respect from its published description, but will always equal or exceed the original design specifications unless otherwise stated.

# ▶ AC115S 15" High Power Subwoofer System

## Frequency Response, 1W/1m:

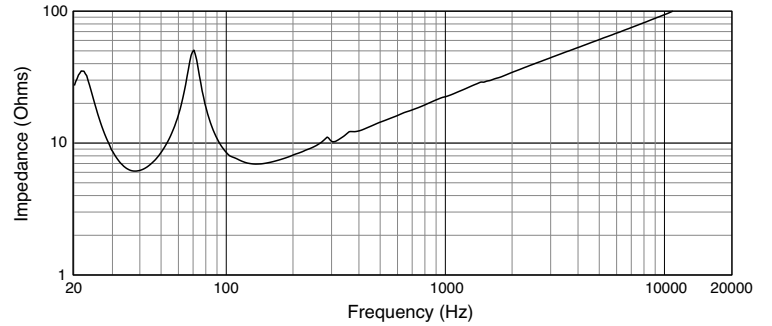
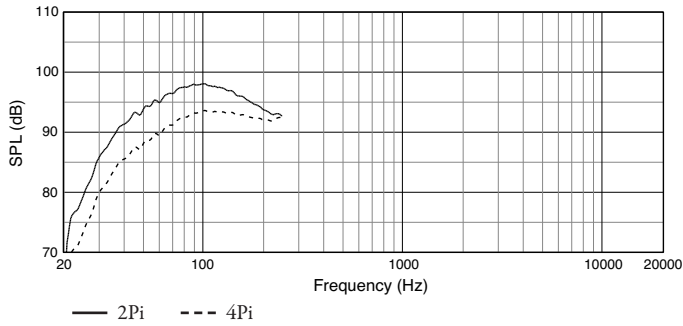

## Dimensions:

Dimensions in mm (inch)

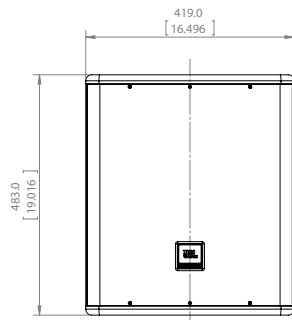
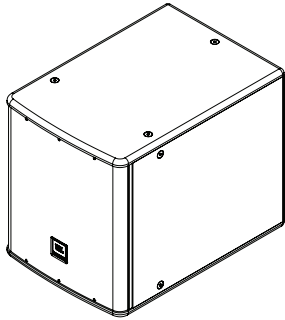

FRONT

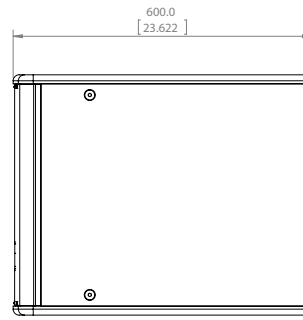

SIDES

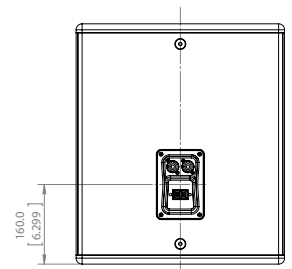

REAR

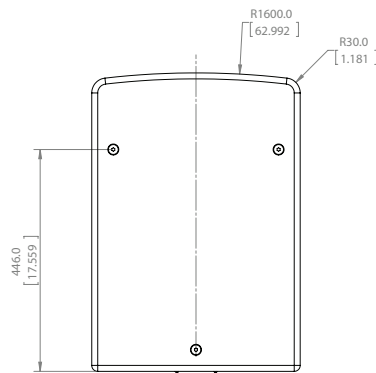
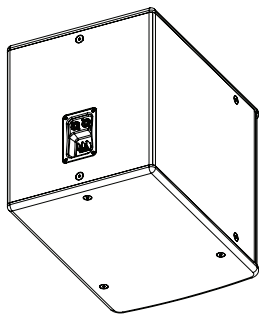

TOP



JBL Professional  
8500 Balboa Boulevard, P.O. Box 2200  
Northridge, California 91329 U.S.A.

© Copyright 2015 JBL Professional  
www.jblpro.com

AC115S  
SZ  
07/15