

LED

FULL HD 1080p

18.5 INCH HD SDI IN / OUT



<b>1080P</b> Full HD	<b>LED</b> LED Backlight	<b>PIP / PBP</b>	<b>16.7</b> Million Color Display Color	<b>Metal Chasis</b>
-------------------------	-----------------------------	------------------	---	---------------------

SD · HD · 3G-SDI

# 19HSDI3G

## OVERVIEW

The ORION Images 19HSDI3G incorporates the SD / HD / 3G-SDI formats with latest panel and image processing technology to provide higher contrast and accurate scaler at a price that fits your budget.

## FEATURES

- Full HDTV display that delivers real time broadcast grade images
- LED backlight to extend the lifetime and save power
- SD / HD / 3G-SDI (level A) is supported in addition to composite, PC (VGA), Component, DVI-D and HDMI inputs
- Non-glare surface coating
- Wireless remote control
- PIP / PBP multi display function



**24/7/365**  
Built to run 24 x 7 x 365  
Continuously

### SPECIFICATIONS

19HSDI3G	
<b>Display</b>	
Screen Size	18.5 Inch
Max. Resolution	1366 x 768 @ 60Hz
Pixel Pitch	0.300 x 0.300mm
Surface	Non-glare coating
Brightness	250cd/m <sup>2</sup>
Contrast Ratio	1000 : 1
Aspect Ratio	16 : 9
Viewing Angle (H/V)	170° / 170°
Display Color	16.7 Million
Response Time	< 5ms (Gray to Gray)
Video System	NTSC / PAL
<b>Interface</b>	
SDI In / Out	1 In / 1 Out
SD-SDI	480i (59.94) / 575i (50)
HD-SDI	720P (50 / 59.94 / 60) 1080i (50 / 59.94 / 60) 1080P (24 / 25 / 29.97 / 30)
3G-SDI	1080P (50 / 59.94 / 60)
Video In / Out (BNC Type)	2 In / 2 Out
S-Video In / Out	1 In
DVI-D In / HDMI In	1 In / 2 In
VGA In (15Pin D-Sub)	1 In
Audio In (RCA Type)	2 Left & Right
PC Stereo In	1 In
<b>Transmitter</b>	
Remote Control	Yes
<b>Audio</b>	
Built-in Speakers	Yes (1W x 2)
<b>Features</b>	
Multi Display Function	PIP / PBP
Filter Type	3D Comb Filter is built-in
Deinterlacing	Yes
Noise Reduction	Yes
Advanced Auto Power Recovery	Yes
Trigger Sensor	Yes
Auto Pixel Shift	Yes
Auto Source Sequencing	Yes
Multi Language	English, Spanish, French, German, Italian
<b>General (W x H x D)</b>	
Outline Dimension	17.64" x 11.72" x 3.58"
Net Weight	4.8Kg (10.58 lbs)
Material / Color	Metal / Black
Desk Top Stand	Kick Type
Power	< 27W DC12V / 3.33A
Operating Temperature	AC100 ~ 240V (50/60Hz) 0 ~ 40° C / 32 ~ 104° F
<b>Optional Mounts</b>	
VESA™ Mount Size	100 x 100mm
Wall	WB-5, WB-10, WB-30, WB-31
Ceiling	CMK-01

\*Design and specifications are subject to change without notice

### INPUT INTERFACE

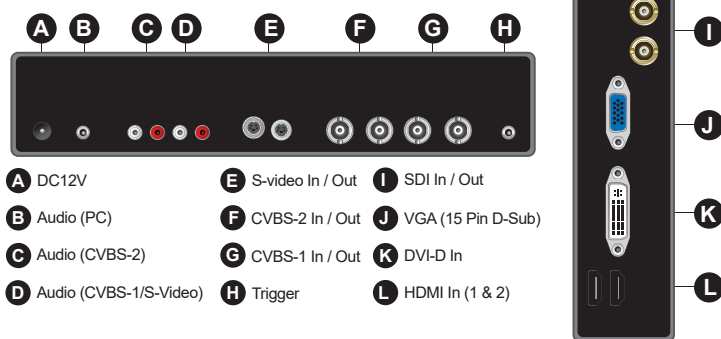

### DIMENSIONS

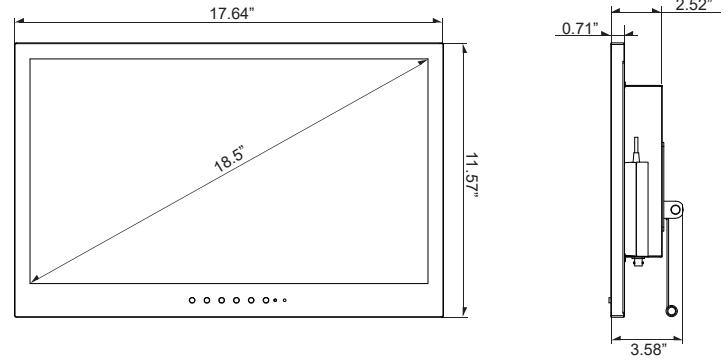

### REAR VIEW AC ADAPTER



### AVAILABLE ACCESSORY



**HD CCTV Cameras**

- Full HD (1920 x 1080 30p) Video
- High resolution video with Progressive Scan
- HD Serial Digital Interface Type Video Output
- Minimum illumination 1Lux-Auto Switching Mode at 12 Lux



**4CH Digital Splitter (CDS4S)**

- Auto System Recovery
- Digital video splitter only for High definition camera (HD-SDI/HDMI)
- Various video output mode (1920x1080, 1280x1024, 1280x960, 1280x720, 1024x768)
- Support RS-232, RS-485



**HD Receiver (CSDHRC)**

- HDMI device which is receiving HD-SDI video of 2.2M pixel camera
- This box type HD-SDI receiver can connect to monitor directly. (BNC In & DVI Out)





**HD Repeater / Distributer (2CH) (CSDRP2)**

- Distance extension device for HD-SDI. In addition, there are two outputs from one input. Therefore, user can use two monitors with one HD-CCTV camera. When user uses repeater between HD-CCTV and Receiver, the distance can be increased 300ft per repeater.

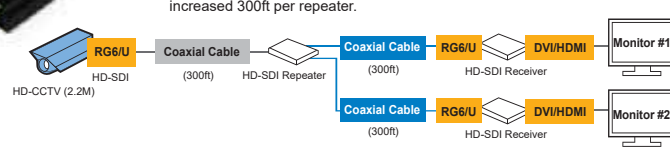



**HD Repeater / Distributer (8CH) (CSDRP8)**

- Distance extension device for HD-SDI. In addition, there eight outputs from one input

