

Technical Manual

JBL AM7212/66-WH



SPECIFICATIONS

ACOUSTIC & ELECTRICAL SPECIFICATIONS:

- Nominal Impedance: 8 Ohms
- Transducer Power Rating (AES): LF: 1000W (4000W peak), 2 hrs
700W (2800W peak), 100 hrs
HF: 100W (400W peak), 2 hrs
- Long-Term Power Rating (IEC): Passive mode: 600W (2400W peak), 100 hrs
- Frequency Response: 42 Hz - 20 kHz (± 3 dB)
- Frequency Range: 36 Hz - 20 kHz (-10 dB)
- Maximum SPL: Bi-amp mode: LF: 126 dB-SPL cont avg (132 dB peak)
HF: 134 dB-SPL cont avg (140 dB peak)
Passive mode: 123 dB-SPL cont avg (129 dB peak)
- System Sensitivity: Passive mode: 95 dB SPL
1 watt @ 1 meter
- Passive Crossover Frequency: 1.6 kHz

SYSTEM COMPONENTS:

- Cabinet: Enclosure (Not For Sale)
- Grille: 338163-007, 338163-107 (WH)
- Low Frequency: 2262HPL, 300 mm (12 in)

SYSTEM COMPONENTS: (CONT'D)

- Transducer: Differential Drive®, driver with 75 mm (3 in) dual voice coil
5.1 ohm
- DC Resistance: 2432H, 38 mm (1.5 in) exit compression driver, 75 mm (3 in) voice coil
- High Frequency Transducer: 4.00 ohm +/- 0.2 ohm
- DC Resistance: 443837-001
- Crossover Network: 443837-001

AURAL SWEEP TEST SPECIFICATIONS:

- A. System Aural Sweep Test: 7.0V Input, 20 Hz to 20 kHz
Sweep Duration: 5 seconds
- B. L.F. Aural Sweep Test: 10V Input, 10 Hz to 1 kHz
- C. H.F. Aural Sweep Test: 3.0V Input, 300 Hz to 1.0 kHz

PHYSICAL SPECIFICATIONS:

- Enclosure Dimensions: 711 x 369 x 458 mm D
(28.0 x 14.5 x 18.0 in.D.)
- Net Weight: 51 lb (23.1 kg.)

WARRANTY INFORMATION:

- Refer to Warranty Statement packed with each product.

PACKAGE

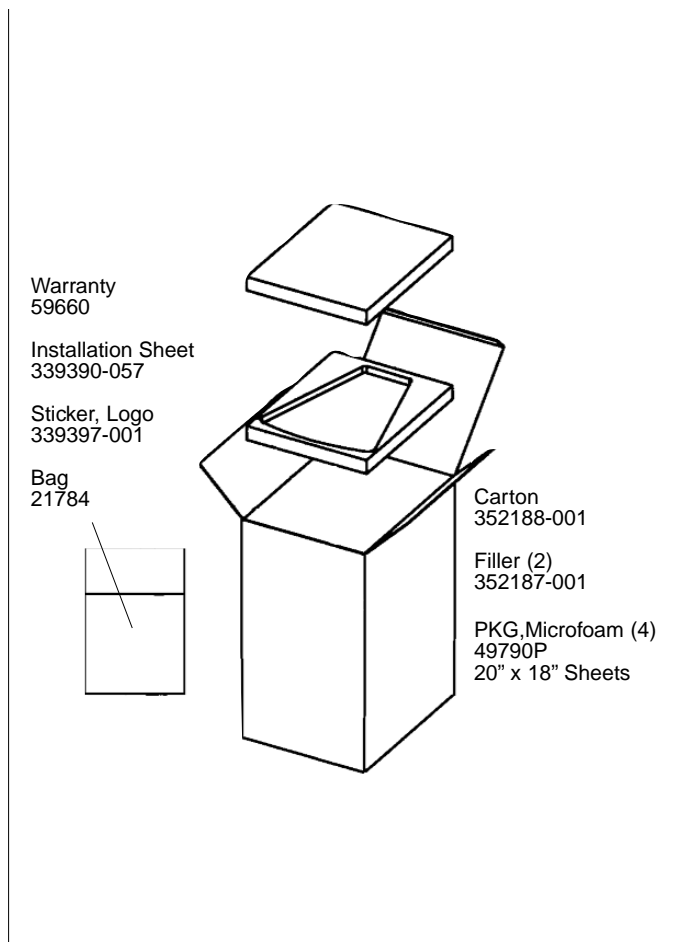

WIRING DIAGRAM

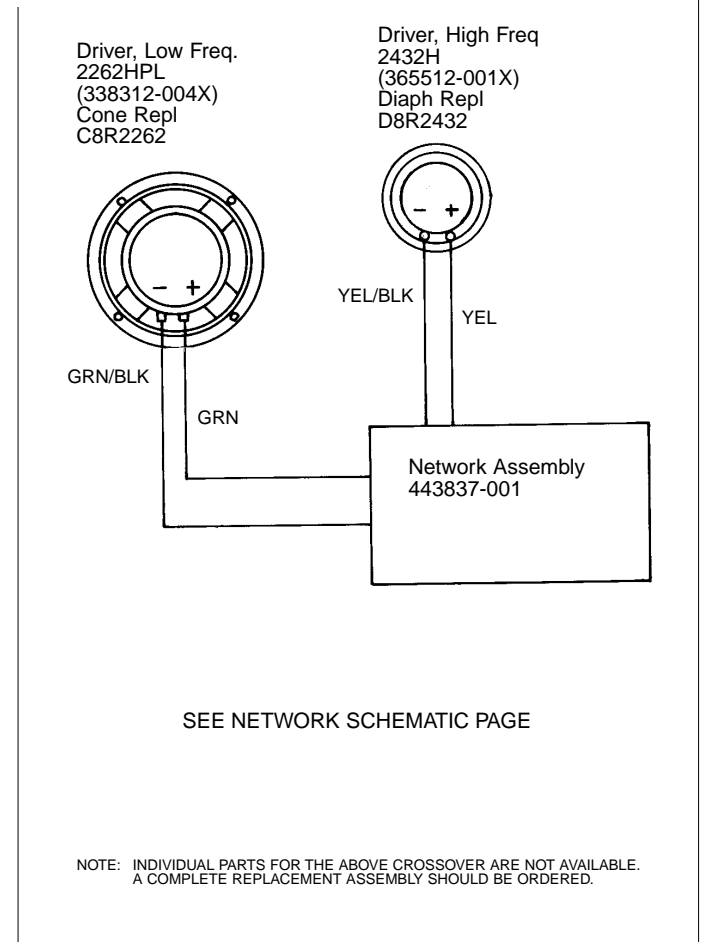

JBL AM7212/66-WH REV B

JBL AM7212/66-WH

SCHEMATIC (443837-001)

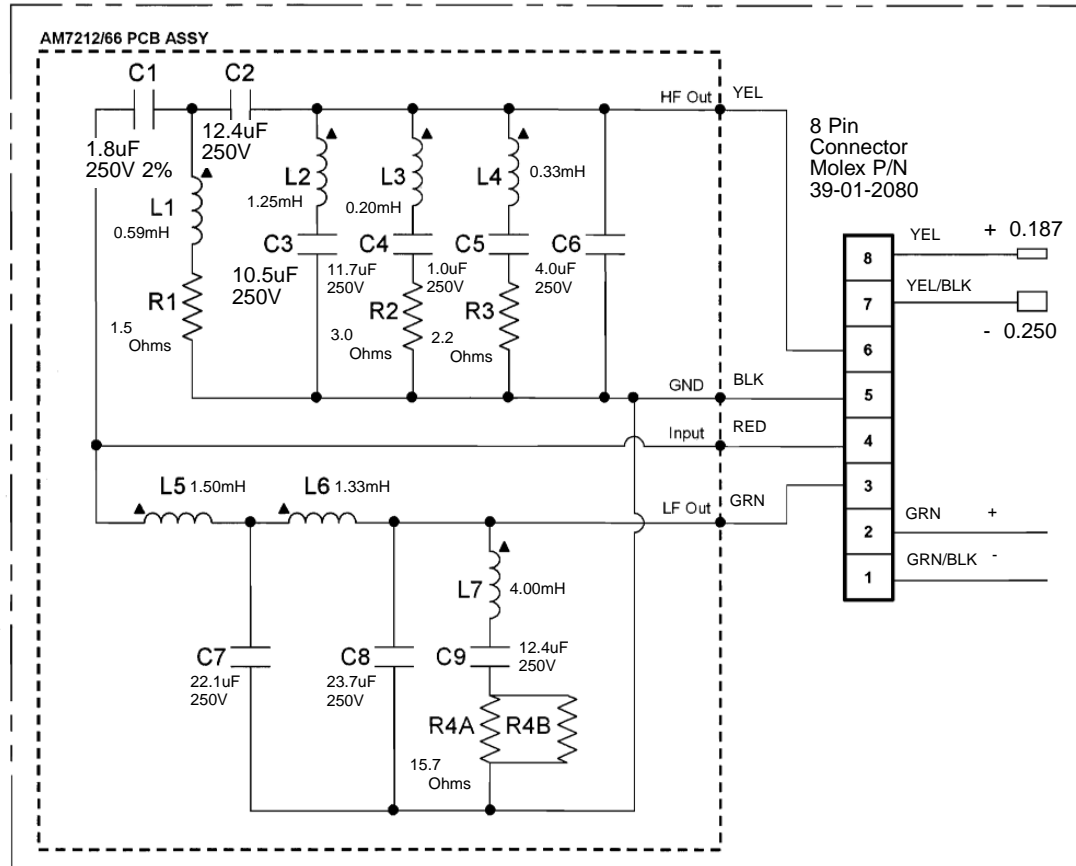

VIEW FROM CONNECTOR PIN SIDE

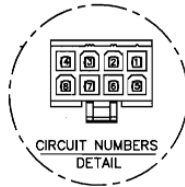

Individual Parts for the above crossover are not available.
A complete replacement assembly should be ordered.

JBL AM7212/66-WH

JBL AM7212/66-WH

COMPONENT EXPLODED VIEW

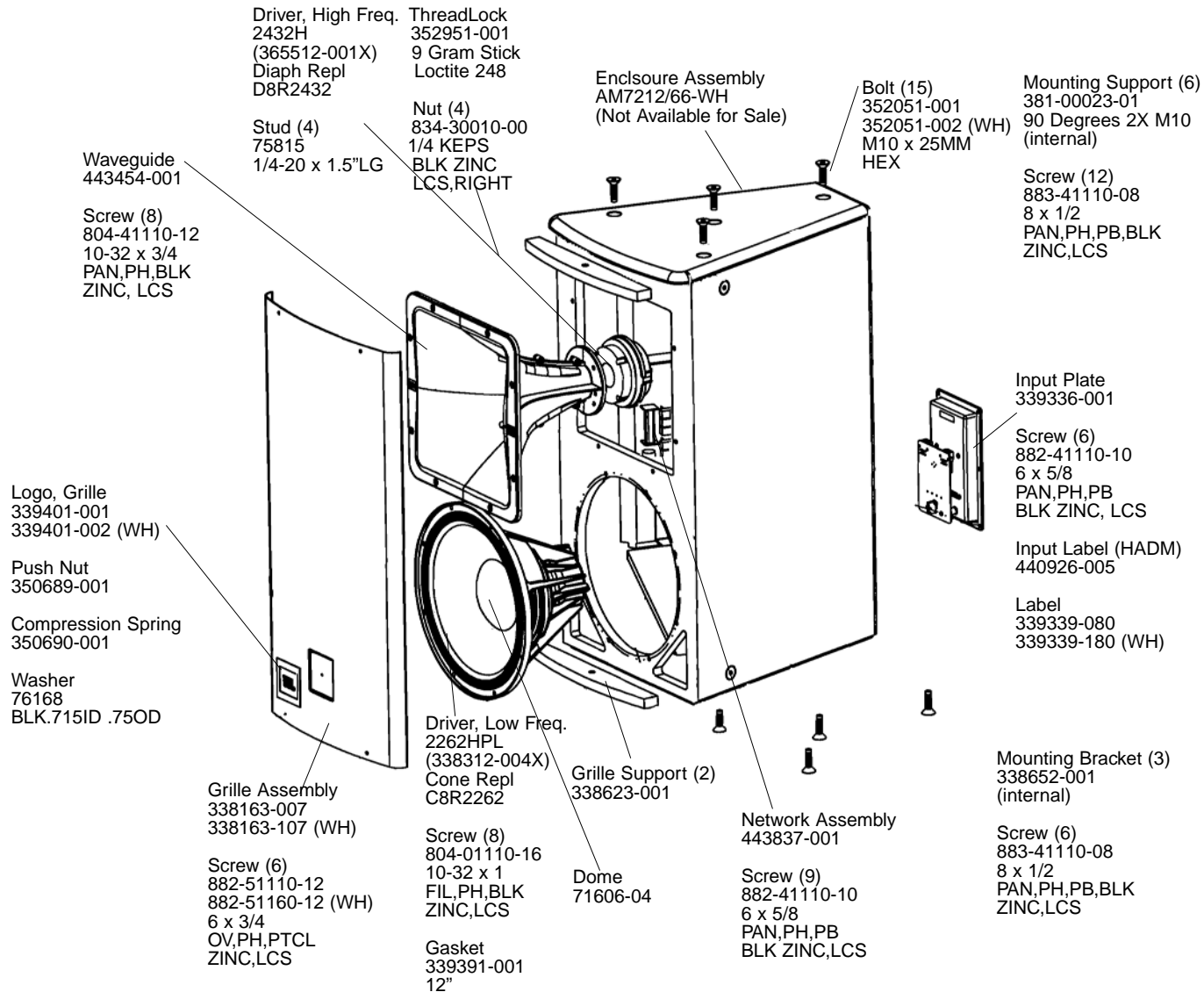

JBL AM7212/66-WH