

## Planar Simplicity Series 4K Displays



**SL4364K**  
**SL5064K**  
**SL5564K**  
**SL6564K**  
**SL7564K**  
**SL8664K**

Copyright © August 2018 by Leyard Optoelectronics Co., Ltd. and Planar Systems, Inc.  
All rights reserved.

This document may not be copied in any form without permission from Leyard or Planar. Information in this document is subject to change without notice.

#### Trademark Credits

Windows™ is a trademark of Microsoft Corp.

All other companies are trademarks or registered trademarks of their respective companies.

#### Disclaimer

The information contained in this document is subject to change without notice. Leyard and Planar Systems, Inc. makes no warranty of any kind with regard to this material. While every precaution has been taken in the preparation of this manual, the Company shall not be liable for errors or omissions contained herein or for incidental or consequential damages in connection with the furnishing, performance, or use of this material.

#### Warranty and Service Plans

Planar warranty and service plans will help you maximize your investment by providing great support, display uptime, and performance optimization. From post-sale technical support, to a full suite of depot services, our services are performed by trained employees. When you purchase a Planar product, you get more than a display; you get the service and support you need to maximize your investment. To find the latest warranty and service information regarding your Planar product, please visit <http://www.planar.com/support> or <http://www.leyard.com/en/support/>

Part Number: 020-1343-00D

# Table of Contents

<b>Introduction</b>	7
1. Safety Information	8
2. Safety Precautions	8
2.1 Important Safety Instructions	9
3. Recommended Usage	10
3.1 Burn-In Versus Temporary Image Retention	10
3.2 Warranty Coverage	10
3.3 Important Waste Disposal Information	11
3.4 Normal Usage Guidelines	11
4. VESA Mounts, General Description	12
5. Cleaning the Display	13
<b>Package Contents</b>	14
6. Installing the Cable Clips	16
7. Planar Simplicity Series- Standard Inputs	17
<b>Installing the Display</b>	18
8. Before You Begin	18
8.1 Tools/Equipment List	18
8.2 Other Things You May Need	18
8.3 Plan Your Installation	18
8.4 Prepare Your Installation Location	19
9. Installing OPS Expansion (Optional)	20
<b>Operating the Display</b>	21
10. OSD Keypad	21
11. Remote Control Receiver	22
12. LED Indicators	23
13. Using the Display in Flat or Tilted Orientation	24
14. Using the Remote Control	25
15. Pairing the Remote Control to the Display	26
16. Basic Remote Functions	27
16.1 Turning the Display On	27
16.2 Turning the Display Off	27
16.3 Adjusting the Volume	27
16.4 Selecting the Input Source	27

16.5	Navigating Through the Menus.....	27
17.	OSD Initial Settings Menu.....	28
17.1	Initial Configuration / Importing Settings .....	28
18.	Input Menu.....	33
18.1	Source Options .....	33
19.	OSD Main Menu .....	34
19.1	Picture.....	34
19.2	Screen.....	37
19.3	Audio.....	40
19.4	Configuration 1 .....	42
19.5	Configuration 2.....	44
19.6	Advanced Settings .....	46
20.	OSD Android Settings Menu.....	50
20.1	Android Main Menu .....	50
20.2	Settings.....	50
20.3	Apps.....	60
20.4	Network.....	61
20.5	Storage .....	61
21.	Media Player.....	62
21.1	Supported Media Formats .....	62
21.2	Main Menu .....	64
22.	Browser Menu .....	69
22.1	Settings.....	69
22.2	Boot on Source Functionality.....	73
23.	Content Management System.....	74
23.1	Initial Setup .....	74
23.2	Login .....	74
23.3	Main Menu .....	75
	<b>External Control.....</b>	<b>82</b>
	<b>Signal Compatibility .....</b>	<b>83</b>
	<b>Color Subsampling Support .....</b>	<b>84</b>
	<b>Specifications .....</b>	<b>85</b>
	<b>Dimensions.....</b>	<b>87</b>
	SL4364K.....	87
	SL5064K.....	88
	SL5564K.....	89

SL6564K.....	90
SL7564K.....	91
SL8664K.....	92
<b>Troubleshooting</b> .....	<b>93</b>
<b>Accessing the Planar Technical Support Website</b> .....	<b>94</b>
<b>Index</b> .....	<b>95</b>



# Introduction

The Planar® Simplicity™ Series 4K line of displays for digital signage incorporates cutting-edge 4K at 60Hz streaming, media playback, a sleek design and commercial functionality into an affordable 4K digital signage solution.

Ranging in size from 43" to 86", Planar Simplicity Series 4K displays eliminate the need for additional hardware, reducing installation cost and complexity.

Featuring an elegant design with logo-free narrow bezel and slim profile, the Planar Simplicity Series 4K is the ideal display solution for digital signage applications in retail stores, restaurants, medical offices, corporate meeting areas and hospitality.

Designed for commercial installations, Planar Simplicity Series 4K comes standard with a full array of connectivity and external control, including support for native 4K resolution at up to 60Hz via HDMI 2.0, enabling smooth motion video and mouse tracking. Compatible with new and emerging 4K sources, the Planar Simplicity Series 4K uses HDCP 2.2-compliant HDMI 2.0 inputs.

**Caution:** This manual is intended for use by qualified service persons and end users with experience installing LCD displays.

# 1. Safety Information

Before using the Planar Simplicity Series 4K, please read this manual thoroughly to help protect against damage to property, and to ensure personnel safety.

- Be sure to observe the following instructions.
- For your safety, be sure to observe ALL the warnings detailed in this manual.
- For installation or adjustment, please follow this manual's instructions, and refer all servicing to qualified service personnel.

# 2. Safety Precautions

- **If water is spilled or objects are dropped inside the display, remove the power plug from the outlet immediately.** Failure to do so may result in fire or electrical shock. Contact your dealer for inspection.
- **If the display is dropped or the chassis is damaged, remove the power plug from the outlet immediately.** Failure to do so may result in fire or electrical shock. Contact your dealer for inspection.

**WARNING!** Wall mounts must be secure.

- **If the display is hung on a wall, the wall must be strong enough to hold it.** Simply mounting it to wallboard or wall paneling won't be adequate or safe.

**Caution:** The screen could be damaged by heavy pressure.

- **Slight pressure on the LCD will cause distortion of the image.** Heavier pressure will cause permanent damage. Displays should be mounted where viewers cannot touch the screen or insert small objects in the openings that will create hazards by contacting bare conductive parts.

**Caution:** The front polarizer is soft and subject to scratches from sharp objects.

- **The polarizer is a thin sheet of film laminated to the outside layer of glass on the LCD screen.** Take care when handling items near the screen.
- **If the power cord or plug is damaged or becomes hot, turn off the main power switch of the display. Make sure the power plug has cooled down and remove the power plug from the outlet.** If the display is still used in this condition, it may cause a fire or an electrical shock. Contact your dealer for a replacement.



## 2.1 Important Safety Instructions:

1. Read these instructions.
2. Keep these instructions.
3. Heed all warnings.
4. Follow all instructions.
5. Do not use the display near water.
6. Clean the LCD screens with an LCD screen cleaner or LCD wipes.
7. Do not install near any heat sources such as radiators, heat registers, stoves or other apparatus (including amplifiers) that produce heat.
8. Do not defeat the safety purpose of the polarized or grounding type plug. A polarized plug has two blades with one wider than the other. A grounding type plug has two blades and a third grounding prong. The wide blade or the third prong is provided for your safety. When the provided plug does not fit into your outlet, consult an electrician for the replacement of the obsolete outlet.
9. Protect the power cord from being walked on or pinched, particularly at plugs, convenience receptacles and the point where they exit from any Planar large format LCD display.
10. Only use the attachments/accessories specified by the manufacturer.
11. Unplug all displays during lightning storms or when unused for long periods of time.
12. In instances where a power surge has occurred and a display no longer has an image, the display power will need to be reset.
13. You must follow all National Electrical Code regulations. In addition, be aware of local codes and ordinances when installing your system.
14. Refer all servicing to qualified service personnel. Servicing is required when any of the displays have been damaged in any way, such as the AC power cord or plug is damaged, liquid has been spilled or objects have fallen into a product, the products have been exposed to rain or moisture, do not operate normally or have been dropped.
15. Keep the packing material in case the equipment should ever need to be shipped.
16. Wall mounts must be secure. The wall must be strong enough to hold displays brackets, cables and accessories. Seismic engineers should be consulted in areas prone to earthquakes.
17. Slight pressure on the LCD will cause distortion of the image. Heavier pressure will cause permanent damage. Displays should be mounted where viewers cannot touch the screen or insert small objects in the openings that will create hazards by contacting bare conductive parts.
18. The front polarizer is soft and subject to scratches from sharp objects. The polarizer is a thin sheet of film laminated to the outside layer of glass on the LCD screen. Take care when handling items near the screen.

## 3. Recommended Usage

In order to get the most out of your LCD, use the following recommended guidelines to optimize the display.

### 3.1 Burn-In Versus Temporary Image Retention

Burn-in causes the screen to retain an image essentially forever, with little or no way to correct the problem. Under normal use, an LCD will not experience burn-in, as plasma displays do, nor will it retain images in any way.

Normal use of an LCD is defined as displaying continuously changing video patterns or images. However, LCDs can experience *temporary* image retention when recommended usage guidelines are not followed.

#### ***What is Temporary Image Retention?***

Temporary image retention (TIR) can occur when a static image is displayed continuously for extended periods of time (12 hours or longer). An electrical charge differential may build up between the electrodes of the liquid crystal, which causes a negative-color video image (color-inverted and brightness-inverted version of the previous image) to be retained when a new image is displayed. This behavior is true for any LCD device from any LCD manufacturer.

TIR is not covered under warranty. See standard warranty terms and conditions for details. Here are some guidelines to help you avoid TIR:

- Use the LCD to show a screen saver, moving images or still pictures that change regularly. When using high-contrast images, reposition the images frequently.
- Turn off the LCD when it is not in use. To use your source computer's Power Options Properties, set up your computer to turn off the display when not in use.

### 3.2 Warranty Coverage

The following models are warranted for **16 x 7** usage:

- 43": SL4364K
- 50": SL5064K
- 55": SL5564K
- 65": SL6564K
- 75": SL7564K
- 86": SL8664K

Planar recommends turning off the power for **12 hours per day** for optimal performance.

For complete warranty details, please visit [www.planar.com/warranty](http://www.planar.com/warranty).

### 3.3 Important Waste Disposal Information

Please recycle or dispose of all electronic waste in accordance with local, state, and federal laws. Additional resources can be found online at <http://www.planar.com/about/green/>.

The crossed-out wheelee bin symbol is to notify consumers in areas subject to Waste Electrical and Electronic Equipment (WEEE) Directive 2012/19/EU that the product was placed on the market after August 13, 2005 and must not be disposed of with other waste. Separate collection and recycling of electronic waste at the time of disposal ensures that it is recycled in a manner that minimizes impacts to human health and the environment. For more information about the proper disposal of electronic waste, please contact your local authority, your household waste disposal service, or the seller from whom you purchased the product.



### 3.4 Normal Usage Guidelines

Normal use of the LCD is defined as operating in the open air to prevent heat buildup, and without direct or indirect heat sources such as lighting fixtures, heating ducts, or direct sunlight that can cause the modules to experience high operating temperatures. For all modules, do not block fans or ventilation openings. If the LCD module will be installed in a recessed area with an LCD surround or enclosure, ensure adequate openings are applied for proper air flow and ventilation.

At 3000 meters or below, the maximum ambient operating temperature for the LCD module cannot be above 40° C nor below the minimum ambient operating temperature of 0° C. If one of these conditions exists, it is up to the installer to ensure that module placement is changed, thermal shielding is provided and/or additional ventilation is provided to keep the display within its nominal operating parameters.

#### ***Cooling Requirements***

For optimal performance, active cooling by the installer should be planned for when the ambient temperature at the top of the wall is predicted to be above the specified ambient temperature for the panel. Cooling may be done behind the displays and depending on the wall configuration.

## 4. VESA Mounts, General Description

VESA mounts are used to secure the Planar Simplicity Series 4K display. The display can be installed using a variety of VESA mounts available through Planar. If you do not have a VESA mount, and would like to purchase one, contact Planar.

If you purchased a VESA mount, you should have received a separate box with mounting supplies and an installation manual. Follow these instructions carefully.

Keep in mind the following general installation guidelines:

- Screw length is crucial and will vary depending on the type of mount you use. Total screw length includes the penetration length, plus the length required, by the type of VESA mount in use.

**Caution:** Shorter screws will result in insufficient mounting strength and longer screws could puncture parts inside the display.

- Prior to installation, make sure you know where all of the mounting points are located.
- Follow all safety precautions outlined in the VESA Installation manual.
- Verify the parts received with the list shown in the VESA Installation manual.

## 5. Cleaning the Display





If dust collects on the power plug, remove the plug from the outlet and clean off the dust. Dust build-up may cause a fire.



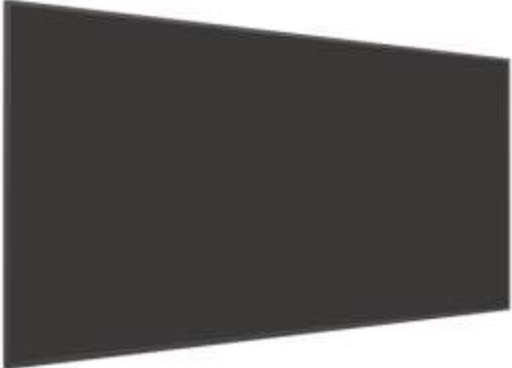

Remove the power plug before cleaning. Failure to do so may result in electrical shock or damage.

Keep the following points in mind when cleaning the surface of the display:

- When the surface of the display becomes dirty, wipe the surface lightly with a soft clean cloth.
- If the surface requires additional cleaning, use LCD screen cleaner or LCD wipes, which are available at most electronics stores.
- Do not let cleaner seep into the display, as it may cause electrical shock or damage.

# Package Contents

Part	Description	Number	Picture
LCD Display	One per box.	1	
HDMI Cable	HDMI cable.	1	
AC Power Cord	Power cord (SL4364K, SL5064K, SL5564K)	1	
AC Power Cord	Power cord (SL6564K, SL7564K, SL8664K)	1	
IR Extender Cable	Receive signals from the remote control.	1	

Part	Description	Number	Picture
Remote Control	Used to control the display (AAA batteries included)	1	
Cable Clips	Used to clamp and organize the cables.	2	
2.5mm to DB9 Adapter	2.5mm to DB9 adapter.	1	
Quick Start Guide	Quick start guide.	1	

## 6. Installing the Cable Clips

Use the cable clips included in the Accessory Kit to assist with cable management. These clips adhere into place using adhesive backing as shown in the image below.

Attach clips near HDMI and AC power cables to assist with cable routing and to release cable strain.

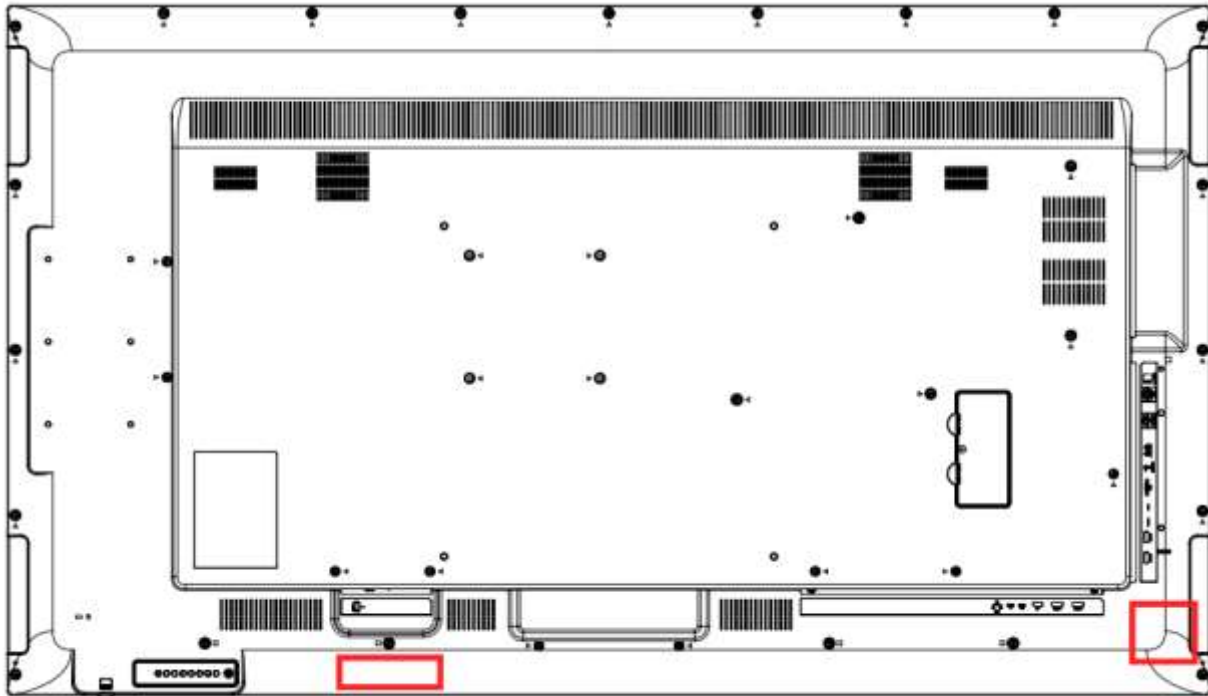



## 7. Planar Simplicity Series- Standard Inputs

### SL4364K/SL5064K/SL5564K

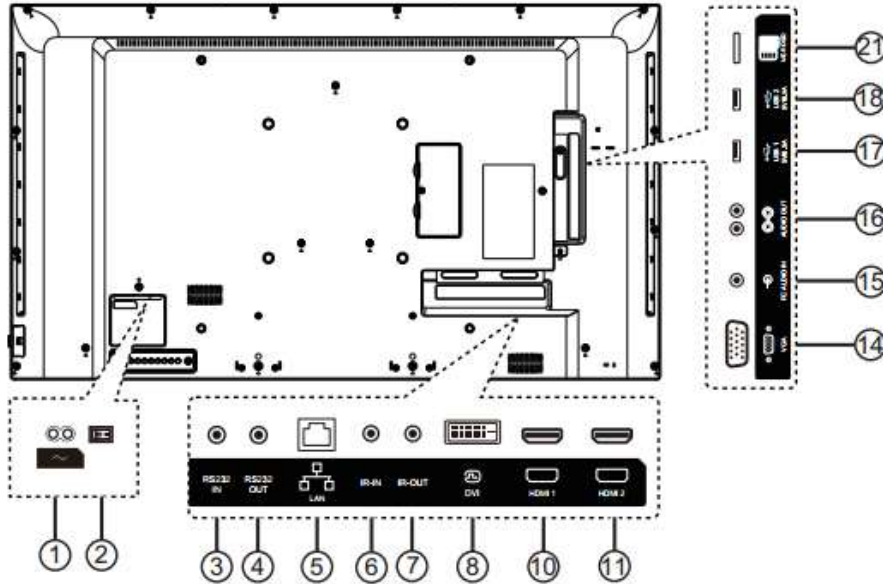

- ① AC IN
- ② MAIN POWER SWITCH
- ③ RS232 IN / ④ RS232 OUT
- ⑤ LAN
- ⑥ IR-IN / ⑦ IR-OUT
- ⑧ DVI
- ⑨ DP
- ⑩ HDMI 1 / ⑪ HDMI 2
- ⑫ HDMI 3 / ⑬ HDMI 4
- ⑭ VGA
- ⑮ PC AUDIO IN
- ⑯ AUDIO OUT
- ⑰ USB 1 / ⑱ USB 2
- ⑲ USB 3 / ⑳ PWR ONLY
- ㉑ MICRO SD

### SL6564K/SL7564K/SL8664K

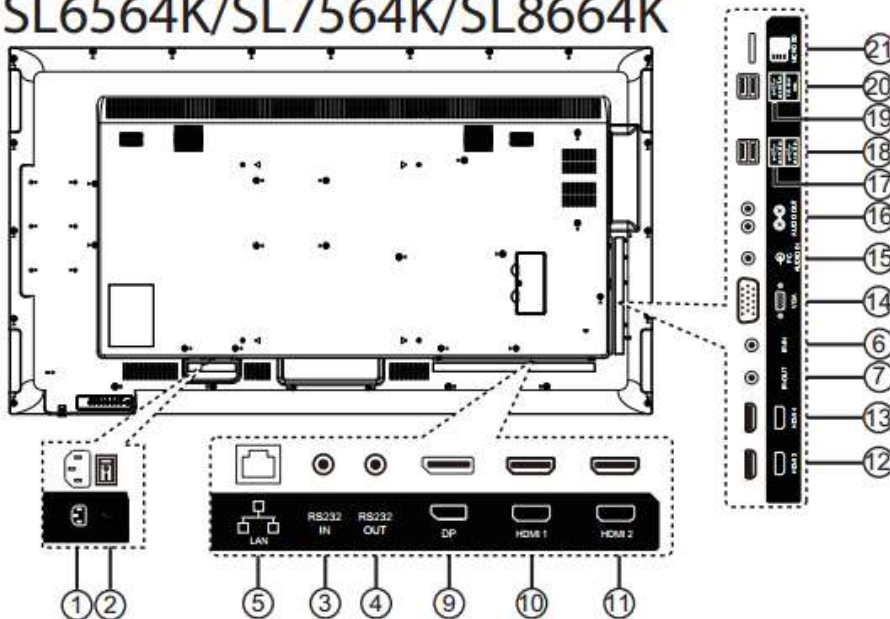

- ①
- ②

- ⑤
- ③
- ④
- ⑨
- ⑩
- ⑪

# Installing the Display

This section explains how to install your display. We suggest that you read the entire section before you attempt to install the unit.

## 8. Before You Begin

Make sure you have all the items in these lists before you begin unpacking and installing your display(s).

### 8.1 Tools/Equipment List

Depending on your installation, you may need one or more of the following items:

- String/string level
- Digital/laser level
- Ladders/lift
- Back brace
- Stud finder (if hanging display on a wall)

### 8.2 Other Things You May Need

- LCD screen cleaner or LCD wipes - available at most electronics stores
- At least two very strong people to help lift unit into place

### 8.3 Plan Your Installation

You should have a detailed plan of how the units are to be configured. The plan should include calculations for the following:

- Power maximums reference below by display size:
  - SL4364K: 8 units max per 20A circuit
  - SL5064K: 8 units max per 20A circuit
  - SL5564K: 8 units max per 20A circuit
  - SL6564K: 5 units max per 20A circuit
  - SL7564K: 4 units max per 20A circuit
  - SL8664K: 3 units max per 20A circuit
- Cable runs
- Ventilation and cooling requirements
- If hanging display on a wall, location of studs in the wall

## 8.4 Prepare Your Installation Location

Prepare the area where you will install the unit. If custom enclosures are part of the installation, they must be fully designed to accommodate the installation of the displays, the installed units, and ventilation and cooling requirements.

If your installation includes a lot of construction or dust, it is **highly recommended** that you clean all of the screens after the wall installation and configuration are complete.

## 8.5 Cable Length Recommendations

Cable length performance may vary between different cables and sources. The recommended maximum cable lengths are as follows:

### HDMI

- 4K @ 50/60Hz: 5m (15 ft) maximum
- 4K @ 24/25/30Hz: 15m (50 ft) maximum
- 1080p @ 60Hz and lower resolutions: 20m (65 ft) maximum

### DisplayPort

- 8m (25 ft) maximum

## 9. Installing OPS Expansion (Optional)

Planar Simplicity Series 4K displays are equipped with an expansion slot that supports the Intel® Open-Pluggable Specification (OPS). The slot supports OPS devices including PCs, SDI modules etc.

To install an OPS device, remove the protective cover on the display and slide the device firmly into position. When installed, the OPS device connects internally to the display. No external video or power cables are required.

**Note:** OPS is only supported on the SL6564K, SL7564K and SL8664K models

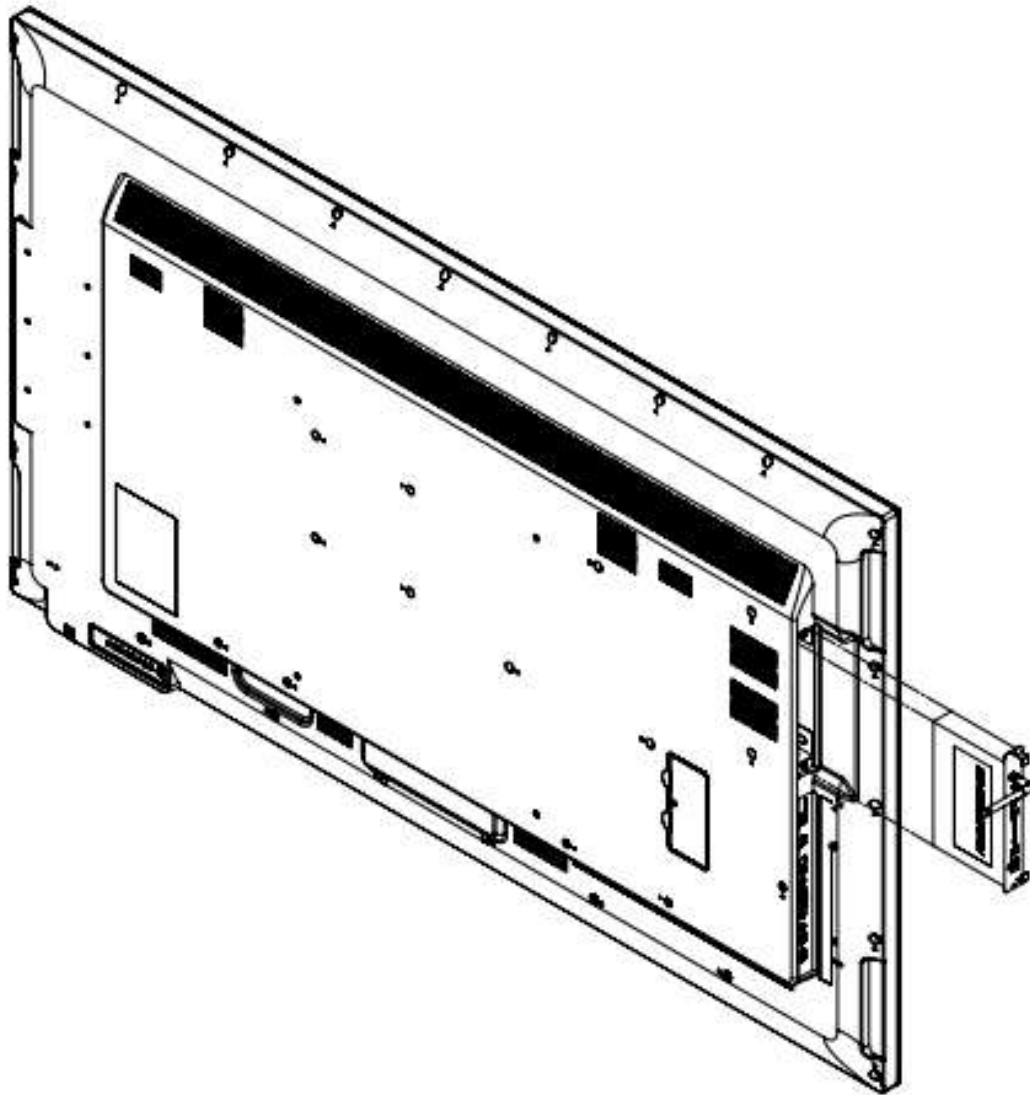

# Operating the Display

## 10. OSD Keypad

The OSD keypad is located on the rear of the display.

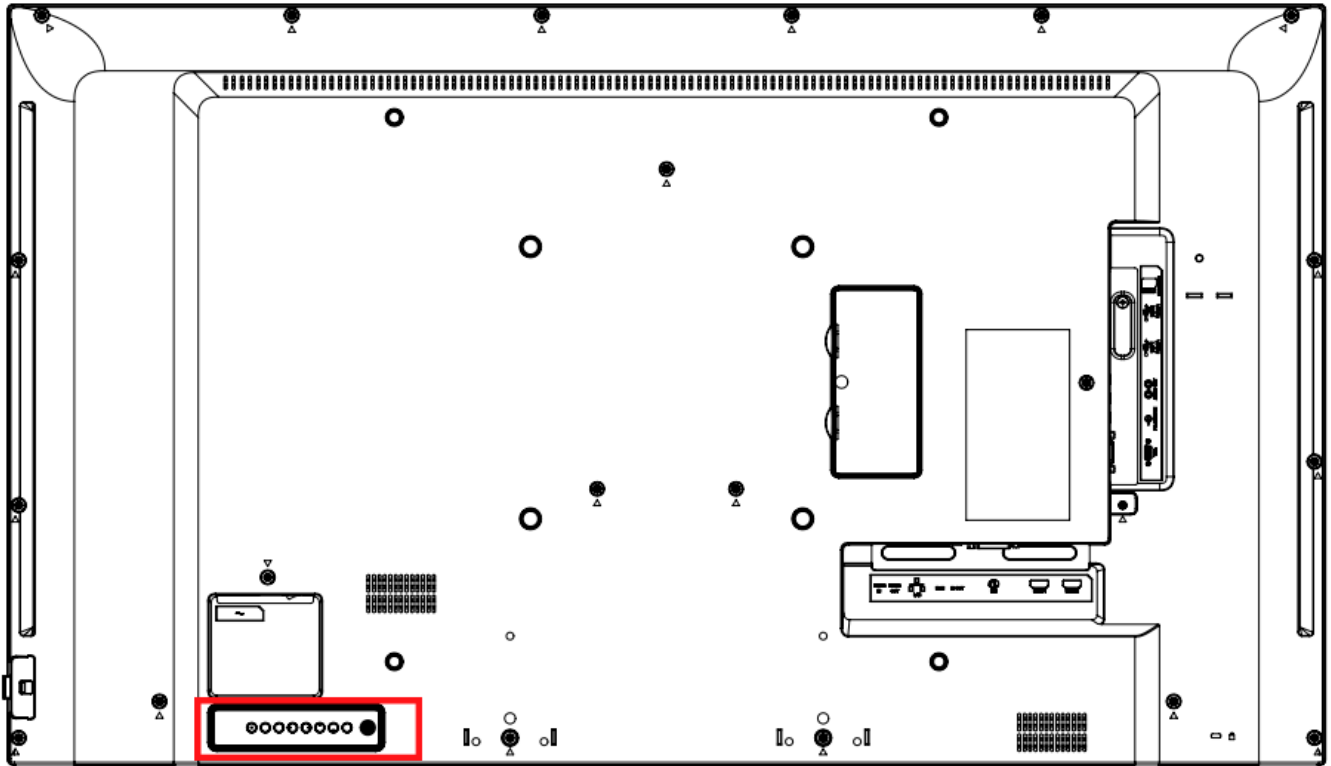

**OSD Keypad Buttons**

Key	Descriptions
Power	Power on / Power off
Mute	Audio Mute
Input	Source Selection
+	Menu Right / Increase value / Volume +
-	Menu Left / Decrease value / Volume -
▲	Menu Up
▼	Menu Down
Menu	Menu open / close

## 11. Remote Control Receiver

The remote control receiver is located near the keypad on the rear of the display. Use the IR extender cable for operating the remote from the front of the display.

**Note:** This product also features an IR reception window. Pull the window out on the SL4364K, and down on all other models, to increase front facing sensor visibility. See the drawings below for reference.

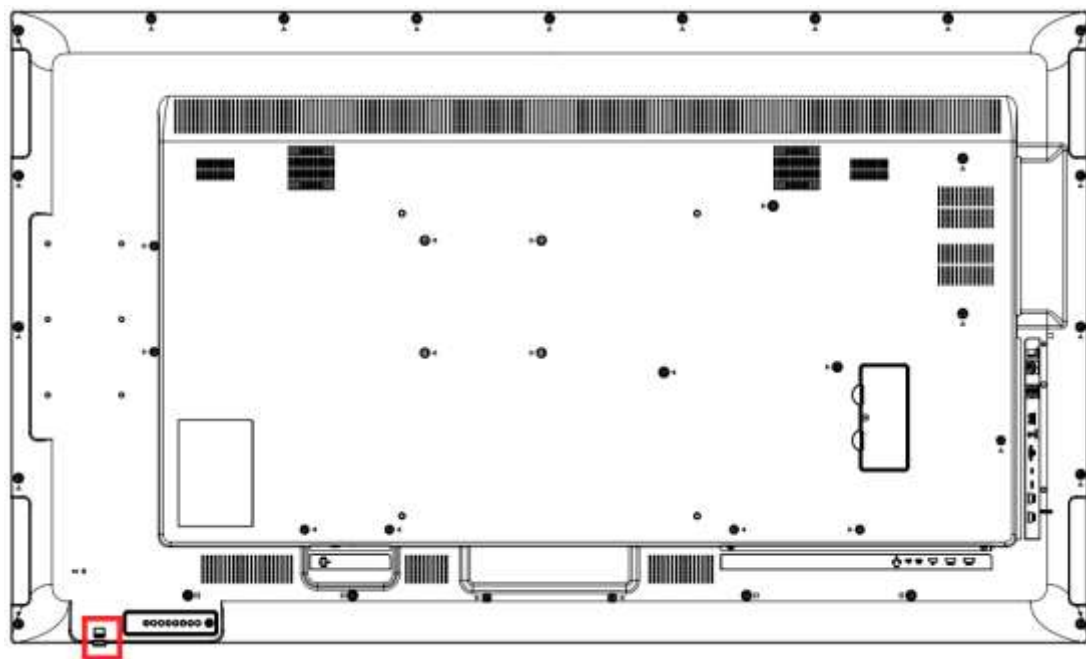
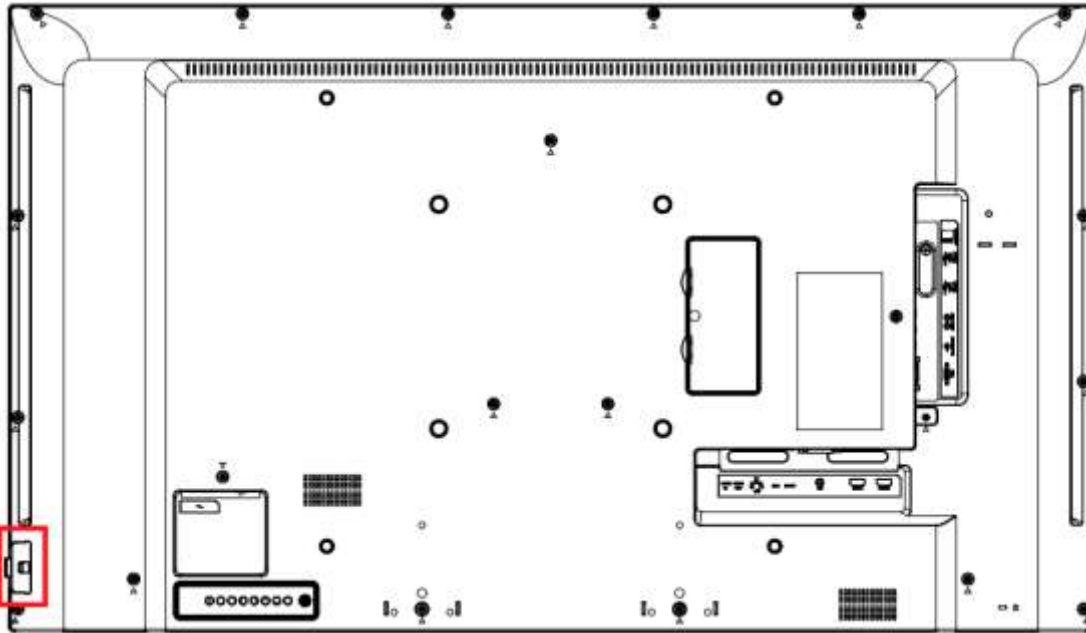

## 12. LED Indicators

The LED indicator light is located on the rear of the display near the keypad. The following table explains what the different colors and blink patterns mean.

LED On	
Power Status	Condition
Green	Power on
Red	Standby Power save mode
Red / Green Blinking	IR codes received
Off	AC off

## 13. Using the Display in Flat or Tilted Orientation

The display is not recommended for use in flat orientation for tabletop, floor, or ceiling installations. LCD panels of this size are at risk of panel deflection, which can cause cosmetic sagging, brightness uniformity issues, and a shortened life span. Installations where the display is tilted downward or upward at an angle may also be prone to these issues and are not recommended.

**Note:** Failure to follow these instructions will void the warranty.



## 14. Using the Remote Control

Below is a picture of the remote control and its corresponding hex codes. Planar Simplicity Series 4K Displays use the RC6 protocol for IR communication.

IR Remote Key Codes		
Key Name	Address	Data
Power	0x00	0x0C
Normal	N/A	N/A
ID	N/A	N/A
◀◀	0x00	0x2B
▶	0x00	0x2C
▶▶	0x00	0x28
■	0x00	0x31
	0x00	0x30
Source	0x00	0x38
Home	0x00	0x54
Format	0x00	0xF5
Back	0x00	0x0A
List	0x00	0xCC
Info	0x00	0x0F
Up	0x00	0x58
Down	0x00	0x59
Left	0x00	0x5A
Right	0x00	0x5B
OK	0x00	0x5C
Adjust	0x00	0x90
Options	0x00	0x40
Vol +	0x00	0x10
Vol -	0x00	0x11
Mute	0x00	0x0D
[Red]	0x00	0x6D
[Green]	0x00	0x6E
[Yellow]	0x00	0x6F
[Blue]	0x00	0x70
1	0x00	0x01
2	0x00	0x02
3	0x00	0x03
4	0x00	0x04
5	0x00	0x05
6	0x00	0x06
7	0x00	0x07
8	0x00	0x08
9	0x00	0x09
0	0x00	0x00
ID Set	N/A	N/A
Enter	N/A	N/A

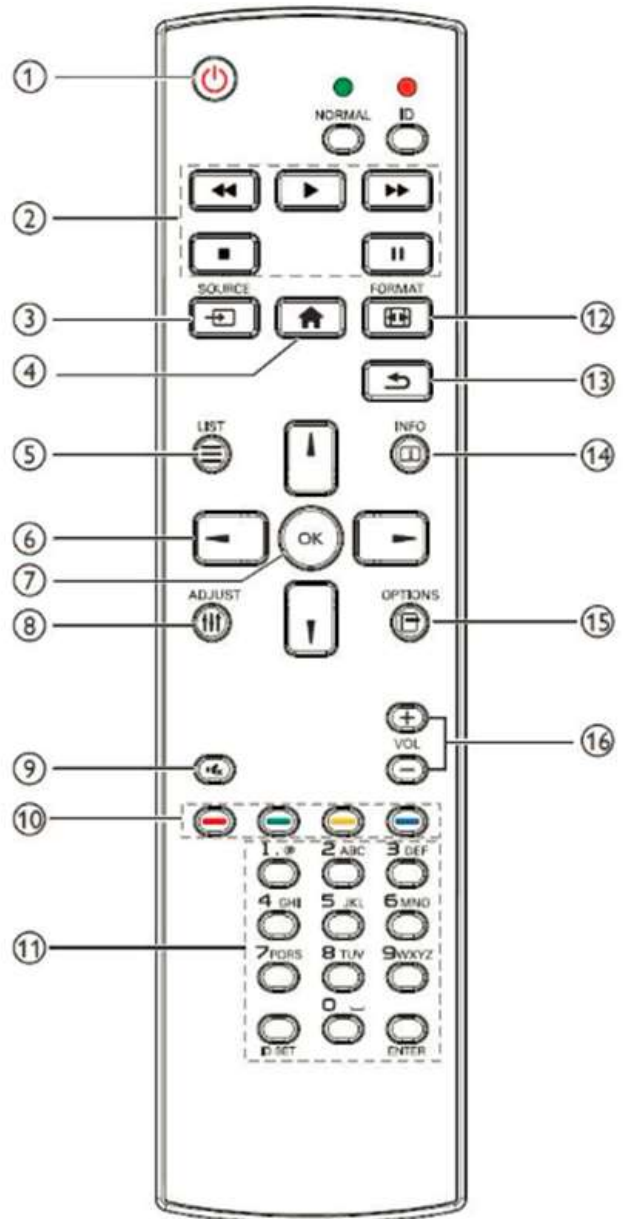

## 15. Pairing the Remote Control to the Display

The remote control can send commands to any display or to one specific display.

**To send commands to all displays:** Hold down the NORMAL button on the remote control until the green LED lights. When NORMAL mode is active, the green LED above the NORMAL button will blink when any key on the remote control is pressed.

**To send commands to only one display:** Hold down the ID button on the remote control until the red LED lights. When the ID mode is active, the red LED above the ID button will blink when any key on the remote control is pressed.

For initial setup of ID mode, perform the following steps:

1. In the OSD, change the Monitor ID setting to a unique value ([see page 45](#)).
2. On the remote control, hold down the ID SET button until the red LED above the ID button turns on.
3. Use the 0-9 keys to enter the same value selected for the Monitor ID setting. Press the ENTER key. The red LED will blink twice to confirm the ID code was successfully accepted. The remote control will automatically change to ID mode.
4. Test that the pairing is successful by pressing a remote control key, such as the HOME key. If the key is not accepted by the display, check the Monitor ID setting in the OSD matches the ID code selected on the remote control.

## 16. Basic Remote Functions

### 16.1 Turning the Display On

1. Insert the power cord into the display and into the power outlet.
2. Ensure the AC switch is set to “—”.
3. Press the power button on the remote or keypad.

### 16.2 Turning the Display Off

With the power on, press the power button on the remote or keypad to put the LCD panel in a standby mode. To turn off power completely, turn the AC switch to “O” or disconnect the AC power cord from the power outlet.

**Note:** If there is no signal for a certain period of time, the LCD panel will automatically go into standby mode.

### 16.3 Adjusting the Volume

1. Using the remote, press the VOL- or VOL+ to increase or decrease the volume.
2. Pressing the MUTE button temporarily turns off all sound. To restore the sound, press the MUTE button again.

**Note:** The analog audio out is variable. S/PDIF is fixed.

### 16.4 Selecting the Input Source

Press the SOURCE button on the remote or press the INPUT button on the keypad. Use the arrow buttons to select one of the following input sources and press OK:

- SL4364K, SL5064K, and SL5564K: HDMI 1, HDMI2, DVI, VGA, Media Player
- SL6564K, SL7564K and SL8664K: HDMI 1, HDMI 2, HDMI 3, HDMI 4, DisplayPort, VGA, OPS, Media Player

**Note:** When the display cannot find a source, a “No signal” message will appear.

### 16.5 Navigating Through the Menus

1. With the power on, press MENU. The main menu appears.
2. Within the menu, use ▲, ▼, ◀, ▶, and OK to navigate through the menus and adjust options.
3. Press BACK to return to the previous menu. To exit the menu system, press HOME.

## 17. OSD Initial Settings Menu

Use this menu to make initial setup adjustments to the OSD (On-Screen Display) menu and other on-screen messages.

When this display is turned on for the first time, initial set-up is required. This process is outlined in the following Initial Configuration section.

### 17.1 Initial Configuration / Importing Settings

#### Welcome Page

1. Select a language and press start.

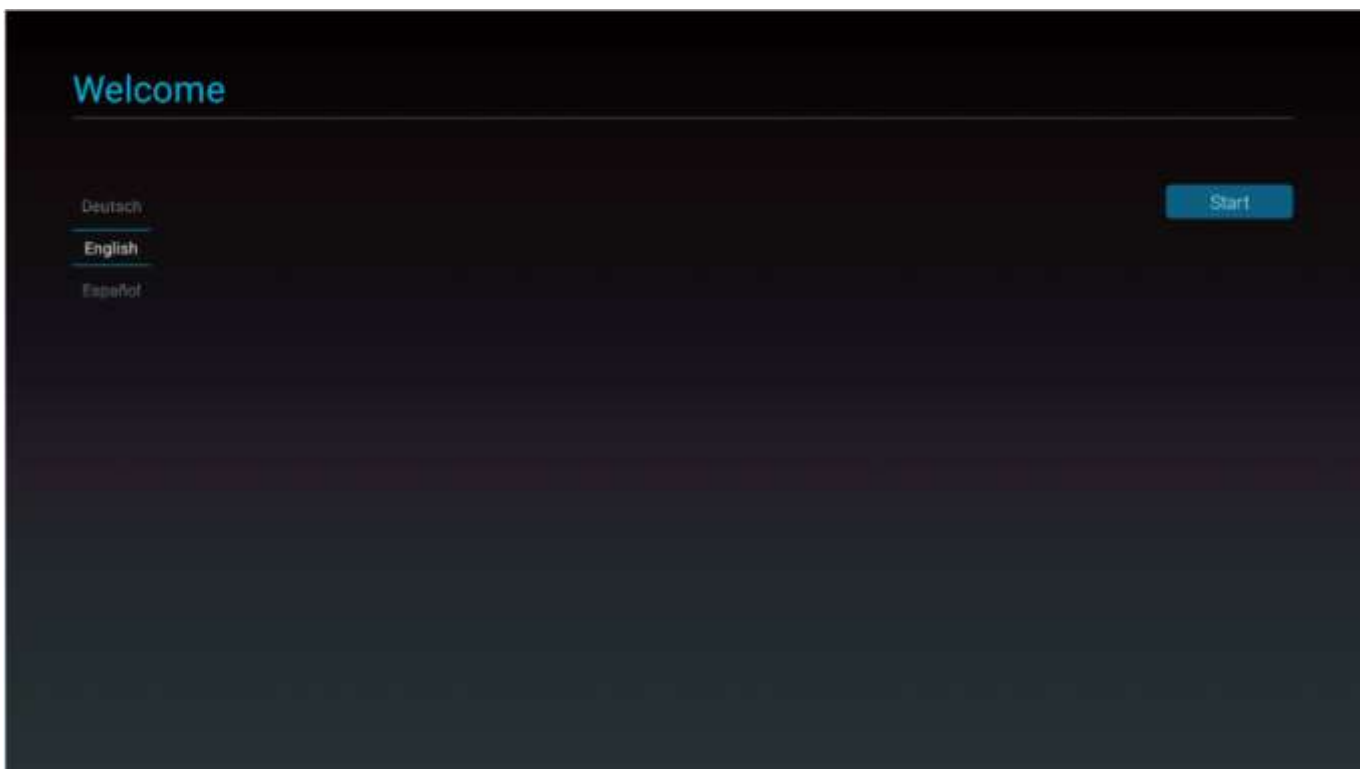

## Network Setting

2. If using the network connection, press Next to set up.

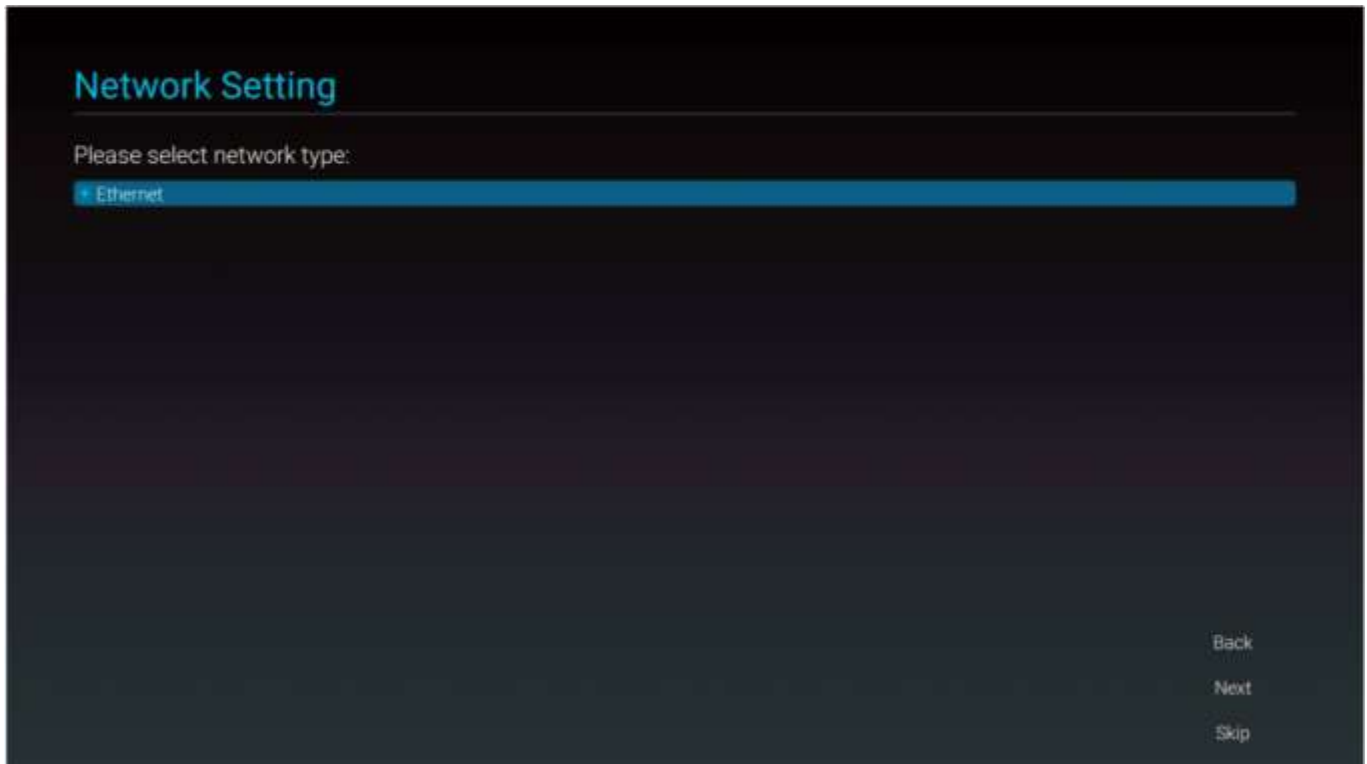

3. Otherwise, press Skip to advance to the next topic.

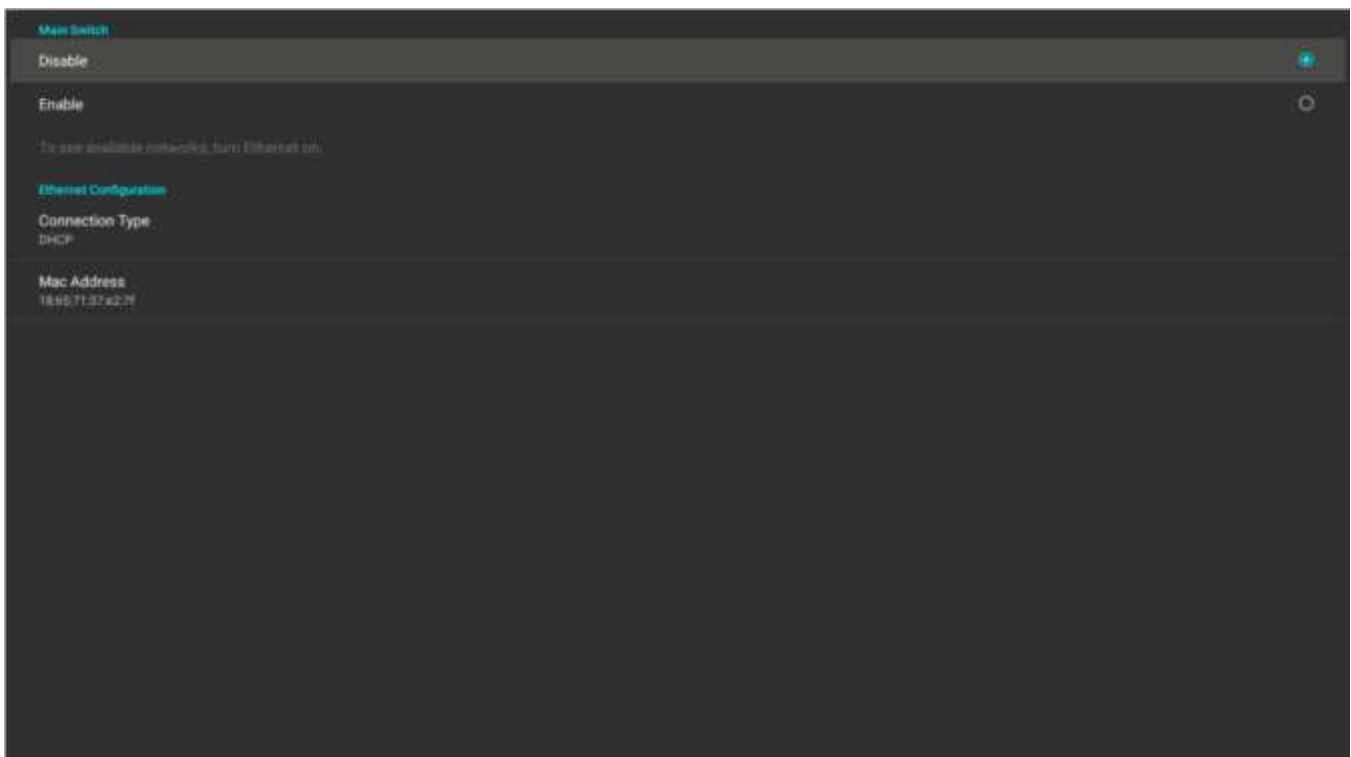

4. Select Connection Type to configure your IP settings. Press save when complete.
5. When finished, select Enable to complete setup. Press the Return key on the remote control if enabling the network connection is not desired.

## Signage Display Settings

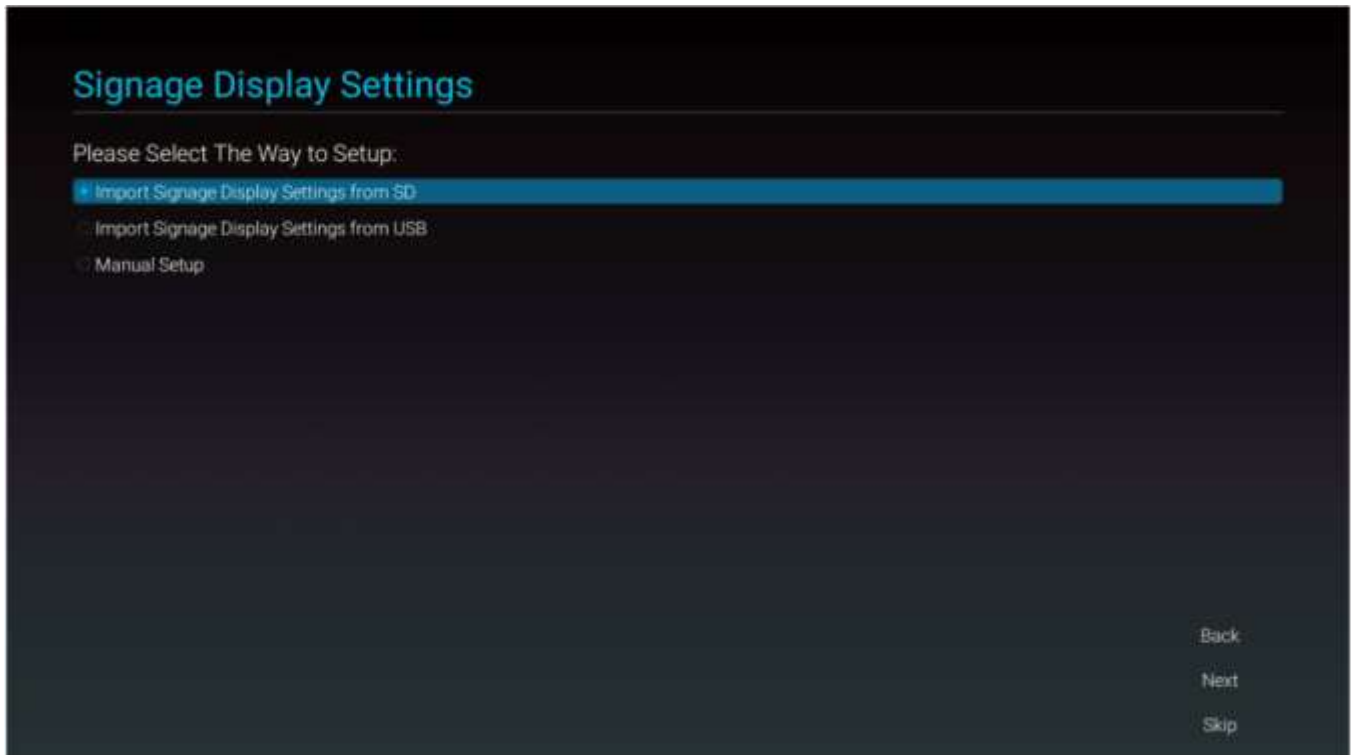

6. Use one of the following setup options:
  - a. Import Signage Settings from SD.
    - i. Use settings previously saved to an SD card using the Export Signage Display Settings in the Android OSD ([see page 56](#)). This will import all settings except for the Signage Display Name field.
  - b. Import Signage Display Settings from USB
    - i. Use settings previously saved to a USB storage device using the Export Signage Display Settings in the Android OSD ([see page 56](#)). This will import all settings except for the Signage Display Name field.
  - c. Manual Setup
    - i. Signage Display Name
      1. Assign a name to the display. By default, this is “PD\_” plus the MAC address of the display.

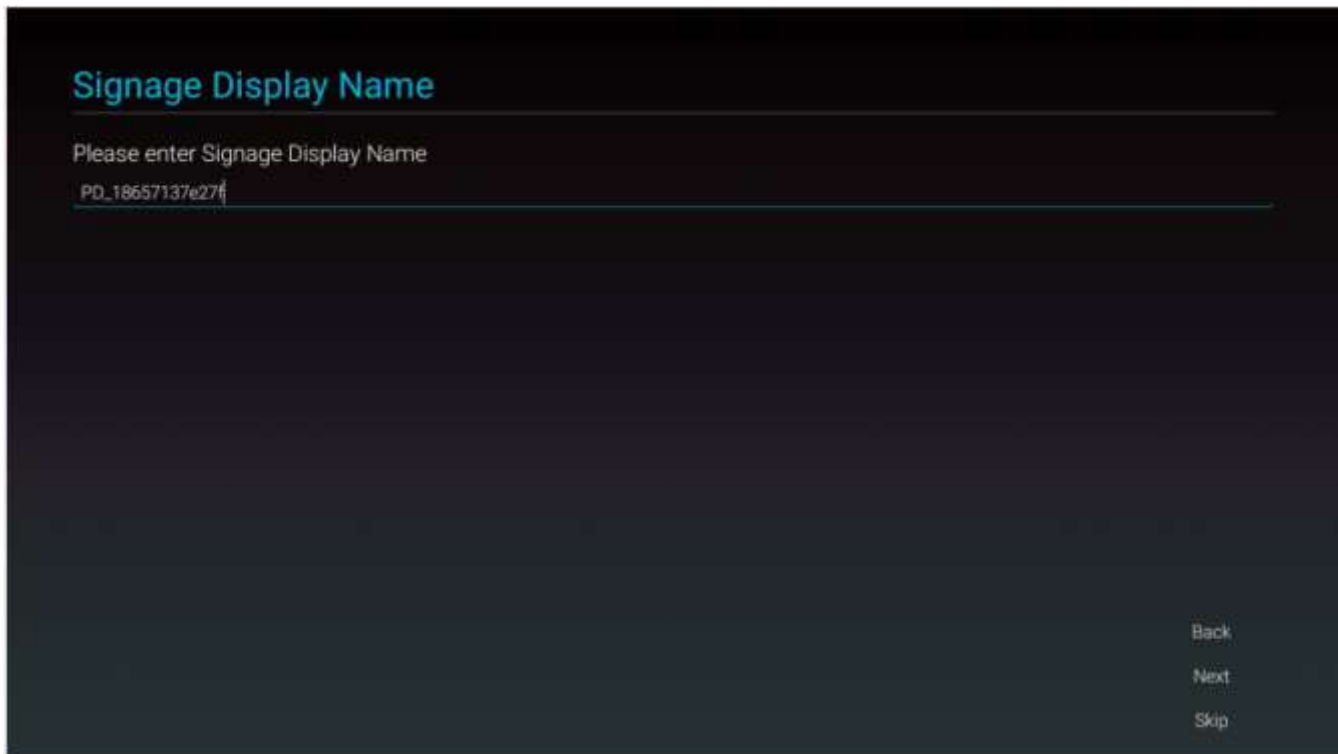

ii. Clone Media Files

1. Import media files previously saved to an SD card or USB storage device using the Clone Media Files feature in the Android OSD ([see page 57](#)).

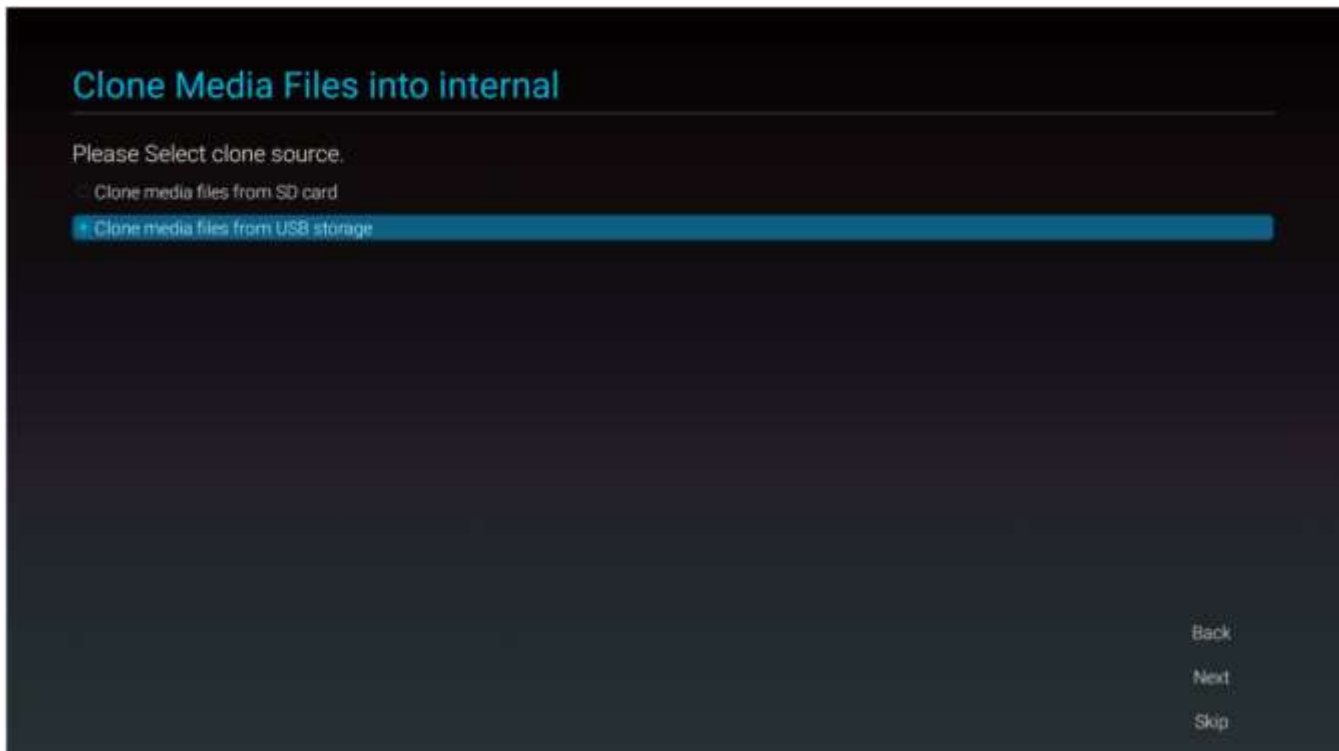

## Setup Complete

7. Initial configuration is now complete. Press finish to begin using the display.

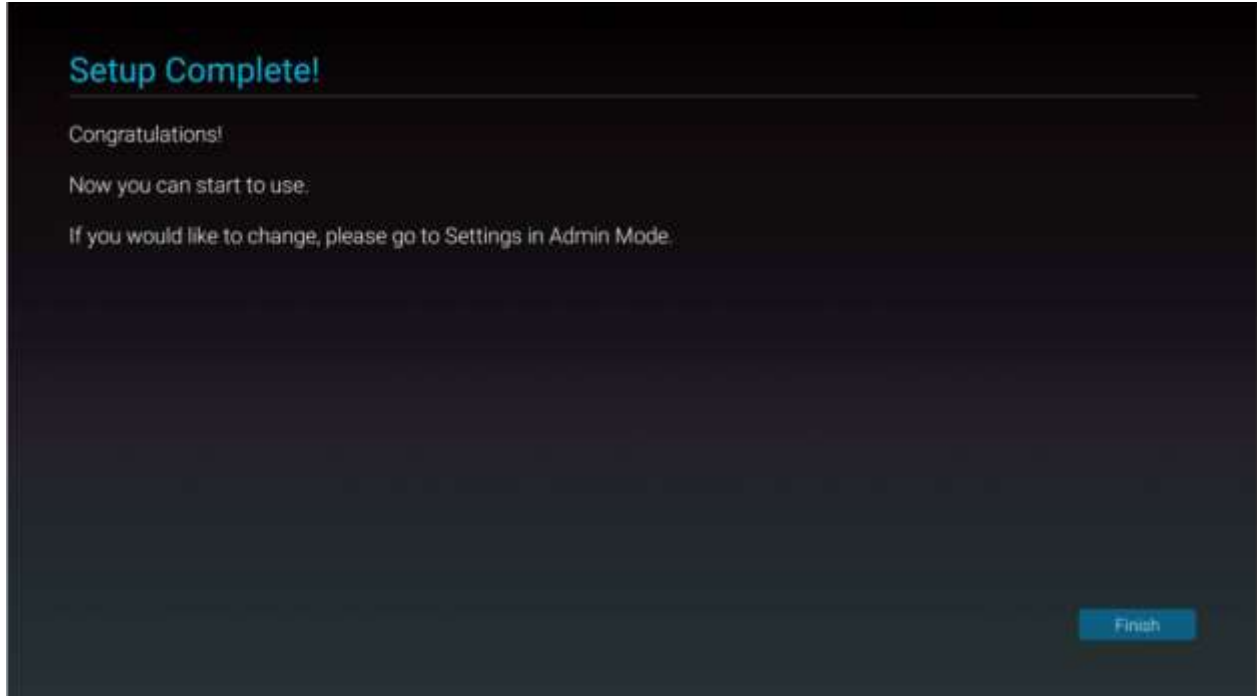



## 18. Input Menu

Below are the menus used for selecting the input sources for all models:

**SL4364K, SL5064K, and SL5564K**

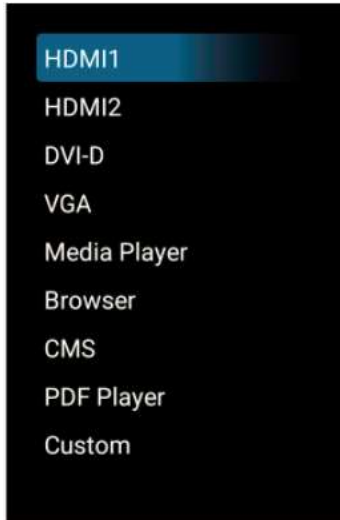

**SL6564K, SL7564K, and SL8664K**

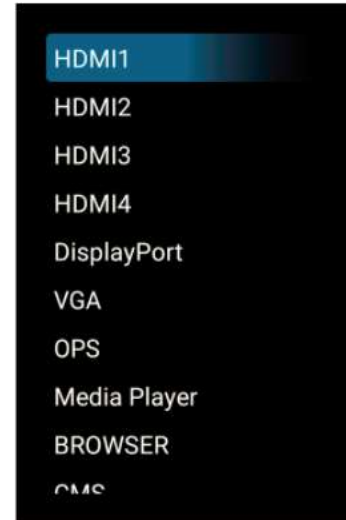

### 18.1 Source Options

SL4364K, SL5064K, and SL5564K

- Options: HDMI 1, HDMI 2, DVI-D, VGA, Media Player, Browser, CMS, PDF Player, Custom

SL6564K, SL7564K, and SL8664K

- Options: HDMI 1, HDMI 2, HDMI 3, HDMI 4, DisplayPort, VGA, OPS, Media Player, Browser, CMS, PDF Player, Custom

## 19. OSD Main Menu

### 19.1 Picture

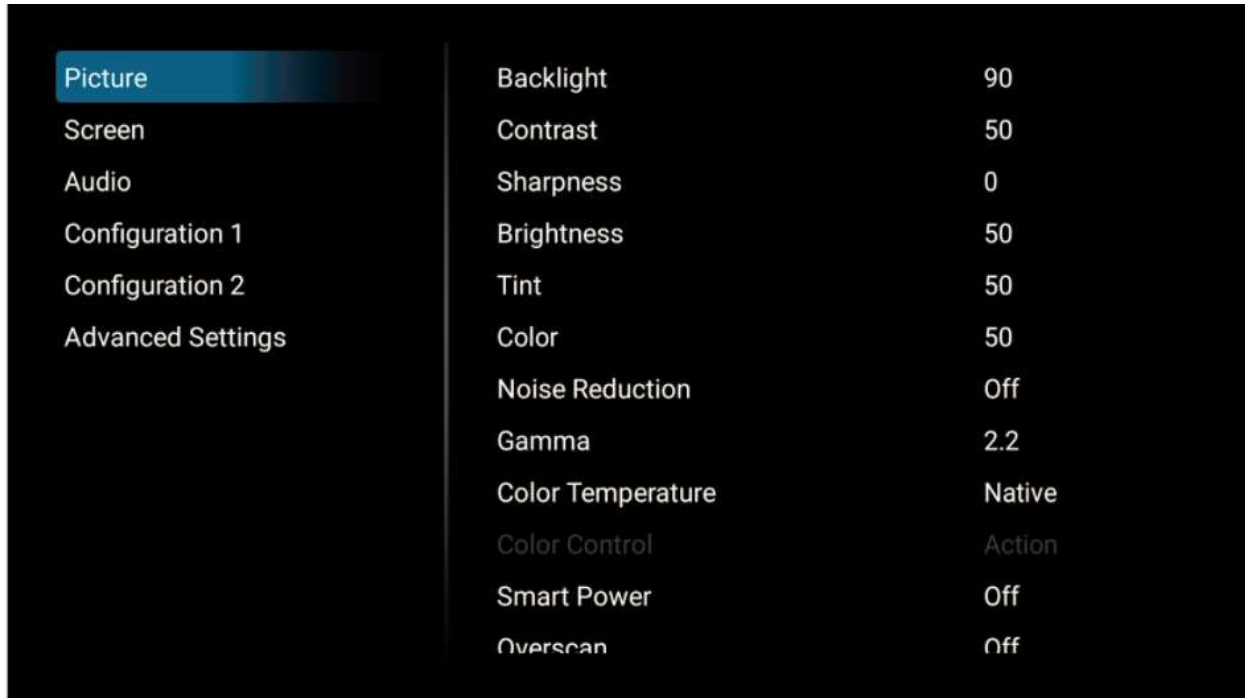

#### Backlight

- Increase or decrease the intensity of the LCD backlight. Press ◀ or ▶ to select the desired level.
- **Range:** 0~100
- **Default:** 90

#### Contrast

- Increase or decrease the contrast of the picture. Press ◀ or ▶ to select the desired level.
- **Range:** 0~100
- **Default:** 50

#### Sharpness

- Adjust the definition of the picture. Press ◀ or ▶ to select the desired level.
- **Range:** 0~100
- **Default:** 0

#### Brightness

- Increase or decrease the brightness of the picture. Press ◀ or ▶ to select the desired level.
- **Range:** 0~100
- **Default:** 50

### Tint

- Increase or decrease the green hue. Press ◀ or ▶ to select the desired level
- **Range:** 0~100
- **Default:** 50

### Color

- Adjust the brilliance and brightness. Press ◀ or ▶ to select the desired level
- **Range:** 0~100
- **Default:** 50

### Noise Reduction

- Reduce random noise in video content
- **Options:** Options: Off, Low, Medium, High
- **Default:** Off

### Gamma

- Select gamma.
- **Options:** Native, 2.2, 2.4, S gamma, D-image
- **Default:** 2.2

### Color Temperature

- Select color temperature.
- **Options:** 3000K, 4000K, 5000K, 6500K, 7500K, 9300K, 10000K, Native, User 1, User 2
- **Default:** Native

### Color Control

- Red Gain
  - Adjust the amount of red in bright content. Press ◀ or ▶ to select the desired level.
  - **Range:** 0~255
  - **Default:** 128
- Green Gain
  - Adjust the amount of green in bright content. Press ◀ or ▶ to select the desired level.
  - **Range:** 0~255
  - **Default:** 128
- Blue Gain
  - Adjust the amount of blue in bright content. Press ◀ or ▶ to select the desired level.
  - **Range:** 0~255
  - **Default:** 128



#### Smart Power

- Automatically adjust the image settings in order to reduce power consumption
- Options: Off, Medium, High
- Default: Off

#### Overscan

- Adjust the zoom (overscan) of the image.
- **Options:** Off, On
- **Default:** Off

#### Picture Reset

- Reset all setting in the Picture menu to their default values.

## 19.2 Screen

Picture	H position	50
Screen	V position	50
Audio	Tracking	50
Configuration 1	Clock phase	60
Configuration 2	Zoom mode	Custom
Advanced option	Custom zoom	Action
	Auto adjust	Action
	Screen reset	Action

### H Position

- Adjust the horizontal position of the image (VGA source only). Press ◀ or ▶ to select the desired level.
- **Range:** 0~100
- **Default:** 50

### V Position

- Adjust the vertical position of the image (VGA source only). Press ◀ or ▶ to select the desired level.
- **Range:** 0~100
- **Default:** 50

### Tracking

- Adjust the clock of the displayed signal (VGA source only). Press ◀ or ▶ to select the desired level.
- **Range:** 0~100
- **Default:** 50

### Phase

- Adjust the phase of the displayed signal (VGA source only). Press ◀ or ▶ to select the desired level.
- **Range:** 0~100
- **Default:** 50

## Aspect Ratio

- Adjust the aspect ratio of the screen.
- **Options:** Fill, 4:3, Native, 16:9, Letterbox, Custom
- **Default:** Fill



## Custom Zoom

- Zoom
  - Adjust the zoom (overscan) of the image. Available when Aspect Ratio is set to Custom. Press ◀ or ▶ to select the desired level.
  - **Range:** 0~100
  - **Default:** 0
- H Zoom
  - Adjust the zoom (overscan) of the image in the horizontal direction only. Available when Aspect Ratio is set to Custom. Press ◀ or ▶ to select the desired level.
  - **Range:** 0~100
  - **Default:** 0
- V Zoom
  - Adjust the zoom (overscan) of the image in the vertical direction only. Available when Aspect Ratio is set to Custom. Press ◀ or ▶ to select the desired level.
  - **Range:** 0~100
  - **Default:** 0
- H Position
  - Adjust the horizontal position of the image (VGA source only). Available when Aspect Ratio is set to Custom. Press ◀ or ▶ to select the desired level.
  - **Range:** 0~100
  - **Default:** 50

- V Position
  - Adjust the vertical position of the image (VGA source only). Available when Aspect Ratio is set to Custom. Press ◀ or ▶ to select the desired level.
  - **Range:** 0~100
  - **Default:** 50

#### Auto Adjust

- Force the display to reacquire and lock to the input signal (VGA source only). This is useful when the signal quality is marginal.
- **Note:** This feature does not continually reacquire the signal.

#### Screen Reset

- Reset all settings in the Screen menu to their default values.

## 19.3 Audio

Picture	Balance	50
Screen	Treble	50
Audio	Bass	50
Configuration 1	Volume	20
Configuration 2	Audio Out(Line Out)	20
Advanced Settings	Maximum Volume	100
	Minimum Volume	0
	Mute	Off
	Audio Source	Digital
	Audio Reset	Action
	Audio Out Sync	Off

### Balance

- Adjust the balance of the left and right speakers. Press ◀ or ▶ to select the desired level.
- **Range:** 0~100
- **Default:** 50

### Treble

- Adjust the sound in high tones. Press ◀ or ▶ to select the desired level.
- **Range:** 0~100
- **Default:** 50

### Bass

- Adjust the sound in low tones. Press ◀ or ▶ to select the desired level.
- **Range:** 0~100
- **Default:** 50

### Volume

- Adjust the sound. Press ◀ or ▶ to select the desired level.
- **Range:** 0~100
- **Default:** 20



### Audio Out (Line Out)

- Adjust the sound on the L/R audio outputs. Available if Audio Out Sync is set to Off. Press ◀ or ▶ to select the desired level.
- **Range:** 0~100
- **Default:** 20

### Maximum Volume

- Limit the maximum value of the Volume control. Press ◀ or ▶ to select the desired level
- **Range:** 0~100
- **Default:** 100

### Minimum Volume

- Limit the minimum value of the Volume control. Press ◀ or ▶ to select the desired level
- **Range:** 0~100
- **Default:** 0

### Mute

- Turn off the sound.
- **Options:** Off, On
- **Default:** Off

### Audio Source

- Select the audio source to play through the display's internal speakers and audio outputs
- **Options:** Analog, Digital
- **Default:** Analog for VGA, Digital for all other sources

### Audio Reset

- Reset all settings in the Audio menu to their default values.

### Audio Out Sync

- Choose whether the internal speakers and audio out use the same volume control, or separate controls.
- **Options:** Off, On
- **Default:** Off

## 19.4 Configuration 1

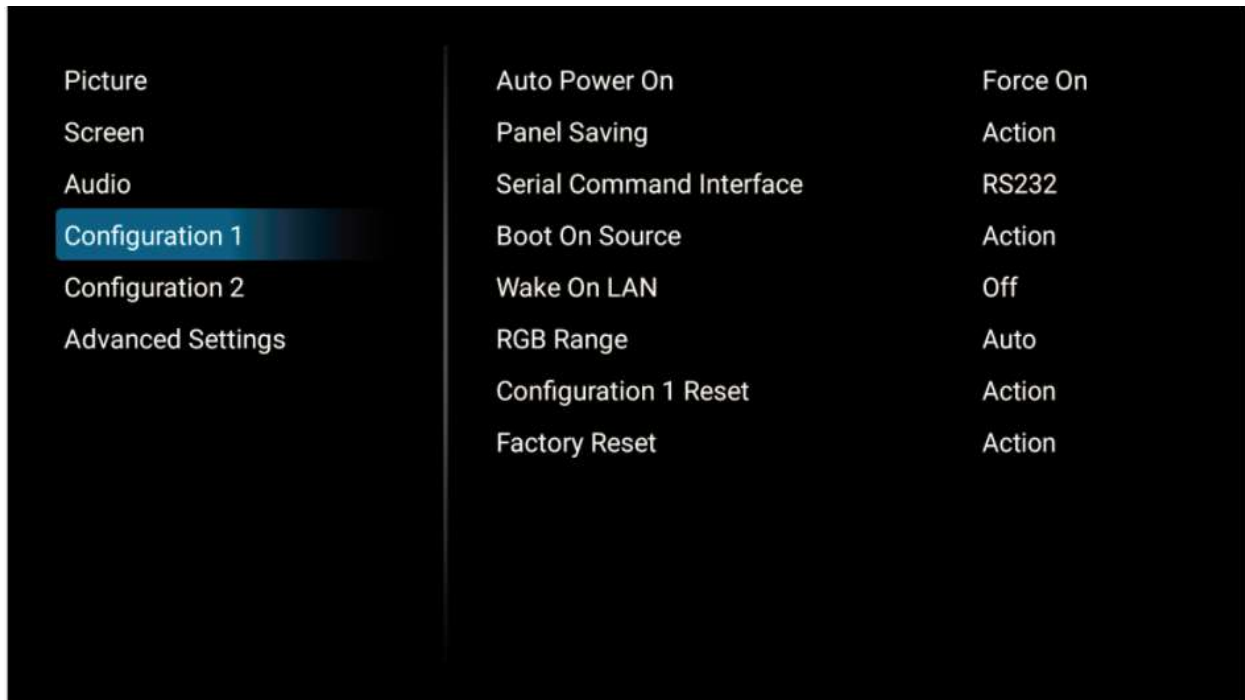

### Auto Power On

- Select the behavior of the display when AC power is turned on
- **Options:** Power off, Force on, Last status
- **Default:** Force on

### Panel Saving



- Brightness
  - Automatically limit the backlight intensity in order to reduce power consumption
  - **Options:** Off, On
  - **Default:** Off
- Pixel Orbit
  - Create slight frame motion to help avoid image retention
  - **Options:** Off, On
  - **Default:** Off

#### Serial Command Interface

- Select whether to use the RS232 input or the LAN input for serial commands. Only one connection can be active.
- **Options:** RS232, LAN, OPS RS232 (SL6564K, SL7564K, SL8664K)
- **Default:** RS232

#### Boot On Source

- Select the source to display on power up.
- **Options:**
  - SL4364K, SL5064K, SL5564K: Last Input, DVI-D, VGA, HDMI 1, HDMI 2, Media Player, Browser, CMS, PDF Reader, Custom
  - SL6564K, SL7564K, SL8664K: Last Input, DisplayPort, VGA, OPS, HDMI 1, HDMI 2, HDMI 3, HDMI 4, Media Player, Browser, CMS, PDF Reader, Custom
- **Default:** Last Input

#### Wake On LAN

- Allow the display to wake up with a network message.
- **Options:** Off, On
- **Default:** Off

#### RGB Range

- Select RGB range for HDMI and DisplayPort sources.
- **Options:** Auto, Full, Limited
- **Default:** Auto

#### Configuration 1 Reset

- Reset all settings in the Configuration 1 menu to their default values.

#### Factory Reset

- Reset all settings in all menus to their default values.

## 19.5 Configuration 2

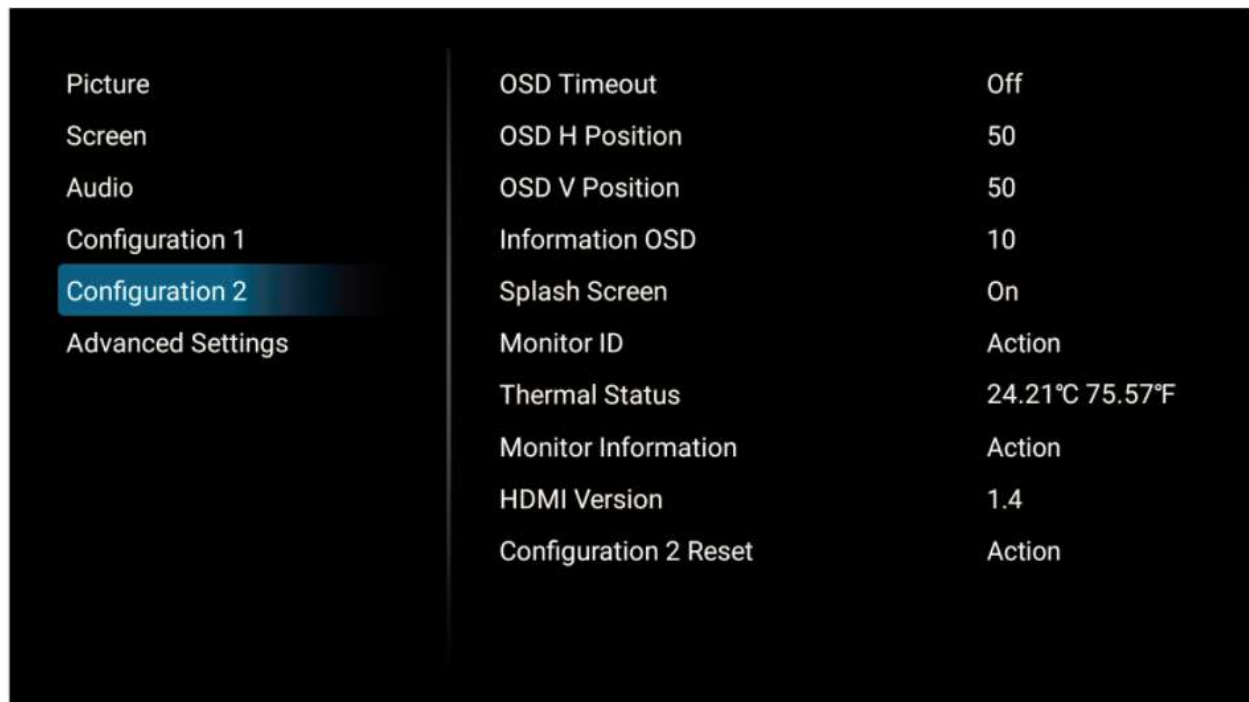

### OSD Timeout

- Adjust the time in seconds before the OSD menu disappears. Press ◀ or ▶ to select the desired level.
- **Range:** Off, 5~120 seconds
- **Default:** 45

### OSD H Position

- Adjust the horizontal position of the OSD menu. Press ◀ or ▶ to select the desired level.
- **Range:** 0~100
- **Default:** 50

### OSD V Position

- Adjust the vertical position of the OSD menu. Press ◀ or ▶ to select the desired level.
- **Range:** 0~100
- **Default:** 50

### Information OSD

- Select whether the information message box displays on the screen, and for how long. Press ◀ or ▶ to select the desired level.
- Options: Off, 1~60 seconds
- Default: 10

### Splash Screen

- Select whether a splash screen appears when the monitor powers up.
- **Options:** Off, On
- **Default:** On

### Monitor ID

- Select the ID code to use with an IR remote control in ID mode. See [page 26](#) for more info. Press ◀ or ▶ to select the desired level.
- **Options:** 1~255
- **Default:** 1

### Thermal Status

- Read the internal temperature of the display

### Monitor Information

- This read-only menu provides information on the display and its firmware version



### HDMI Version

- Select the HDMI version of the HDMI inputs
- **Options:** 1.4, 2.0
- **Default:** 2.0
- **Note:** HDMI 2.0 is the more modern standard and supports 3840x2160 @ 60Hz resolution. However, sometimes HDMI 1.4 is needed for compatibility with older devices.

### Configuration 2 Reset

- Resets all settings in the Configuration 2 menu to their default values

## 19.6 Advanced Settings

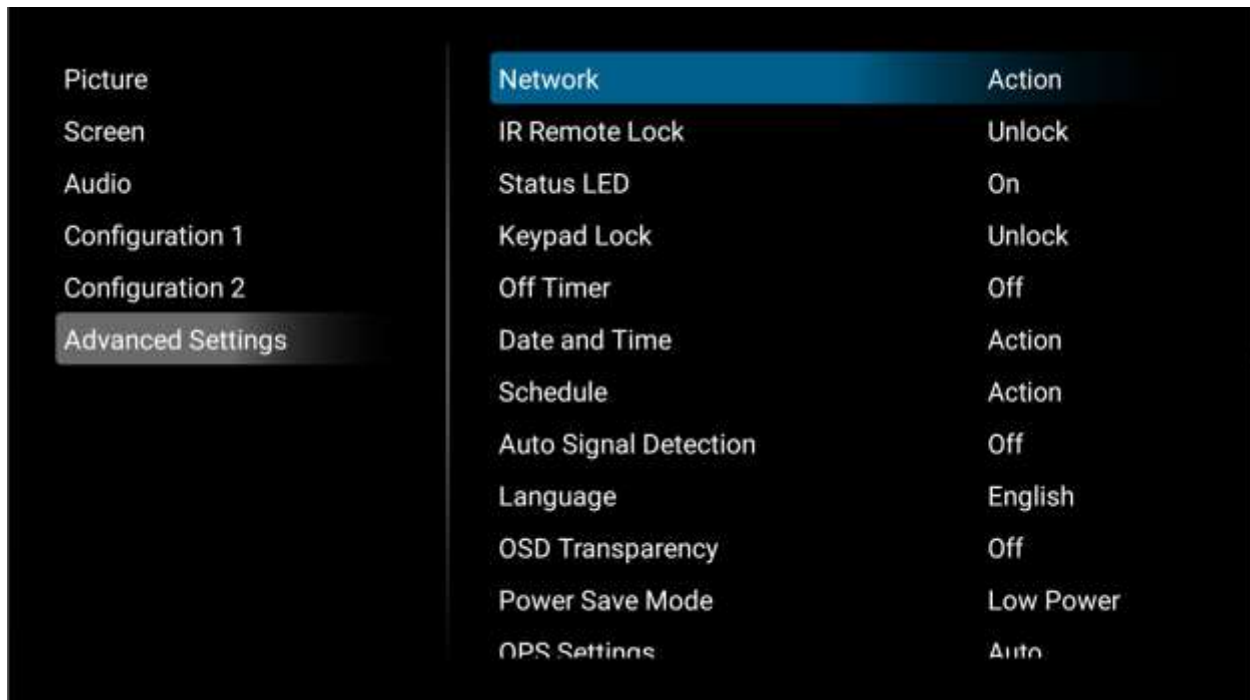

### Network

- Opens the Ethernet settings menu. See [page 51](#) for more information.

### IR Remote Lock

- Lock or unlock IR remote control functionality. To disable the IR remote lock, press the Info key for 10 seconds.
- **Options:** Unlock, Lock All, Lock all but Volume, Lock All but Power, Lock All Except PWR & VOL, Primary, Secondary
- **Default:** Unlock

### Status LED

- Enable or disable the status LED
- **Options:** Off, On
- **Default:** On

### Keypad Lock

- Lock or unlock the keypad controls
- **Options:** Unlock, Lock All, Lock all but Volume, Lock All but Power, Lock All Except PWR & VOL
- **Default:** Unlock

## Off Timer

- Force the display to enter standby mode after the specified period of time. Press ◀ or ▶ to select the desired level.
- **Options:** Off, 1~24 hours
- **Default:** Off

## Date and Time

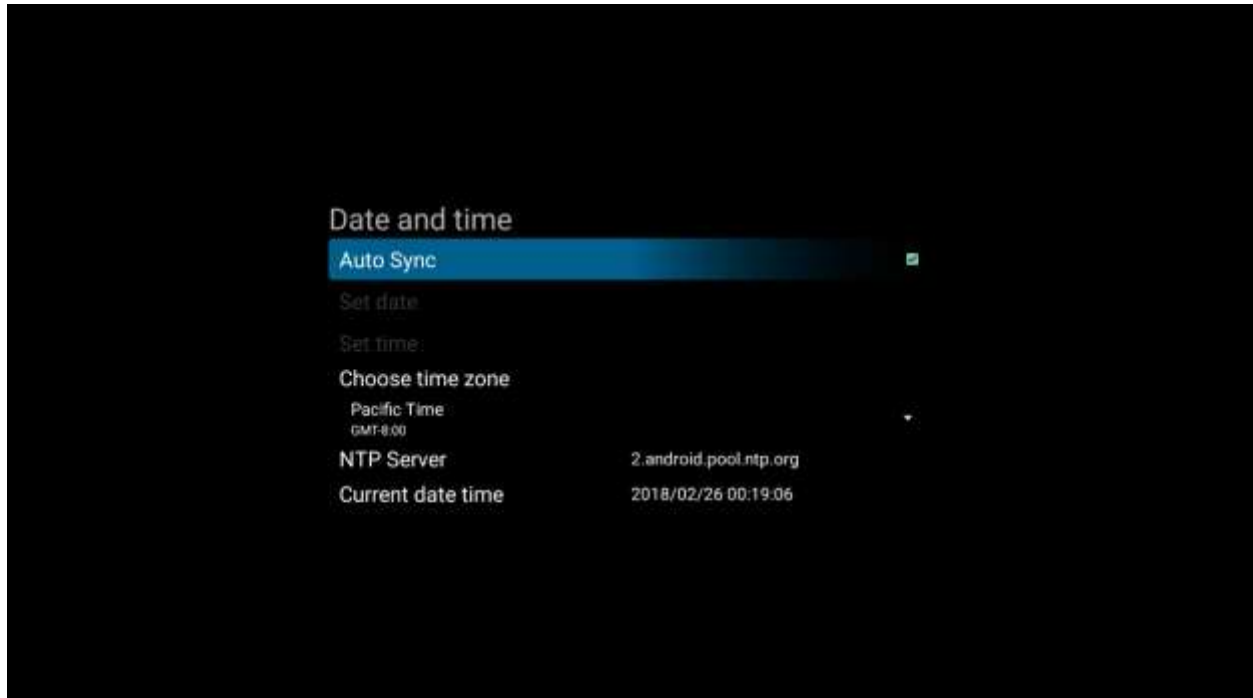

- Auto Sync
  - Automatically obtain the current date and time information from an NTP server.
  - **Options:** Off, On
  - **Default:** On
- Set Date
  - Set the current date. Available when Auto Sync is set to Off.
- Set Time
  - Set the current time. Available when Auto Sync is set to Off.
- Choose Time Zone
  - Set the current time zone
- NTP Server
  - Lists the NTP server that will be used to automatically obtain the current date and time.
- Current Date and Time
  - Displays the current date and time configured in the display.

## Schedule

- This menu is used to configure schedules for powering on and powering off the display at preset times. Up to seven different schedules can be set.

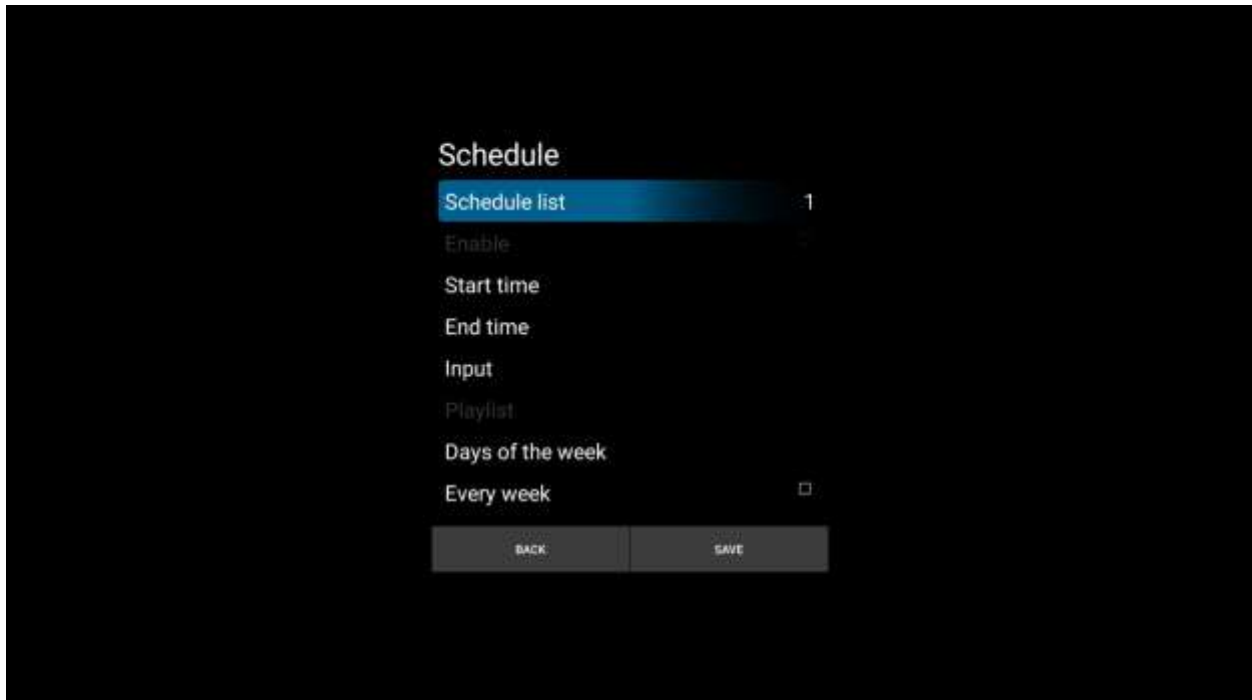

- Schedule List
  - Select the schedule preset to configure.
  - **Range:** 1~7
  - **Default:** 1
- Enable
  - Make the selected schedule active. Available when Start Time, End Time, Input, Playlist (Media Player source only) and Days of the Week are configured.
  - **Options:** Off, On
  - **Default:** Off
- Start Time
  - Set the time when the display will power on.
- End Time
  - Set the time when the display will enter standby mode.
- Input
  - Select the source to display when the unit powers on.
- Playlist
  - Select the playlist to show when the display powers on (Media Player source only).
- Days of the Week
  - Select which days of the week the selected schedule is active.
  - **Options:** Sun, Mon, Tue, Wed, Thu, Fri, Sat
  - **Default:** None



- Every Week
  - Indicate whether the schedule is for the current week only, or for every week going forward.
  - **Options:** Off, On
  - **Default:** Off

#### Auto Signal Detection

- Automatically searches all inputs for a signal
- **Note:** The following sources are not included in the search: Media Player, Browser, CMS, PDF Player, Custom)
- **Options:** Off, On
- **Default:** Off

#### Language

- Select the OSD language
- **Options:** English, French, German, Spanish, Italian, Simplified Chinese, Traditional Chinese, Japanese, Portuguese
- **Default:** English

#### OSD Transparency

- Adjust the transparency of the OSD menu. Press ◀ or ▶ to select the desired level.
- Options: Off, 5~100 percent
- Default: Off

#### Power Save Mode

- Select the behavior of the unit when no signal is detected
- **Options:** Low Power, Wake on Signal, Always On
- **Default:** Low Power

#### Advanced Settings Reset

- Resets all settings in the Advanced Settings menu to their default values

## 20. OSD Android Settings Menu

### 20.1 Android Main Menu

To access the Android menu, open the Source menu and select Custom.



**Note:** In firmware versions prior to FB01.10, you must instead enter the following key sequence to enter the Android menu: HOME, 1, 6, 6, 8. In firmware versions FB1.10 and later, no code is required.

**Note:** In addition to the IR remote control, use a USB keyboard and mouse to navigate the Android menu and modify settings.

### 20.2 Settings



#### Ethernet

- Main Switch
  - Enable the network interface
  - **Options:** Disable, Enable
  - **Default:** Disable



- Ethernet Configuration
  - Connection Type
    - Enable dynamic IP mode or configure the static IP settings of the display's Ethernet port.
    - **Options:** DHCP, Static IP
    - **Default:** DHCP
  - IP Address
    - The IP address used by the display's network interface.
    - Configurable if Connection Type is set to Static IP.
  - Netmask
    - The subnet mask used by the display's network interface.
    - Configurable if Connection Type is set to Static IP.
  - DNS Address
    - The address of the DNS server used by the display's network interface.
    - Configurable if Connection Type is set to Static IP.
  - Gateway
    - The default gateway used by the display's network interface.
    - Configurable if Connection Type is set to Static IP.
- MAC Address
  - The MAC address of the display's network interface.

## Signage Display

- Signage Display Name
  - Assign a name to the display. By default, this is "PD\_" plus the MAC address of the display.



- Boot Logo
  - Not supported
- Screenshot
  - This menu allows the current image on the display to be captured periodically, saved in internal memory, and optionally e-mailed to the selected address.



- Main Switch
  - Enable or disable automatic collection of screenshots
  - **Options:** Disable, Enable
  - **Default:** Disable

- Interval
  - Timeframe in between screenshot captures
  - **Options:** 30 minutes, 60 minutes
  - **Default:** 30 minutes
- Start Time
  - Time to start capturing screenshots
- End Time
  - Time to stop capturing screenshots
- Repeat
  - Select which days to capture screenshots
  - **Options:** Sunday, Monday, Tuesday, Wednesday, Thursday, Friday, Saturday
  - **Default:** None
  - Save To
    - Read-only field that indicates screenshots will be stored in internal memory
  - Purge Screenshots
    - Select screenshot deletion frequency
    - **Options:** Every Day, Every Week
    - **Default:** Every Day
  - Send Screenshots via Email
    - Select whether to email captured screenshots. See email setup in the Simple Mail Transfer Protocol section below.
    - **Options:** Disabled (unchecked), Enabled (checked)
    - **Default:** Disabled (unchecked)
- Email Notification
  - This menu configures a Simple Mail Transfer Protocol (SMTP) server for sending status information from the display via e-mail.



- Main Switch
  - Enable or disable e-mail functionality
  - **Options:** Disable, Enable
  - **Default:** Enable
- SMTP

- Use this menu to enter the Simple Mail Transfer Protocol (SMTP) server settings. Ask your network administrator or ISP to provide the correct settings for the following fields.

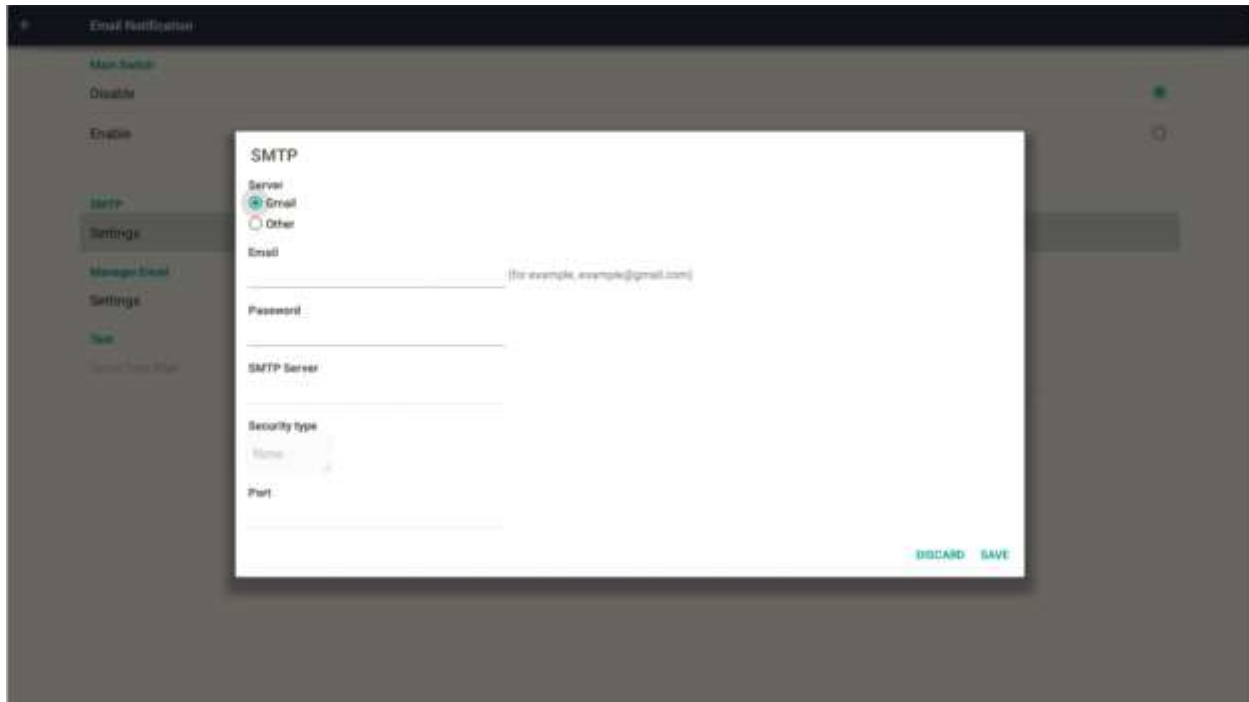

- Server
  - Select whether a Gmail server or another server will be used
  - **Note:** Using Gmail requires enabling support for less secure apps in your Gmail account. Consult your Gmail settings for more information.
- Email
  - Specify the email account that will send messages
- Password
  - The password for the e-mail account
- SMTP Server
  - The SMTP server name or address associated with the e-mail account
- Security Type
  - The type of security for the SMTP connection
  - **Options:** None, SSL, TLS, STARTTLS
  - **Default:** None
- Port
  - The port for the SMTP connection. Typically, this is port 25.
- Manager Email
  - Specify the email address that will receive notifications
- Send Test Mail
  - Test the SMTP settings to confirm they are configured properly

- FTP
  - Configures File Transfer Protocol (FTP) access to the display's file system.
  - Main Switch
    - Enable or disable FTP functionality
    - **Options:** Disable, Enable
    - **Default:** Enable
  - Account
    - FTP login name
    - **Default:** smartcms
  - Password
    - FTP login password
    - **Default:** smartcms
  - Storage Path
    - Read-only indication showing that the FTP storage location is the internal memory
  - Port
    - The port for the FTP connection.
    - **Range:** 1025~65535
    - **Default:** 2121
  
- SICP Network Port
  - Not supported
  
- Media Player
  - Enters the Media Player configuration menu. See [page 64](#) for more information.
  
- Browser
  - Enters the browser's configuration menu.
  
- CMS
  - Configures the connection to a Content Management Software (CMS) server, for downloading content to the display.
  - Server
    - The IP address for the CMS server. Available for entry when the Version field is set to Ver. 3.
  - Account
    - The account name for the CMS server. Obtain this from the Account Info menu of the CMS software ([see page 74](#)). Available for entry when the Version field is set to Ver. 3.
  - PIN Code
    - The PIN code for the CMS server. The PIN is located on the Device menu of the CMS software ([see page 79](#)). Available for entry when the Version field is set to Ver. 3.
  - Version

- The version of CMS software. The CMS application lists the software version in the lower right corner.
    - Options: Ver. 2, Ver. 3
    - Default: Ver. 2
  - Content
    - The storage location for CMS content downloaded from the server.
    - **Options:** Internal Storage, SD Card, USB Storage
    - **Default:** Internal Storage
- PDF Player
  - Enters the PDF Player configuration menu.
- External Storage
  - Enable or disable access to the SD card slot or USB connections for storage.
  - **Options:** Unlocked (unchecked), Locked (checked)
  - **Default:** Unlocked (unchecked)

## System Tools



- Clear Storage
  - Erase all user configurable storage in the selected location
    - All: Internal storage, USB storage and SD card
    - Internal Storage
    - USB Storage
    - SD Card
- Factory Reset



- Reset all internal storage to default values
- **Note:** Choosing this option will cause the display to go through initial setup ([see page 28](#)).
- Export Signage Display Settings
  - Write all display settings to a USB storage device or an SD card, excluding the Signage Display Name field.
  - This allows the display's settings to copy to another unit.
- Import Signage Display Settings
  - Read all display settings from a USB storage device or an SD card, excluding the Signage Display Name field.
  - This allows the display's settings to copy from another unit.
- Clone Media Files
  - This menu allows all media files to copy from the specified location to the selected destination.



- Clone Source
  - The source location to copy the media files from
  - Options: Internal Storage, SD Card, USB Storage
- Target Location
  - The destination location to copy the media files to
  - Options: Internal Storage, SD Card, USB Storage
- Clone
  - Press to complete the clone operation

## Display

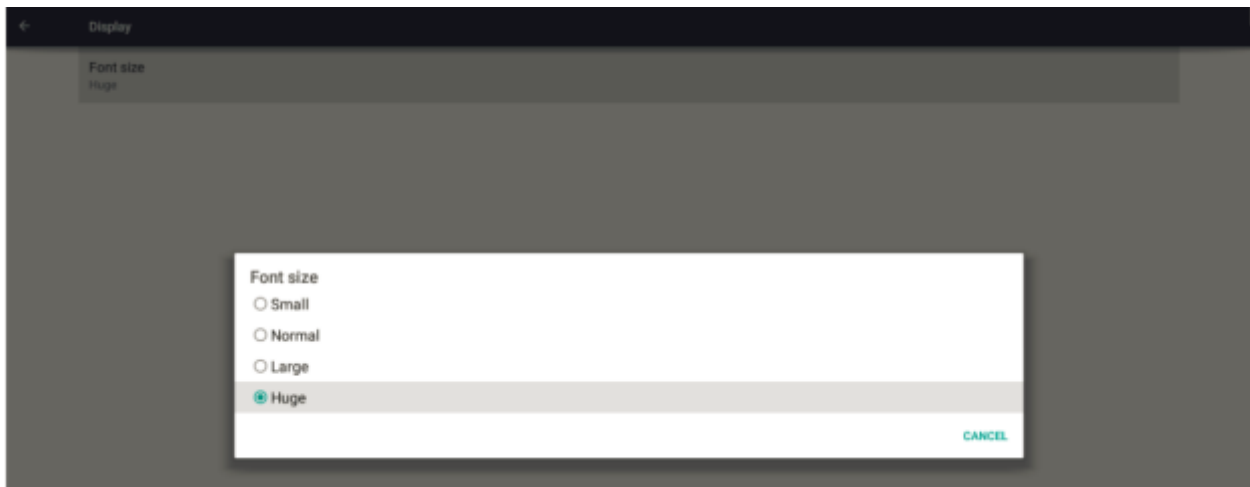

- Font Size
  - Configures the font size used in the Android menu
  - **Options:** Small, Normal, Large, Huge
  - **Default:** Huge

## Apps

- Provides a list of any additional apps installed on the display

- **Note:** Loading additional or custom apps is not supported.

## Date & Time



- Select Time Zone
  - Set the current time zone
- NTP Server
  - Lists the Network Time Protocol (NTP) used to automatically obtain the current date and time.

## Developer Options

- Android debugging controls for engineering use only.

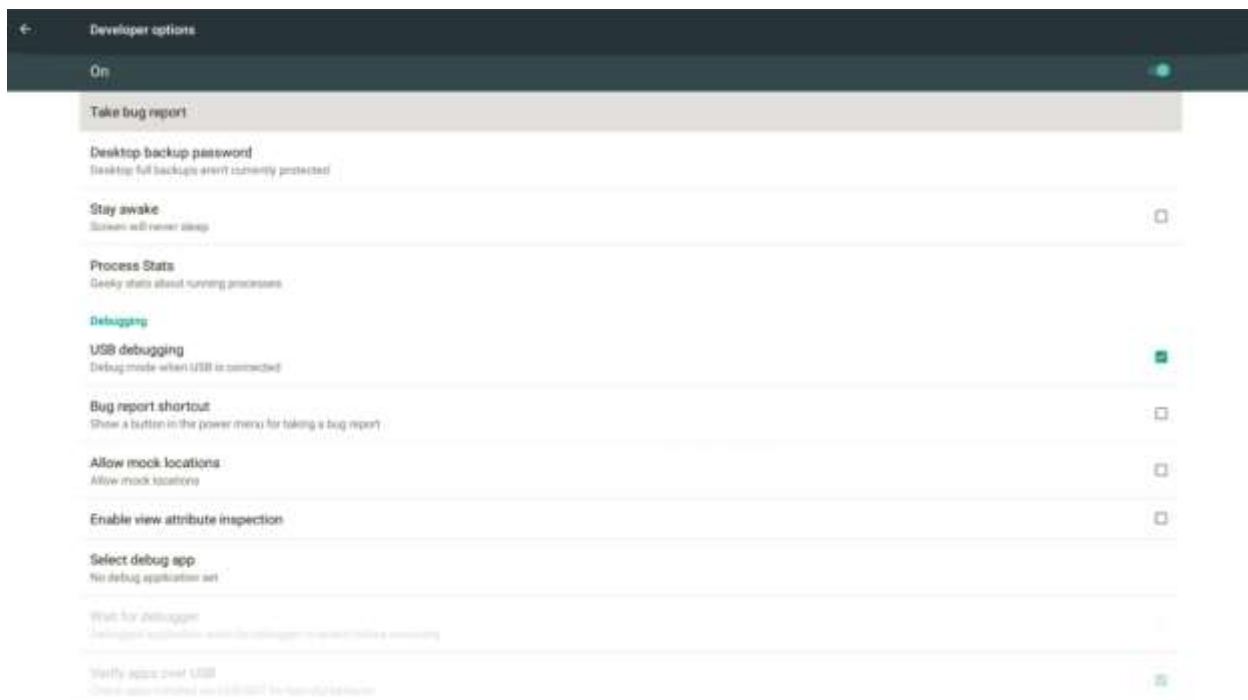

## About

- Lists firmware version information and initiates the firmware upgrade process. Refer to the directions in the firmware upgrade package for more information.



## 20.3 Apps

Lists pre-installed apps on the display. Select an app to run it.

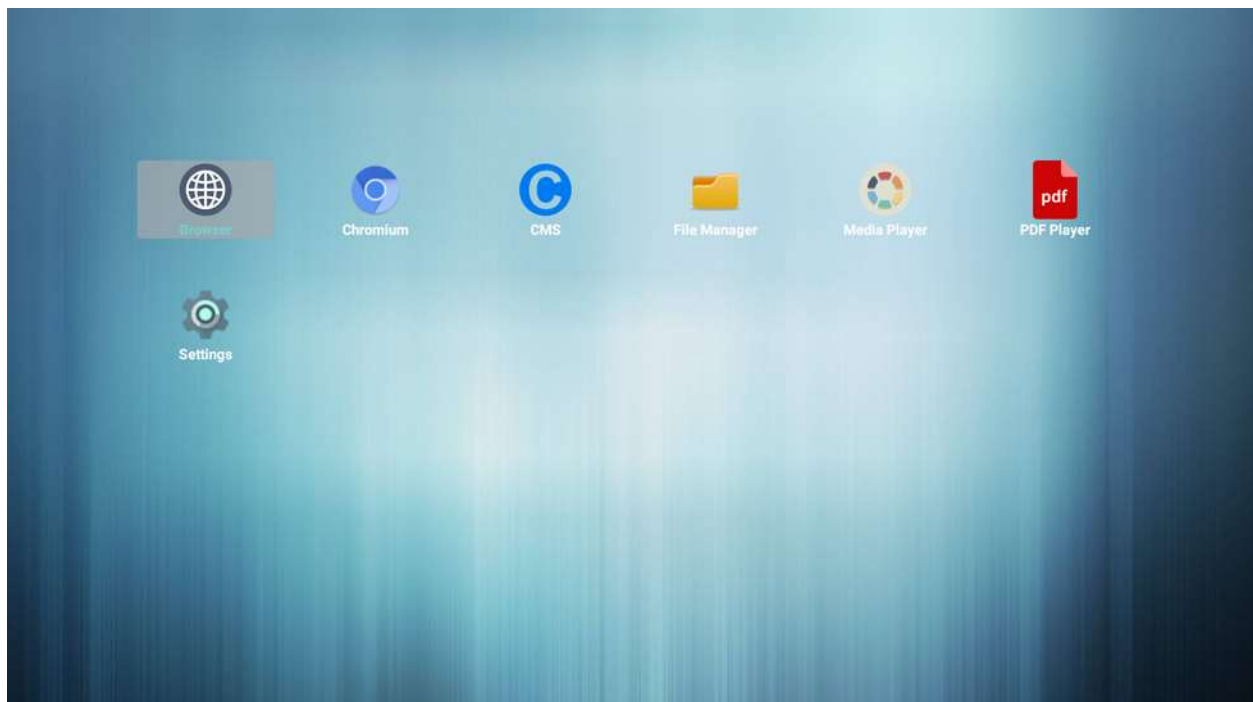

## 20.4 Network

Click Ok to navigate through to Ethernet menu.

See the Ethernet menu under Settings on [page 51](#).



## 20.5 Storage

Allows management of the internal file system and any drives connected via USB.



## 21. Media Player

The Planar Simplicity Series 4K display has an embedded Media Player that can be used to play videos, photos and/or music from a USB Drive. Please see below for more information.

### 21.1 Supported Media Formats

The table below outline the supported media formats and compatibility for video, audio, and visual content.

Media Player Video Compatibility		
Format	File Types	Max Resolution and Bit Rate
MPEG 1/2	MPEG program stream (.dat, .vob, .mpg, .mpeg) MPEG transport stream (.ts, .trp, .tp) MP4 (.mp4, .mov) 3GPP (.3gpp, .3gp) AVI (.avi) MKV (.mkv)	1080p/60Hz 40Mbps
MPEG 4	MP4 (.mp4, .mov) 3GPP (.3gpp, .3gp) AVI (.avi) MKV (.mkv)	1080p/60Hz 40Mbps
H.263	FLV (.flv) AVI (.avi)	1080p/60Hz 40Mbps

Media Player Video Compatibility		
Format	File Types	Max Resolution and Bit Rate
H.264	FLV (.flv) MP4 (.mp4, .mov) 3GPP (.3gpp, .3gp) MPEG transport stream (.ts, .trp, .tp) ASF (.asf) WMV (.wmv) AVI (.avi) MKV (.mkv)	1080p/60Hz or 4K/30Hz 135Mbps
H.265	MP4 (.mp4, .mov) 3GPP (.3gpp, .3gp) MPEG transport stream (.ts, .trp, .tp) MKV (.mkv)	4K/60Hz 100Mbps
Google VP8	MKV (.mkv) WebM (.webm)	1080p/30Hz 20Mbps
Motion JPEG	AVI (.avi) 3GPP (.3gpp, .3gp) MP4 (.mp4, .mov) MKV (.mkv)	1080p/30Hz 40Mbps

Media Player Audio Compatibility		
Format	File Types	Max Bit Rate and Sampling Rate
MPEG Audio (MPEG 1/2/2.5 Audio Layer 1/2/3)	MP3	8-320 Kbps 16-48 KHz 2 Channel
Windows Media Audio (WMA Version 7, 8, 9, 10 Pro M0, 10 Pro M1, 10 Pro M2)	WMA	8-768 Kbps 8-96 KHz 2 Channel
AAC Audio (MAIN, ADIF, ATDS Header, AAC-LC, AAC- HE)	AAC M4A	Bit Rate: N/A 8-48 KHz 5.1 Channel

Media Player Image Compatibility		
Format	File Types	Max Resolution
JPEG (JFIF file format 1.2)	JPG JPEG	7000 x 7000
BMP	BMP	15360 x 8640
PNG	PNG	15360 x 8640

## 21.2 Main Menu

### Play

- This menu starts showing the content in a created playlist. If no playlists are available, create one starting with the Compose section on [page 65](#).
- The content will play in the order selected during content creation, and with the features selected in the Settings menu.





## Compose

- Use this menu to create a playlist of photos and/or videos.
- Select media from
  - Internal
  - USB
  - SD card
- Photos must be in the following folder: /planar/photo
- Videos must be in the following folder: /planar/video
- Audio files must be in the following folder: /planar/music



- Press the Options key on the remote to bring up the sidebar menu

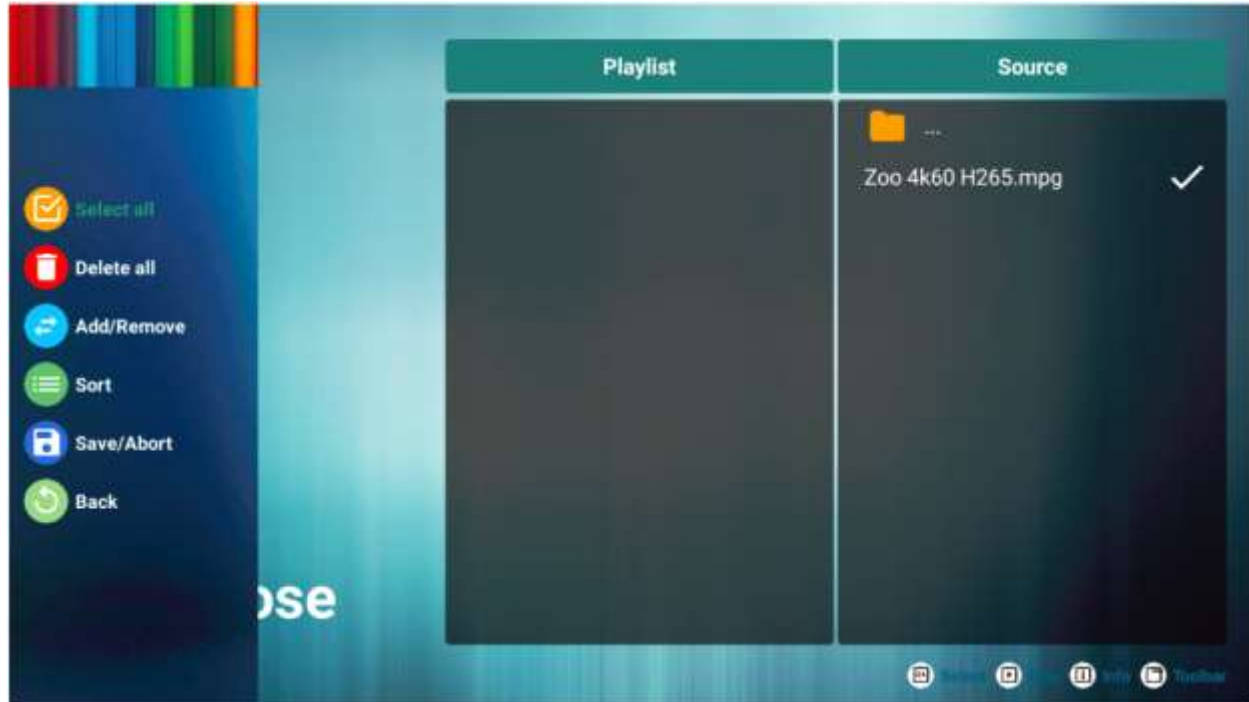

- Delete All: Remove all items from the current playlist
- Add / Remove: Add or keep checked items in the playlist.
- Remove unchecked items from the playlist if present.
- Sort: Rearrange the order of files in the playlist
- Save / Abort: Save or discard the changes to the playlist
  - **Note:** Save changes to the playlist once, modifications are complete. Any unsaved changes will be lost.
- After saving the playlist, background music can be added.
  - **Note:** This option is displayed after saving a playlist (see image below).
- Back: Close the sidebar menu

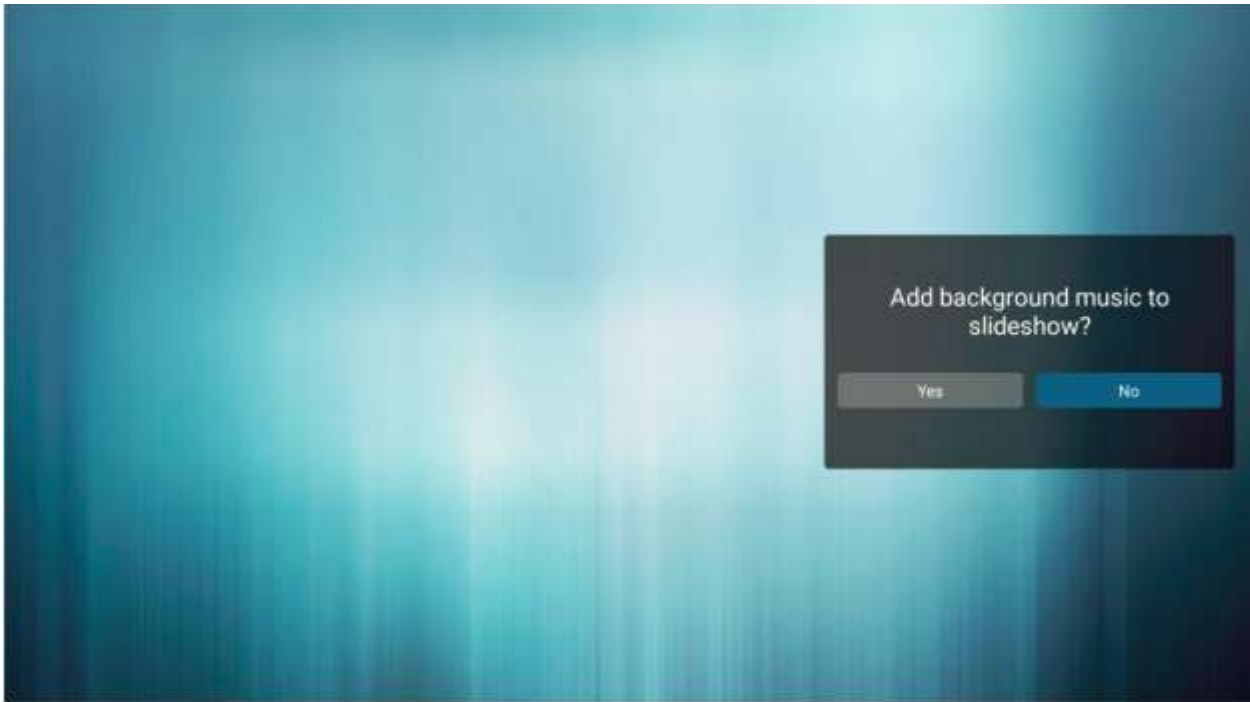

## Settings

- This menu contains several options for customizing your playback experience

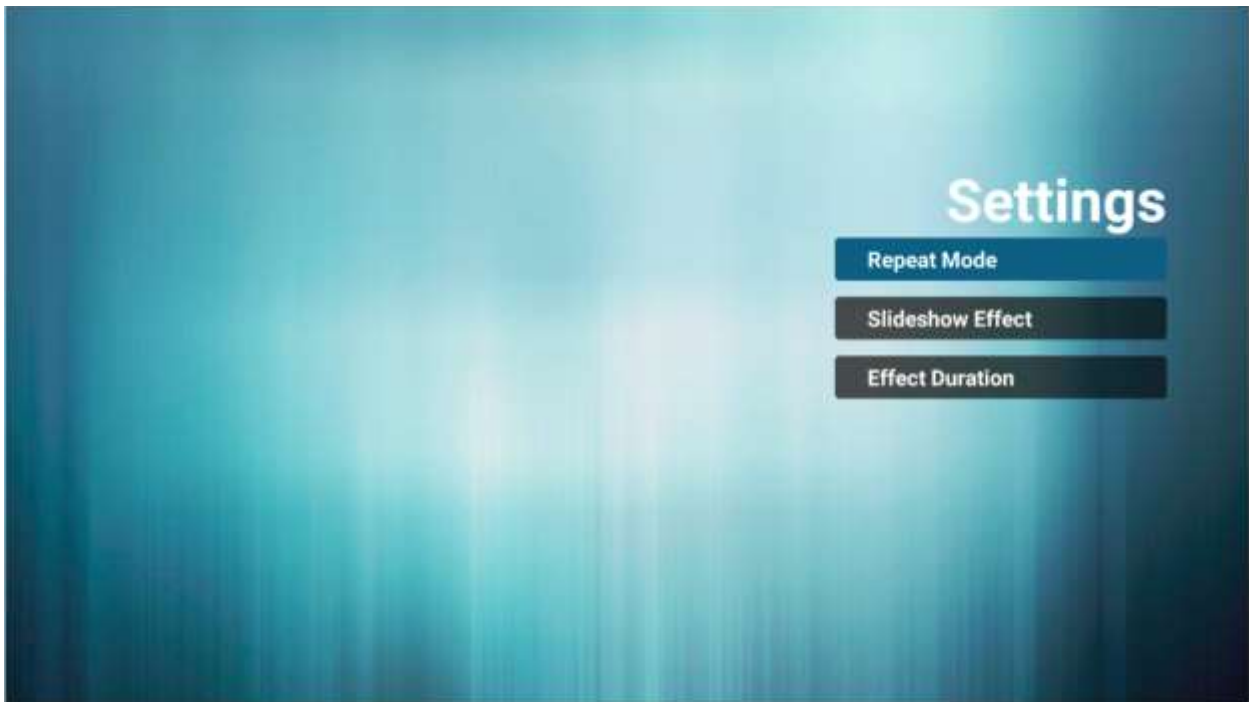

- Repeat Mode
  - Play each file only one time or repeat them
  - **Options:** Repeat Once (display each file once), Repeat All (repeat showing all files)
  - **Default:** Repeat All
- Slideshow Effect
  - Select the transition type that occurs when switching from one image to another
  - **Options:** Random, Bounce, Fade In/Out, Top to Bottom, Zoom, Left to Right, Right to Left, Fold, Corner, None
  - **Default:** None
- Effect Duration
  - Select the amount of time to show each image in the playlist
  - **Options:** 5 sec, 10 sec, 15 sec, 20 sec
  - **Default:** 5 sec

## 22. Browser Menu

The Planar Simplicity Series 4K display has an embedded browser that can be used to schedule and deploy simple, web-based content. Please see below for more information.

### 22.1 Settings

This menu offers seven input fields for URL configuration using manual entry and import and export list functions.



- Click Settings and choose any list item (1-7) then enter a URL. Press Ok to save data on the list. See figure below for reference.



#### Option

- This sidebar menu accesses import and export functions for the URL list.
- To access the menu, scroll past the last URL entry and click Option.



- Import
  - Import URLs from a text file from one of the following sources:
    - Internal
    - USB
    - SD card
  - Click Import and choose storage location, select file, and press Import to add URLs in to the URL list.
  - **Note:** The file containing URLs must be formatted as a text file, and an internal file is only available as a source if a file is uploaded directly to the display using the FTP server function ([see page 54](#)).

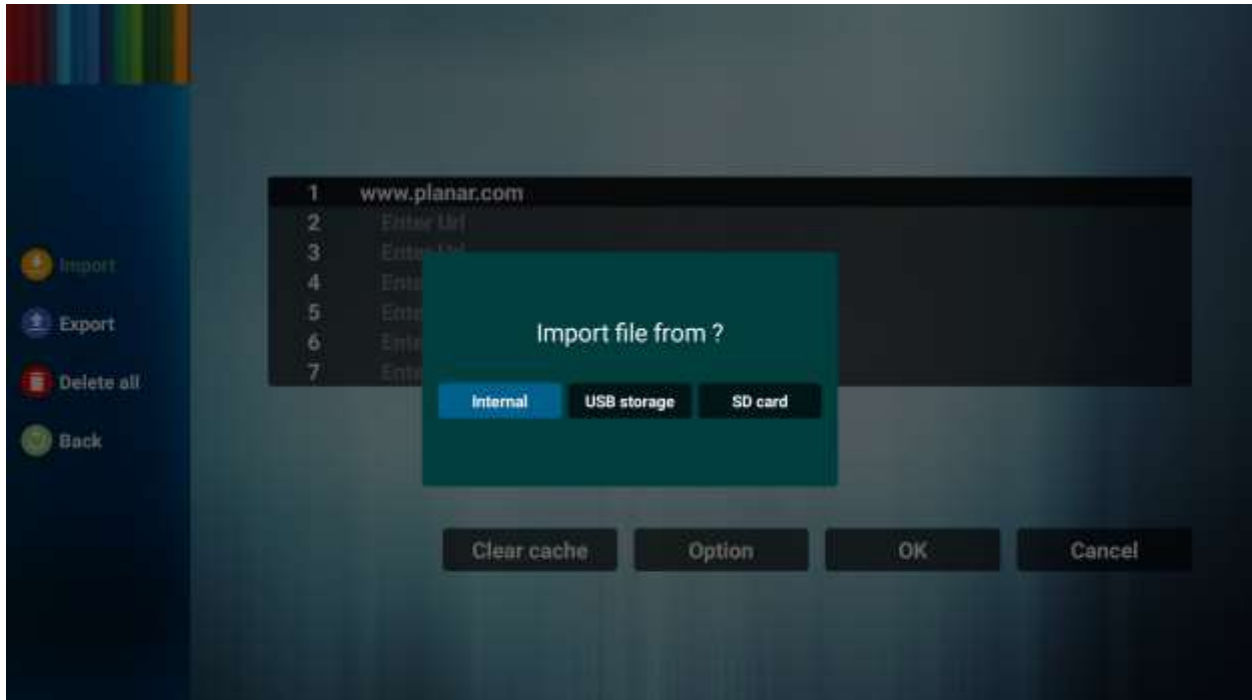

- Export
  - Export the URL list to a file on one of the following sources:
    - Internal
    - USB
    - SD card
  - Choosing internal storage opens a dialogue box showing the file path and file name. Saving the list to the internal location specified in the storage path makes the list available as future internal import option
  - Press save and Ok to navigate back to the main menu.
  - **Note:** If you do not click Ok then changes made to the list will not save.

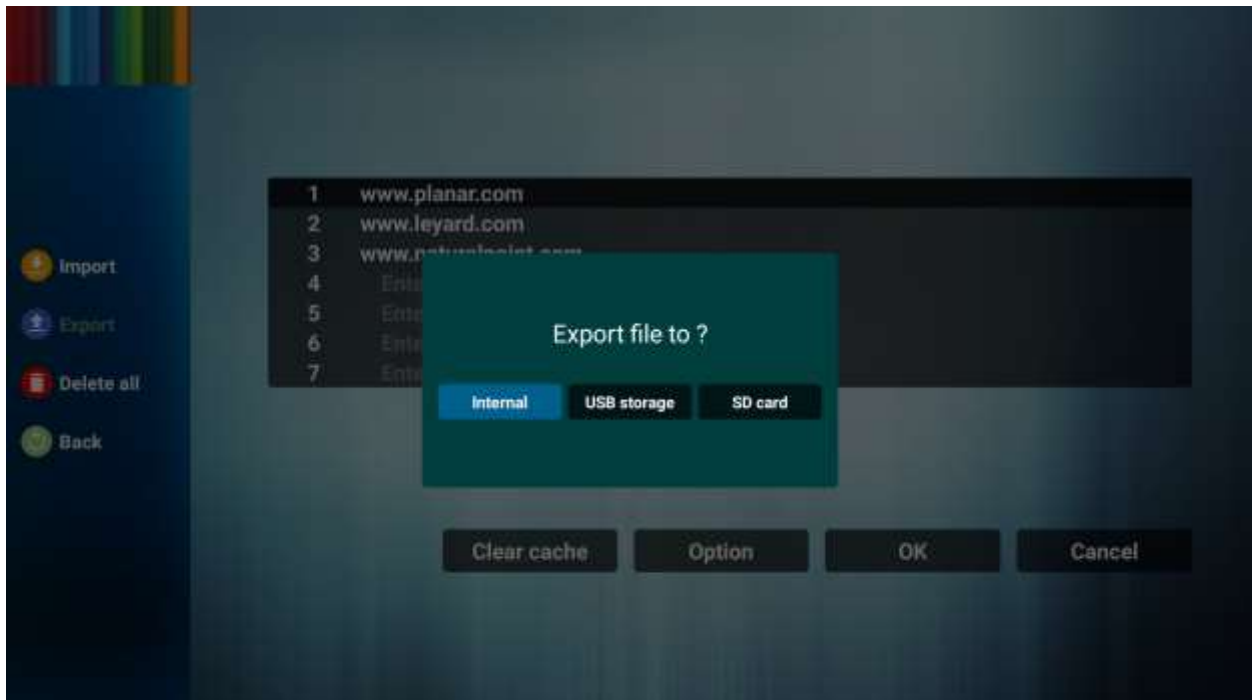

- Delete all
  - Deletes all URL records from the URL list page
- Back
  - Closes sidebar option menu
- Once URL list options are saved, you can choose to Edit or Play a URL
  - Edit: Edit existing URL dialog
  - Play: Navigates to and opens the webpage stated by the URL

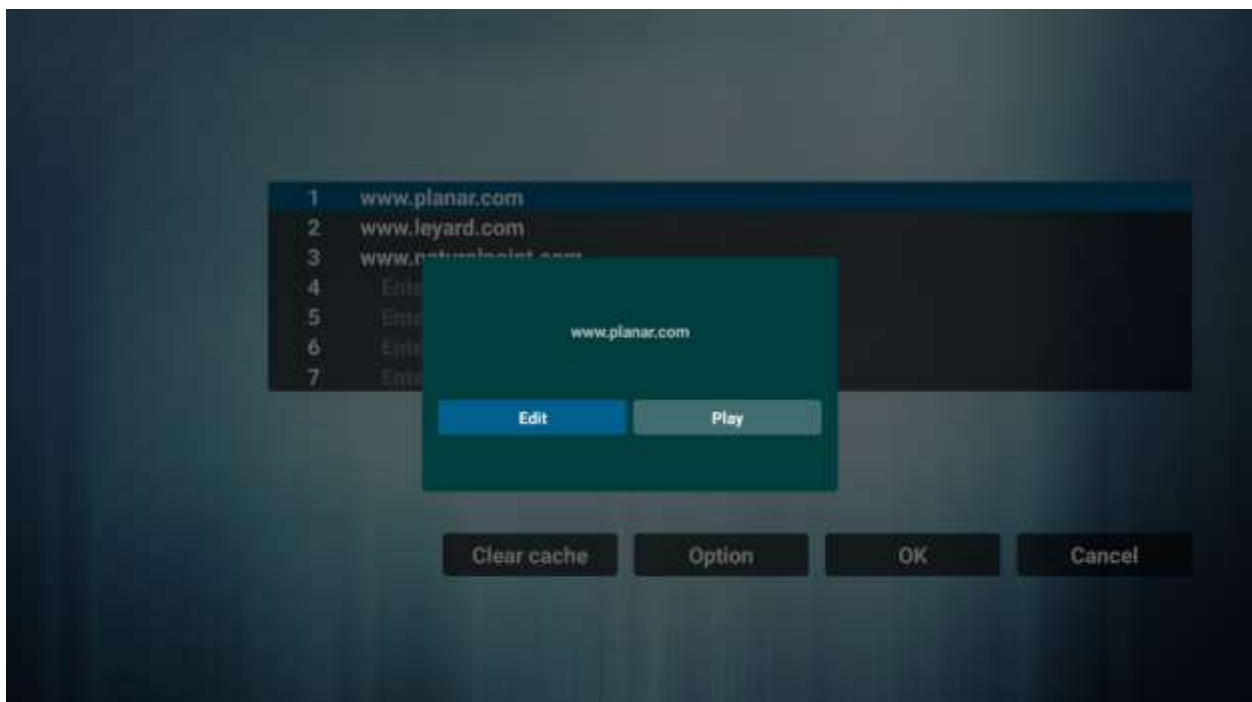



## 22.2 Boot on Source Functionality

Browser is one of the OSD Menu Boot On Source options ([see page 43](#)).

- To configure this setting go to the OSD Menu, select Configuration 1, and set input to Browser.
- Choose a numbered URL option from the URL list and press Save.
  - **Note:** The Default Browser in the Boot on Source Menu is 0. If you do not assign a URL list number, the display will restart showing the Browser Settings Menu. The picture below is from OSD menu for reference.

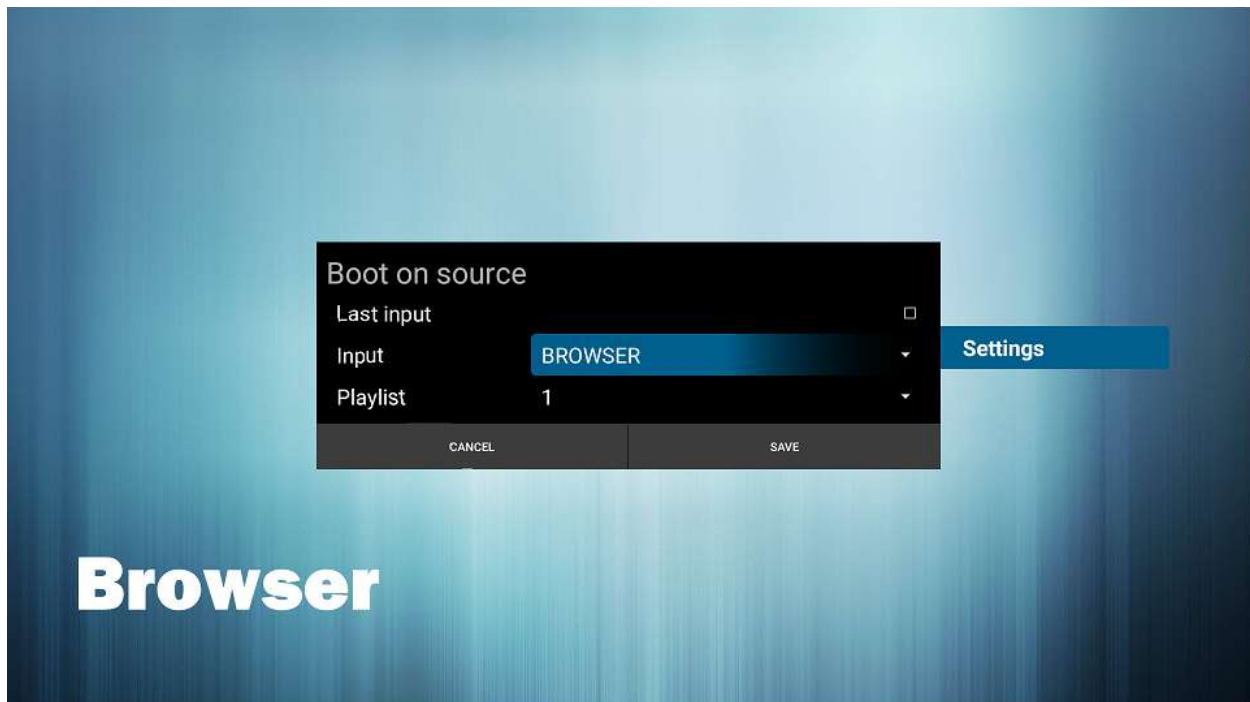

## 23. Content Management System

The Planar Simplicity Series 4K display has an integrated Content Management System (CMS), enabling the user to download software directly onto their PC and use other assets such as photos or videos, to create digital signage content and then schedule and deploy to the display. Please see below for more information.

**System Requirements:** Windows 7/8/10

### 23.1 Initial Setup

1. Download the CMS software from the Planar website under the Support Drivers and Software section ([see page 92](#)).  
**Note:** CMS must be used with a PC and accompanying Windows software.
2. Launch CMS and use the default administrator credentials to login for the first time. See Login below.
3. Change the account name and password by going to Account Info in the Account dropdown ([see page 74](#)).
4. Go to the Settings section of the Android menu on your display ([see page 51](#)). Scroll down and select Signage Display, then select CMS.
5. Enter the following credentials
  - a. Version: Ver. 3
  - b. Server: IP address of the computer controlling the CMS software
  - c. Account: Enter Account Info name set during step 3.
  - d. PIN Code: Code is located in the top right corner of the purple box in the CMS Device List Menu ([see page 79](#)).
6. After CMS is setup in the Android menu ([see also page 55](#)), return to the CMS software to configure content and scheduling for deployment on the display. See details below.

### 23.2 Login

To Login, The default administrator credentials are as follows:

- Account: admin
- Password: admin

The administrator can create new accounts, which will use the following default password:  
Ab123456



## 23.3 Main Menu

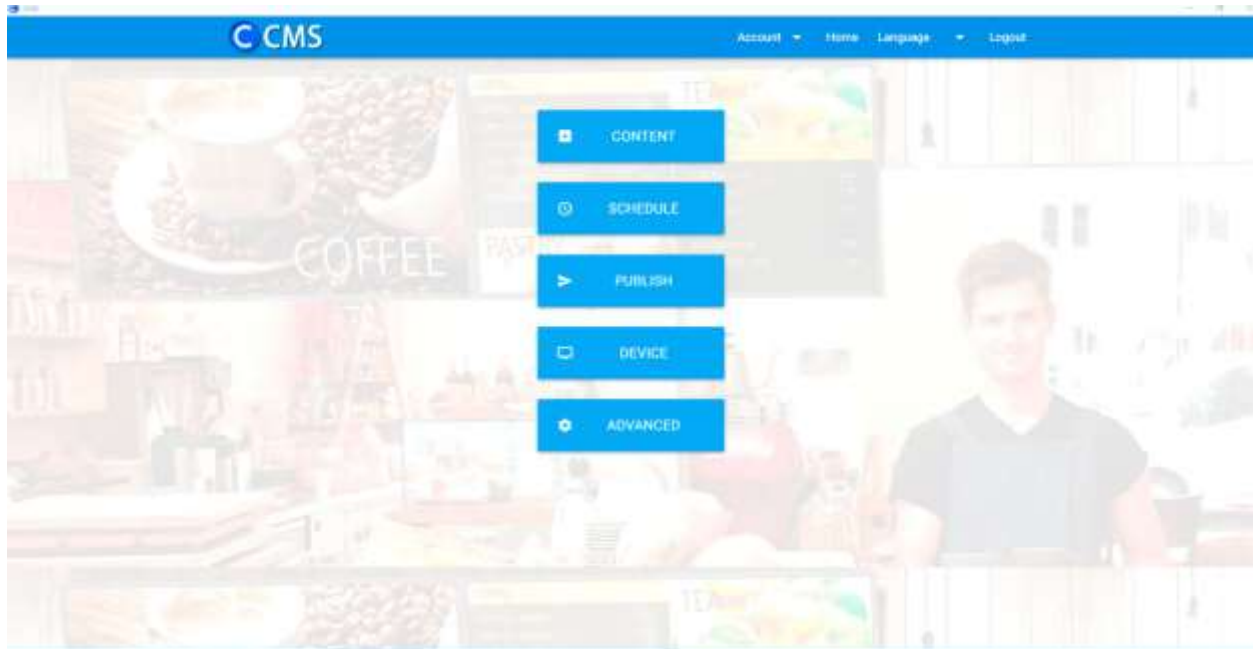

### Account

- Account MGMT

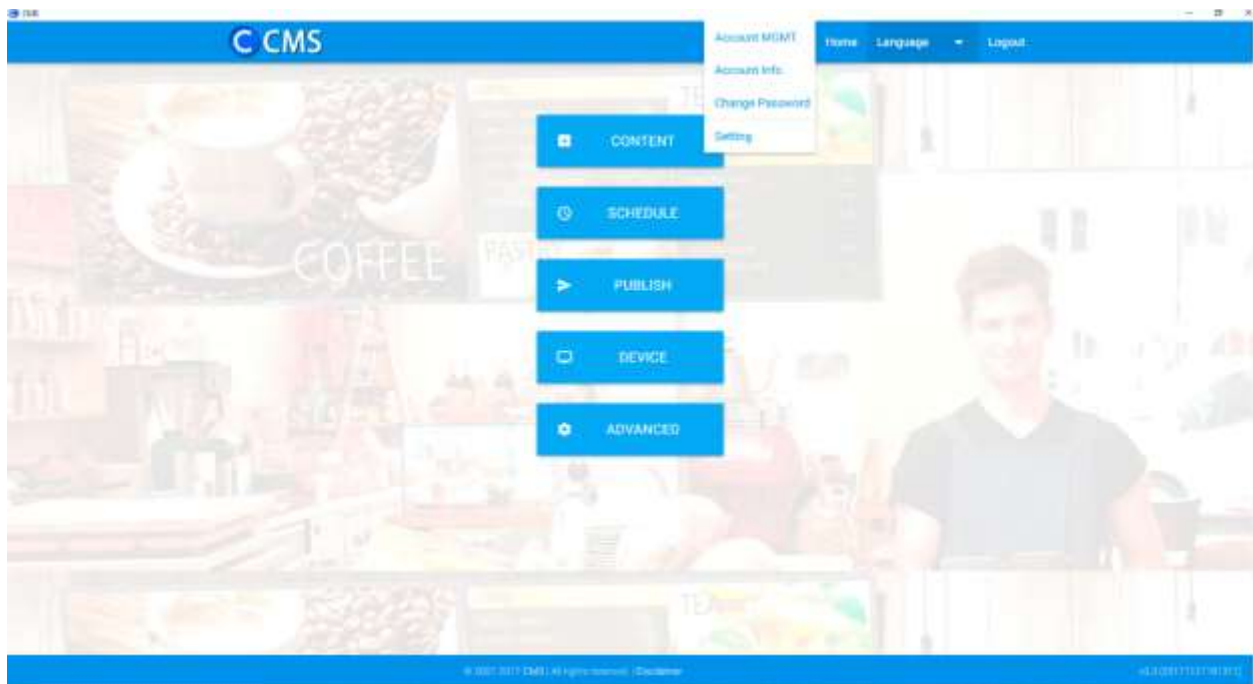

- Create additional regular user accounts that have access similar to an administrator, but with the following exceptions:
  - Cannot create additional accounts
  - No backup/restore functionality
- Account Info
  - Select the nickname for your account

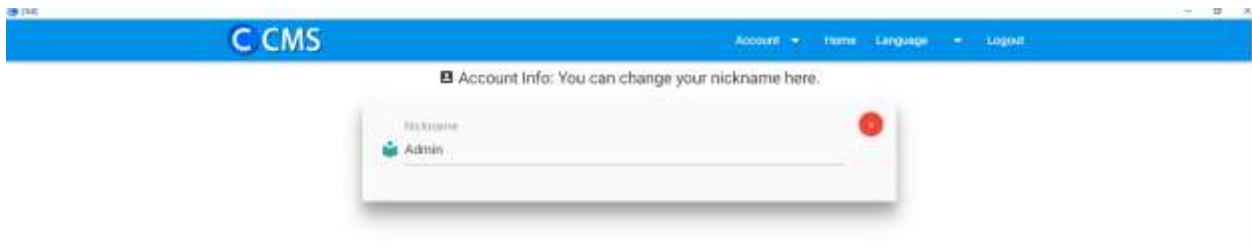

- Change Password
  - Change the password for your account

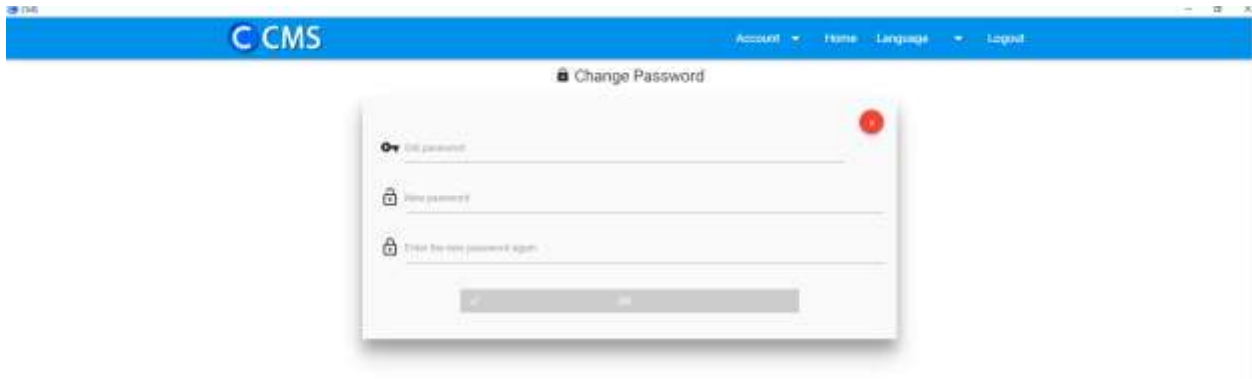

- Setting
  - Configure the behavior and appearance of the application

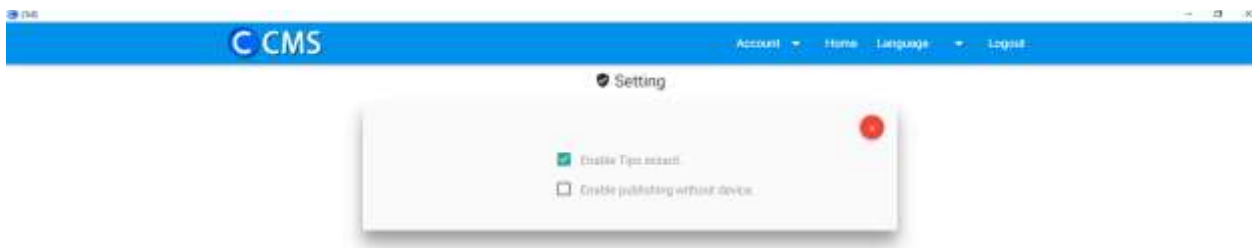

## Home

- Return to the main menu

## Language

- Select the language to be used in the CMS software
  - **Options:** English, Simplified Chinese, Traditional Chinese, Japanese
  - **Default:** English

## Logout

- Logout of the CMS software and return to the login screen

## Content

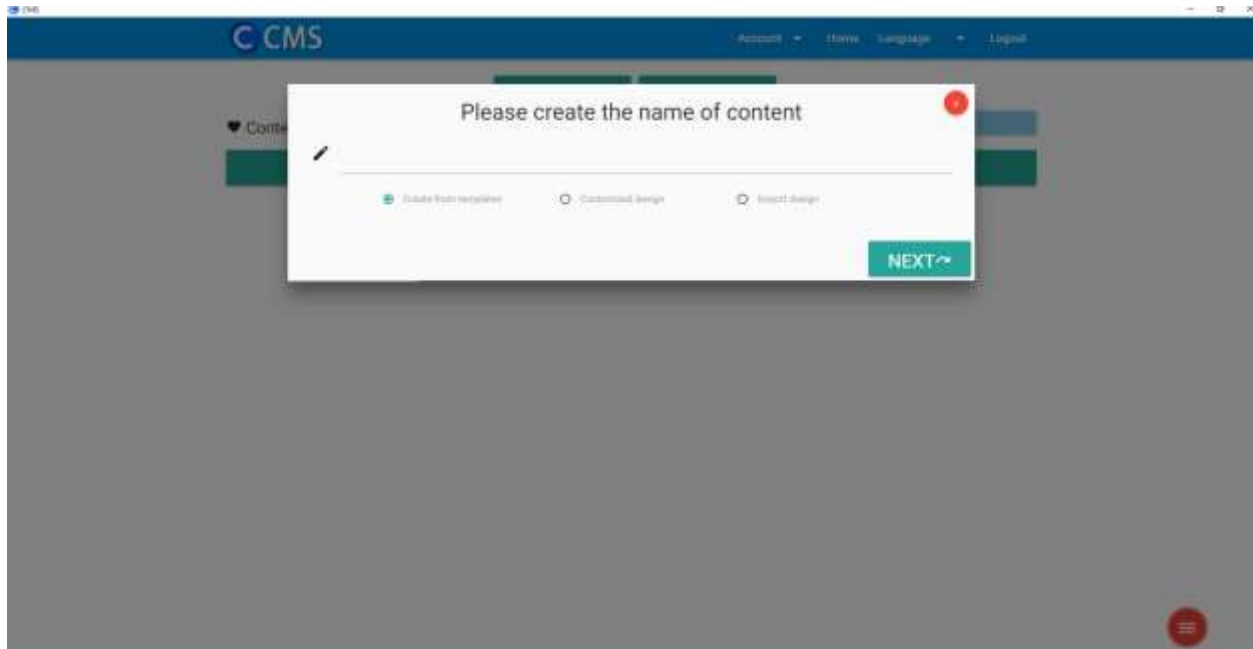

- Create content for your display
  - Press the Create Content button to get started
  - Add a name for your content
  - Choose one of the options for content creation:
    - Create from templates

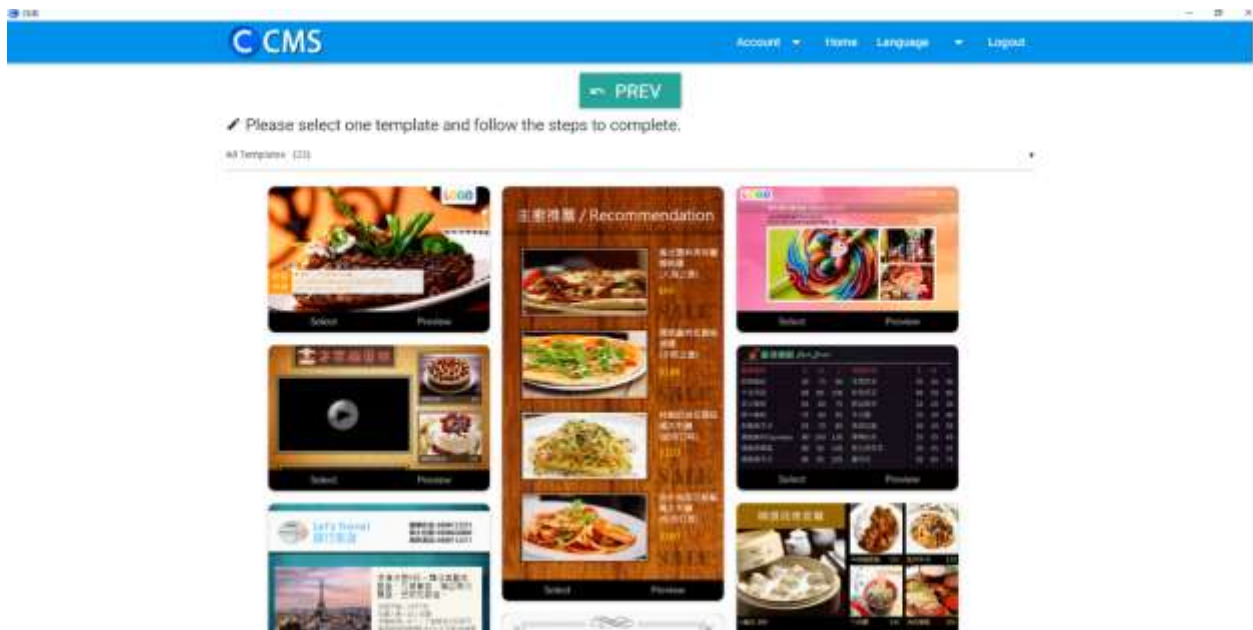

- Several predefined layouts are available to select.
- For each layout, select an image and/or text to display in each section of the layout, as shown in the top middle of the page.
- Press Next to add an image and/or text for the next section of the layout. When complete, press Done.
  - Customized design

- Import design
- After completing the content, select whether to schedule the content, create more content, or go to the main menu.

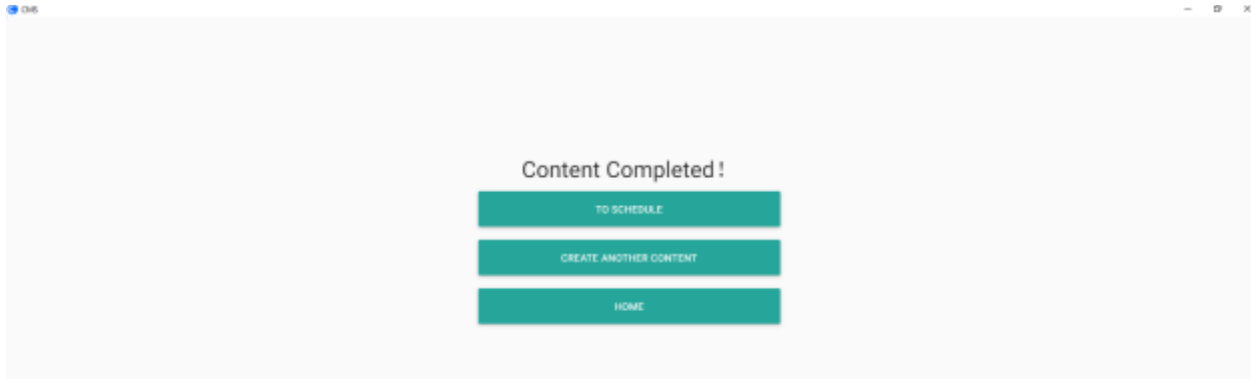

## Schedule



- Configure timing for content to play during the day
- Select a group schedule to modify and press Next.
- If there are no groups present, you will need to setup your devices in the Device menu before proceeding ([see page 79](#)).
- Create one or multiple time slots.
  - To add a time slot, press Create Time Slot and enter a name.
  - To edit a time slot, click the time slot and press Next.



- Select any of the available one-hour intervals for this time slot.
  - Unavailable intervals are being used by another time slot.
  - Press Next when finished

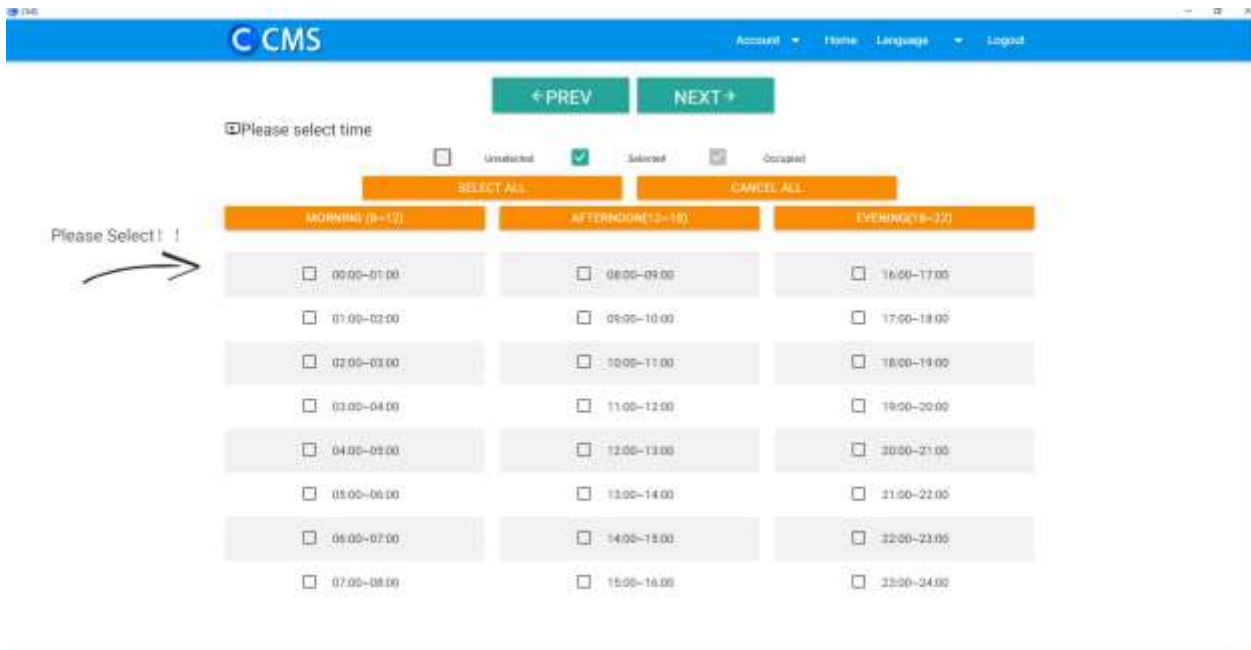

- Select content to play during this time slot.
  - Select one or more of the available content options then set playtime using minute and second intervals.
  - Press Done when finished.



- After creating your time slot, you can choose to proceed by publishing, creating another time slot, or returning to the main menu.

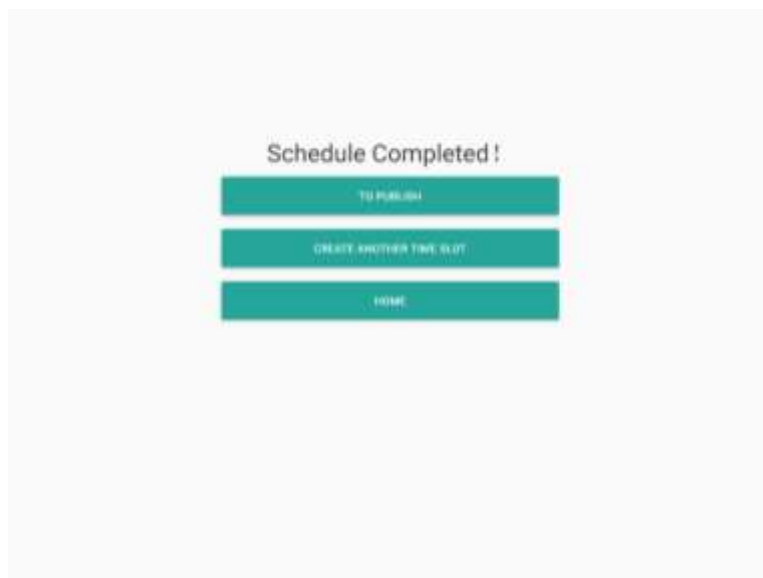

## Publish



- Send content to a group of displays.
- To schedule publishing on a future date, press Scheduled Publishing and select the publishing date. Otherwise, content will publish immediately.
- Press Publish History to see a list of all previously published content.
- Click on a group to begin publication.
  - To choose a default layout to use when no specific content is scheduled for publication, click the drop-down list under Default Layout.
  - **Note:** The current date and time can be displayed instead of content.
- When ready to publish the selected group, click Publish Now

## Device

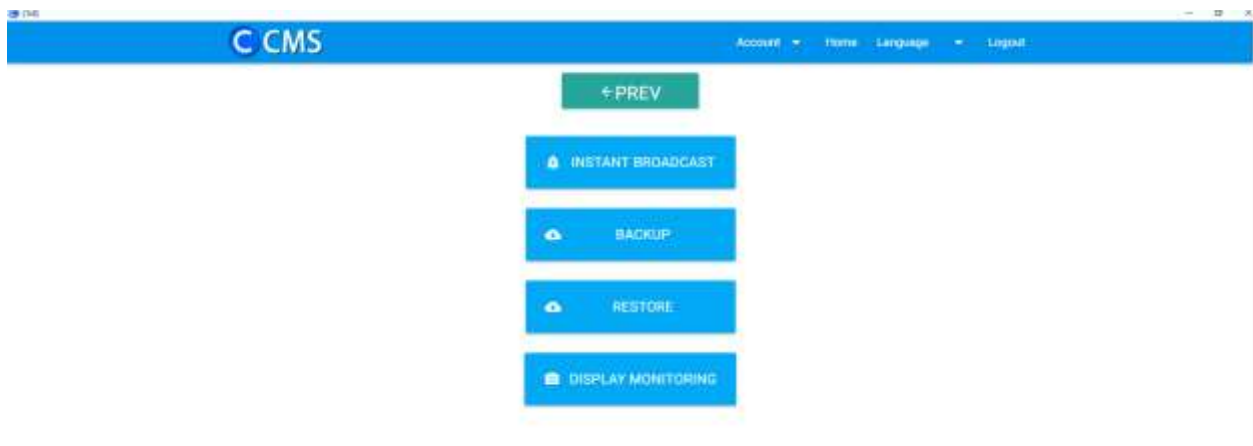

- Lists all displays on the network with CMS functionality. If a display is missing, confirm the Account and PIN Code values are entered in the display CMS setup ([see page 73](#)).
  - PIN Code is indicated in the top right corner of the Device List Menu

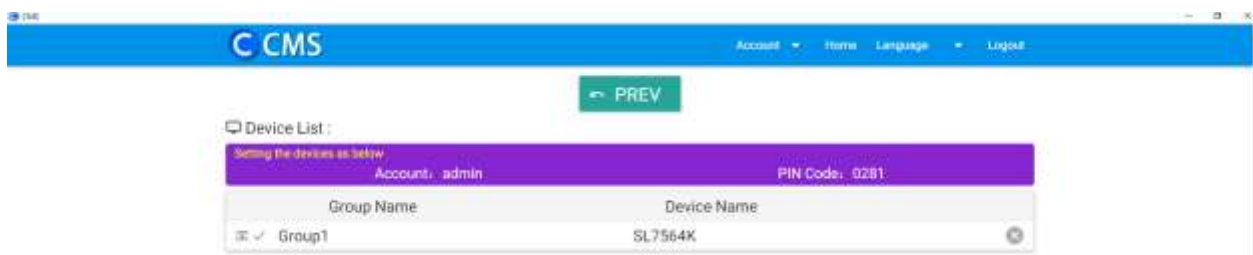

- Click on a display to edit the device name or group selection.



Advanced

- Instant Broadcast
  - Immediately display the selected warning, emergency, or custom content. Only valid if CMS content is currently playing on the display.

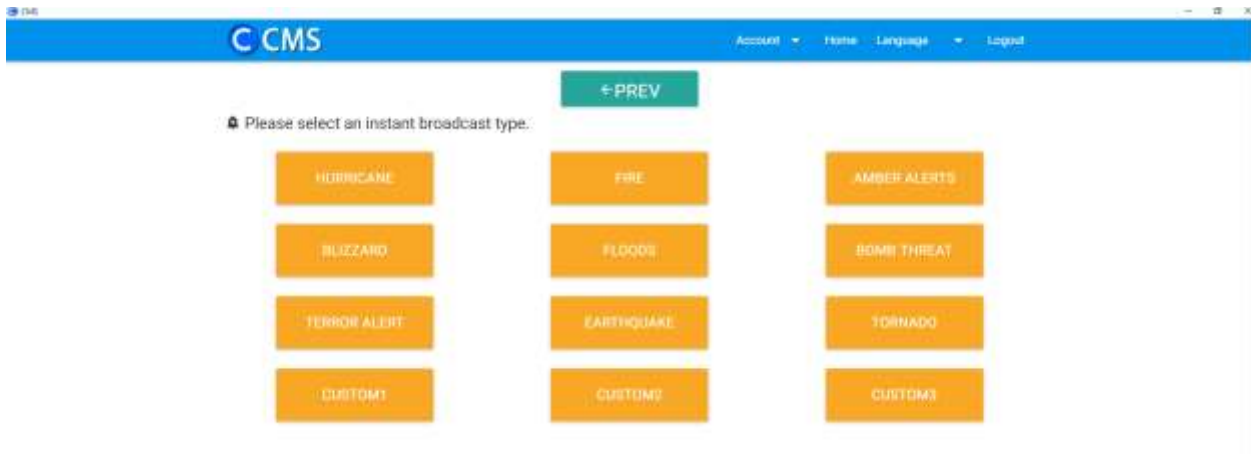

- Backup
  - Save all of the content on the CMS server to a backup file. Only available on the admin account
- Restore
  - Reload all of the content from a backup file onto the CMS server. Only available on the admin account.
- Display Monitoring
  - Show the CMS image currently visible on the display



# External Control

In addition to using the Planar Simplicity 4K Series remote control and display, there are other methods of controlling the Planar Simplicity Series display externally:

- Using a serial link to send binary commands and to receive responses to those commands. The same set of commands can be sent over RS-232, USB, TCP or UDP. See the *Planar Simplicity Series 4K RS232 User Manual* for more information.
- Using discrete infrared (IR) codes to program a third-party remote control.

# Signal Compatibility

Compatible Video Sources									
Signal Type	Resolution	Frame Rate (Hz)	Line Rate (kHz)	Pixel Rate (MHz)	HDMI 1-4	DVI	DP + OPS	VGA	References
PC	640x350	70.090	31.469	25.175	x	x	x	x	
	640x480	59.940	31.469	25.175	x	x	x	x	VESA DMT, CEA-861-F Format 1
	640x480	72.809	37.861	31.500	x	x	x	x	VESA DMT
	640x480	75.000	37.500	31.500	x	x	x	x	VESA DMT
	720x400	70.087	31.469	28.322	x	x	x	x	
	800x600	56.250	35.156	36.000	x	x	x	x	
	800x600	60.317	37.879	40.000	x	x	x	x	VESA DMT
	800x600	72.188	48.077	50.000	x	x	x	x	VESA DMT
	800x600	75.000	46.875	49.500	x	x	x	x	VESA DMT
	832x624	74.551	49.726	57.284	x	x	x	x	
	1024x768	60.004	48.363	65.000	x	x	x	x	VESA DMT
	1024x768	70.069	56.476	75.000	x	x	x	x	VESA DMT
	1024x768	75.029	60.023	78.750	x	x	x	x	VESA DMT
	1280x720	59.855	44.772	74.500	x	x	x	x	VESA CVT
	1280x768	59.870	47.776	79.500	x	x	x	x	VESA CVT
	1280x768	74.893	60.289	102.250	x	x	x	x	
	1280x800	59.810	49.700	83.500	x	x	x	x	
	1280x1024	60.020	63.981	108.000	x	x	x	x	VESA DMT
	1280x1024	75.025	79.976	135.000	x	x	x	x	VESA DMT
	1440x900	59.887	55.935	106.500	x	x	x	x	
1680x1050	59.954	65.290	146.250	x	x	x	x	VESA CVT	
1920x1080	59.934	66.587	138.500	x		x		VESA CVT-R	
SDTV	480i	60			x	x			SMPTE 125M, CEA-861-F Formats 6 & 7
	576i	50			x	x			ITU-R BT.601, CEA-861-F Formats 21 & 22
EDTV	480p	60	31.469	27.000	x	x	x	x	ITU-R BT.1358, CEA-861-F Format 17 & 18
	576p	50	31.250	27.000	x	x	x	x	SMPTE 125M, CEA-861-F Format 6 & 7
HDTV	1080i	50	28.125	74.500	x	x	x	x	SMPTE 274M, CEA-861-F Format 20
	1080i	60	33.750	74.250	x	x	x	x	SMPTE 274M, CEA-861-F Format 5
	720p	50	37.500	74.250	x	x	x	x	SMPTE 296M, CEA-861-F Format 19
	720p	60	45.000	74.250	x	x	x	x	SMPTE 296M, CEA-861-F Format 4
	1080p	50	56.250	148.500	x	x	x	x	SMPTE 274M, CEA-861-F Format 31
	1080p	60	67.500	148.500	x	x	x	x	SMPTE 274M, CEA-861-F Format 16
UHDTV	3840x2160	24	54.000	297.000	x		x		CEA-861-F Format 93, HDMI 1.4b VIC 1
	3840x2160	25	56.250	297.000	x		x		CEA-861-F Format 94, HDMI 1.4b VIC 2
	3840x2160	30	67.500	297.000	x		x		CEA-861-F Format 95, HDMI 1.4b VIC 3
	3840x2160	50	56.250	297.000	x				CEA-861-F Format 96, 4:2:0 sub-sampling
	3840x2160	50	112.500	594.000	x				CEA-861-F Format 96
	3840x2160	60	67.500	297.000	x				CEA-861-F Format 97, 4:2:0 sub-sampling
	3840x2160	60	135.000	594.000	x				CEA-861-F Format 97

# Color Subsampling Support

Video Timing	Input	RGB 4:4:4 Supported	YUV 4:4:4 Supported	YUV 4:2:2 Supported	YUV 4:2:0 Supported
4K @ 50/60Hz	HDMI 1-4	x	x	x	x
All Other Supported Timings	DVI	x			
All Other Supported Timings	HDMI 1-4, DP, OPS	x	x	x	

# Specifications

Item	SL4364K	SL5064K	SL5564K	SL6564K	SL7564K	SL8664K
<b>LCD Panel</b>						
Resolution	3840x2160					
Aspect Ratio	16:9					
Screen Size	43"	50"	55"	65"	75"	86"
Orientation	Landscape					
Brightness (Typ.)	350 cd/m <sup>2</sup>				410 cd/m <sup>2</sup>	
Contrast Ratio	5000:1	4000:1	4000:1	4000:1	1200:1	1200:1
Viewing Angle (Typ.)	176 degrees	178 degrees				
Response Time (Typ.)	8.5ms	8ms				
Color Gamut	68% NTSC				72% NTSC	
Display Color	1.07 billion (10-bit depth)					
<b>Connectivity</b>						
Standard Inputs	HDMI 2.0 x 2, DVI-D, VGA, Media Player			HDMI 2.0 x 4, DisplayPort 1.2, VGA, Media Player		
HDCP 2.2	Yes (HDMI 2.0)					
Audio Output	L/R RCA out					
Control and Monitoring	LAN RJ45, RS232 In/Out, IR In/Out, Keypad					
<b>Mechanical</b>						
Display Dimensions	38.1" x 22.0" x 2.4" (968.2mm x 559.4mm x 59.9mm)	44.2" x 25.5" x 2.7" (1123.6mm x 646.8mm x 67.9mm)	48.8" x 28.0" x 2.4" (1239.2mm x 711.6mm x 61.7mm)	57.4" x 32.9" x 3.2" (1458.7mm x 834.7mm x 81.6mm)	66.0" x 37.6" x 2.5" (1676.6mm x 955.0mm x 62.8mm)	75.9" x 43.3" x 3.0" (1927.9mm x 1098.9mm x 76.4mm)
Bezel Width	Top/Left/Right: 0.5" (11.9mm) Bottom: 0.6" (14.9mm)	Top/Left/Right: 0.5" (11.8mm) Bottom: 0.6" (14.3mm)	Top/Left/Right: 0.5" (12.9mm) Bottom: 0.6" (14.7mm)	Top/Left/Right: 0.5" (12.9mm) Bottom: 0.6" (14.9mm)	0.5" (12.5mm)	0.6" (15.2mm)
Display Weight	19 lbs (9 kg)	29 lbs (13 kg)	36 lbs (17 kg)	56 lbs (26 kg)	118 lbs (53 kg)	141 lbs (64 kg)

## Specifications

Mounting	VESA 200 mm x 200 mm VESA 400 mm x 400 mm	VESA 400 mm x 400 mm	VESA 400 mm x 200 mm VESA 400 mm x 400 mm	VESA 400 mm x 400 mm	VESA 600 mm x 400 mm	VESA 600 mm x 400 mm
Fanless	Yes					
Speakers	10W x 2 built-in					
<b>Usage</b>						
Recommended Usage	16x7					
Backlight	D-LED				E-LED	
Backlight Life	30,000 hours min					
<b>Power Source</b>						
Power Consumption (Typ.)	95W	125W	130W	150W	215W	275W
BTU/hr (Typ.)	95W x 3.42 BTU = 325 BTU/hr	125W x 3.42 BTU = 428 BTU/hr	130W x 3.42 BTU = 445 BTU/hr	150W x 3.42 BTU = 513 BTU/hr	215W x 3.42 BTU = 735 BTU/hr	275W x 3.42 BTU = 941 BTU/hr
Standby Power Consumption	< 0.5W					
Input Voltage / Frequency	AC 100-240V 50-60 Hz					
OPS Power	N/A			16V / 4A		
<b>Environment</b>						
Storage Temperature	Min -4°F ~ Max 140°F (-20°C ~ 60°C)					
Operating Temperature	Min 32°F ~ Max 104°F (0-40°C) at up to 3000 m					
Humidity	20-85% RH					
Approvals	FCC Class A, cTUVus, CE	FCC Class A, UL, CE				

# Dimensions

## SL4364K

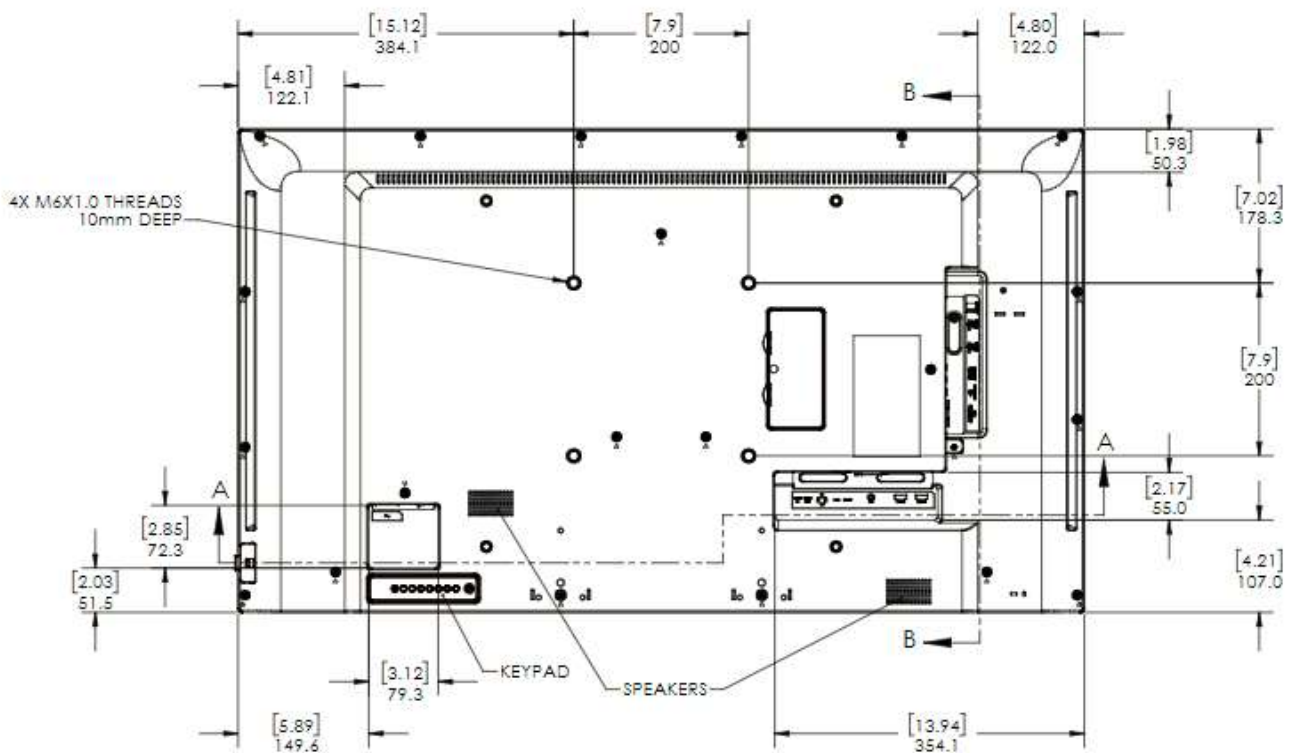
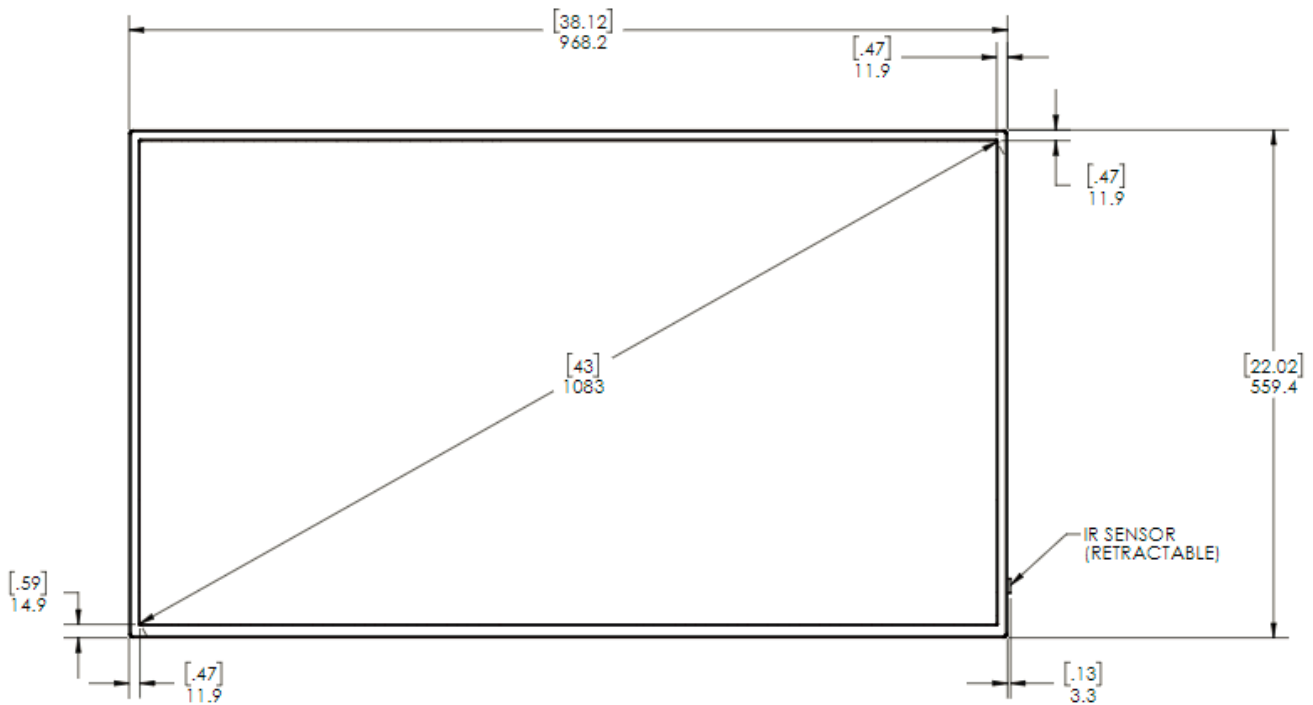

# SL5064K

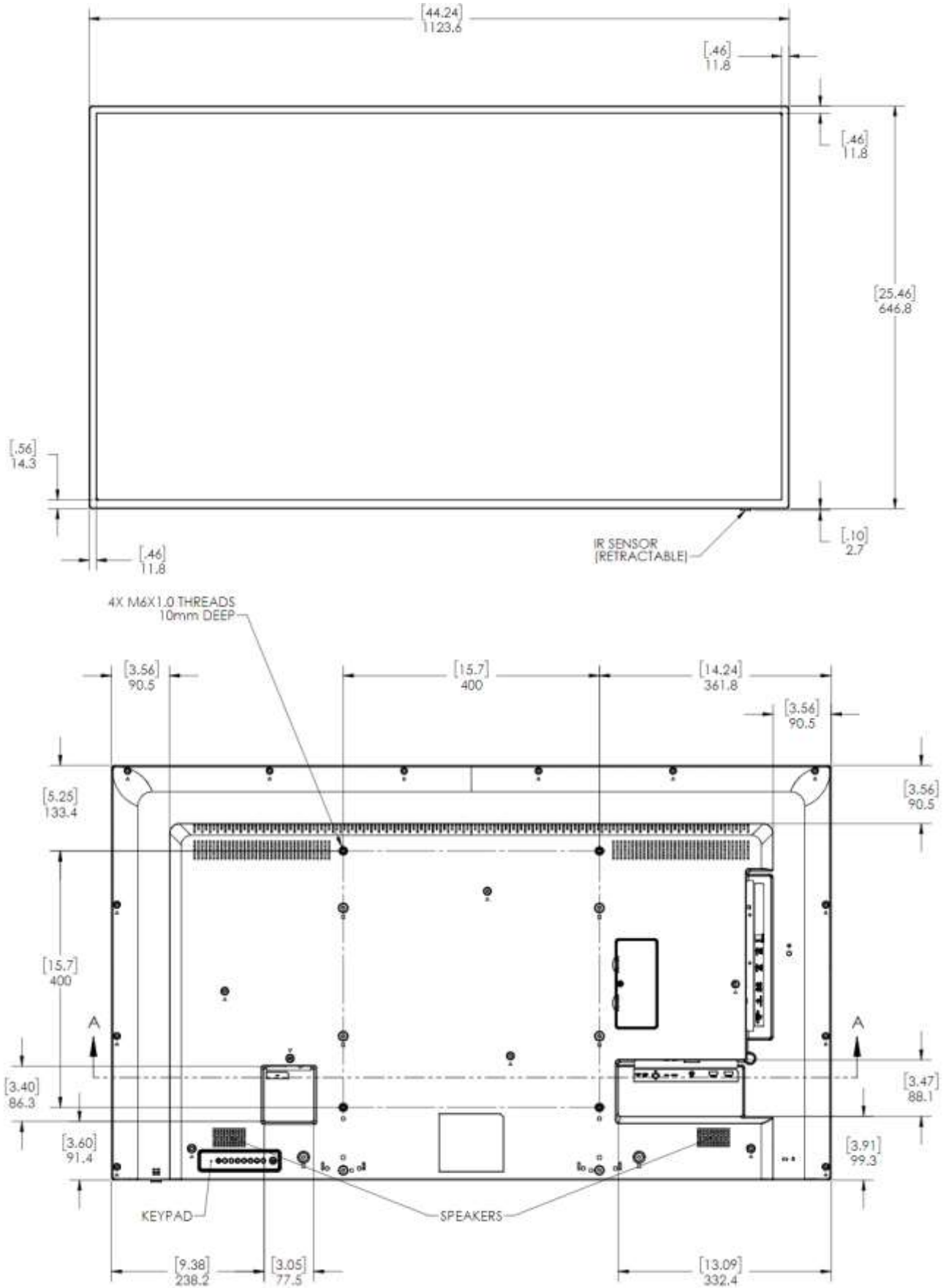



# SL5564K

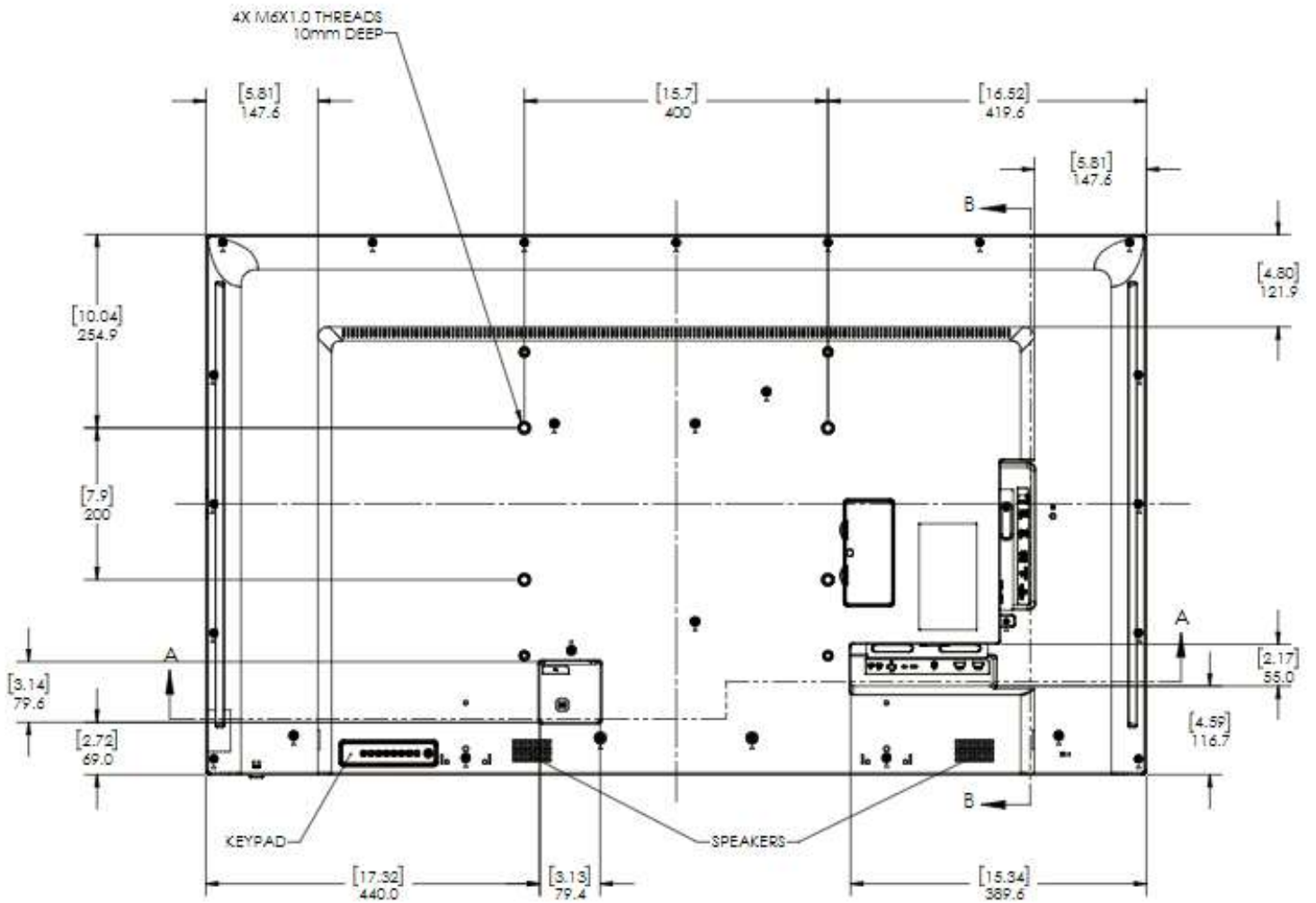
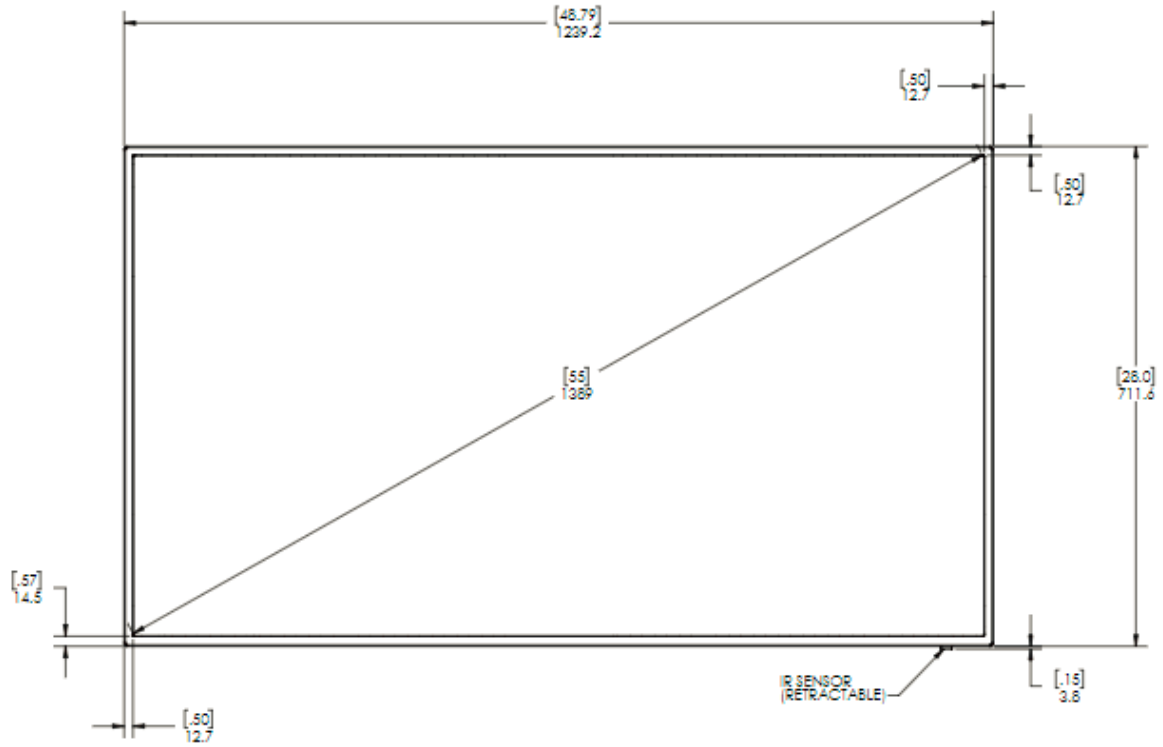

# SL6564K

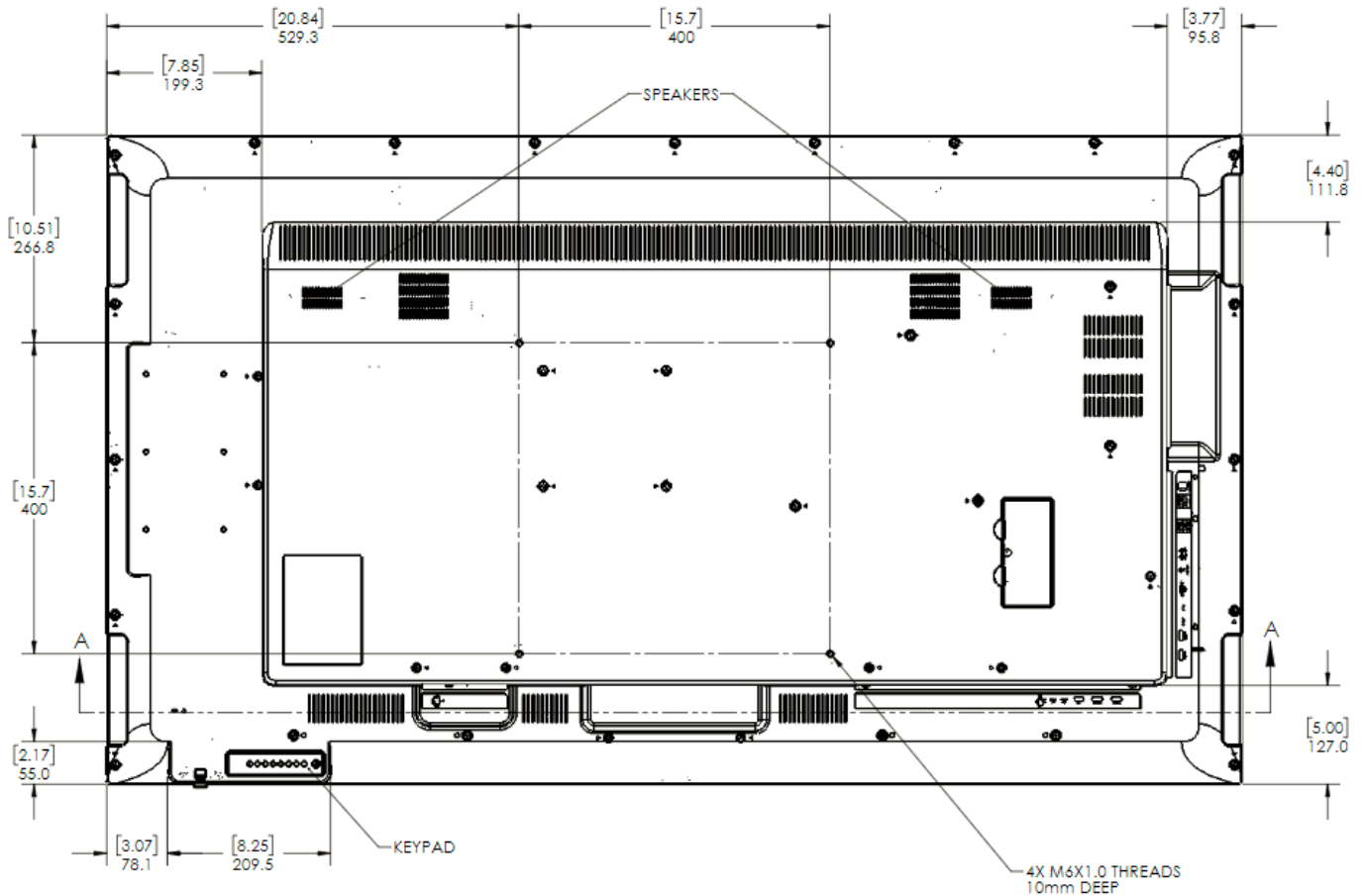
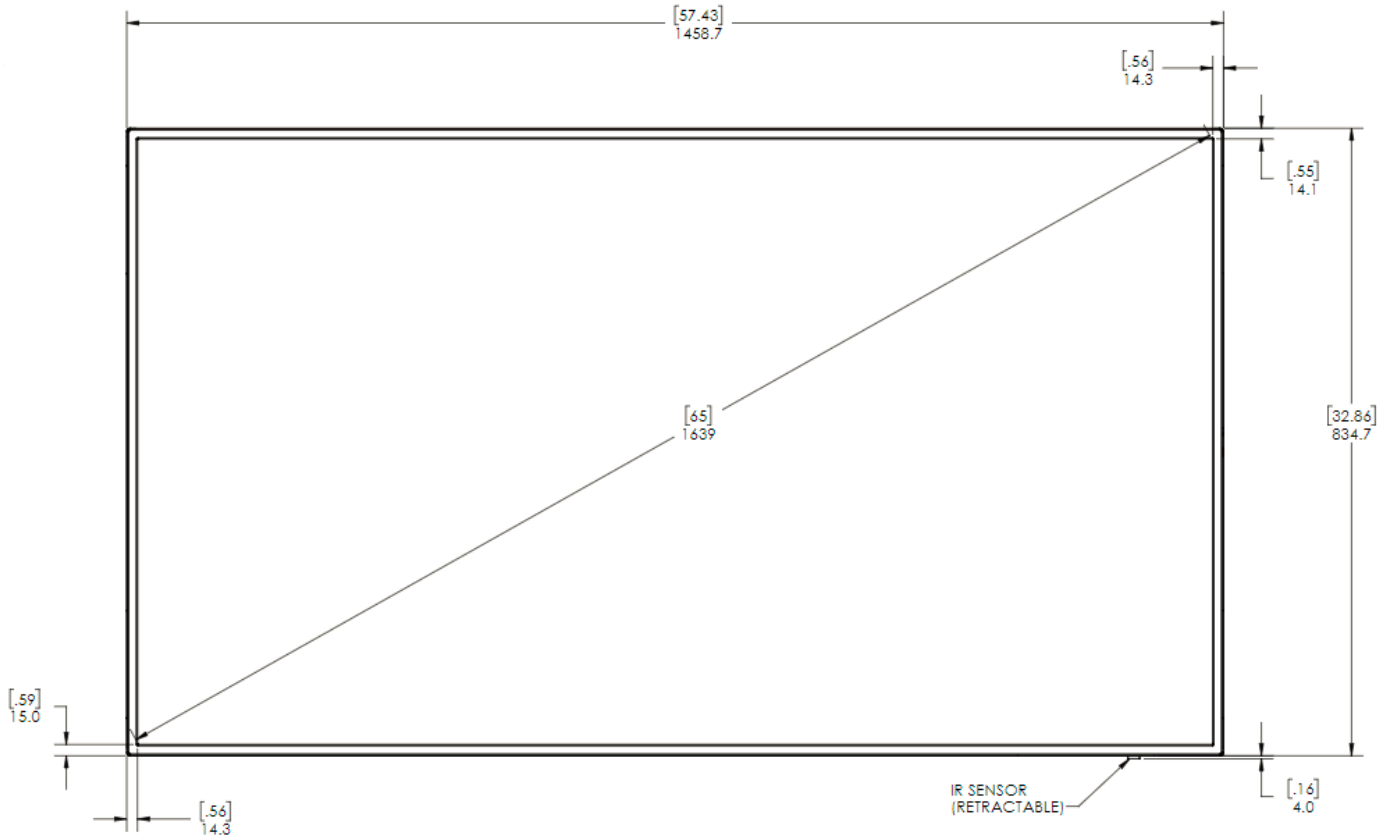

# SL7564K

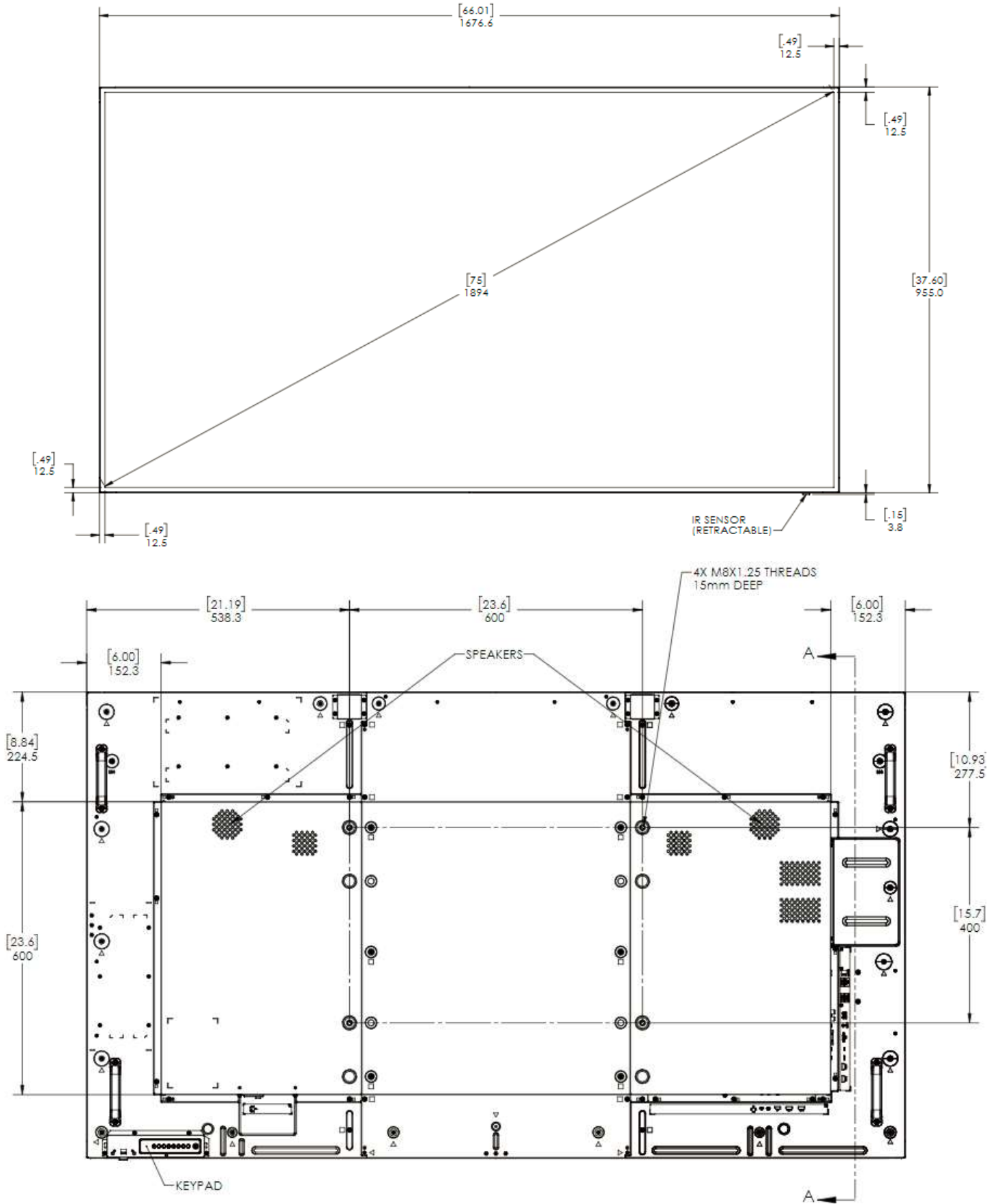

# SL8664K

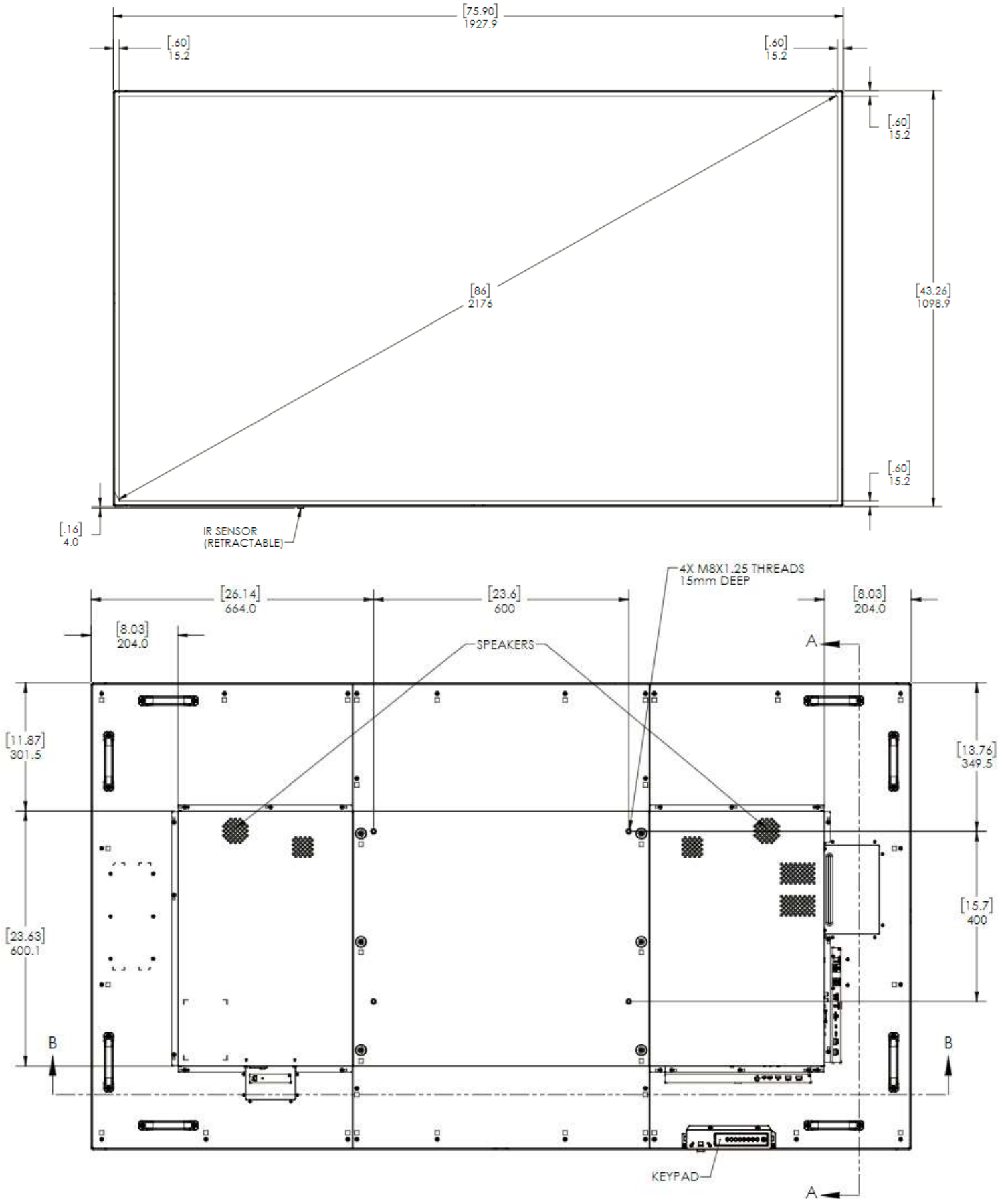

# Troubleshooting

Before calling service personnel, please check the following table for a possible cause of the problem you are experiencing. Please note the following:

- Perform the adjustments according to "Operating the Display" on [page 21](#).
- If the problem you are experiencing is not described below, or you cannot correct the problem, stop using the display and contact Planar's Technical Support Department. See "Accessing the Planar Technical Support Website" on [page 93](#).

Issue	Check for the following
No image is displayed	Make sure the correct source is selected.
	Make sure the main power switch is ON.
	Check that the source equipment is operating correctly.
	Make sure the input signal is compatible with this display.
The image is not centered	Make sure the input signal is compatible with this display.
The remote control doesn't work	Make sure the batteries are new and installed correctly. Ensure the remote is aimed at the IR sensor.
	Make sure the remote control sensor is plugged in correctly.
	Make sure the remote is aimed towards the back of the display where the sensor is located.
The picture color looks poor	Check the picture settings. Reset the display

# Accessing the Planar Technical Support Website

Go to <http://www.planar.com/support/> to locate the following support documents and resources:

- User Guide
- RS232 User Manual
- Standard Warranties
- CMS Software
- Planar support hotline number and email

# Index

## A

- Accessory Kit, 16
- Advanced Settings, 46
  - Reset, 49
- Android Settings Menu, 50
- Aspect Ratio, 38
- Audio, 40
  - Audio Out, 41
  - Audio Reset, 41
  - Audio Source, 41
- Audio Compatibility, 63

## B

- Batteries, 15

## C

- Cable Clips, 15
- Cable Length Recommendations, 19
- Cleaning the Display, 13
- Clone Media Files, 57
- CMS, 55
  - Device Menu, 75
  - PIN Code, 75
  - Schedule, 72
- Color Subsampling Support, 79
- Configuration 1, 42
- Configuration 2, 44
- Content Management System, 68
- Cooling Requirements, 11
- Custom Zoom, 38

## D

- Dimensions, 82
- Display, 58

## E

- Email Notification, 53
- Ethernet, 50
- External Control, 77
- External Storage, 55

## F

- Factory Reset, 43

## H

- HDMI
  - Installing the Display, 19
  - Package contents, 14

## I

- Image Compatibility, 63
- Important Waste Disposal Information, 11
- Input Menu, 32
- Installing OPS Expansion
- Installing the Display, 18

- IR Remote Key Codes, 25

## L

- LED Indicators, 23

## M

- Manual Setup
  - Signage Display Settings, 30
- Media Player, 62
- Monitor ID, 45

## N

- Network Setting, 29
- Normal Usage Guidelines, 11

## O

- Operating the Display, 21
- OPS, 20
- OSD Initial Settings Menu, 28
  - Keypad, 21
  - Main Menu, 33

## P

- Package Contents, 14
- Pairing the Remote Control
  - Remote Control, 26
- Plan Your Installation
- Power Save Mode, 49

## R

- Remote Control Receiver, 22

## S

- Safety, 8
- Schedule, 48
- Screen Reset, 39
- Signage Display, 51
  - Settings, 30
- Signal Compatibility, 78
- Simple Mail Transfer Protocol, 53
- Source Options, 33
- Supported Media Formats, 62
- System Tools, 56

## T

- Temporary Image Retention, 10
- Troubleshooting, 87

## V

- VESA Mounts, 12
- Volume, 3, 21, 27, 40, 41, 46

## W

- Warranty Coverage, 10