

# Next Generation MPR Series

modular raceway system

design and build a custom power distribution system to your specifications with the MPR series modular power raceway system

## features:

- Lightweight raceway with back-mount support clip that allows mounting in any position on a vertical or horizontal axis
- Raceway available in any of (4) standard lengths or can be cut to any custom length of 2" increments. See chart on next page for usable mounting space.
- Modules can be positioned anywhere along the raceway in 2" increments
- Basic and controlled (dry contact) power modules available in 15A, 20A & 30A
  - USC-6R, MPR-SEQA, MPR-SEQ-1CA or any maintained dry contact can be used for control
- Standard and isolated ground modules
- NEMA, IEC, Twist-lock, and Neutrik receptacles
- Convenient genderless connectors ensure fast & safe assembly (no hardwired inter-chassis connections)
- An open deep raceway, with no cross divider interference ensures fast and easy assembly
  - Threaded grooves along length of extrusion allow attachment of cable management ties for low voltage control
- Multiple junction box options supports different wiring applications & circuit termination capacity
- Laser Knock-Outs (LKO) in end caps for power connections
- Custom laser engraving available
- Standalone modules available (remote access)

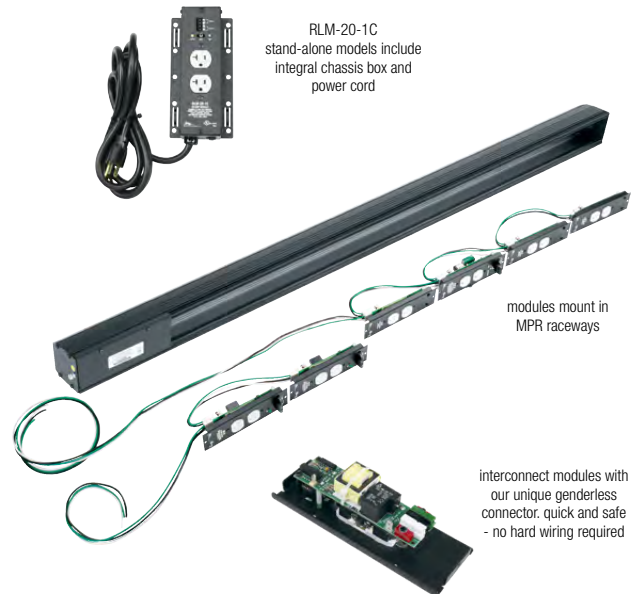

## specifications:

MPR modular raceways shall be Middle Atlantic Products model # MPR-xA (x = number 8" of modules accommodated) (See chart prior to determining x). Power modules shall be RLM-xxA, or M-xxA (refer to chart). Isolated ground outlets shall be available, suffix part with IG (ex. RLM-20IGA). Stand-alone power modules shall be RLM-xx-1CA and shall include a 9.5' SignalSAFE™ power cord with NEMA 5-15P plug or 5-20P plug. (See chart to determine which stand-alone power modules are suitable for your application). The MPR, RLM and M series shall be finished in durable black powder coat. MPR components shall be ETL Listed to UL Standard 5 and CSA C22.2 No.62 separately and as a system in the US and Canada. MPR shall be manufactured by an ISO 9001 registered company. MPR components shall be warranted to be free from defects in material and workmanship under normal use and conditions for a period of 3 years.

Customizable specification clips available at [middleatlantic.com](http://middleatlantic.com)



## options:

- JMS-12X6 Master / Slave Jumpers allow economical M Series modules to be switched remotely by an RLM Series module. Sold in packs of 6.
- MPR-SS transient voltage surge suppressor provides protection when mounted in raceways.
- J-XX6 Jumpers contain convenient genderless jumpers on each end. Sold in packs of 6 (x = jumper length) (See chart to determine which jumpers are suitable for your application).
- T-XX6 Tails contain a convenient genderless jumper on one end and wire-tails for J-box connection on the other. Sold in packs of 6 (x = tail length) (See chart to determine which tails are suitable for your application).
- MPR-BL\_\_A, blank covers, available in 2", 4" or 8" lengths (refer to chart)
- MPR-SEQA six-step sequencer fits in module opening of MPR raceway (See A&E spec sheet # 96-01062).
- MPR-JB\_\_ Junction Boxes available (refer to chart).
- 8" ground wires with termination rings for grounding stud shall be model # G-8X10. Sold in packs of 10.



WHAT GREAT SYSTEMS ARE BUILT ON™ | [LEGRANDAV.COM](http://LEGRANDAV.COM)

USA P 800.266.7225 E [av.middleatlantic.support@legrand.com](mailto:av.middleatlantic.support@legrand.com)  
 CANADA P 888.766.9770 E [av.middleatlantic.support@legrand.com](mailto:av.middleatlantic.support@legrand.com)

©2019 Middle Atlantic Products, Inc. All rights reserved. All other brand names or marks are used for identification purposes and are trademarks of their respective owners. All patents are protected under existing designations. Other patents pending.



COMMERCIAL BRANDS

C2G | Chief | Da-Lite | Luxul | Middle Atlantic | Vaddio | Wiremold

96-01173 / rev f / 5-26-20

# MPR Series

## next generation modular power raceways

all dimensions in inches unless otherwise noted [all dimensions in brackets are in millimeters]

side view

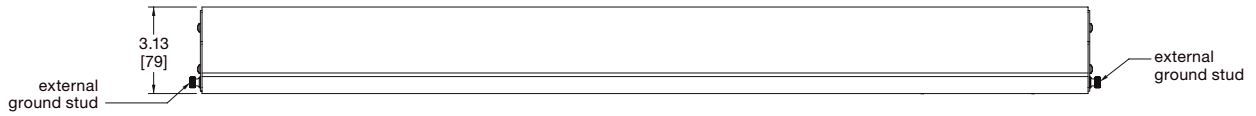

end view

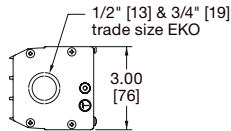

front view

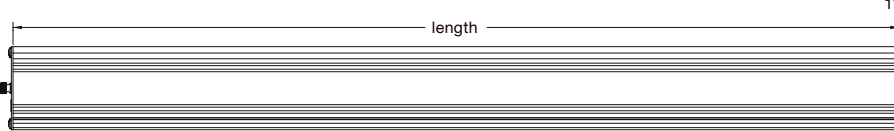

end view

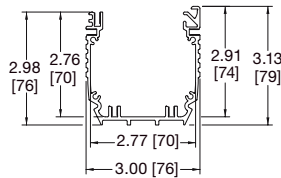
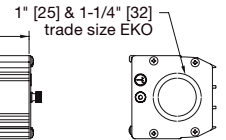

with RLM module

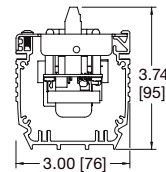

with M module

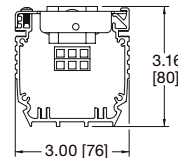

with Series Protection™  
RLM module

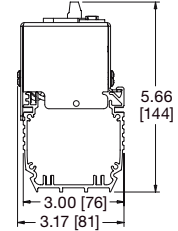

Note: sizes shown are typical, other lengths available in any length in 2" increments

Part #	Chassis Length	Usable Module Mounting Space Using Integral J-Box	Usable Module Mounting Space Using Optional J-Box
MPR-3A	32" [813]	24" [610]	32" [813]
MPR-6A	56" [1422]	48" [1219]	56" [1422]
MPR-8A	72" [1829]	64" [1626]	72" [1829]
MPR-9A	80" [2032]	72" [1829]	80" [2032]

- All MPR Series Raceways contain an integral J-box with cover
- All MPR Series Raceways feature electrical knockouts (1/2" and 3/4") on each end
- Mounting: quick clip (see details), 2 supplied per strip (MPR-3A), 3 supplied per strip (MPR-6A, 8A, and 9A)
- Use indoors in dry location only

module mounting

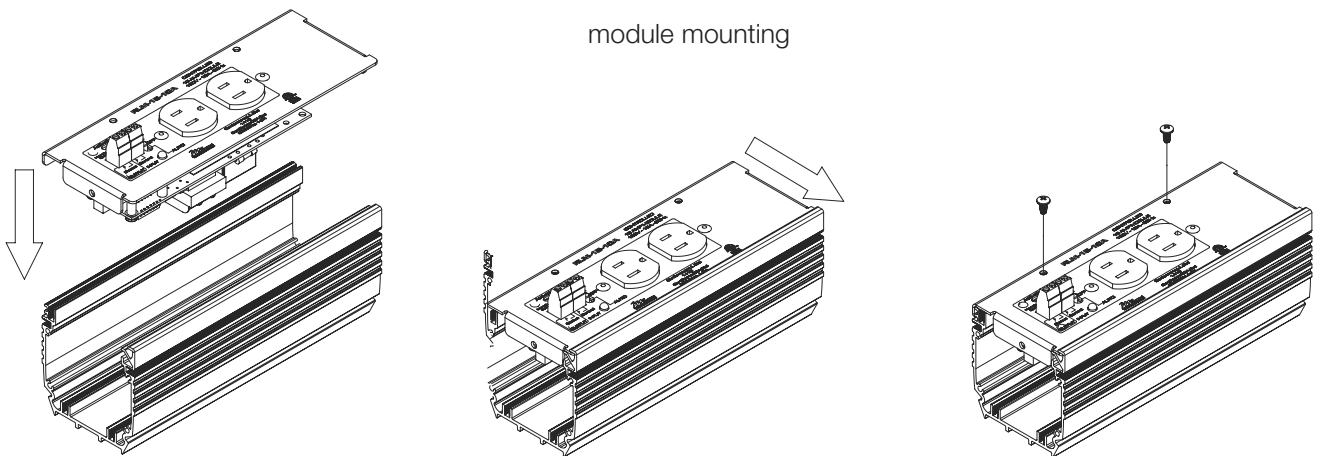

WHAT GREAT SYSTEMS ARE BUILT ON™ | LEGRANDAV.COM

USA P 800.266.7225 E av.middleatlantic.support@legrand.com  
CANADA P 888.766.9770 E av.middleatlantic.support@legrand.com

©2019 Middle Atlantic Products, Inc. All rights reserved. All other brand names or marks are used for identification purposes and are trademarks of their respective owners. All patents are protected under existing designations. Other patents pending.



COMMERCIAL BRANDS

C2G | Chief | Da-Lite | Luxul | Middle Atlantic | Vaddio | Wiremold

# MPR Series

## connections and included mounting method

all dimensions in inches unless otherwise noted [all dimensions in brackets are in millimeters]

### connections



J-12X6



Interconnect modules with our unique genderless connectors - no hard wiring required!

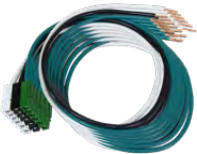

T-80X6

J series jumpers connect power modules, providing AC power to all modules on the same circuit. Jumpers are made from 65 strand, 12-gauge MTW wire for ease in routing. Pre-terminated jumpers feature convenient genderless 30A connectors at both ends and are sold in packs of six.

Part #	Jumper Length	Wire Specifications	Termination	Packaging	Use When
J-12X6	12"	12-gauge MTW, 20 amp	30A connector on each end	sold in packs of six	interconnecting modules not more than 8" apart
J-24X6	24"	12-gauge MTW, 20 amp	30A connector on each end	sold in packs of six	interconnecting modules not more than 16" apart
J-72X6	72"	12-gauge MTW, 20 amp	30A connector on each end	sold in packs of six	interconnecting modules more than 16" apart

T series tails connect incoming power to a single circuit within a raceway. Tails are made from 65 strand, 12-gauge MTW wire for ease in routing. One tail required per circuit. Each tail features a pre-terminated 30A connector that plugs in to a module at one end, and wire tails for J-box connection on the other. Sold in packs of six.

Part #	Jumper Length	Wire Specifications	Termination	Packaging	Use When
T-24X6	24"	12-gauge MTW, 20 amp	connector one end, tails on the other	sold in packs of six	connecting modules not more than 16" from J-Box
T-80X6	80"	12-gauge MTW, 20 amp	connector one end, tails on the other	sold in packs of six	connecting modules more than 16" from J-Box

JMS series master / slave jumpers allow economical M series modules to be switched remotely by an RLM series module.

Part #	Jumper Length	Wire Specifications	Termination	Packaging	Use When
JMS-12X6	12"	12-gauge MTW, 20 amp	connector on one end, connector plus push-on terminal on the other	sold in packs of six	connecting M series modules to be switched remotely by an RLM or R series module

### included mounting method

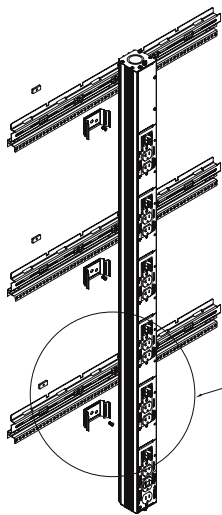

Middle Atlantic Rackrail Bracket

quick-clip (2 provided on MPR-3A; 3 provided for larger sizes)



WHAT GREAT SYSTEMS ARE BUILT ON™ | LEGRANDAV.COM

USA P 800.266.7225 E av.middleatlantic.support@legrand.com  
 CANADA P 888.766.9770 E av.middleatlantic.support@legrand.com

©2019 Middle Atlantic Products, Inc. All rights reserved. All other brand names or marks are used for identification purposes and are trademarks of their respective owners. All patents are protected under existing designations. Other patents pending.



COMMERCIAL BRANDS

C2G | Chief | Da-Lite | Luxul | Middle Atlantic | Vaddio | Wiremold

# MPR Series

## controlled modules

all dimensions in inches unless otherwise noted [all dimensions in brackets are in millimeters]

RLM-15A

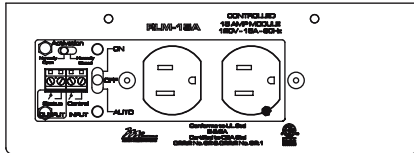

FC-4A

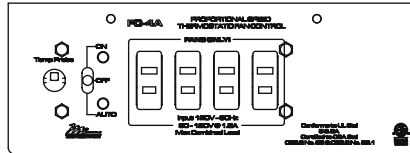

MPR-SEQA

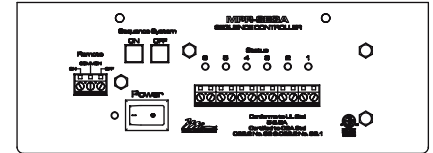

RLM-20A

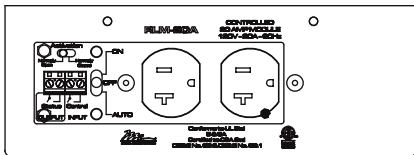

RLM-20IGA

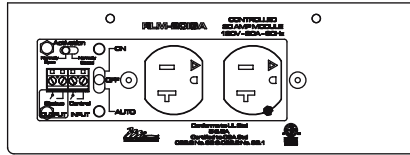

RLM-30TL-HWIGA

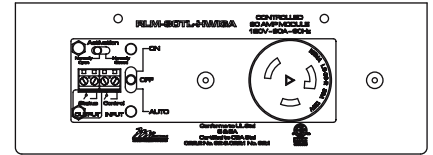

Note: all modules operate at 120 VAC, 60Hz

Full-featured RLM Series Modules can be switched remotely via contact closure by any control system that provides normally open, normally closed, maintained control, as well as with the local switch provided (factory default is normally open). Units provide contact closure status output, and include a local status LED. M Series Modules are always on

and cannot be switched remotely unless used in conjunction with a RLM Series module and JMS Series master / slave jumper. Modules with remote control shall be controlled by the Middle Atlantic USC-6R controller, MPR-SEQA sequencer or by any control system that provides contact closure outputs (depending on module selected).

Part #	Max. Load (Amps)	Description	Status Indication	Control	Outlets	Length
RLM-15A	15	Controlled module	LED and contact closure	Local and remote control	(2) 5-15R	8" [203]
RLM-20A	20	Controlled module	LED and contact closure	Local and remote control	(2) 5-20R	8" [203]
RLM-20IGA	20	Controlled module Isolated ground	LED and contact closure	Local and remote control	(2) 5-20R IG	8" [203]
FC-4A	1.5A	Proportional speed Thermostatic fan control	Power LED and fan speed LED	Temperature probe and always on	(4) 1-15R	8" [203]
MPR-SEQA	0.5A switching 1.2A carry, per channel	6 Channel sequencer Dry contact output	Power LED and LED per channel	Local and remote control	Terminal block/ Dry contact (6 channels)	8" [203]
RLM-30TL-HWIGA	30	Controlled module Isolated ground Hardwired	LED and contact closure	Local and remote control	(1)L5-30R-IG	8" [203]



WHAT GREAT SYSTEMS ARE BUILT ON™ | LEGRANDAV.COM

USA P 800.266.7225 E av.middleatlantic.support@legrand.com  
CANADA P 888.766.9770 E av.middleatlantic.support@legrand.com

©2019 Middle Atlantic Products, Inc. All rights reserved. All other brand names or marks are used for identification purposes and are trademarks of their respective owners. All patents are protected under existing designations. Other patents pending.



COMMERCIAL BRANDS

C2G | Chief | Da-Lite | Luxut | Middle Atlantic | Vaddio | Wiremold

# MPR Series

## Series Protection™ modules

all dimensions in inches unless otherwise noted [all dimensions in brackets are in millimeters]

US PATENT # 8,947,844

always on modules

M-15A-SP

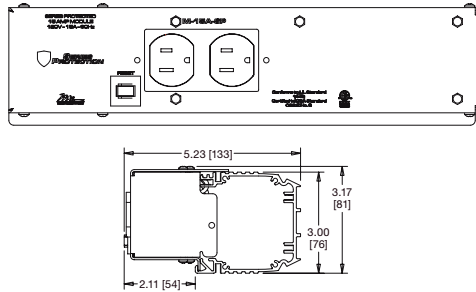

M-20A-SP

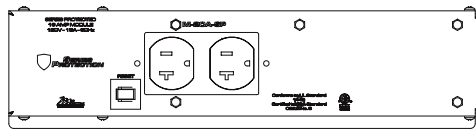

controlled modules

RLM-15A-SP

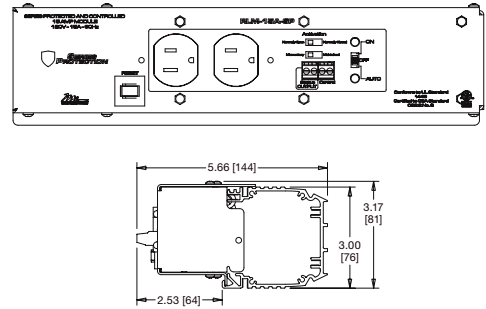

RLM-20A-SP

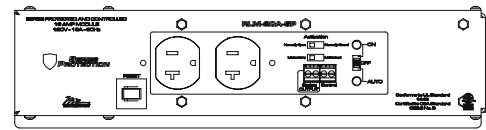

Part #	Max. Load (Amps)	Control	Input Voltage	Circuits	Outlets	Length
M-15A-SP	12	always on or JMS jumper *	120 VAC 60 Hz	1	(2) 5-15R	12 [305]
M-20A-SP	16	always on or JMS jumper *	120 VAC 60 Hz	1	(2) 5-20R	12 [305]

Part #	Max. Load (Amps)	Description	Status Indication	Control	Outlets	Length
RLM-15A-SP	12	controlled module	LED and contact closure	local and remote control	(2) 5-15R	12 [305]
RLM-20A-SP	16	controlled module	LED and contact closure	local and remote control	(2) 5-20R	12 [305]



WHAT GREAT SYSTEMS ARE BUILT ON™ | LEGRANDAV.COM

USA P 800.266.7225 E av.middleatlantic.support@legrand.com  
 CANADA P 888.766.9770 E av.middleatlantic.support@legrand.com

©2019 Middle Atlantic Products, Inc. All rights reserved. All other brand names or marks are used for identification purposes and are trademarks of their respective owners. All patents are protected under existing designations. Other patents pending.



COMMERCIAL BRANDS

C2G | Chief | Da-Lite | Luxul | Middle Atlantic | Vaddio | Wiremold

# MPR Series

always on modules

all dimensions in inches unless otherwise noted [all dimensions in brackets are in millimeters]

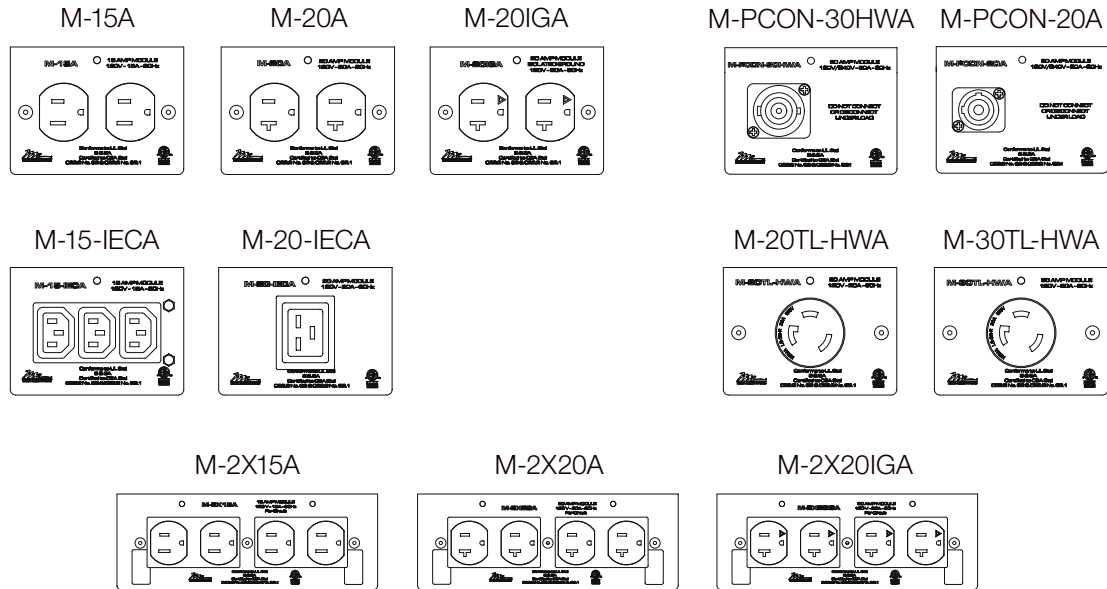

- Modules on the same circuit shall interconnect using J series jumpers, which feature # 12 (20 amp) wire with genderless 30 amp connectors at both ends and require no hard wiring.\*
  - All modules on separate circuits shall connect using T series tails, which feature # 12 (20 amp) wire with genderless appliance-grade 30 amp connector on one end and wire tails for J-box connection on the other.\*
  - Two duplexes on M-2X modules can be fed by two separate circuits. Remove the factory-installed jumpers (line & neutral) and feed each duplex using two T series tails.\*
  - Isolated ground outlets shall not be mixed with non-isolated ground modules on the same circuit.\*
  - The modules shall be attached to MPR raceways using one or more screws (provided).
- \* Does not apply to stand-alone modules

Part #	Max. Load (Amps)	Control	Input Voltage	Circuits	Outlets	Length
M-15A	15	Always on or JMS jumper *	120 VAC 60Hz	1	(2) 5-15R	4" [102]
M-20A	20	Always on or JMS jumper *	120 VAC 60Hz	1	(2) 5-20R	4" [102]
M-20IGA	20	Always on or JMS jumper *	120 VAC 60Hz	1	(2) 5-20R IG	4" [102]
M-2X15A	15 per circuit	Always on or JMS jumper *	120 VAC 60Hz	1 or 2, field configurable	(4) 5-15R	8" [203]
M-2X20A	20 per circuit	Always on or JMS jumper *	120 VAC 60Hz	1 or 2, field configurable	(4) 5-20R	8" [203]
M-2X20IGA	20 per circuit	Always on or JMS jumper *	120 VAC 60Hz	1 or 2, field configurable	(4) 5-20R IG	8" [203]
M-15IECA	15	Always on or JMS jumper *	120 VAC 60Hz	1	(3) C-13	4" [102]
M-20IECA	20	Always on or JMS jumper *	120 VAC 60Hz	1	(1) C-19	4" [102]
M-20TL-HWA	20	Always on	120 VAC 60Hz	hardwired **	(1) L5-20R	4" [102]
M-30TL-HWA	30	Always on	120 VAC 60Hz	hardwired **	(1) L5-30R	4" [102]
M-PCON-20A	20	Always on or JMS jumper *	120/240 VAC 60Hz	1	(1) NAC3MPB	4" [102]
M-PCON-30HWA	30	Always on	120/240 VAC 60Hz	hardwired **	(1) NAC3MP-HC	4" [102]

\* JMS jumpers allow control of "M" modules by an "RLM" module.

\*\* hardwired only not compatible with standard "J" or "JMS" type jumpers or T-type tails.



WHAT GREAT SYSTEMS ARE BUILT ON™ | LEGRANDAV.COM

USA P 800.266.7225 E av.middleatlantic.support@legrand.com  
 CANADA P 888.766.9770 E av.middleatlantic.support@legrand.com

©2019 Middle Atlantic Products, Inc. All rights reserved. All other brand names or marks are used for identification purposes and are trademarks of their respective owners. All patents are protected under existing designations. Other patents pending.



COMMERCIAL BRANDS

C2G | Chief | Da-Lite | Luxul | Middle Atlantic | Vaddio | Wiremold

# MPR Series

## junction boxes and blank covers

all dimensions in inches unless otherwise noted [all dimensions in brackets are in millimeters]

### junction boxes

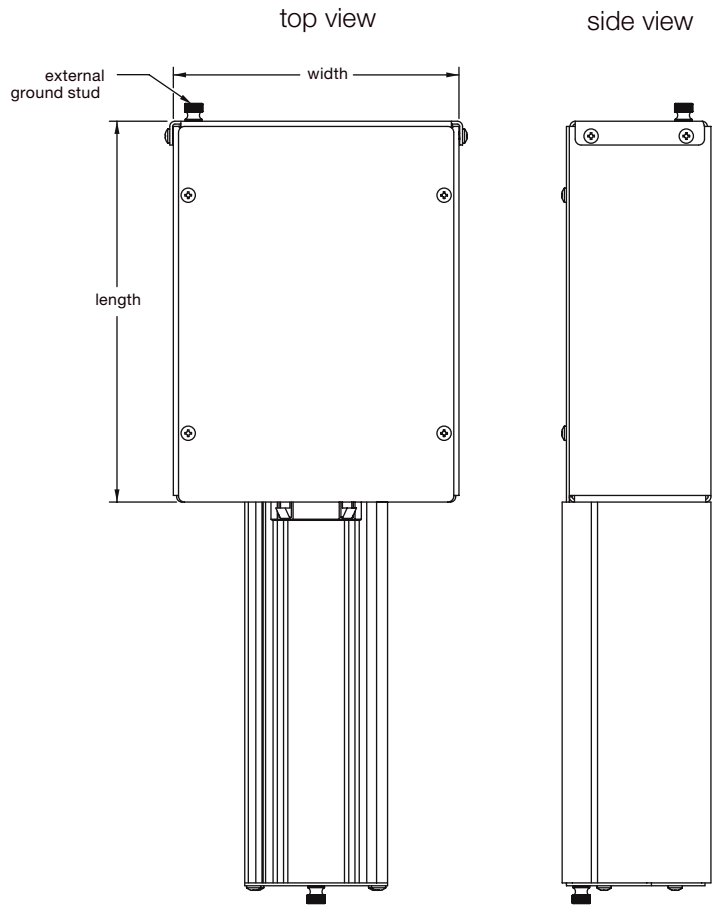
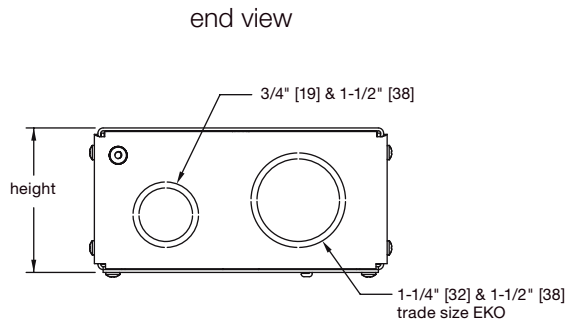

Part #	Length	Width	Height	Volume (cu in)
MPR-JB863A	8.00 [203]	6.00 [152]	3.00 [76]	129.44 [2121 cu cm]
MPR-JB853A	8.00 [203]	5.00 [127]	3.00 [76]	107.04 [1754 cu cm]
MPR-JB843A	8.00 [203]	4.00 [102]	3.00 [76]	84.65 [1387 cu cm]
MPR-JB663A	6.00 [152]	6.00 [152]	3.00 [76]	95.55 [1566 cu cm]

### blank covers

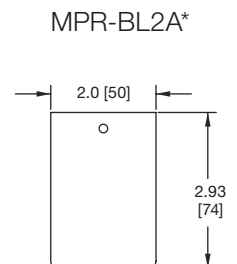
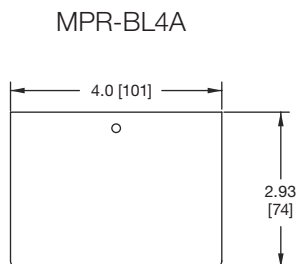
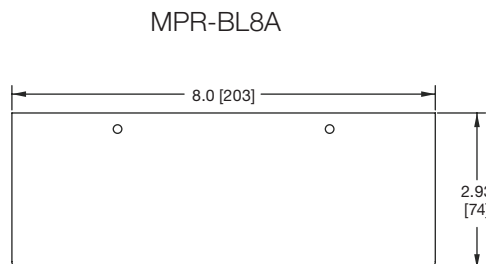

\* includes 2 qty blank covers



WHAT GREAT SYSTEMS ARE BUILT ON™ | [LEGRANDAV.COM](http://LEGRANDAV.COM)

USA P 800.266.7225 E [av.middleatlantic.support@legrand.com](mailto:av.middleatlantic.support@legrand.com)  
 CANADA P 888.766.9770 E [av.middleatlantic.support@legrand.com](mailto:av.middleatlantic.support@legrand.com)

©2019 Middle Atlantic Products, Inc. All rights reserved. All other brand names or marks are used for identification purposes and are trademarks of their respective owners. All patents are protected under existing designations. Other patents pending.



COMMERCIAL BRANDS

C2G | Chief | Da-Lite | Luxul | Middle Atlantic | Vaddio | Wiremold

# MPR Series

## standalone modules

all dimensions in inches unless otherwise noted [all dimensions in brackets are in millimeters]

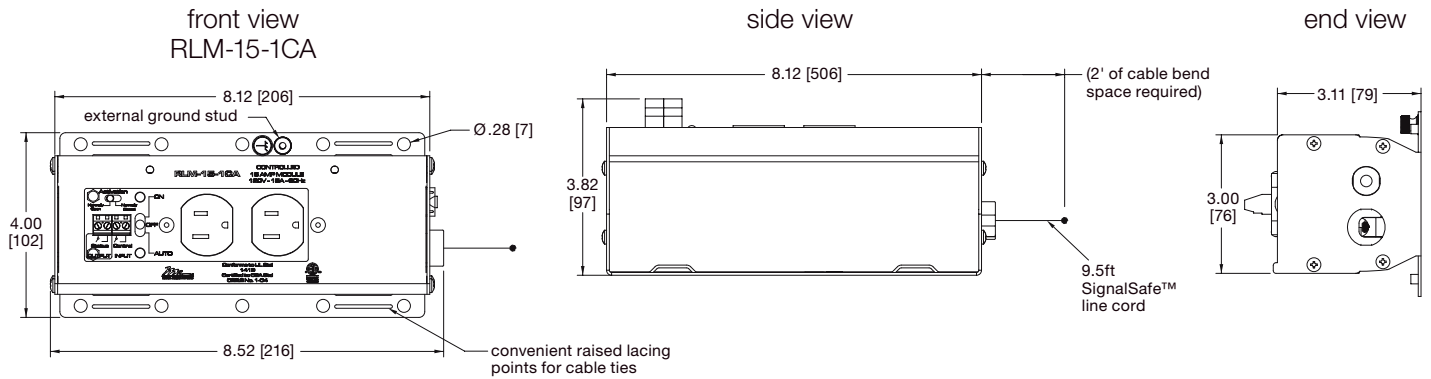

RLM-15-1CA

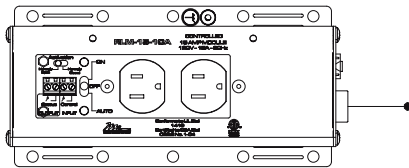

RLM-20-1CA

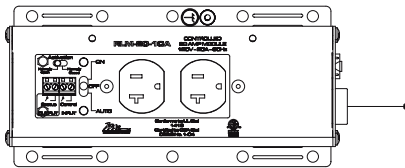

FC-2-215-1CA

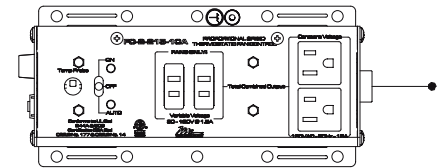

FC-4-1CA

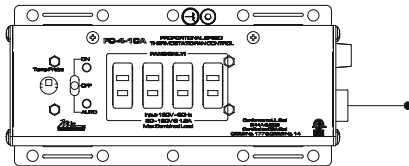

MPR-SEQ-1CA

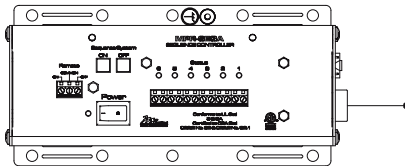

Part #	Max. Load (Amps)	Description	Status Indication	Control	Outlets	Power Supply Cord	
						AWG	PLUG
RLM-15-1CA	15	controlled module	LED and contact closure	local and remote control	(2) 5-15R	14-3	5-15P
RLM-20-1CA	20	controlled module	LED and contact closure	local and remote control	(2) 5-20R	12-3	5-20P
FC-2-215-1CA	15	fan control with 2 always on outlets	power LED and fan speed LED	temperature probe and always on	(2) 1-15R (2) 5-15R	14-3	5-15P
FC-4-1CA	1.5	proportional speed thermostatic fan control	power LED and fan speed LED	temperature probe and always on	(4) 1-15R	18-3	5-15P
MPR-SEQ-1CA	0.5A switching 1.2A carry, per channel	6 channel sequencer dry contact output	power LED and LED per channel	local and remote control	terminal block/ dry contact (6 channels)	14-3	5-15P



WHAT GREAT SYSTEMS ARE BUILT ON™ | LEGRANDAV.COM

USA P 800.266.7225 E av.middleatlantic.support@legrand.com  
CANADA P 888.766.9770 E av.middleatlantic.support@legrand.com

©2019 Middle Atlantic Products, Inc. All rights reserved. All other brand names or marks are used for identification purposes and are trademarks of their respective owners. All patents are protected under existing designations. Other patents pending.



COMMERCIAL BRANDS

C2G | Chief | Da-Lite | Luxut | Middle Atlantic | Vaddio | Wiremold