

INTERNATIONAL master catalog



racks & enclosures | essex | technical furniture | power | accessories

what **great systems** are built on.™

MA
Middle Atlantic Products

A brand of **legrand**



what great systems
are built on.™

Middle Atlantic Products, a Group Brand Legrand® has manufactured exceptional support & protection products to mount integrated AV systems in Residential, Commercial, Broadcast and Security applications since 1979.

All of our products are designed and engineered in the US to maximize system reliability and to meet the needs of installers; from thermal considerations and built-in cable management, to pre-installed

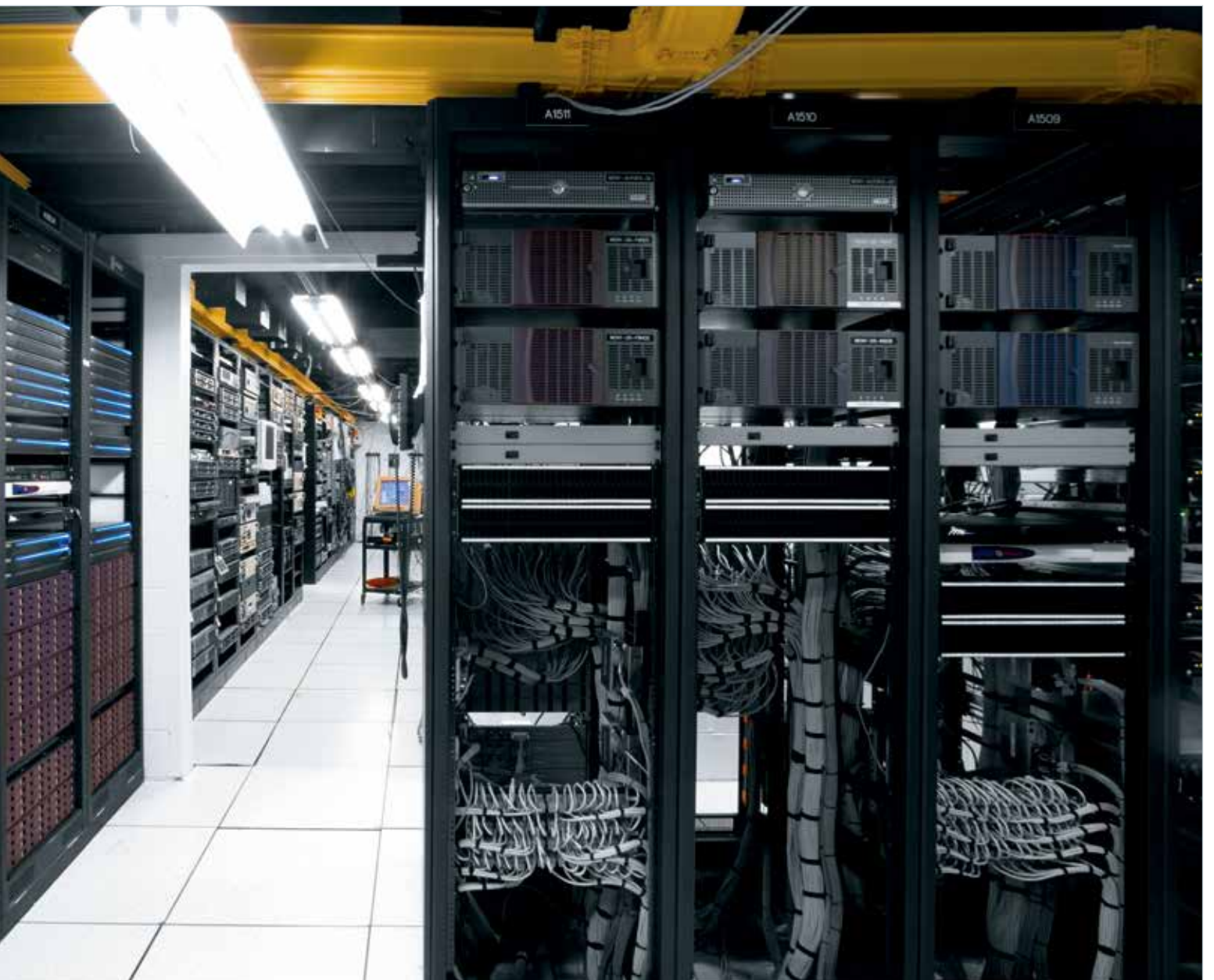

washers on our rack screws, we build in ways to save time and simplify the job.

At the heart of every installation, you'll find Middle Atlantic Products - what great systems are built on.

A brand of  **legrand**



customer first philosophy

Our philosophy began as, and will always be, Customers First. Middle Atlantic's customer service team, technical support group & custom division are fully dedicated resources to ensure that we provide the right product and solution at the right time to meet our customers' needs.

Our 425,000 square foot headquarters is equipped with manufacturing capabilities such as laser-fabrication cells which produce smooth edges



that are friendly to both cables and contractors, automated forming lines, robots and high-speed turret presses that provide quick throughput.

It's these resources that allowed us to revolutionize the industry by stocking products nationwide to be ready on a moments notice.

We've developed the broadest and deepest product lines in the industry – maximizing our customers'

options, helping them consolidate vendors all while staying close to our core offering and expertise to ensure a value added experience.



Photo courtesy of Peter Shipp

table of contents

racks and enclosures



Gangable Floor-Standing Enclosures	12 - 29
BGR Series	12 - 13
SNE Series	14 - 15
MRK Series	16 - 17
VRK Series	18 - 19
VMRK Series	20 - 21
WMRK Series	22 - 23
WRK Series	24 - 25
DRK Series	26 - 27
Slim 5 Series	28 - 29
Stand-Alone Floor-Standing Enclosures	32 - 55
BGR-SA Series	32 - 33
BGR Series Presentation Enclosure	34 - 35
WRK-SA Series	36 - 37
WRK-24MDK Series	38 - 39
ERK Series	40 - 41
ERK-KD Series	42 - 43
Options	44 - 50
SRB Series Riser Bases	51
Raised Floor Enclosure Support System™	52 - 53
Configured Enclosure Systems	54 - 55
Wall Mount Racks and Cabinets	58 - 77
SR Series	58 - 59
DWR Series	60 - 61
EWR Series	62 - 63
CWR Series	64 - 65
SWR and SBX Series	66 - 67
TOR and WRS/WRP Series	68 - 69
SFR and WM Series	70 - 71
HDR and SPM Series	72 - 73
VPM and PPM Series	74 - 75
HPM and DLBX/VLBX Series	76 - 77
Slide Out Racks	80 - 93
WR Series	80 - 81
AXS Series	82 - 85
AX-SXR Series	86 - 87
ASR-HD Series	88 - 89
ASR and REB Series	90 - 91
SRSR and SRS Series	92 - 93
Specialty Racks	94 - 111
MFR and RFR Series	96 - 97
RK/BRK, OBRK and MBRK Series	98 - 99
OSR and SRK Series	100 - 101
Slim 2 and DR Series	102 - 103
PTRK and ISRK Series	104 - 105
HRF Series	106 - 107
CFR Series	108 - 109
IDF and DTRK Series	110 - 111
2 and 4 Post Racks	114 - 119
R4 Series	114 - 115
MK Series	116 - 117
RL/RLA Series and R2 Series	118 - 119

essex by Middle Atlantic



QAR Series	122 - 123
MMR Series	124 - 125
RCS Series	126 - 127
Power Options	128
Accessory Bundles	129
Accessory Options	130 - 131

technical furniture



Frame To Furniture™	134 - 139
C5 Series Credenzas	134 - 135
L5 Series Lecterns	136 - 137
TechPed™ Series Technology Pedestals	138 - 139
Consoles/Workstations	140 - 153
ViewPoint™ Series	140 - 143
Options	144 - 147
Edit Center™ Series	148 - 149
LD Series	150 - 151
MultiDesk Video™ Series	152 - 153
Carts & Stands	154 - 159
Monitoring/Display Walls	160 - 163

power



Uninterruptible Power Supplies (UPS)	166 - 167
Horizontal Power Distribution	168 - 175
Vertical Power Distribution	176 - 179
Custom Power	180 - 182
Isolation Transformers	183 - 184
Power Accessories	185 - 187

accessories



Shelves & Storage	190 - 203
Custom Rackshelves	190 - 191
Adjustable & Sliding Shelves	192 - 193
Rackshelves	194 - 197
Media Player & Keyboard Shelves	198 - 199
LCD Rackmounts & Other Shelves	200 - 201
Rackmount Storage	202 - 203
Lever Lock™	206 - 207
Cable Management	210 - 219
Horizontal	210 - 213
Vertical	214
Cable Ducts & Chases	215 - 216
Cable Ladders	217 - 218
Accessories	219
Thermal Management	222 - 227
Rackmount Consoles	228
Lighting	229
Security Options & Covers	230 - 231
Blank & Vent Panels	232 - 239
Connector Panels	237 - 239
Hardware & Accessories	240 - 245

resources



E-Tools	246 - 248
Finishes	249
Alpha-Numeric Index	250 - 251



racks and enclosures



essex by Middle Atlantic



technical furniture



power



accessories



resources



Photo courtesy of Peter Shipp.

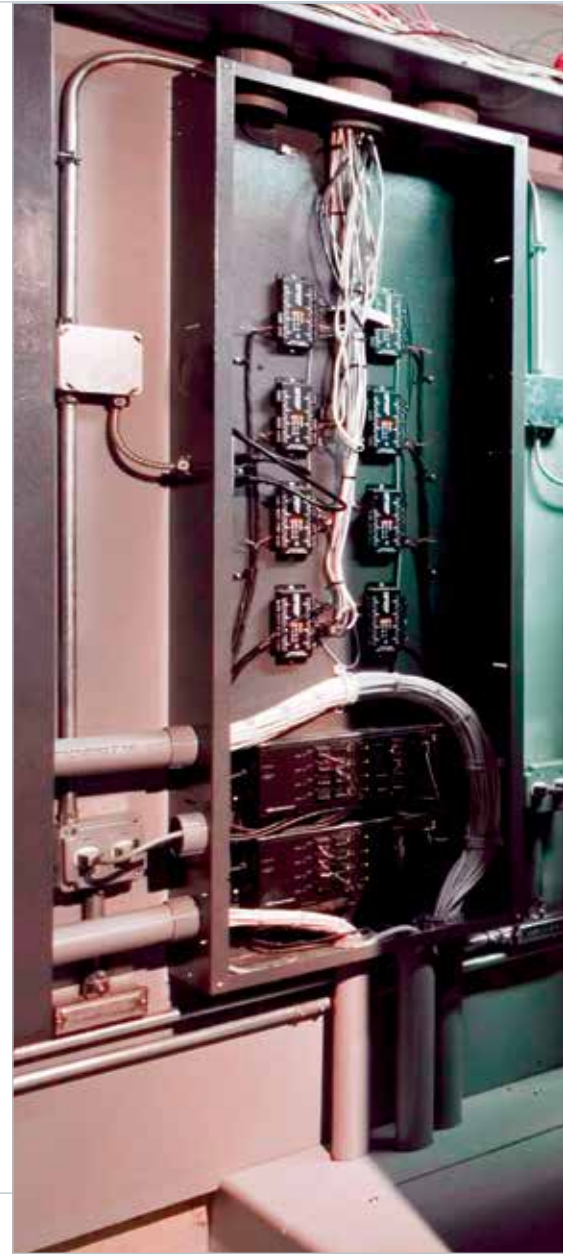

racks and enclosures

Racks and enclosures form the primary structure of an installation, and provide the “frame” to support electronic equipment, power, cooling and cable management.

Middle Atlantic offers the broadest and deepest range of rack solutions in the industry to meet the needs of almost any application and maximize your options. Explore the products in the following pages or visit middleatlantic.com to find the perfect solution for you.





gangable floor-standing enclosures

Gangable racks are designed for larger installations where more than one rack is needed. Normally, they are floor-standing and feature large openings on the sides as well as front and back, and have holes or pre-installed nuts that allow the racks to be bolted together side-to-side.

(Some installers also prefer them for single-rack jobs because the open sides provide unrestricted access during installation.)



Attaching the racks firmly together provides strength, stability, and allows cabling to pass between racks. Side panel sets are available to cover the sides once the installation is complete; one set of side panels will close off an entire row of ganged racks.

Most floor-standing gangable racks range in capacity from 19 to 44 or 45 spaces, with the Extra Tall VMRK having up to 54 spaces.

Solutions are also available to close off one or more sides in the middle of a row of ganged racks – perfect for blocking airflow from one rack to the next.

BGR Series	12 - 13
SNE Series	14 - 15
MRK Series	16 - 17
VRK Series	18 - 19
VMRK Series	20 - 21
WVRK Series	22 - 23
WRK Series	24 - 25
DRK Series	26 - 27
Slim 5 Series	28 - 29



highest level of integration flexibility



The **BGR Series** innovative rack delivers the highest level of integration flexibility and space efficiency.

- Designed to accommodate evolving AV systems
- Breakthrough design provides high strength without extra weight
- Wide open top and bottom offer many cabling and cooling options
- Standard front and rear adjustable 10-32 threaded rackrail with numbered spaces
- Includes standard vented rear door that accepts optional fans (except LRD models)
- Accepts Lever Lock™ system tool free cable management accessories, see pg. 206
- Accepts extender bay to add 76mm of useable depth to the front or rear at any time
- Accepts brush grommet rear door kit for a large cable passage without fishing



Certifications

- Seismic Certification
- UL/ETL Listed
- RoHS
- GREENGUARD

Market Solutions



Broadcast



Commercial
AV



Residential
AV



Security



Structured
Cabling



Education



International
Fan Available

Power Solutions



100VAC – 2240VAC | 50/60Hz Compatible



Product Information

Part #	Racking Height	Overall Height	Overall Depth	Useable Depth	Side Panels	Add'l 10/32 Threaded Rackrail (Pair)	Accent Trim (Silver)*
BGR-1927	845mm (19 space)	949mm	686mm	619mm	BSPN-19-27	BGR-RR19	BGR-TRIM19
BGR-2527	1111mm (25 space)	1216mm	686mm	619mm	BSPN-25-27	BGR-RR25	BGR-TRIM25
BGR-2532	1111mm (25 space)	1216mm	813mm	746mm	BSPN-25-32	BGR-RR25	BGR-TRIM25
BGR-3827	1689mm (38 space)	1794mm	686mm	619mm	BSPN-38-27	BGR-RR38	BGR-TRIM38
BGR-3832	1689mm (38 space)	1794mm	813mm	746mm	BSPN-38-32	BGR-RR38	BGR-TRIM38
BGR-4127	1822mm (41 space)	1927mm	686mm	619mm	BSPN-41-27	BGR-RR41	BGR-TRIM41
BGR-4132	1822mm (41 space)	1927mm	813mm	746mm	BSPN-41-32	BGR-RR41	BGR-TRIM41
BGR-4138	1822mm (41 space)	1927mm	965mm	899mm	BSPN-41-38	BGR-RR41	BGR-TRIM41
BGR-4527	2000mm (45 space)	2105mm	686mm	619mm	BSPN-45-27	BGR-RR45	BGR-TRIM45
BGR-4532	2000mm (45 space)	2105mm	813mm	746mm	BSPN-45-32	BGR-RR45	BGR-TRIM45
BGR-4538	2000mm (45 space)	2105mm	965mm	899mm	BSPN-45-38	BGR-RR45	BGR-TRIM45

*available without rear door, suffix part # 'LRD' *accent trim also available in black, suffix part # 'B'

Options

Please refer to the enclosure options section on pgs. 44-50 or visit our website for more info.

Fits Part #	Front Doors					Rear Doors	Solid Top	Top Rail Reducer	Vented Top	Fan Tops			
	Solid	Plexi	Vented	Curved Door Vented	Curved Door Plexi	Cable Entry Rear Door**				15,63m ³ /min	7,82m ³ /min	15,63m ³ /min with Controller	7,82m ³ /min with Controller
BGR-1927	BFD-19	BPFD-19	BVFD-19	VFD-19A	PFD-19A	BGR-RDC19	-	-	-	-	-	-	-
BGR-2527	BFD-25	BPFD-25	BVFD-25	VFD-25A	PFD-25A	BGR-RDC25	-	-	-	-	-	-	-
BGR-2532	BFD-25	BPFD-25	BVFD-25	VFD-25A	PFD-25A	BGR-RDC25	-	-	-	-	-	-	-
BGR-3827	BFD-38	BPFD-38	BVFD-38	VFD-38A	PFD-38A	BGR-RDC38	BGR-STP9	BGR-TRR9	BGR-LVT9	IBGR-552FT	IBGR-276FT	IBGR-552FT-FC	IBGR-276FT-FC
BGR-3832	BFD-38	BPFD-38	BVFD-38	VFD-38A	PFD-38A	BGR-RDC38	BGR-STP9	BGR-TRR9	BGR-LVT9	IBGR-552FT	IBGR-276FT	IBGR-552FT-FC	IBGR-276FT-FC
BGR-4127	BFD-41	BPFD-41	BVFD-41	VFD-41A	PFD-41A	BGR-RDC41	BGR-STP9	BGR-TRR9	BGR-LVT9	IBGR-552FT	IBGR-276FT	IBGR-552FT-FC	IBGR-276FT-FC
BGR-4132	BFD-41	BPFD-41	BVFD-41	VFD-41A	PFD-41A	BGR-RDC41	BGR-STP9	BGR-TRR9	BGR-LVT9	IBGR-552FT	IBGR-276FT	IBGR-552FT-FC	IBGR-276FT-FC
BGR-4138	BFD-41	BPFD-41	BVFD-41	VFD-41A	PFD-41A	BGR-RDC41	BGR-STP9	BGR-TRR9	BGR-LVT9	IBGR-552FT	IBGR-276FT	IBGR-552FT-FC	IBGR-276FT-FC
BGR-4527	BFD-45	BPFD-45	BVFD-45	VFD-45A	PFD-45A	BGR-RDC45	BGR-STP9	BGR-TRR9	BGR-LVT9	IBGR-552FT	IBGR-276FT	IBGR-552FT-FC	IBGR-276FT-FC
BGR-4532	BFD-45	BPFD-45	BVFD-45	VFD-45A	PFD-45A	BGR-RDC45	BGR-STP9	BGR-TRR9	BGR-LVT9	IBGR-552FT	IBGR-276FT	IBGR-552FT-FC	IBGR-276FT-FC
BGR-4538	BFD-45	BPFD-45	BVFD-45	VFD-45A	PFD-45A	BGR-RDC45	BGR-STP9	BGR-TRR9	BGR-LVT9	IBGR-552FT	IBGR-276FT	IBGR-552FT-FC	IBGR-276FT-FC

**Order with part # 'LRD'

Front Trim Kit Part # (Silver)	Front Trim Kit Part # (Black)	Fits
BGR-TRIM19	BGR-TRIM19B	BGR 19 space racks
BGR-TRIM25	BGR-TRIM25B	BGR 25 space racks
BGR-TRIM38	BGR-TRIM38B	BGR 38 space racks
BGR-TRIM41	BGR-TRIM41B	BGR 41 space racks
BGR-TRIM45	BGR-TRIM45B	BGR 45 space racks

Part#	Cable Chase
BGR-CC-45FB	BGR front & back cable chase, 112mm width, fits 45 space racks
BGR-CC-41FB	BGR front & back cable chase, 112mm width, fits 41 space racks
BGR-CC-38FB	BGR front & back cable chase, 112mm width, fits 38 space racks
BGR-CC-38LT	BGR top cable chase, 112mm width, 965mm deep
BGR-CC-32LT	BGR top cable chase, 112mm width, 965mm deep
BGR-CC-27LT	BGR top cable chase, 112mm width, 965mm deep

Additional Options:

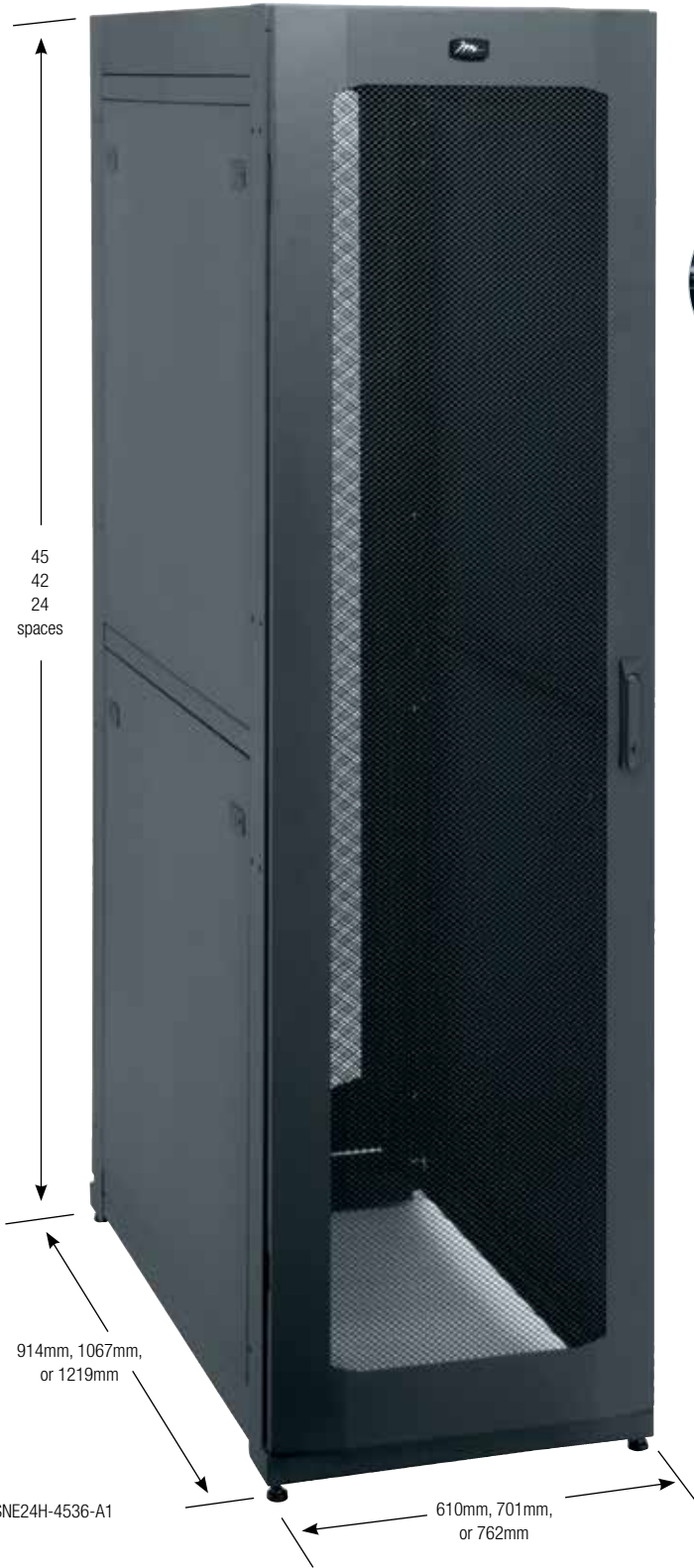

most advanced rack enclosure



The **SNE Series** is the most advanced security rack enclosure available.

- Four available configurations fit your system type, wiring needs, cooling requirements and rack location
- Thermal options built for unconditioned or conditioned environments with active or passive ventilation
- Adaptable equipment mounting threaded rail, cage nut rail or innovative adapter for both
- Raised-floor ready with seismic and standard riser bases
- Accepts Lever Lock™ system tool free cable management accessories, see pg. 206
- Versatile cable management and routing included
- Lockable, flush mount side panels
- Doors accommodate industry standard electronic locks
- Customized solutions available

Certifications

- Seismic Certified
- UL2416
- ROHS
- GREENGUARD

Market Solutions



Broadcast



Commercial
AV



Residential
AV



Security



Structured
Cabling



Education



International
Fan Available

Customize the SNE

- choose from all the sizes, thermal options & accessories to customize the SNE for your application
- visit middleatlantic.com/config

Power Solutions



100VAC





Product Information

Overall Height (w/ casters)	Hybrid or Digital	Ventilation	610mm Width			701mm Width			762mm Width		
			914mm Depth	1067mm Depth	1219mm Depth	914mm Depth	1067mm Depth	1219mm Depth	914mm Depth	1067mm Depth	1219mm Depth
1219mm (24 space)	Hybrid	top active	SNE24H-2436-A1	SNE24H-2442-A1	–	–	–	–	–	–	–
	Hybrid	rear active	SNE24H-2436-A2	SNE24H-2442-A2	–	–	–	–	–	–	–
	Digital	front to rear passive	SNE24D-2436-P1	SNE24D-2442-P1	–	–	–	–	–	–	–
2019mm (42 space)	Hybrid	top active	SNE24H-4236-A1	SNE24H-4242-A1	–	SNE27H-4236-A1	SNE27H-4242-A1	–	SNE30H-4236-A1	SNE30H-4242-A1	–
	Hybrid	rear active	SNE24H-4236-A2	SNE24H-4242-A2	–	SNE27H-4236-A2	SNE27H-4242-A2	–	SNE30H-4236-A2	SNE30H-4242-A2	–
	Digital	front to rear passive	SNE24D-4236-P1	SNE24D-4242-P1	SNE24D-4248-P1	SNE27D-4236-P1	SNE27D-4242-P1	SNE27D-4248-P1	SNE30D-4236-P1	SNE30DI4242-P1	SNE30D-4248-P1
	Digital	passive chimney	–	SNE24D-4242-P2	SNE24D-4248-P2	–	SNE27D-4242-P2	SNE27D-4248-P2	–	SNE30D-4242-P2	SNE30D-4248-P2
2152mm (45 space)	Hybrid	top active	SNE24H-4536-A1	SNE24H-4542-A1	–	SNE27H-4536-A1	SNE27H-4542-A1	–	SNE30H-4536-A1	SNE30H-4542-A1	–
	Hybrid	rear active	SNE24H-4536-A2	SNE24H-4542-A2	–	SNE27H-4536-A2	SNE27H-4542-A2	–	SNE30H-4536-A2	SNE30H-4542-A2	–
	Digital	front to rear passive	SNE24D-4536-P1	SNE24D-4542-P1	SNE24D-4548-P1	SNE27D-4536-P1	SNE27D-4542-P1	SNE27D-4548-P1	SNE30D-4536-P1	SNE30D-4542-P1	SNE30D-4548-P1
	Digital	passive chimney	–	SNE24D-4542-P2	SNE24D-4548-P2	–	SNE27D-4542-P2	SNE27D-4548-P2	–	SNE30D-4542-P2	SNE30D-4548-P2

Options

Please refer to the enclosure options section on pgs. 44-50 or visit our website for more info.

Options	Fits									
	Height	Width	914mm Deep	1067mm Deep	1219mm Deep	All Depths				
Cable Chase Lift-Off (Front & Back Only)	42 space	all				SNE-CC-42FB				
	45 space					SNE-CC-45FB				
Cable Chase Top Only	42 space	all	SNE-CC-36LT	SNE-CC-42LT	SNE-CC-48LT					
	45 space		SNE-CC-36LT	SNE-CC-42LT	SNE-CC-48LT					
Front-Air Dam/ Zero-U Panel Mount	42 space	701mm				SNE27-FAD-PM-42				
		762mm				SNE30-FAD-PM-42				
	45 space	701mm				SNE27-FAD-PM-45				
		762mm				SNE30-FAD-PM-45				
Bracket for Top Cable Pass-Through	all	all	SNE-TCB-36	SNE-TCB-42	SNE-TCB-48					
Lever Lock™ Mounting Bracket	all	all	LL-SNE-36BKT	LL-SNE-42BKT	LL-SNE-48BKT					
Lever Lock™ Accessories	all	all					Vertical Angle	Vertical Channel	Vertical 254mm Plate	Vertical DIN Rail
							LL-VA21	LL-VC21	LL-VP2110	LL-VDIN21
152mm Wide Vertical Wire Grid Lace	24 space	all				LACE-WB6-24				
	42 space					LACE-WB6-42				
	45 space					LACE-WB6-45				
Internal Vertical Cable Manager	24 space	all				SNE-IVCMF-24				
	42 space					SNE-IVCMF-42				
	45 space					SNE-IVCMF-45				
Seismic Anchoring Brackets	all	610mm				SNE24-Z4				
		701mm				SNE27-Z4				
		762mm				SNE30-Z4				



SNE30-FAD-PM-xx



SNE-TCB-xx



SNE-IVCMF-xx



SNE-CC-xxfb

See Website for additional Options	Riser Bases	Seismic Riser Bases	Raised Floor Angles
------------------------------------	-------------	---------------------	---------------------



multi-bay space saving rack



The **MRK Series** is designed for large-scale multi-bay jobs.

- Fully welded construction for strength
- Racks gang together when fully loaded
- Multiple lacing points and slotted rail brackets for cable management flexibility
- Standard front and rear adjustable 10-32 threaded rackrail with numbered spaces
- Racks with PRO suffix include two pairs of cage nut style rackrail
- Comes with standard configurable rear door; see pg. 226 for thermal management kits
- Preconfig version available see pg. 57
- Seismic certified up to 476 kgs.

Certifications

- Seismic Certification
- UL/ETL Listed
- RoHS
- GREENGUARD
- OSHPD

Market Solutions



Power Solutions



Customize the MRK

- choose from all the sizes, thermal options & accessories to customize the MRK for your application
- visit middleatlantic.com/config



Product Information

Part #	Racking Height	Overall Height	Useable Depth	Overall Depth	Side Panels	Commercial Caster Base (adds 24mm)	Fine Floor Caster Base (adds 24mm)	Add'l 10/32 Threaded Rackrail	Add'l Cage Nut Rackrail
MRK-2426	1067mm (24 space)	1222mm	610mm	673mm	SPN-24-267	CBS-MRK-26	CBS-MRK-26R	MV-RR24	PROMRK-RR24
MRK-2431	1067mm (24 space)	1222mm	737mm	800mm	SPN-24-312	CBS-MRK-31	CBS-MRK-31R	MV-RR24	PROMRK-RR24
MRK-3726	1645mm (37 space)	1800mm	610mm	673mm	SPN-37-267	CBS-MRK-26	CBS-MRK-26R	MV-RR37	PROMRK-RR37
MRK-3731	1645mm (37 space)	1800mm	737mm	800mm	SPN-37-312	CBS-MRK-31	CBS-MRK-31R	MV-RR37	PROMRK-RR37
MRK-4026	1778mm (40 space)	1934mm	610mm	673mm	SPN-40-267	CBS-MRK-26	CBS-MRK-26R	MV-RR40	PROMRK-RR40
MRK-4031	1778mm (40 space)	1934mm	737mm	800mm	SPN-40-312	CBS-MRK-31	CBS-MRK-31R	MV-RR40	PROMRK-RR40
MRK-4036*	1778mm (40 space)	1934mm	851mm	914mm	SPN-40-36	CBS-MRK-36	CBS-MRK-36R	MV-RR40	PROMRK-RR40
MRK-4042*	1778mm (40 space)	1934mm	1003mm	1067mm	SPN-40-423	CBS-MRK-42	-	MV-RR40	PROMRK-RR40
MRK-4426*	1956mm (44 space)	2111mm	610mm	673mm	SPN-44-267	CBS-MRK-26	CBS-MRK-26R	MV-RR44	PROMRK-RR44
MRK-4431*	1956mm (44 space)	2111mm	737mm	800mm	SPN-44-312	CBS-MRK-31	CBS-MRK-31R	MV-RR44	PROMRK-RR44
MRK-4431PRO**	1956mm (44 space)	2111mm	737mm	800mm	SPN-44-312	CBS-MRK-31	CBS-MRK-31R	MV-RR44	PROMRK-RR44
MRK-4436*	1956mm (44 space)	2111mm	851mm	914mm	SPN-44-36	CBS-MRK-36	CBS-MRK-36R	MV-RR44	PROMRK-RR44
MRK-4436PRO**	1956mm (44 space)	2111mm	851mm	914mm	SPN-44-36	CBS-MRK-36	CBS-MRK-36R	MV-RR44	PROMRK-RR44
MRK-4442*	1956mm (44 space)	2111mm	1003mm	1067mm	SPN-44-423	CBS-MRK-42	-	MV-RR44	PROMRK-RR44
MRK-4442PRO**	1956mm (44 space)	2111mm	1003mm	1067mm	SPN-44-423	CBS-MRK-42	-	MV-RR44	PROMRK-RR44

*available without rear door, suffix part # with 'LRD'

**configured with 2 pairs of cage nut style rackrail

Options

Please refer to the enclosure options section on pgs. 44-50 or visit our website for more info.

Fits Part #	Front Doors					Rear Doors			Solid Top	25% Open Area Top	64% Open Area Perf Top	Fan Tops			w/ integrated fan controllers
	Solid*	Plexi	25% Open Area Perf	64% Open Area Perf	Plexi Vented	64% Open Area Perf	79% Open Area Split Perf	w/ (4) 119mm Fans (380 CFM Total)				w/ (3) 152mm Fans (660 CFM Total)	w/ (1) 254mm Fan (550 CFM Total)		
MRK-2426	FD-24	PFD-24	VFD-24	LVFD-24	-	-	MW-CLVRD-24	MW-ST	MW-VT	MW-LVT	MW-4FT-380CFM	MW-6FT-660CFM	MW-10FT-550CFM	MW-4QFT-FC (220CFM) & MW-10FT-FC (550 CFM)	
MRK-2431	FD-24	PFD-24	VFD-24	LVFD-24	-	-	MW-CLVRD-24	MW-ST	MW-VT	MW-LVT	MW-4FT-380CFM	MW-6FT-660CFM	MW-10FT-550CFM	MW-4QFT-FC (220CFM) & MW-10FT-FC (550 CFM)	
MRK-3726	FD-37	PFD-37	VFD-37	LVFD-37	-	-	-	MW-ST	MW-VT	MW-LVT	MW-4FT-380CFM	MW-6FT-660CFM	MW-10FT-550CFM	MW-4QFT-FC (220CFM) & MW-10FT-FC (550 CFM)	
MRK-3731	FD-37	PFD-37	VFD-37	LVFD-37	-	-	-	MW-ST	MW-VT	MW-LVT	MW-4FT-380CFM	MW-6FT-660CFM	MW-10FT-550CFM	MW-4QFT-FC (220CFM) & MW-10FT-FC (550 CFM)	
MRK-4026	FD-40	PFD-40	VFD-40	LVFD-40	-	MW-LVRD-40	-	MW-ST	MW-VT	MW-LVT	MW-4FT-380CFM	MW-6FT-660CFM	MW-10FT-550CFM	MW-4QFT-FC (220CFM) & MW-10FT-FC (550 CFM)	
MRK-4031	FD-40	PFD-40	VFD-40	LVFD-40	-	MW-LVRD-40	-	MW-ST	MW-VT	MW-LVT	MW-4FT-380CFM	MW-6FT-660CFM	MW-10FT-550CFM	MW-4QFT-FC (220CFM) & MW-10FT-FC (550 CFM)	
MRK-4036	FD-40	PFD-40	VFD-40	LVFD-40	-	MW-LVRD-40	-	MW-ST	MW-VT	MW-LVT	MW-4FT-380CFM	MW-6FT-660CFM	MW-10FT-550CFM	MW-4QFT-FC (220CFM) & MW-10FT-FC (550 CFM)	
MRK-4042	FD-40	PFD-40	VFD-40	LVFD-40	-	MW-LVRD-40	-	MW-ST	MW-VT	MW-LVT	MW-4FT-380CFM	MW-6FT-660CFM	MW-10FT-550CFM	MW-4QFT-FC (220CFM) & MW-10FT-FC (550 CFM)	
MRK-4426	FD-44	PFD-44	VFD-44	LVFD-44	PVFD-44	MW-LVRD-44	MW-CLVRD-44	MW-ST	MW-VT	MW-LVT	MW-4FT-380CFM	MW-6FT-660CFM	MW-10FT-550CFM	MW-4QFT-FC (220CFM) & MW-10FT-FC (550 CFM)	
MRK-4431	FD-44	PFD-44	VFD-44	LVFD-44	PVFD-44	MW-LVRD-44	MW-CLVRD-44	MW-ST	MW-VT	MW-LVT	MW-4FT-380CFM	MW-6FT-660CFM	MW-10FT-550CFM	MW-4QFT-FC (220CFM) & MW-10FT-FC (550 CFM)	
MRK-4431PRO	FD-44	PFD-44	VFD-44	LVFD-44	PVFD-44	MW-LVRD-44	MW-CLVRD-44	MW-ST	MW-VT	MW-LVT	MW-4FT-380CFM	MW-6FT-660CFM	MW-10FT-550CFM	MW-4QFT-FC (220CFM) & MW-10FT-FC (550 CFM)	
MRK-4436	FD-44	PFD-44	VFD-44	LVFD-44	PVFD-44	MW-LVRD-44	MW-CLVRD-44	MW-ST	MW-VT	MW-LVT	MW-4FT-380CFM	MW-6FT-660CFM	MW-10FT-550CFM	MW-4QFT-FC (220CFM) & MW-10FT-FC (550 CFM)	
MRK-4436PRO	FD-44	PFD-44	VFD-44	LVFD-44	PVFD-44	MW-LVRD-44	MW-CLVRD-44	MW-ST	MW-VT	MW-LVT	MW-4FT-380CFM	MW-6FT-660CFM	MW-10FT-550CFM	MW-4QFT-FC (220CFM) & MW-10FT-FC (550 CFM)	
MRK-4442	FD-44	PFD-44	VFD-44	LVFD-44	PVFD-44	MW-LVRD-44	MW-CLVRD-44	MW-ST	MW-VT	MW-LVT	MW-4FT-380CFM	MW-6FT-660CFM	MW-10FT-550CFM	MW-4QFT-FC (220CFM) & MW-10FT-FC (550 CFM)	
MRK-4442PRO	FD-44	PFD-44	VFD-44	LVFD-44	PVFD-44	MW-LVRD-44	MW-CLVRD-44	MW-ST	MW-VT	MW-LVT	MW-4FT-380CFM	MW-6FT-660CFM	MW-10FT-550CFM	MW-4QFT-FC (220CFM) & MW-10FT-FC (550 CFM)	



Thermal Top Options pg. 46

- 240V Fans pg. 226
- Fan Controller pg. 130

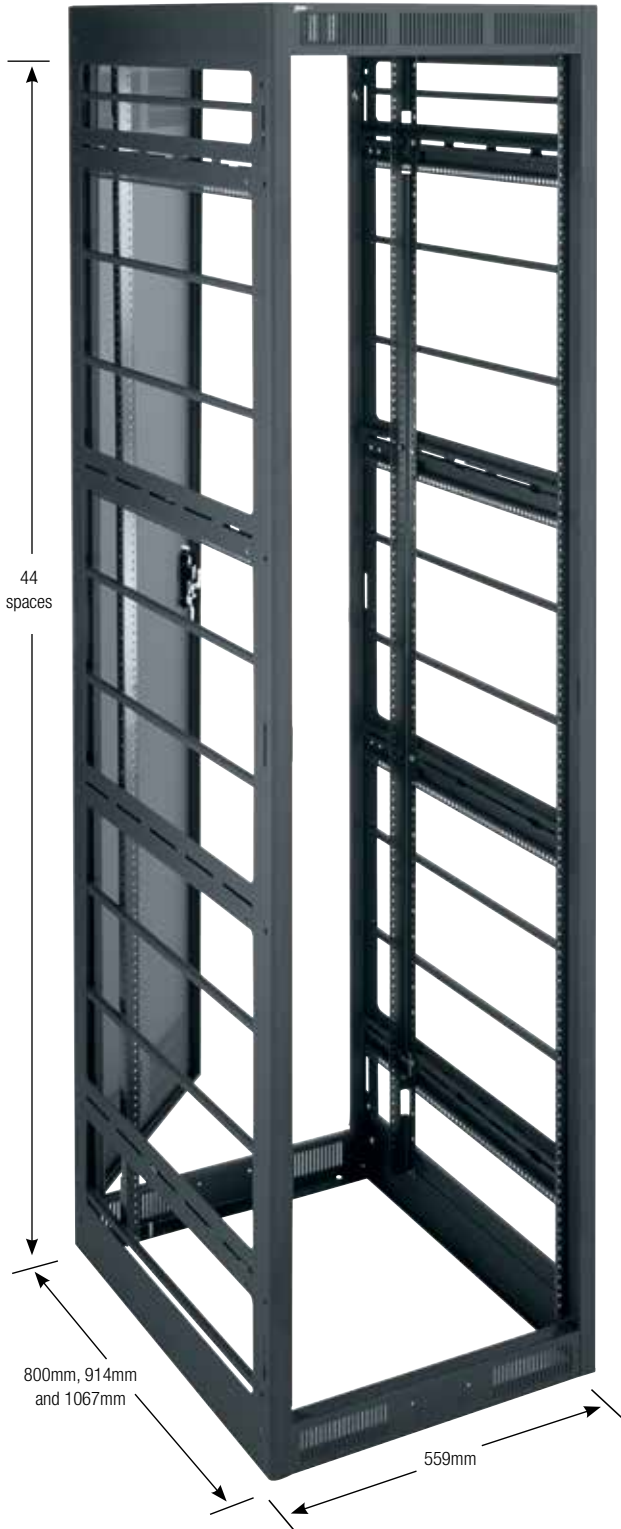

strong & narrow broadcast enclosure



The **VRK Series** was specifically designed for mounting video and AV equipment in a broadcast-standard 559mm wide enclosure.

- Built-in horizontal lacing bars are ideal for quick tie-and-slide lacing of video cable bundles
- Fully welded construction for strength
- Racks gang together when fully loaded
- Standard front and rear adjustable 10-32 threaded rackrail with numbered spaces
- Includes partially vented locking rear door (except LRD models)

Certifications

- Seismic Certification
- UL/ETL Listed
- RoHS
- GREENGUARD

Market Solutions



Power Solutions



VRK-44-31H



Product Information

Part #	Racking Height	Overall Height	Useable Depth	Overall Depth	Overall Width	Lockable Side Panels	Add'l 10/32 Threaded Rackrail	Add'l Cage Nut Rackrail	Z-rail Adaptor
VRK-44-31H*	1956mm (44 space)	2111mm	737mm	800mm	559mm	SPN-44-312	MV-RR44	PROMRK-RR44	MV-ZRA-44
VRK-44-36H*	1956mm (44 space)	2111mm	851mm	914mm	559mm	SPN-44-36	MV-RR44	PROMRK-RR44	MV-ZRA-44
VRK-44-42H*	1956mm (44 space)	2111mm	1003mm	1067mm	559mm	SPN-44-36	MV-RR44	PROMRK-RR44	MV-ZRA-44

*available without rear door, suffix part # 'LRD'



Get 20 Outlets

- PDT vertical power with up to 20 outlets to cover the entire rack. see pg. 176

Options

Please refer to the enclosure options section on pgs. 44-50 or visit our website for more info.

Rack Options: The options listed below are the most widely used accessories for this series of enclosure but is not inclusive of all available items. For additional options and/or more information on the items listed below reference the Enclosure Options section of the catalog.

Fits Part #	Front Doors					Rear Doors			Solid Top	64% Open Area Perf Top	Fan Tops		
	Solid	Plexi	25% Open Area Perf	64% Open Area Perf	Plexi Vented	64% Open Area Perf	79% Open Area Perf Split	w/ (4) 119mm Fans (380 CFM Total)			w/ (3) 152mm Fans (660 CFM Total)	w/ (1) 254mm Fan (550 CFM Total)	
VRK-44-31H	FD-44	PFD-44	VFD-44	LVFD-44	PVFD-44	MW-LVRD-44	MW-CLVRD-44	MW-ST	MW-LVT	MW-4FT-380CFM	MW-6FT-660CFM	MW-10FT-550CFM	
VRK-44-36H	FD-44	PFD-44	VFD-44	LVFD-44	PVFD-44	MW-LVRD-44	MW-CLVRD-44	MW-ST	MW-LVT	MW-4FT-380CFM	MW-6FT-660CFM	MW-10FT-550CFM	
VRK-44-42H	FD-44	PFD-44	VFD-44	LVFD-44	PVFD-44	MW-LVRD-44	MW-CLVRD-44	MW-ST	MW-LVT	MW-4FT-380CFM	MW-6FT-660CFM	MW-10FT-550CFM	



rugged, space-saving design



The **VMRK Series** adds extra height to take full advantage of taller spaces.

- Specify a VMRK to maximize your racking capacity, and where seismic certification and open or removable sides are required or preferred
- Fully welded construction for strength
- 54 spaces of racking height
- Racks gang together when fully loaded
- Multiple lacing points and slotted rail brackets for cable management flexibility
- Standard front and rear adjustable 10-32 threaded with numbered spaces
- Includes standard solid locking rear door (except LRD models)

Certifications

- Seismic Certification
- UL/ETL Listed
- RoHS
- GREENGUARD

Market Solutions



Broadcast



Commercial AV



Residential AV



Security



Structured Cabling



Education



International Fan Available

Power Solutions



100VAC





Product Information

Part #	Racking Height	Overall Height	Useable Depth	Overall Depth	Overall Width	Side Panels	Add'l 10/32 Threaded Z-rail
VMRK-54*	2400mm (54 space)	2556mm	737mm	800mm	559mm	SPN-54-312	VRR-54
VMRK-54-36*	2400mm (54 space)	2556mm	851mm	914mm	559mm	SPN-54-36	VRR-54

*available without rear door, suffix part # 'LRD'

Options

Please refer to the enclosure options section on pgs. 44-50 or visit our website for more info.

Rack Options: The options listed below are the most widely used accessories for this series of enclosure but is not inclusive of all available items. For additional options and/or more information on the items listed below reference the Enclosure Options section of the catalog.

Fits Part #	Front Doors			Rear Doors		Solid Top	64% open Area Perf Top	Fan Tops		
	Solid	Plexi	25% Open Area Perf	64% Open Area Perf	w/ (4) 119mm Fans (380 CFM Total)			w/ (3) 152mm Fans (660 CFM Total)	w/ (1) 254mm Fan (550 CFM Total)	
VMRK-54	FD-54	PFD-54	VFD-54	MW-LVRD-54	MW-ST	MW-LVT	MW-4FT-380CFM	MW-6FT-660CFM	MW-10FT-550CFM	
VMRK-54-36	FD-54	PFD-54	VFD-54	MW-LVRD-54	MW-ST	MW-LVT	MW-4FT-380CFM	MW-6FT-660CFM	MW-10FT-550CFM	

Note: Due to flipping hazard, there is no caster base available for this rack.



WMRK-4236
shown with optional front/rear doors

mixed-application multi-bay server



The **WMRK Series** is designed for deep equipment (servers & NVR) with large cable capacity.

- Comes standard with cage nut mounting rails and perforated doors and tops to meet server manufacturer warranty specifications
- Pre-configured models are available
- Fully welded construction for strength and stability
- 610mm overall width optimized for use on raised floors
- Racks gang together when fully loaded
- Includes two pair of adjustable cage nut rackrail and one pair of z-rail sidemount adaptors configured to accept servers and slide kits from all leading manufacturers
- Includes leveling feet and 100 qty of 6mm cage nuts and hardware
- Preconfig version available see pg. 57

Certifications

- Seismic Certification
- UL/ETL Listed
- RoHS
- GREENGUARD

Market Solutions



Broadcast



Commercial AV



Residential AV



Security



Structured Cabling



Education



International Fan Available

Customize the WMRK

- choose from all the sizes, thermal options & accessories to customize the WMRK for your application
- visit middleatlantic.com/config

Power Solutions



100VAC





Product Information

Part #	Racking Height	Overall Height	Useable Depth	Overall Depth	Overall Width	Lockable Side Panels	Caster Base	Plenum Base	Add'l Cage Nut Rackrail	Add'l Z-rail Adaptor
WMRK-2436	1067mm (24 space)	1227mm	851mm	914mm	610mm	SPN-24-36	CBS-WMRK-36	PBS-WMRK-36	PROWMRK-RR24	PROWMRK-ZRA-24
WMRK-2442	1067mm (24 space)	1227mm	1003mm	1067mm	610mm	SPN-24-42	CBS-WMRK-42	PBS-WMRK-42	PROWMRK-RR24	PROWMRK-ZRA-24
WMRK-4236	1867mm (42 space)	2027mm	851mm	914mm	610mm	SPN-42-36	CBS-WMRK-36	PBS-WMRK-36	PROWMRK-RR42	PROWMRK-ZRA-42
WMRK-4242	1867mm (42 space)	2027mm	1003mm	1067mm	610mm	SPN-42-42	CBS-WMRK-42	PBS-WMRK-42	PROWMRK-RR42	PROWMRK-ZRA-42
WMRK-4248	1867mm (42 space)	2027mm	1156mm	1219mm	610mm	SPN-42-48	CBS-WMRK-48	PBS-WMRK-48	PROWMRK-RR42	PROWMRK-ZRA-42
WMRK-4536	2000mm (45 space)	2161mm	851mm	914mm	610mm	SPN-45-36	CBS-WMRK-36	PBS-WMRK-36	PROWMRK-RR45	PROWMRK-ZRA-45
WMRK-4542	2000mm (45 space)	2161mm	1003mm	1067mm	610mm	SPN-45-42	CBS-WMRK-42	PBS-WMRK-42	PROWMRK-RR45	PROWMRK-ZRA-45
WMRK-4548	2000mm (45 space)	2161mm	1156mm	1219mm	610mm	SPN-45-48	CBS-WMRK-48	PBS-WMRK-48	PROWMRK-RR45	PROWMRK-ZRA-45



Thermal Top Options pg. 46
 • 240V Fans pg. 226
 • Fan Controller pg. 130

Options

Please refer to the enclosure options section on pgs. 44-50 or visit our website for more info.

Rack Options: The options listed below are the most widely used accessories for this series of enclosure but is not inclusive of all available items. For additional options and/or more information on the items listed below reference the Enclosure Options section of the catalog.

Fits Part #	Front Doors			Rear Doors*		64% Open Area Perf Top	Solid Top	Vented Top	Fan Tops		
	Solid	Plexi	70% Open Area Perf	Solid Split	79% Open Area Perf Split				w/ (3) 119mm Fans (285 CFM Total)	w/ (2) 152mm Fans (440 CFM Total)	w/ (1) 254mm Fan (550 CFM Total)
WMRK-2436	FD-WMRK-24	PFD-WMRK-24	LVFD-WMRK-24	CRD-WMRK-24	CLVRD-WMRK-24	ERK-LVT	ERK-ST	ERK-VT	ERK-4FT-285CFM	ERK-6FT-440CFM	ERK-10FT-550CFM
WMRK-2442	FD-WMRK-24	PFD-WMRK-24	LVFD-WMRK-24	CRD-WMRK-24	CLVRD-WMRK-24	ERK-LVT	ERK-ST	ERK-VT	ERK-4FT-285CFM	ERK-6FT-440CFM	ERK-10FT-550CFM
WMRK-4236	FD-WMRK-42	PFD-WMRK-42	LVFD-WMRK-42	CRD-WMRK-42	CLVRD-WMRK-42	ERK-LVT	ERK-ST	ERK-VT	ERK-4FT-285CFM	ERK-6FT-440CFM	ERK-10FT-550CFM
WMRK-4242	FD-WMRK-42	PFD-WMRK-42	LVFD-WMRK-42	CRD-WMRK-42	CLVRD-WMRK-42	ERK-LVT	ERK-ST	ERK-VT	ERK-4FT-285CFM	ERK-6FT-440CFM	ERK-10FT-550CFM
WMRK-4248	FD-WMRK-42	PFD-WMRK-42	LVFD-WMRK-42	CRD-WMRK-42	CLVRD-WMRK-42	ERK-LVT	ERK-ST	ERK-VT	ERK-4FT-285CFM	ERK-6FT-440CFM	ERK-10FT-550CFM
WMRK-4536	FD-WMRK-45	PFD-WMRK-45	LVFD-WMRK-45	CRD-WMRK-45	CLVRD-WMRK-45	ERK-LVT	ERK-ST	ERK-VT	ERK-4FT-285CFM	ERK-6FT-440CFM	ERK-10FT-550CFM
WMRK-4542	FD-WMRK-45	PFD-WMRK-45	LVFD-WMRK-45	CRD-WMRK-45	CLVRD-WMRK-45	ERK-LVT	ERK-ST	ERK-VT	ERK-4FT-285CFM	ERK-6FT-440CFM	ERK-10FT-550CFM
WMRK-4548	FD-WMRK-45	PFD-WMRK-45	LVFD-WMRK-45	CRD-WMRK-45	CLVRD-WMRK-45	ERK-LVT	ERK-ST	ERK-VT	ERK-4FT-285CFM	ERK-6FT-440CFM	ERK-10FT-550CFM

*High CFM Rear Door available



wide av multi-bay rack enclosure



The **WRK Series** is designed for multi-bay jobs that require large cable capacity and greater air-flow.

- Fully welded construction for strength
- 616mm overall width provides space for side cabling or cooling airflow
- Convenient lacing points and slotted rail brackets for cable management
- Standard front and rear adjustable 10-32 threaded rackrail with numbered spaces
- Extra-wide rackrail features cable pass-throughs to facilitate front-to-rear cabling
- Comes with standard configurable rear door see pg. 227 for thermal management kits (except LRD)

For stand-alone model, refer to pgs. 36-37.

Certifications

- Seismic Certification
- UL/ETL Listed
- RoHS
- GREENGUARD

Market Solutions



Broadcast



Commercial
AV



Residential
AV



Security



Structured
Cabling



Education



International
Fan Available

Power Solutions



100VAC



Thermal Top Options pg. 46

- 240V Fans pg. 226
- Fan Controller pg. 130



Product Information

Part #	Racking Height	Overall Height	Useable Depth	Overall Depth	Caster Base	Add'l 10/32 Threaded Rackrail	Add'l Cage Nut Rackrail	Lockable Side Panels
WRK-24-27	1067mm (24 space)	1222mm	654mm	702mm	CBS-WRK-27	WRK-RR24	PROWRK-RR24	SPN-24-267
WRK-24-32	1067mm (24 space)	1222mm	781mm	829mm	CBS-WRK-32	WRK-RR24	PROWRK-RR24	SPN-24-312
WRK-37-27	1645mm (37 space)	1800mm	654mm	702mm	CBS-WRK-27	WRK-RR37	PROWRK-RR37	SPN-37-267
WRK-37-32	1645mm (37 space)	1800mm	781mm	829mm	CBS-WRK-32	WRK-RR37	PROWRK-RR37	SPN-37-312
WRK-40-27	1778mm (40 space)	1934mm	654mm	702mm	CBS-WRK-27	WRK-RR40	PROWRK-RR40	SPN-40-267
WRK-40-32	1778mm (40 space)	1934mm	781mm	829mm	CBS-WRK-32	WRK-RR40	PROWRK-RR40	SPN-40-312
WRK-44-27*	1956mm (44 space)	2111mm	654mm	702mm	CBS-WRK-27	WRK-RR44	PROWRK-RR44	SPN-44-267
WRK-44-32*	1956mm (44 space)	2111mm	781mm	829mm	CBS-WRK-32	WRK-RR44	PROWRK-RR44	SPN-44-312

*available without rear door, suffix part # 'LRD'



Get Patented Protection

- See Series Protection™ power distribution – see pg. 170

Options

Please refer to the enclosure options section on pgs. 44-50 or visit our website for more info.

Rack Options: The options listed below are the most widely used accessories for this series of enclosure but is not inclusive of all available items. For additional options and/or more information on the items listed below reference the Enclosure Options section of the catalog.

Fits Part #	Front Doors					Rear Doors			Solid Top	Vented Top	Fan Tops		
	Solid*	Plexi	25% Open Area Perf	64% Open Area Perf	Plexi Vented	64% Open Area Perf	79% Perf Split Door	w/ (4) 119mm Fans (380 CFM Total)			w/ (3) 152mm Fans (660 CFM Total)	w/ (1) 254mm Fan (550 CFM Total)	
WRK-24-27	FD-24	PFD-24	VFD-24	LVFD-24	-	-	-	MW-ST	MW-LVT	MW-4FT-380CFM	MW-6FT-660CFM	MW-10FT-550CFM	
WRK-24-32	FD-24	PFD-24	VFD-24	LVFD-24	-	-	-	MW-ST	MW-LVT	MW-4FT-380CFM	MW-6FT-660CFM	MW-10FT-550CFM	
WRK-37-27	FD-37	PFD-37	VFD-37	LVFD-37	-	-	-	MW-ST	MW-LVT	MW-4FT-380CFM	MW-6FT-660CFM	MW-10FT-550CFM	
WRK-37-32	FD-37	PFD-37	VFD-37	LVFD-37	-	-	-	MW-ST	MW-LVT	MW-4FT-380CFM	MW-6FT-660CFM	MW-10FT-550CFM	
WRK-40-27	FD-40	PFD-40	VFD-40	LVFD-40	-	MW-LVRD-40	-	MW-ST	MW-LVT	MW-4FT-380CFM	MW-6FT-660CFM	MW-10FT-550CFM	
WRK-40-32	FD-40	PFD-40	VFD-40	LVFD-40	-	MW-LVRD-40	-	MW-ST	MW-LVT	MW-4FT-380CFM	MW-6FT-660CFM	MW-10FT-550CFM	
WRK-44-27	FD-44	PFD-44	VFD-44	LVFD-44	PVFD-44	MW-LVRD-44	MW-CLVRD-44	MW-ST	MW-LVT	MW-4FT-380CFM	MW-6FT-660CFM	MW-10FT-550CFM	
WRK-44-32	FD-44	PFD-44	VFD-44	LVFD-44	PVFD-44	MW-LVRD-44	MW-CLVRD-44	MW-ST	MW-LVT	MW-4FT-380CFM	MW-6FT-660CFM	MW-10FT-550CFM	



*see pg. 227 for fan panel options that fit knockouts



DRK19-44-31

wide networking rack enclosure

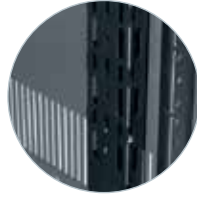

The **DRK Series** is designed to support high-density patching.

- DRK Series rack enclosures have a 762mm wide footprint for abundant internal cable space
- Pre-configured models are available
- Accommodates 483mm panel width equipment
- Use in network patching and other cable-heavy applications
- Fully welded construction for strength
- Racks gang together when fully loaded
- Includes pre-installed cable ducts with hinged steel doors and magnetic closures
- Cable duct is factory mounted in front, can also be mounted to rear
- Cable ducts accommodate copper and fiber cables equally well
- Standard front and rear adjustable 10-32 threaded or cage nut rackrail
- Includes 100 rack screws
- Includes partially vented locking-rear door
- Includes MW-10FT

Certifications

- Seismic Certification
- UL/ETL Listed
- RoHS
- GREENGUARD
- OSHPOD

Market Solutions



Broadcast



Commercial AV



Residential AV



Security



Structured Cabling



Education



International Fan Available

Power Solutions



100VAC





Product Information

Part #	Racking Height	Overall Height	Useable Depth	Overall Depth	Overall Width**	Side Panels	UL Listed Casterbase	Add'l 10/32 Threaded Rackrail	Add'l Cage Nut Rackrail
DRK19-44-31*	1956mm (44 space)	2120mm	616mm	800mm	762mm	SPN-44-312	CBS-DRK-31	DRK19-RR44	DRK19-RR44PRO
DRK19-44-31PRO*	1956mm (44 space)	2120mm	616mm	800mm	762mm	SPN-44-312	CBS-DRK-31	DRK19-RR44	DRK19-RR44PRO
DRK19-44-36*	1956mm (44 space)	2120mm	730mm	914mm	762mm	SPN-44-36	CBS-DRK-36	DRK19-RR44	DRK19-RR44PRO
DRK19-44-36PRO*	1956mm (44 space)	2120mm	730mm	914mm	762mm	SPN-44-36	CBS-DRK-36	DRK19-RR44	DRK19-RR44PRO
DRK19-44-42*	1956mm (44 space)	2120mm	899mm	1067mm	762mm	SPN-44-423	–	DRK19-RR44	DRK19-RR44PRO
DRK19-44-42PRO*	1956mm (44 space)	2120mm	899mm	1067mm	762mm	SPN-44-423	–	DRK19-RR44	DRK19-RR44PRO
DRK19-44-31K	1956mm (44 space)	2120mm	616mm	800mm	762mm	included	CBS-DRK-31	DRK19-RR44	DRK19-RR44PRO

*available without rear door, suffix part # 'LRD' **276mm wide models are available by special order, please inquire



• For additional cable management solutions – see pg. 214

Options

Please refer to the enclosure options section on pgs. 44-50 or visit our website for more info.

Rack Options: The options listed below are the most widely used accessories for this series of enclosure but is not inclusive of all available items. For additional options and/or more information on the items listed below reference the Enclosure Options section of the catalog.												
Fits Part #	Front Doors			Rear Doors				Solid Top	64% Open Area Perf Top	Fan Tops		
	Plexi	25% Open Area	Plexi Vented	Fully Vented	Solid Split	64% Open Area Perf	79% Open Area Split Perf			w/ (4) 119mm Fans (380 CFM Total)	w/ (3) 152mm Fans (660 CFM Total)	w/ (1) 254mm Fan (550 CFM Total)
DRK19-44-31	DPFD-44	DVFD-44	DPVFD-44	DFVRD-44	DCRD-44	DLVRD-44	DCLVRD-44	MW-ST	MW-LVT	MW-4FT-380CFM	MW-6FT-660CFM	MW-10FT-550CFM
DRK19-44-31PRO	DPFD-44	DVFD-44	DPVFD-44	DFVRD-44	DCRD-44	DLVRD-44	DCLVRD-44	MW-ST	MW-LVT	MW-4FT-380CFM	MW-6FT-660CFM	MW-10FT-550CFM
DRK19-44-36	DPFD-44	DVFD-44	DPVFD-44	DFVRD-44	DCRD-44	DLVRD-44	DCLVRD-44	MW-ST	MW-LVT	MW-4FT-380CFM	MW-6FT-660CFM	MW-10FT-550CFM
DRK19-44-36PRO	DPFD-44	DVFD-44	DPVFD-44	DFVRD-44	DCRD-44	DLVRD-44	DCLVRD-44	MW-ST	MW-LVT	MW-4FT-380CFM	MW-6FT-660CFM	MW-10FT-550CFM
DRK19-44-42	DPFD-44	DVFD-44	DPVFD-44	DFVRD-44	DCRD-44	DLVRD-44	DCLVRD-44	MW-ST	MW-LVT	MW-4FT-380CFM	MW-6FT-660CFM	MW-10FT-550CFM
DRK19-44-42PRO	DPFD-44	DVFD-44	DPVFD-44	DFVRD-44	DCRD-44	DLVRD-44	DCLVRD-44	MW-ST	MW-LVT	MW-4FT-380CFM	MW-6FT-660CFM	MW-10FT-550CFM
DRK19-44-31K	included	n/a	n/a	n/a	n/a	n/a	n/a	n/a	n/a	n/a	n/a	MW-10FT (incl.)

Duct for DRK Enclosures

Adds cable duct when rear cable management in a DRK installation is required.

- One or two ducts can be added in rear of rack
- Steel construction with black powder coat finish
- Sold in single pieces

Part #	Description
DRK-44DUCT	44 space cable duct



DRK-44DUCT



cost effective versatile multi-bay rack



The **Slim 5 Series** is designed for multiple AV applications and locations.

- Available in 12 standard sizes and any height from 8 to 43 spaces
- Ships ready to assemble
- Strong steel construction with wide open access for easy integration
- Lightweight, open design is easy to work with
- Knock down design allows for flat shipment via UPS
- Unique interlocking corner joint for exceptional strength and easy assembly
- Accepts optional removable steel side panels for security and to control airflow
- Accepts optional attractive thermolaminate top and side panels (19 colors)
- Top includes two laser knockout locations to mount cooling fans
- Standard front and rear fixed 10-32 threaded rackrail with marked spaces

Certifications

- UL/ETL Listed
- RoHS
- GREENGUARD

Market Solutions



Broadcast



Commercial AV



Residential AV



Security



Structured Cabling



Education



International Fan Available



- tops & side panels now available in 19 new finishes



Product Information

508mm Useable Depth Part #	660mm Useable Depth Part #	Racking Height	Overall Height
5-8	5-8-26	356mm (8 space)	451mm
5-14	5-14-26	622mm (14 space)	718mm
5-21	5-21-26	933mm (21 space)	1029mm
5-29	5-29-26	1289mm (29 space)	1384mm
5-37	5-37-26	1645mm (37 space)	1740mm
5-43	5-43-26	1911mm (43 space)	2007mm



- For a professional finished look try trim strips – see pg. 241

Options

Please refer to the enclosure options section on pgs. 44-50 or visit our website for more info.

Fits Part #	Solid Front Door	Plexi Front Door	Steel Side Panels, Pair	Thermolaminate Top/Side Panels**	Rear Access Panel	Adjustable "Split" Rear Rackrail	Cable Chase 76mm Wide*
5-8	D0-5-8	DOP-5-8	SP-5-8	–	RAP8	5AR8	5CC8
5-14	D0-5-14	DOP-5-14	SP-5-14	TSP-5-14xx	RAP14	5AR14	5CC14
5-21	D0-5-21	DOP-5-21	SP-5-21	TSP-5-21xx	RAP21	5AR21	5CC21
5-29	D0-5-29	DOP-5-29	SP-5-29	TSP-5-29xx	RAP29	5AR29	5CC29
5-37	D0-5-37	DOP-5-37	SP-5-37	TSP-5-37xx	RAP37	5AR37	5CC37
5-43	D0-5-43	DOP-5-43	SP-5-43	TSP-5-43xx	RAP43	5AR43	5CC43
5-8-26	D0-5-8	DOP-5-8	SP-5-8-26	–	RAP8	5AR8-26	5CC8-26
5-14-26	D0-5-14	DOP-5-14	SP-5-14-26	TSP-5-14-26xx	RAP14	5AR14-26	5CC14-26
5-21-26	D0-5-21	DOP-5-21	SP-5-21-26	TSP-5-21-26xx	RAP21	5AR21-26	5CC21-26
5-29-26	D0-5-29	DOP-5-29	SP-5-29-26	TSP-5-29-26xx	RAP29	5AR29-26	5CC29-26
5-37-26	D0-5-37	DOP-5-37	SP-5-37-26	TSP-5-37-26xx	RAP37	5AR37-26	5CC37-26
5-43-26	D0-5-43	DOP-5-43	SP-5-43-26	TSP-5-43-26xx	RAP43	5AR43-26	5CC43-26

*Custom width cable chases available, please call for details.

**Refer to FIN- part number to indicate desired thermolaminate color.

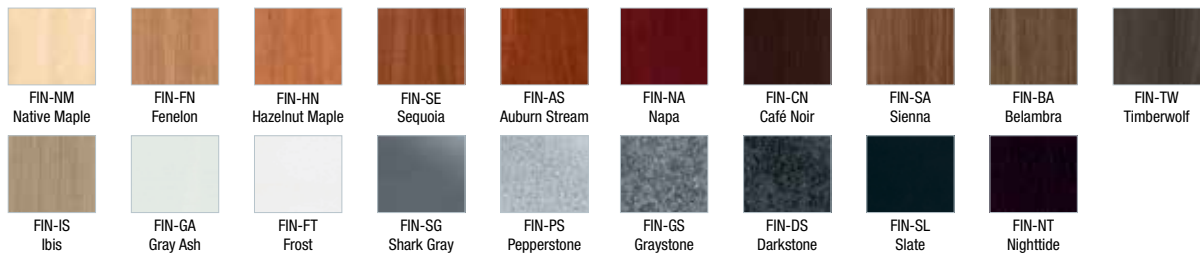

Part #	Description
5-BAVTRIM	black brushed vented trim panel, replaces top or bottom



5-BAVTRIM



stand-alone floor-standing enclosures

Stand-alone racks are designed to house all types of electronic systems in smaller installations where one rack is sufficient for the need, or for where multiple racks are used but are not standing together in a row.

Racks in this section are floor-standing and have solid sides for strength, security, and to control cooling airflow. For most models, a variety of options are available, including front and rear doors, solid, vented and fan tops, and caster and riser bases.



Stand-alone racks range in capacity from 18 to 45 rack spaces at multiple depths.

BGR-SA Series	32 - 33
BGR Series Presentation Enclosure	34 - 35
WRK-SA Series	36 - 37
WRK-24MDK Series	38 - 39
ERK Series	42 - 43
ERK-KD Series	44 - 50
Options	51
SRB Series Riser Bases	52 - 53
Raised Floor Enclosure Support System™	54 - 55
Configured Enclosure Systems	56 - 57



highest level
of space efficiency



The **BGR-SA Series** has the highest level of space efficiency, strength and flexibility.



- Designed to accommodate evolving AV systems
- Breakthrough design provides high strength without extra weight
- Wide open top and bottom offer many cabling and cooling options
- Fixed solid side for security and to control airflow
- Standard front and rear adjustable 10-32 threaded rackrail with numbered spaces
- Includes standard vented rear door that accepts optional fans (Except LRD models)
- Accepts Lever Lock™ system tool free cable management accessories (see pg. 206)
- Accepts extender bay to add 76mm of useable depth to the front or rear at any time
- Accepts brush grommet rear door kit for a large cable passage without fishing

Certifications

- Seismic Certification
- UL/ETL Listed
- RoHS
- GREENGUARD
- OSHPOD

Market Solutions



Power Solutions



100VAC – 2240VAC | 50/60Hz Compatible



Product Information

Part #*	Racking Height	Overall Height	Overall Depth	Useable Depth	Add'l 10/32 Threaded Rackrail (Pair)	Accent Trim (Silver)
BGR-19SA-27	845mm (19 space)	949mm	686mm	619mm	BGR-RR19	BGR-TRIM19
BGR-25SA-27	1111mm (25 space)	1216mm	686mm	619mm	BGR-RR25	BGR-TRIM25
BGR-25SA-32	1111mm (25 space)	1216mm	813mm	746mm	BGR-RR25	BGR-TRIM25
BGR-38SA-27	1689mm (38 space)	1794mm	686mm	619mm	BGR-RR38	BGR-TRIM38
BGR-38SA-32	1689mm (38 space)	1794mm	813mm	746mm	BGR-RR38	BGR-TRIM38
BGR-41SA-27	1822mm (41 space)	1927mm	686mm	619mm	BGR-RR41	BGR-TRIM41
BGR-41SA-32	1822mm (41 space)	1927mm	813mm	746mm	BGR-RR41	BGR-TRIM41
BGR-45SA-27	2000mm (45 space)	2105mm	686mm	619mm	BGR-RR45	BGR-TRIM45
BGR-45SA-32	2000mm (45 space)	2105mm	813mm	746mm	BGR-RR45	BGR-TRIM45

*available without rear door, suffix part # 'LRD'. *accent trim also available in black, suffix part # 'B'

Options

Please refer to the enclosure options section on pgs. 44-50 or visit our website for more info.

Fits Part #	Front Doors					Rear Doors		Solid Top	Top Rail Reducer	Vented Top	Duct-Cool™ Adapter Top	Fan Tops			
	Solid	Plexi	Vented	Curved Door Vented	Curved Door Plexi	Cable Entry Rear Door**	15,63m³/min					7,82m³/min	15,63m³/min with Controller	7,82m³/min with Controller	
BGR-19SA-27	BFD-19	BPDF-19	BVFD-19	VFD-19A	PFD-19A	BGR-RDC19	-	-	-	-	-	-	-	-	-
BGR-25SA-27	BFD-25	BPDF-25	BVFD-25	VFD-25A	PFD-25A	BGR-RDC25	-	-	-	-	-	-	-	-	-
BGR-25SA-32	BFD-25	BPDF-25	BVFD-25	VFD-25A	PFD-25A	BGR-RDC25	-	-	-	-	-	-	-	-	-
BGR-38SA-27	BFD-38	BPDF-38	BVFD-38	VFD-38A	PFD-38A	BGR-RDC38	BGR-STP9	BGR-TRR9	BGR-LVT9	BGR-DT9	IBGR-552FT	IBGR-276FT	IBGR-552FT-FC	IBGR-276FT-FC	
BGR-38SA-32	BFD-38	BPDF-38	BVFD-38	VFD-38A	PFD-38A	BGR-RDC38	BGR-STP9	BGR-TRR9	BGR-LVT9	BGR-DT9	IBGR-552FT	IBGR-276FT	IBGR-552FT-FC	IBGR-276FT-FC	
BGR-41SA-27	BFD-41	BPDF-41	BVFD-41	VFD-41A	PFD-41A	BGR-RDC41	BGR-STP9	BGR-TRR9	BGR-LVT9	BGR-DT9	IBGR-552FT	IBGR-276FT	IBGR-552FT-FC	IBGR-276FT-FC	
BGR-41SA-32	BFD-41	BPDF-41	BVFD-41	VFD-41A	PFD-41A	BGR-RDC41	BGR-STP9	BGR-TRR9	BGR-LVT9	BGR-DT9	IBGR-552FT	IBGR-276FT	IBGR-552FT-FC	IBGR-276FT-FC	
BGR-45SA-27	BFD-45	BPDF-45	BVFD-45	VFD-45A	PFD-45A	BGR-RDC45	BGR-STP9	BGR-TRR9	BGR-LVT9	BGR-DT9	IBGR-552FT	IBGR-276FT	IBGR-552FT-FC	IBGR-276FT-FC	
BGR-45SA-32	BFD-45	BPDF-45	BVFD-45	VFD-45A	PFD-45A	BGR-RDC45	BGR-STP9	BGR-TRR9	BGR-LVT9	BGR-DT9	IBGR-552FT	IBGR-276FT	IBGR-552FT-FC	IBGR-276FT-FC	
BGR-4532	BFD-45	BPDF-45	BVFD-45	VFD-45A	PFD-45A	BGR-RDC45	BGR-STP9	BGR-TRR9	BGR-LVT9		IBGR-552FT	IBGR-276FT	IBGR-552FT-FC	IBGR-276FT-FC	
BGR-4538	BFD-45	BPDF-45	BVFD-45	VFD-45A	PFD-45A	BGR-RDC45	BGR-STP9	BGR-TRR9	BGR-LVT9		IBGR-552FT	IBGR-276FT	IBGR-552FT-FC	IBGR-276FT-FC	

*All fan tops come with blank panels to close top of rack. **Only compatible with 'LRD' models.

Front Trim Kit Part # (Silver)	Front Trim Kit Part # (Black)	Fits
BGR-TRIM19	BGR-TRIM19B	BGR 19 space racks
BGR-TRIM25	BGR-TRIM25B	BGR 25 space racks
BGR-TRIM38	BGR-TRIM38B	BGR 38 space racks
BGR-TRIM41	BGR-TRIM41B	BGR 41 space racks
BGR-TRIM45	BGR-TRIM45B	BGR 45 space racks

Part#	Cable Chase
BGR-CC-45FB	BGR front & back cable chase, 112mm width, fits 45 space racks
BGR-CC-41FB	BGR front & back cable chase, 112mm width, fits 41 space racks
BGR-CC-38FB	BGR front & back cable chase, 112mm width, fits 38 space racks
BGR-CC-38LT	BGR top cable chase, 112mm width, 965mm deep
BGR-CC-32LT	BGR top cable chase, 112mm width, 965mm deep
BGR-CC-27LT	BGR top cable chase, 112mm width, 965mm deep

Additional Options:

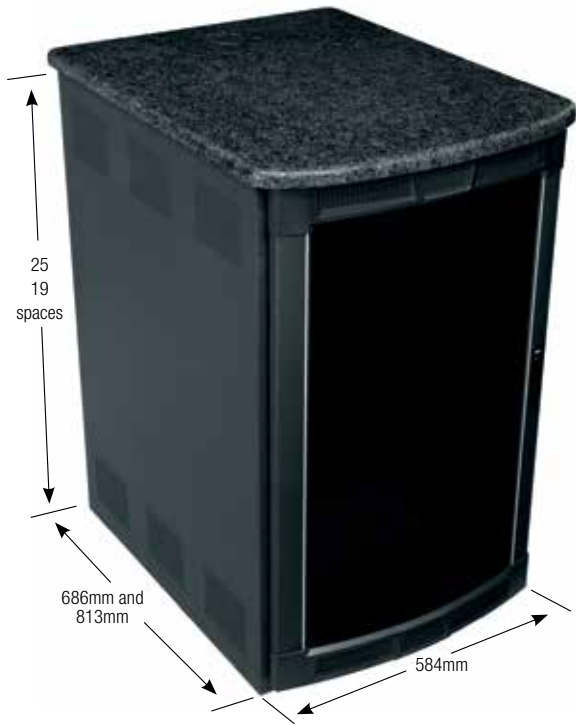

BGR-19SA27-MDK-DS

rugged and reliable



The **BGR-MDK Series** combines furniture elegance with a robust rolling steel enclosure. Attractive thermolaminate top can accommodate video monitors.

- Breakthrough design provides high strength without extra weight
- Curved plexi front door, cable entry rear door, and thermolaminate top
- Cable management rear door
- Efficient mounting Lever Lock™ system compatible (see pg. 206)
- Fixed solid sides for security and to control airflow
- Standard front and rear adjustable 10-32 threaded rackrail with numbered spaces
- Includes casters

Certifications

- Seismic Certification
- UL/ETL Listed
- RoHS
- GREENGUARD
- OSHPOD

Market Solutions



Broadcast



Commercial AV



Residential AV



Security



Structured Cabling



Education



International Fan Available



Product Information

Part #	Overall Height	Racking Height	Overall Depth	Useable Depth
BGR-19SA27MDK-XX*	1003mm	845mm (19 rackspace)	797mm	619mm
BGR-25SA27MDK-XX*	1270mm	1111mm (25 rackspace)	797mm	619mm
BGR-25SA32MDK-XX*	1270mm	1111mm (25 rackspace)	797mm	746mm

* XX indicates choice of color

Top Finishes

For full selection of finishes, please refer to pg. 249



FIN-NM
native maple



FIN-AS
auburn stream



FIN-CN
café noir

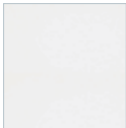

FIN-FT
frost



FIN-NT
nighttide

Additional Options:



Monitor Mounts
see pg.144



Lever Lock™
see pg. 206



wide av stand-alone rack



The **WRK-SA Series** is designed for single-rack jobs that require large cable capacity and greater air-flow.

- Fully welded construction for strength
- 616mm overall width provides space for side cabling or cooling airflow
- Convenient lacing points and slotted rail brackets for cable management
- Standard front and rear adjustable 10-32 threaded rackrail with numbered spaces
- Extra-wide rackrail features cable pass-throughs to facilitate front-to-rear cabling
- Comes with standard configurable rear door see pg. 227 for thermal management kits (except LRD)

Certifications

- Seismic Certification
- UL/ETL Listed
- RoHS
- GREENGUARD

Market Solutions



Broadcast



Commercial AV



Residential AV



Security



Structured Cabling



Education



International Fan Available



WRK-44SA-27



- Thermal Top Options pg. 46
- 240V Fans pg. 226
 - Fan Controller pg. 130

Power Solutions



100VAC





Product Information

Part #*	Racking Height	Overall Height	Useable Depth	Overall Depth	Caster Base	Add'l 10/32 Threaded Rackrail	Add'l Cage Nut Rackrail
WRK-24SA-27	1067mm (24 space)	1222mm	654mm	702mm	CBS-WRK-27	WRK-RR24	PROWRK-RR24
WRK-24SA-32	1067mm (24 space)	1222mm	781mm	829mm	CBS-WRK-32	WRK-RR24	PROWRK-RR24
WRK-37SA-27	1645mm (37 space)	1800mm	654mm	702mm	CBS-WRK-27	WRK-RR37	PROWRK-RR37
WRK-37SA-32	1645mm (37 space)	1800mm	781mm	829mm	CBS-WRK-32	WRK-RR37	PROWRK-RR37
WRK-40SA-27	1778mm (40 space)	1934mm	654mm	702mm	CBS-WRK-27	WRK-RR40	PROWRK-RR40
WRK-40SA-32	1778mm (40 space)	1934mm	781mm	829mm	CBS-WRK-32	WRK-RR40	PROWRK-RR40
WRK-44SA-27*	1956mm (44 space)	2111mm	654mm	702mm	CBS-WRK-27	WRK-RR44	PROWRK-RR44
WRK-44SA-32*	1956mm (44 space)	2111mm	781mm	829mm	CBS-WRK-32	WRK-RR44	PROWRK-RR44

*available without rear door, suffix part # 'LRD'



Installation Helper

- Organize and route cables
- Vertical cable management pg. 214
- Horizontal cable management pg. 210

Options

Please refer to the enclosure options section on pgs. 44-50 or visit our website for more info.

Rack Options: The options listed below are the most widely used accessories for this series of enclosure but is not inclusive of all available items. For additional options and/or more information on the items listed below reference the Enclosure Options section of the catalog.														
Fits Part #	Front Doors					Rear Doors			Solid Top	Vented Top	Duct-Cool™ Adapter Top	Fan Tops		
	Solid	Plexi	25% Open Area Perf	64% Open Area Perf	Plexi Vented	64% Open Area Perf	79% Perf Split Door	w/ (4) 119mm Fans (380 CFM Total)				w/ (3) 152mm Fans (660 CFM Total)	w/ (1) 254mm Fan (550 CFM Total)	
WRK-24SA-27	FD-24	PFD-24	VFD-24	LVFD-24	-	-	-	MW-ST	MW-LVT	MW-DT	MW-4FT-380CFM	MW-6FT-660CFM	MW-10FT-550CFM	
WRK-24SA-32	FD-24	PFD-24	VFD-24	LVFD-24	-	-	-	MW-ST	MW-LVT	MW-DT	MW-4FT-380CFM	MW-6FT-660CFM	MW-10FT-550CFM	
WRK-37SA-27	FD-37	PFD-37	VFD-37	LVFD-37	-	-	-	MW-ST	MW-LVT	MW-DT	MW-4FT-380CFM	MW-6FT-660CFM	MW-10FT-550CFM	
WRK-37SA-32	FD-37	PFD-37	VFD-37	LVFD-37	-	-	-	MW-ST	MW-LVT	MW-DT	MW-4FT-380CFM	MW-6FT-660CFM	MW-10FT-550CFM	
WRK-40SA-27	FD-40	PFD-40	VFD-40	LVFD-40	-	MW-LVRD-40	-	MW-ST	MW-LVT	MW-DT	MW-4FT-380CFM	MW-6FT-660CFM	MW-10FT-550CFM	
WRK-40SA-32	FD-40	PFD-40	VFD-40	LVFD-40	-	MW-LVRD-40	-	MW-ST	MW-LVT	MW-DT	MW-4FT-380CFM	MW-6FT-660CFM	MW-10FT-550CFM	
WRK-44SA-27	FD-44	PFD-44	VFD-44	LVFD-44	PVFD-44	MW-LVRD-44	MW-CLVRD-44	MW-ST	MW-LVT	MW-DT	MW-4FT-380CFM	MW-6FT-660CFM	MW-10FT-550CFM	
WRK-44SA-32	FD-44	PFD-44	VFD-44	LVFD-44	PVFD-44	MW-LVRD-44	MW-CLVRD-44	MW-ST	MW-LVT	MW-DT	MW-4FT-380CFM	MW-6FT-660CFM	MW-10FT-550CFM	



presentation rack enclosure



The **WRK-24MDK Series** is designed for substantial cable and thermal needs combined with furniture elegance.

- Fully welded construction for strength
- 616mm overall width provides space for side cabling or cooling airflow
- Convenient lacing points and slotted rail brackets for cable management
- Standard front and rear adjustable 10-32 threaded rackrail with numbered spaces
- Extra-wide rackrail features cable pass-throughs to facilitate front-to-rear cabling
- Includes latching front plexi door and latching vented rear door
- Includes skirted wheel base
- Includes attractive laminate top that can accommodate video monitors

Certifications

- Seismic Certification
- UL/ETL Listed
- RoHS
- GREENGUARD

Market Solutions



Broadcast



Commercial
AV



Residential
AV



Security



Structured
Cabling



Education



International
Fan Available



Product Information

Part #	Description
WRK-24MDK	1067mm (24 space) x 826mm deep presentation enclosure system
MMB1X1C*	single LCD mount, articulating, black finish

*12 kg. weight capacity



Vertical Power

- PDT vertical power with up to 20 outlets to cover the entire rack. see pg. 176

Additional Options:



Monitor Mounts
see pg. 144



cost effective stand-alone rack



The **ERK Series** stand-alone rack has multi-bay capabilities for thermal management control, future growth or other purposes.

- Fully welded construction for strength
- Enclosure sides include top and bottom venting
- Convenient lacing points and slotted rail brackets for cable management
- Standard front adjustable 10-32 threaded rackrail with numbered spaces
- Comes with standard configurable rear door
- Ready-to-assemble knock down models are also available
- Preconfig version available see pg. 56

Certifications

- Seismic Certification
- UL2416
- RoHS
- GREENGUARD

Market Solutions



Broadcast



Commercial
AV



Residential
AV



Security



Structured
Cabling



Education



International
Fan Available

Power Solutions



100VAC



Customize the ERK

- choose from all the sizes, thermal options & accessories to customize the ERK for your application
- visit middleatlantic.com/config





Product Information

Part #•	Racking Height	Overall Height	Useable Depth	Overall Depth	Skirted WheelBase (adds 95mm)	Additional Rackrail
ERK-1820	800mm (18 space)	905mm	470mm	508mm	CBS-ERK-20	ERK-RR18
ERK-1825	800mm (18 space)	905mm	597mm	635mm	CBS-ERK-25	ERK-RR18
ERK-1828	800mm (18 space)	905mm	673mm	711mm	CBS-ERK-28	ERK-RR18
ERK-2120	933mm (21 space)	1038mm	470mm	508mm	CBS-ERK-20	ERK-RR21
ERK-2125	933mm (21 space)	1038mm	597mm	635mm	CBS-ERK-25	ERK-RR21
ERK-2128	933mm (21 space)	1038mm	673mm	711mm	CBS-ERK-28	ERK-RR21
ERK-2720	1200mm (27 space)	1305mm	470mm	508mm	CBS-ERK-20	ERK-RR27
ERK-2725	1200mm (27 space)	1305mm	597mm	635mm	CBS-ERK-25	ERK-RR27
ERK-2728	1200mm (27 space)	1305mm	673mm	711mm	CBS-ERK-28	ERK-RR27
ERK-3520	1556mm (35 space)	1661mm	470mm	508mm	CBS-ERK-20	ERK-RR35
ERK-3525	1556mm (35 space)	1661mm	597mm	635mm	CBS-ERK-25	ERK-RR35
ERK-3528	1556mm (35 space)	1661mm	673mm	711mm	CBS-ERK-28	ERK-RR35
ERK-4020	1778mm (40 space)	1883mm	470mm	508mm	CBS-ERK-20	ERK-RR40
ERK-4025	1778mm (40 space)	1883mm	597mm	635mm	CBS-ERK-25	ERK-RR40
ERK-4028	1778mm (40 space)	1883mm	673mm	711mm	CBS-ERK-28	ERK-RR40
ERK-4420	1956mm (44 space)	2061mm	470mm	508mm	CBS-ERK-20	ERK-RR44
ERK-4425	1956mm (44 space)	2061mm	597mm	635mm	CBS-ERK-25	ERK-RR44
ERK-4428	1956mm (44 space)	2061mm	673mm	711mm	CBS-ERK-28	ERK-RR44

•available without rear door, suffix part # 'LRD'



Thermal Top Options pg. 46
 • 240V Fans pg. 226
 • Fan Controller pg. 130

Options

Please refer to the enclosure options section on pgs. 44-50 or visit our website for more info.

Fits Part #	Front Doors				Rear Door		64% Open Area Perf Top	Solid Top	Vented Top	Fan Tops		
	Solid*	Plexi	25% Open Area Perf	64% Open Area Perf	Top & Bottom Slot Vented	Cable Entry				w/ (3) 119mm Fans (285 CFM Total)	w/ (2) 152mm Fans (440 CFM Total)	w/ (1) 254mm Fan (550 CFM Total)
ERK-1820	FD-18	PFD-18	VFD-18	LVFD-18	ERK-VRD-18	ERK-RDC18	-	-	-	-	-	-
ERK-1825	FD-18	PFD-18	VFD-18	LVFD-18	ERK-VRD-18	ERK-RDC18	-	-	-	-	-	-
ERK-1828	FD-18	PFD-18	VFD-18	LVFD-18	ERK-VRD-18	ERK-RDC18	-	-	-	-	-	-
ERK-2120	FD-21	PFD-21	VFD-21	LVFD-21	ERK-VRD-21	ERK-RDC21	-	-	-	-	-	-
ERK-2125	FD-21	PFD-21	VFD-21	LVFD-21	ERK-VRD-21	ERK-RDC21	-	-	-	-	-	-
ERK-2128	FD-21	PFD-21	VFD-21	LVFD-21	ERK-VRD-21	ERK-RDC21	-	-	-	-	-	-
ERK-2720	FD-27	PFD-27	VFD-27	-	ERK-VRD-27	ERK-RDC27	-	-	-	-	-	-
ERK-2725	FD-27	PFD-27	VFD-27	-	ERK-VRD-27	ERK-RDC27	-	-	-	-	-	-
ERK-2728	FD-27	PFD-27	VFD-27	-	ERK-VRD-27	ERK-RDC27	-	-	-	-	-	-
ERK-3520	FD-35	PFD-35	VFD-35	LVFD-35	ERK-VRD-35	ERK-RDC35	ERK-LVT	ERK-ST	ERK-VT	ERK-4FT-285CFM	ERK-6FT-440CFM	ERK-10FT-550CFM
ERK-3525	FD-35	PFD-35	VFD-35	LVFD-35	ERK-VRD-35	ERK-RDC35	ERK-LVT	ERK-ST	ERK-VT	ERK-4FT-285CFM	ERK-6FT-440CFM	ERK-10FT-550CFM
ERK-3528	FD-35	PFD-35	VFD-35	LVFD-35	ERK-VRD-35	ERK-RDC35	ERK-LVT	ERK-ST	ERK-VT	ERK-4FT-285CFM	ERK-6FT-440CFM	ERK-10FT-550CFM
ERK-4020	FD-40	PFD-40	VFD-40	LVFD-40	ERK-VRD-40	ERK-RDC40	ERK-LVT	ERK-ST	ERK-VT	ERK-4FT-285CFM	ERK-6FT-440CFM	ERK-10FT-550CFM
ERK-4025	FD-40	PFD-40	VFD-40	LVFD-40	ERK-VRD-40	ERK-RDC40	ERK-LVT	ERK-ST	ERK-VT	ERK-4FT-285CFM	ERK-6FT-440CFM	ERK-10FT-550CFM
ERK-4028	FD-40	PFD-40	VFD-40	LVFD-40	ERK-VRD-40	ERK-RDC40	ERK-LVT	ERK-ST	ERK-VT	ERK-4FT-285CFM	ERK-6FT-440CFM	ERK-10FT-550CFM
ERK-4420	FD-44	PFD-44	VFD-44	LVFD-44	ERK-VRD-44	ERK-RDC44	ERK-LVT	ERK-ST	ERK-VT	ERK-4FT-285CFM	ERK-6FT-440CFM	ERK-10FT-550CFM
ERK-4425	FD-44	PFD-44	VFD-44	LVFD-44	ERK-VRD-44	ERK-RDC44	ERK-LVT	ERK-ST	ERK-VT	ERK-4FT-285CFM	ERK-6FT-440CFM	ERK-10FT-550CFM
ERK-4428	FD-44	PFD-44	VFD-44	LVFD-44	ERK-VRD-44	ERK-RDC44	ERK-LVT	ERK-ST	ERK-VT	ERK-4FT-285CFM	ERK-6FT-440CFM	ERK-10FT-550CFM

Additional Options	Part #	Description	Additional Depth	Racking Height	Finish
	ERK-44-F-EXT3	front extender	76mm	44 space	black powder coat
	ERK-44-R-EXT3	rear extender	76mm	44 space	black powder coat
	ERK-40-F-EXT3	front extender	76mm	40 space	black powder coat
	ERK-40-R-EXT3	rear extender	76mm	40 space	black powder coat
	PET-K-RD	pet kit, for rear door to rack bonding			
	PET-K-RDC	pet kit, rear cable door to rack			
PET-K-EXT	pet kit, door extender to rack				



knock down & cost effective



The **ERK-KD Series** stand-alone rack with multi-bay capabilities in a knock-down version for ease of transportation.

- Knock down design allows for flat shipment
- Electrical knockouts on rear plates
- Laser-cut 3mm thick internal steel braces for strength
- Standard front adjustable 10-32 threaded rackrail with numbered spaces
- Open, configurable top knockouts



Certifications

- UL2416
- RoHS
- GREENGUARD

Market Solutions



Broadcast



Commercial
AV



Residential
AV



Security



Structured
Cabling



Education



International
Fan Available

Power Solutions



100VAC





Product Information

Part #*	Racking Height	Overall Height	Useable Depth	Overall Depth	Skirted WheelBase (adds 95mm)	Additional Rackrail
ERK-1025KD*	445mm (10 space)	549mm	597mm	635mm	CBS-ERK-25	ERK-RR10
ERK-1825KD*	800mm (18 space)	905mm	597mm	635mm	CBS-ERK-25	ERK-RR18
ERK-2125KD*	933mm (21 space)	1038mm	597mm	635mm	CBS-ERK-25	ERK-RR21
ERK-3525KD*	1556mm (35 space)	1661mm	597mm	635mm	CBS-ERK-25	ERK-RR235
ERK-4425KD*	1956mm (44 space)	2061mm	597mm	635mm	CBS-ERK-25	ERK-RR25

*available without rear door, suffix part # 'LRD'

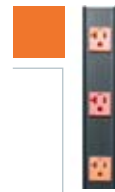

Get 20 Outlets

- PDT vertical power with up to 20 outlets to cover the entire rack. see pg. 176

Options

Please refer to the enclosure options section on pgs. 44-50 or visit our website for more info.

Fits Part #	Front Doors				Rear Door		64% Open Area Perf Top	Vented Top	Fan Tops		
	Solid	Plexi	25% Open Area Perf	64% Open Area Perf	Top & Bottom Slot Vented	Cable Entry			w/ (3) 119mm Fans (285 CFM Total)	w/ (2) 152mm Fans (440 CFM Total)	w/ (1) 254mm Fan (550 CFM Total)
ERK-1025KD	FD-10	PFD-10	VFD-10	LVFD-10	ERK-VRD-10	--	--	--	--	--	--
ERK-1825KD	FD-18	PFD-18	VFD-18	LVFD-18	ERK-VRD-18	ERK-RDC18	--	--	--	--	--
ERK-2125KD	FD-21	PFD-21	VFD-21	LVFD-21	ERK-VRD-21	ERK-RDC21	--	--	--	--	--
ERK-3525KD	FD-35	PFD-35	VFD-35	LVFD-35	ERK-VRD-35	ERK-RDC35	ERK-LVT	ERK-VT	ERK-4FT-285CFM	ERK-6FT-440CFM	ERK-10FT-550CFM
ERK-4425KD	FD-44	PFD-44	VFD-44	LVFD-44	ERK-VRD-44	ERK-RDC44	ERK-LVT	ERK-VT	ERK-4FT-285CFM	ERK-6FT-440CFM	ERK-10FT-550CFM

Additional Options	Part #	Description	Additional Depth	Racking Height	Finish
	ERK-44-F-EXT3	front extender	76mm	44 space	black powder coat
	ERK-44-R-EXT3	rear extender	76mm	44 space	black powder coat
	ERK-40-F-EXT3	front extender	76mm	40 space	black powder coat
	ERK-40-R-EXT3	rear extender	76mm	40 space	black powder coat
	PET-K-RD	pet kit, for rear door to rack bonding			
	PET-K-RDC	pet kit, rear cable door to rack			
PET-K-EXT	pet kit, door extender to rack				



BS-MRK-31

Inner Platform Base

Provides a handy platform, flush with bottom rackspace, for supporting heavy equipment and mounting electrical boxes. Fits inside rack.

Part #	Fits	Rack Depth
BS-BGR	BGR	all
BS-MRK-26	MRK	660mm
BS-MRK-31	MRK	787mm
BS-MRK-36	MRK	914mm
BS-MRK-42	MRK	1067mm
BS-WRK-27	WRK	686mm
BS-WRK-32	WRK	813mm



5WR

Swivel Casters

Bolt to bottom of all ERK and Slim 5 series rack systems adding 98mm overall height.

Part #	Description	Weight Capacity	Fits
5W	set of 4 commercial grade casters	590 kg	ERK, Slim 5
5WL	set of 4 commercial locking grade casters	590 kg	ERK, Slim 5
5WR	set of 4 fine floor casters	318 kg	ERK, Slim 5
5WLR	set of 4 locking fine floor casters	318 kg	ERK, Slim 5



CBS-ERK-20R

Skirted Caster Bases

Adds 95mm overall height. Commercial grade casters are UL Listed and have a weight capacity of 590 kg Fine floor casters protect flooring with a weight capacity of 318 kg.

Commercial Grade Caster Base Part #	Fine Floor Caster Base Part #	Fits	Rack Depth
CBS-5	CBS-5R	Slim 5	508mm
CBS-5-26	CBS-5-26R	Slim 5	660mm
CBS-ERK-20	CBS-ERK-20R	ERK	508mm
CBS-ERK-25	CBS-ERK-25R	ERK	635mm



CBS-MRK-31

Recessed Caster Bases

Adds 24mm overall height. Wheels come pre-installed and work with LF leveling feet. Commercial grade casters are UL Listed and have a weight capacity of 590 kg. The fine floor casters protect flooring with a weight capacity of 318 kg

Commercial Grade Caster Base Part #	Fine Floor Caster Base Part #	Fits	Rack Depth
CBS-BGR		BGR	all
CBS-WRK-27	CBS-WRK-27R	WRK	686mm
CBS-WRK-32	CBS-WRK-32R	WRK	813mm
CBS-MRK-26	CBS-MRK-26R	MRK	660mm
CBS-MRK-31	CBS-MRK-31R	MRK	787mm
CBS-MRK-36	CBS-MRK-36R	MRK	914mm
CBS-DRK-31		DRK	787mm
CBS-DRK-36		DRK	914mm

see rack series
pgs. for more
options



Seismic Floor Anchor Brackets

Anchoring bracket set supports a seismic-certified installation and can be used to reinforce any mission-critical application. One set required per rack.

Part #	Fits
BGR-Z4	BGR
WRK-Z4	WRK
MRK-Z4	MRK, DRK, VMRK
VRK-Z4	VRK
ERK-Z4	ERK
SNE24-Z4	610mm wide SNE
SNE27-Z4	701mm wide SNE
SNE30-Z4	762mm wide SNE
WMRK-Z4	WMRK



WMRK-Z4

Leveling Feet

Adjustable leveling feet fit Middle Atlantic floor standing steel racks that can be adjusted with a flat blade screwdriver or hex driver. One set required per rack.

Part #	Description	Fits
LF	10mm leveling feet	DRK, ERK, WRK, WRK-SA, VMRK, MRK
LF-HD	13mm leveling feet	BRG, BGR-SA, WMRK, SNE
LF-ISO	isolation leveling feet	DRK, ERK, WRK, WRK-SA, VMRK, MRK



LF

Ganging Hardware

Time-saving ganging hardware provides easy field alignment and joining of multi-bay enclosures.

Part #	Description
DRIFT	set of two tapered drift pins
MAG-1/2	set of two 13mm magnetic sockets
GANG-10	8mm nuts/bolts to gang 10 racks or consoles
GANG-10T	8mm bolts for ganging BGR and SNE via threaded inserts
TDRIFT	ganging drift pins, non-tapered



DRIFT

Spike, Rack Bonding Kits

Combines ganging and electrical bonding in one step by piercing powder coat finish at bonding points without removing paint.

- Eliminates bonding wires between racks
- Provides low impedance ground
- Displaces powder coat finish without corrosion protection of painted surface
- Does not require anti-oxidant protection
- Durable and visible green finish

Part #	Description
BOND-G24	24 sets, 1 installation tool, 4 sets recommended per rack



BOND-G24



see rack series
pgs. for more
options

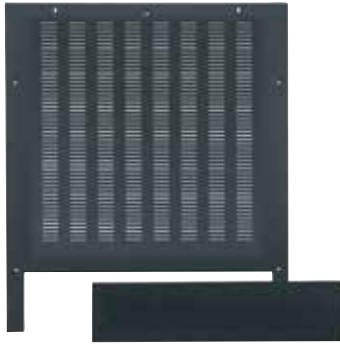

MW-VT

Solid and Vented Top Options

Select solid, slot pattern vented, or large perforated vented top options to address your thermal management needs.

Part #	Fits	Style
BGR-STP	BGR	solid
ERK-ST	ERK, WMRK	solid
ERK-VT	ERK, WMRK	slot pattern vented
ERK-LVT	ERK, WMRK	vented, 64% open area
MW-ST	DRK, MRK, VRK, VMRK, WRK, WRK	solid
MW-VT	DRK, MRK, VRK, VMRK, WRK, WRK	slot pattern vented
MW-LVT	DRK, MRK, VRK, VMRK, WRK, WRK	vented, 64% open area



- Organize cables
- Brush grommet panel pg. 213



MW-4FT

Fan Top Options - Non-Populated

Top options accept 119mm, 152mm or 254mm fans for active thermal management. See pg. 226 for fans.

Part #	Fits	Fan Openings	Style
ERK-4FT	ERK, WMRK	laser knockouts	mounts up to four 119mm fans (MW-4FT) or three 119mm fans (ERK-4FT)
ERK-6FT	ERK, WMRK	laser knockouts (MW-6FT) & finished holes (ERK-6FT)	mounts up to three 152mm fans (MW-6FT) or two 152mm fans (ERK-6FT)
ERK-10FT	ERK, WMRK	finished hole	mounts one 254mm fan
MW-4FT	DRK, MRK, VRK, VMRK, WR, WRK	laser knockouts	mounts up to four 119mm fans (MW-4FT) or three 119mm fans (ERK-4FT) or up to 4 grommets (GK-4G) for cable pass-through
MW-6FT	DRK, MRK, VRK, VMRK, WR, WRK	laser knockouts (MW-6FT) & finished holes (ERK-6FT)	mounts up to three 152mm fans (MW-6FT) or two 152mm fans (ERK-6FT)
MW-10FT	DRK, MRK, VRK, VMRK, WR, WRK	finished hole	mounts one 254mm fan

Top Options - Including Fans

Ships assembled. Integrated fan tops include 119mm, 152mm or 254mm fans, fan guards.



MW-6FT-660CFM

Part #	Fits	# of Fans	Free Air CFM
IBGR-276FT*	BGR	four quiet fans	276
IBGR-552FT*	BGR	eight quiet 119mm fans	552
ERK-4FT-285CFM	ERK, WMRK	three 119mm fans	285
ERK-6FT-440CFM	ERK, WMRK	two 152mm fans	440
ERK-10FT-550CFM	ERK, WMRK	one 254mm fan	550
MW-4FT-380CFM	CBS-MRK-26R	four 119mm fans	380
MW-6FT-660CFM	CBS-MRK-31R	three 152mm fans	660
MW-10FT-550CFM	CBS-MRK-36R	one 254mm fan	550

*Power supply wide range input 100VAC – 2240VAC and 50/60Hz compatible



see rack series pgs. for more options

240V THERMAL MANAGEMENT OPTION



Fans: (2) IFAN2-DC
pg. 226

+



Fan Controller:
FC-DC pg. 130

+



Top Options: ERK-4FT
or MW-4FT



Thermostatically Controlled Integrated Fan Top Options

Fan tops ship fully assembled and include 119mm, 152mm or 254mm fans, fan guards and proportional speed fan controller that increases fan life, reduces noise, saves energy, and reduces dust build up. ETL Listed in the US and Canada.

Part #	Fits	# of Fans	Free Air CFM
IBGR-276FT-FC*	BGR	four quiet 119mm fans	276
IBGR-552FT-FC*	BGR	eight quiet 119mm fans	552
ERK-4QFT-FC	ERK, WMRK	three quiet 119mm fans	165
ERK-10FT-FC	ERK, WMRK	one 254mm fan	550
MW-4QFT-FC	DRK, MRK, VRK, VMRK, WRK	four quiet 119mm fans	220
MW-10FT-FC	DRK, MRK, VRK, VMRK, WRK	one 254mm fan	550

*Power supply wide range input 100VAC – 2240VAC and 50/60Hz compatible



Vented Pagoda Top Options

Maintain enclosure temperatures through natural convection while minimizing the amount of dust and debris that can fall into the rack, and adds 38mm to the top of the rack.

Part #	Style
MW-PVTxx	vented pagoda top, MRK, VRK, VMRK only
xx = depth of MRK, VRK and VMRK only (660mm, 787mm, 914mm or 1067mm)	

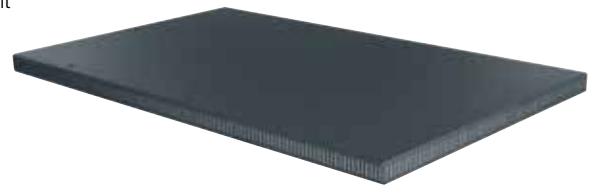

MV-PVT

Duct-Cool™ Adapter Top Options

Adapter top option to allow the Duct-Cool to be mounted to the top of select racks. Includes top and adapter only. Duct-Cool is a complete remote cooling solution that allows you to manage the heat in closets in racks.

Part #	Fits
ERK-DT	ERK, WMRK
MW-DT	DRK, MRK, VRK, VMRK, WRK
BGR-DT9	BGR



ERK-DT

Top Rail Kit

Convert the top into useable rackspace. Can be used in conjunction with our connector panels to allow for customizable connections in the top of the rack.

Part #	Fits	Description
MW-TR	WRK, MRK, VRK, VMRK, or DRK	13 space top rail kit

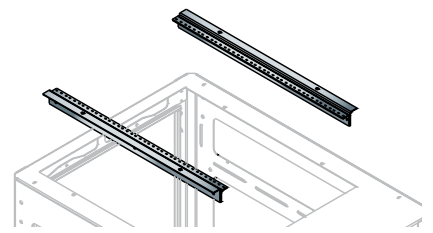

MW-TR

Ladder Adapter Top Option

Adapter used to connect cable ladder to the top of racks or cabinets.

Part #	Fits	Cable Ladder Sizes
MK-LA	MK, RLA, RL	305mm
MW-LA	DRK, MRK, VRK, VMRK, WRK	152mm, 229mm, 305mm



MW-LA

see rack series pgs. for more options



Locking Front Doors

Offered in lightly smoked plexi, 25% open area perf, 64% open area perf, plexi-vented and solid configurations. Beveled corners provide a stylish modern appearance while hinging either left or right. Black textured powder coat finish. Includes keylock.



BVFD-45



PFD-45



VFD-45

Solid Part #	Plexi Part #	Curved Plexi Part #	25% Open Area Perf Vented Part #	64% Open Area Perf Vented Part #	Curved Vented Part #	Plexi Vented Part #	Solid Split Part #	79% Open Area Split Perf Part #	Fully Vented Part #	Fits	# of Rackspace
BFD-19	BPFD-19	PFD-19A	–	–	VFD-19A	BVFD-19	–	–	–	BGR	19
BFD-25	BPFD-25	PFD-25A	–	–	VFD-25A	BVFD-25	–	–	–	BGR	25
BFD-38	BPFD-38	PFD-38A	–	–	VFD-38A	BVFD-38	–	–	–	BGR	38
BFD-41	BPFD-41	PFD-41A	–	–	VFD-41A	BVFD-41	–	–	–	BGR	41
BFD-45	BPFD-45	PFD-45A	–	–	VFD-45A	BVFD-45	–	–	–	BGR	45
–	DPFD-44	–	DVFD-44	DLVRD-447	–	DPVFD-44	DCRD-44	DCLVRD-44	DFVRD-44	DRK	44
FD-8	PFD-8	–	VFD-8	LVFD-8	–	–	–	–	–	DWR, ERK, MRK, SR, VRK, VMRK, WRK	8
FD-10	PFD-10	–	VFD-10	LVFD-10	–	–	–	–	–	DWR, ERK, MRK, SR, VRK, VMRK, WRK	10
FD-12	PFD-12	–	VFD-12	LVFD-12	–	–	–	–	–	DWR, ERK, MRK, SR, VRK, VMRK, WRK	12
FD-16	PFD-16	–	VFD-16	LVFD-16	–	–	–	–	–	DWR, ERK, MRK, SR, VRK, VMRK, WRK	16
FD-18	PFD-18	–	VFD-18	LVFD-18	–	–	–	–	–	DWR, ERK, MRK, SR, VRK, VMRK, WRK	18
FD-21	PFD-21	–	VFD-21	LVFD-21	–	–	–	–	–	DWR, ERK, MRK, SR, VRK, VMRK, WRK	21
FD-24	PFD-24	–	VFD-24	LVFD-24	–	–	–	–	–	DWR, ERK, MRK, SR, VRK, VMRK, WRK	24
FD-27	PFD-27	–	VFD-27	LVFD-27	–	–	–	–	–	DWR, ERK, MRK, SR, VRK, VMRK, WRK	27
FD-35	PFD-35	–	VFD-35	LVFD-35	–	–	–	–	–	DWR, ERK, MRK, SR, VRK, VMRK, WRK	35
FD-37	PFD-37	–	VFD-37	LVFD-37	–	–	–	–	–	DWR, ERK, MRK, SR, VRK, VMRK, WRK	37
FD-40	PFD-40	–	VFD-40	LVFD-40	–	–	–	–	–	DWR, ERK, MRK, SR, VRK, VMRK, WRK	40
FD-42	PFD-42	–	VFD-42	LVFD-42	–	–	–	–	–	DWR, ERK, MRK, SR, VRK, VMRK, WRK	42
FD-44	PFD-44	–	VFD-44	LVFD-44	–	PVFD-44	–	–	–	DWR, ERK, MRK, SR, VRK, VMRK, WRK	44
FD-45	PFD-45	–	VFD-45	LVFD-45	–	–	–	–	–	DWR, ERK, MRK, SR, VRK, VMRK, WRK	45
FD-46	PFD-46	–	VFD-46	LVFD-46	–	–	–	–	–	DWR, ERK, MRK, SR, VRK, VMRK, WRK	46
FD-54	PFD-54	–	VFD-54	LVFD-54	–	–	–	–	–	DWR, ERK, MRK, SR, VRK, VMRK, WRK	54

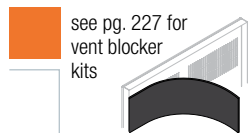



Rear Doors

Substitute a vented rear door for a solid rear door in selected sizes. Black textured powder coat finish. Fully vented rear doors have 64% open area. Split rear doors with 3 point latch offer 79% open area and require less floor space when accessing rear equipment connections.



DCLVRD-44



MW-LVRD-44



MW-CRD-44

Solid Split Part #	Top & Bottom Vented Slot Vented Part #	Slot Vents Fully Vented Part #	64% Open Area Split Perf Part #	79% Open Area Perf Part #	Fits	# of Rackspace
–	ERK-VRD-18	–	–	–	ERK	18
–	ERK-VRD-21	–	–	–	ERK	21
MW-CRD-24	–	–	–	MW-CLVRD-24	MRK, VRK, VMRK, WRK	24
–	ERK-VRD-27	–	–	–	ERK	27
–	ERK-VRD-35	–	–	–	ERK	35
–	–	–	–	–	MRK, VRK, VMRK, WRK	40
MW-CRD-42	–	–	–	MW-CLVRD-42	MRK, VRK, VMRK, WRK	42
DCRD-44	DVRD-44	DFVRD-44	DSVRD-44	DCLVRD-44	DRK	44
–	ERK-VRD-44	–	–	–	ERK	44
MW-CRD-44	MW-VRD-44	–	MW-LVRD-44	MW-CLVRD-44	MRK, VRK, VMRK, WRK	44
MW-CRD-45	–	–	–	MW-CLVRD-45	MRK, VRK, VMRK, WRK	45

High CFM Split Rear Doors

Protect equipment from the damaging effects of heat from servers, NVR's and DVR's with the adjustable 6 fan High CFM Rear Door. This cupboard style split rear door pulls hot air from the rear of the cabinet and directs it up towards return air ducts. Fan placement is adjustable for optimal airflow and up to 10 additional fans can be added for 3,520 CFM of free air movement. Two adjustable half blank panels included for versatile fan arrangement. Additional half blank panels are available for greater control of fan placement.

- Removes heat from high density installations such as servers and DVRs
- Split rear door design pulls hot air from rear and directs it upwards
- Fan placement is adjustable to match project needs
- Comes with 6 fans, together rated at 1,320 CFM in free air
- Up to 10 additional fans can be added for up to 3,520 CFM of movement

Part #	Description	Fits	Additional 13mm Blank Panels (Qty. of 4)	Free Air CFM
MW-CFRD-45	45 space split fan rear door	WMRK	MW-CFRD-1/2PNL-45	1,320
MW-CFRD-44	44 space split fan rear door	MRK, WRK, VRK	MW-CFRD-1/2PNL-44	1,320
MW-CFRD-42	42 space split fan rear door	WMRK	MW-CFRD-1/2PNL-42	1,320
D-CFRD-44	44 space split fan rear door	DRK	DCFRD-1/2PNL-44	1,320
MWCFRD-FKIT	additional 152mm fan for MW-CFRD and D-CFRD			220
FC-CFRD	fan controller, 1 rackspace			



MW-CFRD-1/2PNL-44



MW-CFRD-45

Power Solutions



100VAC

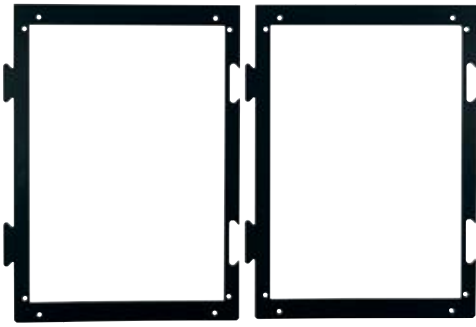

MRK-TEMP-26

Rack Base Templates

Use these handy bottom templates for pre-installation of floor anchor bolts prior to the arrival of the racks. Conveniently keyed to interlock, use two and “leapfrog” them to layout entire bays of racks.

Part #	Description
BGR-TEMP-27	bottom template for BGR-XX-27
BGR-TEMP-32	bottom template for BGR-XX-32
BGR-TEMP-38	bottom template for BGR-XX-38
MRK-TEMP-26	bottom template for MRK-XX-26
MRK-TEMP-31	bottom template for MRK-XX-31
MRK-TEMP-36	bottom template for MRK-XX-36
WRK-TEMP-27	bottom template for WRK-XX-27
WRK-TEMP-32	bottom template for WRK-XX-32



RBA-W44-2

Rail Bracket Adapters

Adapters allow for the vertical mounting of rack panels or electronics between rackrail brackets.

Part #	Description	Fits
RBA-W44-1	1 space adapter	44 space WRK
RBA-W44-2	2 space adapter	44 space WRK
RBA-W44-3	3 space adapter	44 space WRK
RBA-MV44-1	1 space adapter	44 space MRK/VRK
RBA-MV44-2	2 space adapter	44 space MRK/VRK
RBA-MV44-3	3 space adapter	44 space MRK/VRK

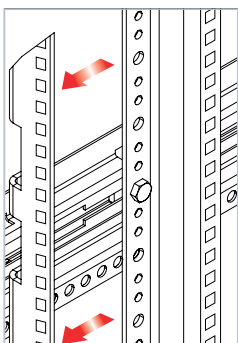

PROWMRK-ZRA-42

Z-Rail Adapters

The Z-Rail adapters convert standard rackrail to “Z” style to supports side mounted applications. Sold in pairs.

Part #	Fits
MV-ZRA-44	44 space MRK/VRK
PROR4CN-ZRA45	45 space R4CN
PROR4CN-ZRA51	51 space R4CN
PROWMRK-ZRA-24	24 space WMRK
PROWMRK-ZRA-42	42 space WMRK
PROWMRK-ZRA-45	45 space WMRK

see rack series
pgs. for more
options



SRB Series, Seismic Riser Bases

- Allows for field rough-in prior to arrival of racks and enclosures
- Acts as a lower cable chase for passing cables between racks
- Heavy-gauge welded steel construction, with black powder coat finish



Part #	Bays	Accommodates	Seismic Brackets (1 set required per rack)
SRB-1-BGR-3224	1	BGR 813mm depth racks	BGR-Z4/BGR-ISO-Z4
SRB-2-BGR-3224	2	BGR 813mm depth racks	BGR-Z4/BGR-ISO-Z4
SRB-3-BGR-3224	3	BGR 813mm depth racks	BGR-Z4/BGR-ISO-Z4
SRB-1-BGR-3824	1	BGR 965mm depth racks	BGR-Z4/BGR-ISO-Z4
SRB-2-BGR-3824	2	BGR 965mm depth racks	BGR-Z4/BGR-ISO-Z4
SRB-3-BGR-3824	3	BGR 965mm depth racks	BGR-Z4/BGR-ISO-Z4
SRB-1-DRK-3124	1	DRK 787mm depth racks	MRK-Z4
SRB-2-DRK-3124	2	DRK 787mm depth racks	MRK-Z4
SRB-1-DRK-3624	1	DRK 914mm depth racks	MRK-Z4
SRB-2-DRK-3624	2	DRK 914mm depth racks	MRK-Z4
SRB-1-DRK-4224	1	DRK 1067mm depth racks	MRK-Z4
SRB-2-DRK-4224	2	DRK 1067mm depth racks	MRK-Z4
SRB-1-DRK-4824	1	DRK 1219mm depth racks	MRK-Z4
SRB-2-DRK-4824	2	DRK 1219mm depth racks	MRK-Z4
SRB-1-MRK-2624	1	MRK 660mm depth racks	MRK-Z4
SRB-2-MRK-2624	2	MRK 660mm depth racks	MRK-Z4
SRB-3-MRK-2624	3	MRK 660mm depth racks	MRK-Z4
SRB-1-MRK-3124	1	MRK 787mm & VRK 787mm depth racks	MRK-Z4, VRK-Z4
SRB-2-MRK-3124	2	MRK 787mm & VRK 787mm depth racks	MRK-Z4, VRK-Z4
SRB-3-MRK-3124	3	MRK 787mm & VRK 787mm depth racks	MRK-Z4, VRK-Z4
SRB-1-MRK-3624	1	MRK 914mm & VRK 914mm depth racks	MRK-Z4, VRK-Z4
SRB-2-MRK-3624	2	MRK 914mm & VRK 914mm depth racks	MRK-Z4, VRK-Z4
SRB-3-MRK-3624	3	MRK 914mm & VRK 914mm depth racks	MRK-Z4, VRK-Z4
SRB-1-MRK-4224	1	MRK 1067mm & VRK 1067mm depth racks	MRK-Z4, VRK-Z4
SRB-2-MRK-4224	2	MRK 1067mm & VRK 1067mm depth racks	MRK-Z4, VRK-Z4
SRB-3-MRK-4224	3	MRK 1067mm & VRK 1067mm depth racks	MRK-Z4, VRK-Z4
SRB-1-MRK-4824	1	MRK 1219mm & VRK 1219mm depth racks	MRK-Z4, VRK-Z4
SRB-2-MRK-4824	2	MRK 1219mm & VRK 1219mm depth racks	MRK-Z4, VRK-Z4
SRB-3-MRK-4824	3	MRK 1219mm & VRK 1219mm depth racks	MRK-Z4, VRK-Z4

Custom heights & depths available on request 229mm- 610mm.

Part #	Bays	Accommodates	Seismic Brackets (1 set required per rack)
SRB-1-SNE24-3624	1	SNE 914mm depth racks	SNE24-Z4
SRB-2-SNE24-3624	2	SNE 914mm depth racks	SNE24-Z4
SRB-1-SNE24-4224	1	SNE 1067mm depth racks	SNE24-Z4
SRB-2-SNE24-4224	2	SNE 1067mm depth racks	SNE24-Z4
SRB-1-SNE24-4824	1	SNE 1219mm depth racks	SNE24-Z4
SRB-2-SNE24-4824	2	SNE 1219mm depth racks	SNE24-Z4
SRB-1-SNE27-3624	1	SNE 914mm depth racks	SNE27-Z4
SRB-2-SNE27-3624	2	SNE 914mm depth racks	SNE27-Z4
SRB-1-SNE27-4224	1	SNE 1067mm depth racks	SNE27-Z4
SRB-2-SNE27-4224	2	SNE 1067mm depth racks	SNE27-Z4
SRB-1-SNE27-4824	1	SNE 1219mm depth racks	SNE27-Z4
SRB-2-SNE27-4824	2	SNE 1219mm depth racks	SNE27-Z4
SRB-1-SNE30-3624	1	SNE 914mm depth racks	SNE30-Z4
SRB-2-SNE30-3624	2	SNE 914mm depth racks	SNE30-Z4
SRB-1-SNE30-4224	1	SNE 1067mm depth racks	SNE30-Z4
SRB-2-SNE30-4224	2	SNE 1067mm depth racks	SNE30-Z4
SRB-1-SNE30-4824	1	SNE 1219mm depth racks	SNE30-Z4
SRB-2-SNE30-4824	2	SNE 1219mm depth racks	SNE30-Z4
SRB-1-WMRK-3124	1	WMRK 787mm depth racks	WMRK-Z4
SRB-2-WMRK-3124	2	WMRK 787mm depth racks	WMRK-Z4
SRB-1-WMRK-3624	1	WMRK 914mm depth racks	WMRK-Z4
SRB-2-WMRK-3624	2	WMRK 914mm depth racks	WMRK-Z4
SRB-1-WMRK-4224	1	WMRK 1067mm depth racks	WMRK-Z4
SRB-2-WMRK-4224	2	WMRK 1067mm depth racks	WMRK-Z4
SRB-1-WMRK-4824	1	WMRK 1219mm depth racks	WMRK-Z4
SRB-2-WMRK-4824	2	WMRK 1219mm depth racks	WMRK-Z4
SRB-1-WRK-2724	1	WRK 686mm depth racks	WRK-Z4
SRB-2-WRK-2724	2	WRK 686mm depth racks	WRK-Z4
SRB-3-WRK-2724	3	WRK 686mm depth racks	WRK-Z4
SRB-1-WRK-3224	1	WRK 813mm depth racks	WRK-Z4
SRB-2-WRK-3224	2	WRK 813mm depth racks	WRK-Z4
SRB-3-WRK-3224	3	WRK 813mm depth racks	WRK-Z4



see rack series
pgs. for more
options

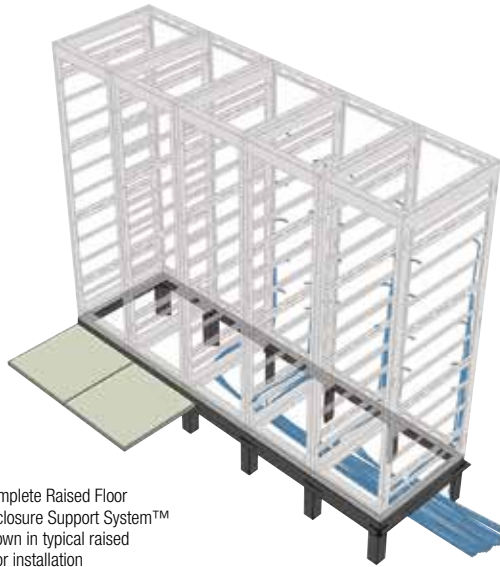

Complete Raised Floor Enclosure Support System™ shown in typical raised floor installation

simplifies installation



The **Raised Floor Enclosure Support System™** provides the ability to perform field rough-in procedures prior to the arrival of racks and enclosures.

- Timesaving and practical system to rough-in rack installations
- Heavy-duty welded construction with black powder coat finish
- System includes 2-13mm high bases, riser feet and support angles
- Base matches rack sizes, and allows cables to pass underneath
- Riser feet raise the base to match raised floor installations
- Support angles support floor tiles surrounding the racks
- Custom sizes and heights are available



RIB Series Riser Base shown with MRK racks and custom cable chase

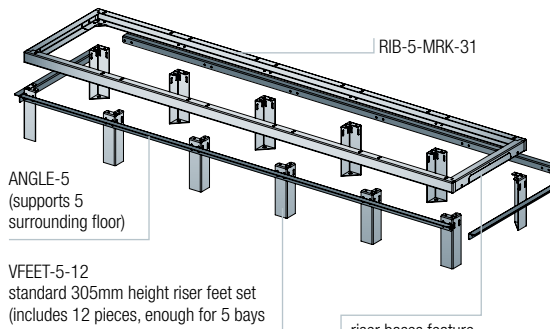

custom height riser feet available, please call for details

riser bases feature cable pass-through laser knockouts for use when joining multiple bases

Certifications

- RoHS
- GREENGUARD



RIB Series Riser Bases Part #	Bays	Raised Floor Riser Feet Part #	Raised Floor Support Angles Part #	Accommodates
RIB-1-BGR-27	1	VFEET-1-12	BANGLE-1	BGR 686mm depth racks
RIB-2-BGR-27	2	VFEET-2-12	BANGLE-2	BGR 686mm depth racks
RIB-3-BGR-27	3	VFEET-3-12	BANGLE-3	BGR 686mm depth racks
RIB-4-BGR-27	4	VFEET-4-12	BANGLE-4	BGR 686mm depth racks
RIB-5-BGR-27	5	VFEET-5-12	BANGLE-5	BGR 686mm depth racks
RIB-1-BGR-32	1	VFEET-1-12	BANGLE-1	BGR 813mm depth racks
RIB-2-BGR-32	2	VFEET-2-12	BANGLE-2	BGR 813mm depth racks
RIB-3-BGR-32	3	VFEET-3-12	BANGLE-3	BGR 813mm depth racks
RIB-4-BGR-32	4	VFEET-4-12	BANGLE-4	BGR 813mm depth racks
RIB-5-BGR-32	5	VFEET-5-12	BANGLE-5	BGR 813mm depth racks
RIB-1-BGR-38	1	VFEET-1-12	BANGLE-1-38	BGR 965mm depth racks
RIB-2-BGR-38	2	VFEET-2-12	BANGLE-2-38	BGR 965mm depth racks
RIB-3-BGR-38	3	VFEET-3-12	BANGLE-3-38	BGR 965mm depth racks
RIB-4-BGR-38	4	VFEET-4-12	BANGLE-4-38	BGR 965mm depth racks
RIB-5-BGR-38	5	VFEET-5-12	BANGLE-5-38	BGR 965mm depth racks
RIB-1-DRK-31	1	VFEET-1-12	DANGLE-1-31	DRK 787mm depth racks
RIB-2-DRK-31	2	VFEET-2-12	DANGLE-2-31	DRK 787mm depth racks
RIB-3-DRK-31	3	VFEET-3-12	DANGLE-3-31	DRK 787mm depth racks
RIB-1-DRK-36	1	VFEET-1-12	DANGLE-1-3642	DRK 914mm depth racks
RIB-2-DRK-36	2	VFEET-2-12	DANGLE-2-3642	DRK 914mm depth racks
RIB-3-DRK-36	3	VFEET-3-12	DANGLE-3-3642	DRK 914mm depth racks
RIB-1-DRK-42	1	VFEET-1-12	DANGLE-1-3642	DRK 1067mm depth racks
RIB-2-DRK-42	2	VFEET-2-12	DANGLE-2-3642	DRK 1067mm depth racks
RIB-3-DRK-42	3	VFEET-3-12	DANGLE-3-3642	DRK 1067mm depth racks
RIB-1-MRK-26	1	VFEET-1-12	ANGLE-1	MRK 660mm depth racks
RIB-2-MRK-26	2	VFEET-2-12	ANGLE-2	MRK 660mm depth racks
RIB-3-MRK-26	3	VFEET-3-12	ANGLE-3	MRK 660mm depth racks
RIB-4-MRK-26	4	VFEET-4-12	ANGLE-4	MRK 660mm depth racks
RIB-5-MRK-26	5	VFEET-5-12	ANGLE-5	MRK 660mm depth racks
RIB-1-MRK-31	1	VFEET-1-12	ANGLE-1	MRK/VMRK/VRK 787mm depth racks
RIB-2-MRK-31	2	VFEET-2-12	ANGLE-2	MRK/VMRK/VRK 787mm depth racks
RIB-3-MRK-31	3	VFEET-3-12	ANGLE-3	MRK/VMRK/VRK 787mm depth racks
RIB-4-MRK-31	4	VFEET-4-12	ANGLE-4	MRK/VMRK/VRK 787mm depth racks
RIB-5-MRK-31	5	VFEET-5-12	ANGLE-5	MRK/VMRK/VRK 787mm depth racks
RIB-1-MRK-36	1	VFEET-1-12	ANGLE-1-36	MRK/VRK 914mm depth racks
RIB-2-MRK-36	2	VFEET-2-12	ANGLE-2-36	MRK/VRK 914mm depth racks
RIB-3-MRK-36	3	VFEET-3-12	ANGLE-3-36	MRK/VRK 914mm depth racks
RIB-4-MRK-36	4	VFEET-4-12	ANGLE-4-36	MRK/VRK 914mm depth racks
RIB-5-MRK-36	5	VFEET-5-12	ANGLE-5-36	MRK/VRK 914mm depth racks
RIB-1-MRK-42	1	VFEET-1-12	ANGLE-1-42	MRK/VRK 1067mm depth racks
RIB-2-MRK-42	2	VFEET-2-12	ANGLE-2-42	MRK/VRK 1067mm depth racks
RIB-3-MRK-42	3	VFEET-3-12	ANGLE-3-42	MRK/VRK 1067mm depth racks

RIB Series Riser Bases Part #	Bays	Raised Floor Riser Feet Part #	Raised Floor Support Angles Part #	Accommodates
RIB-1-SNE24-36	1	VFEET-1-12	SANGLE24-1-3642	SNE 914mm depth racks
RIB-2-SNE24-36	2	VFEET-2-12	SANGLE24-2-3642	SNE 914mm depth racks
RIB-3-SNE24-36	3	VFEET-3-12	SANGLE24-3-3642	SNE 914mm depth racks
RIB-1-SNE24-42	1	VFEET-1-12	SANGLE24-1-3642	SNE 1067mm depth racks
RIB-2-SNE24-42	2	VFEET-2-12	SANGLE24-2-3642	SNE 1067mm depth racks
RIB-3-SNE24-42	3	VFEET-3-12	SANGLE24-3-3642	SNE 1067mm depth racks
RIB-1-SNE24-48	1	VFEET-1-12	SANGLE24-1-48	SNE 1219mm depth racks
RIB-2-SNE24-48	2	VFEET-2-12	SANGLE24-2-48	SNE 1219mm depth racks
RIB-3-SNE24-48	3	VFEET-3-12	SANGLE24-3-48	SNE 1219mm depth racks
RIB-1-SNE27-36	1	VFEET-1-12	SANGLE27-1-3642	SNE 914mm depth racks
RIB-2-SNE27-36	2	VFEET-2-12	SANGLE27-2-3642	SNE 914mm depth racks
RIB-3-SNE27-36	3	VFEET-3-12	SANGLE27-3-3642	SNE 914mm depth racks
RIB-1-SNE27-42	1	VFEET-1-12	SANGLE27-1-3642	SNE 1067mm depth racks
RIB-2-SNE27-42	2	VFEET-2-12	SANGLE27-2-3642	SNE 1067mm depth racks
RIB-3-SNE27-42	3	VFEET-3-12	SANGLE27-3-3642	SNE 1067mm depth racks
RIB-1-SNE27-48	1	VFEET-1-12	SANGLE27-1-48	SNE 1219mm depth racks
RIB-2-SNE27-48	2	VFEET-2-12	SANGLE27-2-48	SNE 1219mm depth racks
RIB-3-SNE27-48	3	VFEET-3-12	SANGLE27-3-48	SNE 1219mm depth racks
RIB-1-SNE30-36	1	VFEET-1-12	SANGLE30-1-3642	SNE 914mm depth racks
RIB-2-SNE30-36	2	VFEET-2-12	SANGLE30-2-3642	SNE 914mm depth racks
RIB-3-SNE30-36	3	VFEET-3-12	SANGLE30-3-3642	SNE 914mm depth racks
RIB-1-SNE30-42	1	VFEET-1-12	SANGLE30-1-3642	SNE 1067mm depth racks
RIB-2-SNE30-42	2	VFEET-2-12	SANGLE30-2-3642	SNE 1067mm depth racks
RIB-3-SNE30-42	3	VFEET-3-12	SANGLE30-3-3642	SNE 1067mm depth racks
RIB-1-SNE30-48	1	VFEET-1-12	SANGLE30-1-48	SNE 1219mm depth racks
RIB-2-SNE30-48	2	VFEET-2-12	SANGLE30-2-48	SNE 1219mm depth racks
RIB-3-SNE30-48	3	VFEET-3-12	SANGLE30-3-48	SNE 1219mm depth racks
RIB-1-WMRK-36	1	VFEET-1-12	WMANGLE-1-3642	WMRK 914mm depth racks
RIB-2-WMRK-36	2	VFEET-2-12	WMANGLE-2-3642	WMRK 914mm depth racks
RIB-3-WMRK-36	3	VFEET-3-12	WMANGLE-3-3642	WMRK 914mm depth racks
RIB-1-WMRK-42	1	VFEET-1-12	WMANGLE-1-3642	WMRK 1067mm depth racks
RIB-2-WMRK-42	2	VFEET-2-12	WMANGLE-2-3642	WMRK 1067mm depth racks
RIB-3-WMRK-42	3	VFEET-3-12	WMANGLE-3-3642	WMRK 1067mm depth racks
RIB-1-WMRK-48	1	VFEET-1-12	WMANGLE-1-48	WMRK 1219mm depth racks
RIB-2-WMRK-48	2	VFEET-2-12	WMANGLE-2-48	WMRK 1219mm depth racks
RIB-1-WRK-27	1	VFEET-1-12	WANGLE-1	WRK 686mm deep racks
RIB-2-WRK-27	2	VFEET-2-12	WANGLE-2	WRK 686mm deep racks
RIB-3-WRK-27	3	VFEET-3-12	WANGLE-3	WRK 686mm deep racks
RIB-4-WRK-27	4	VFEET-4-12	WANGLE-4	WRK 686mm deep racks
RIB-5-WRK-27	5	VFEET-5-12	WANGLE-5	WRK 686mm deep racks
RIB-1-WRK-32	1	VFEET-1-12	WANGLE-1	WRK 813mm deep racks
RIB-2-WRK-32	2	VFEET-2-12	WANGLE-2	WRK 813mm deep racks
RIB-3-WRK-32	3	VFEET-3-12	WANGLE-3	WRK 813mm deep racks
RIB-4-WRK-32	4	VFEET-4-12	WANGLE-4	WRK 813mm deep racks
RIB-5-WRK-32	5	VFEET-5-12	WANGLE-5	WRK 813mm deep racks



5-29-CONFIG

Slim 5 Series

Configured and ships complete with:

Power Distribution	Cable Management	Rack Accessories
vertical 15 Amp filtered and surge protected power	vertical lacing strips	vented shelves
		vent panels
		set of 4 casters

Part #	Racking Height	Useable Depth	Height with Casters	# of Vented Shelves & Panels
5-14-CONFIG	2114mm (14 space)	514mm	818mm	3 shelves, 2 vent panels
5-29-CONFIG	1289mm (29 space)	514mm	1486mm	5 shelves, 5 vent panels
5-37-CONFIG	1645mm (37 space)	514mm	1842mm	6 shelves, 6 vent panels



ERK-2725-CONFIG

ERK Series

Configured and ships complete with:

Power Distribution	Cable Management	Rack Accessories
vertical 15 Amp filtered and surge protected power	vertical lacing strips	vented shelves (including 1 telescoping full depth heavy duty shelf)
	horizontal lacing bars	vent panels
		caster base

Part #	Racking Height	Useable Depth	Height with Casters	# of Vented Shelves & Panels
ERK-2125-CONFIG	933mm (21 space)	597mm	1143mm	4 shelves, 3 vent panels
ERK-2725-CONFIG	1199mm (27 space)	597mm	1410mm	5 shelves, 4 vent panels
ERK-3525-CONFIG	1556mm (35 space)	597mm	1765mm	6 shelves, 5 vent panels



ERK-4025-AV

ERK Series - AV Enclosures

Configured and ships complete with:

Thermal Management	Cable Management	Power Distribution	Accessories
integrated fan top	vertical lacer strip 83mm width (LACE-OP Series)	for 44 space enclosures: 1 qty 20 Amp, 20 outlet power strip with cord, (PDT-2020C-NS)	solid front and configurable rear door, locking
rear door bottom vent	horizontal lacer bars, four 'L' shaped straight and two 102mm offset	for 35 and 40 space enclosures: 2 qty 20 Amp, 10 outlet power strip with cord, (PDT-1020C-NS)	10-32 threaded rack screws, 100 qty
vent blockers	velcro® cable management straps, 203mm length, 12 qty		leveling feet, 4 qty

Part #	Racking Height	Overall Height	Useable Depth	Overall Depth	Overall Width
ERK-3525-AV	1556mm (35 space)	597mm	1010mm	635mm	559mm
ERK-4025-AV	1778mm (40 space)	597mm	1143mm	635mm	559mm
ERK-4425-AV	1956mm (44 space)	597mm	1410mm	635mm	559mm





MRK Series - NVR/DVR Enclosures

Configured and ships complete with:

Ships Complete With			DVR Enclosure	NVR Enclosure
64% open area front door	83mm width vertical lacer strip (LACE-44-OP)	side panels (as noted in table)	two pairs 10-32 threaded rackrail	two pairs cage nut style rackrail
79% open area split rear door	horizontal lacer bars, four 'L' shaped straight and two 102mm offset	ganging hardware (models without side panels only)	10-32 threaded rack screws, 100 qty	one pair of cage nut style Z-rail adaptors
20 Amp, 20 outlet power strip with cord (PDT-2020C-NS)	one each 1 space and 2 space brush grommet	leveling feet		6 mm threaded cage nuts & rack screws, 100 qty
64% open area top	velcro® cable management straps	-		10-32 threaded cage nuts & rack screws, 50 qty

Part #	Racking Height	Overall Height	Useable Depth	Overall Depth	Overall Width	Includes Side Panels
MRK-4431-DVR	1956mm (44 space)	2111mm	737mm	797mm	591mm	Yes
MRK-4431-DVR-AB	1956mm (44 space)	2111mm	737mm	797mm	559mm	No
MRK-4436-NVR	1956mm (44 space)	2111mm	852mm	914mm	591mm	Yes
MRK-4436-NVR-AB	1956mm (44 space)	2111mm	852mm	914mm	559mm	No



MRK-4426-AV-AB

WMRK Series - Server Enclosures

Configured and ships complete with:

Ships Complete With						
70% open area front door, locking	64% open area top	vertical lacing strip, 83mm width (42 space only)	one pair of cage nut style Z-rail adaptors	6mm rack screws, 100 quantity	for 24 space enclosures: 20 Amp, 10 outlet power strip with cord	ganging hardware (models without side panels only)
79% open area split rear door, locking	temperature monitoring module	two pairs cage nut style rackrail	6mm cage nuts, 100 quantity	side panels (as noted in table)	for 42 space enclosures: 20 Amp, 20 outlet power strip with cord	leveling feet

Part #	Racking Height	Overall Height	Useable Depth	Overall Depth	Overall Width	Includes Side Panels
WMRK-2436SVR	1067mm (24 space)	1235mm	852mm	914mm	641mm	Yes
WMRK-2436SVR-AB	1067mm (24 space)	1235mm	852mm	914mm	610mm	No
WMRK-4236SVR	1867mm (42 space)	2034mm	852mm	914mm	641mm	Yes
WMRK-4236SVR-AB	1867mm (42 space)	2034mm	852mm	914mm	610mm	No
WMRK-4242SVR	1867mm (42 space)	2034mm	1005mm	1067mm	641mm	Yes
WMRK-4242SVR-AB	1867mm (42 space)	2034mm	1005mm	1067mm	610mm	No



WMRK-4236SVR-AB

MRK Series - AV Enclosures

Configured and ships complete with:

Thermal Management	Cable Management	Power Distribution	Accessories
integrated fan top, with proportional speed fan control	vertical lacer strip 83mm width (LACE-OP Series)	1 qty 20 Amp, 20 outlet power strip with cord (PDT-2020C-NS)	solid front and configurable rear door, locking
rear door bottom vent	horizontal lacer bars, four 'L' shaped straight and two 102mm offset		10-32 threaded rack screws, 100 qty
vent blockers	velcro® cable management straps, 203mm length, 12 qty		leveling feet, 4 qty
-	-		ganging hardware (MRK open side models only)

Part #	Racking Height	Overall Height	Useable Depth	Overall Depth	Overall Width	Includes Side Panels
MRK-4426-AV	1956mm (44 space)	2111mm	610mm	673mm	592mm	Yes
MRK-4426-AV-AB	1956mm (44 space)	2111mm	610mm	673mm	559mm	No
MRK-4431-AV	1956mm (44 space)	2111mm	737mm	800mm	592mm	Yes
MRK-4431-AV-AB	1956mm (44 space)	2111mm	737mm	800mm	559mm	No



MRK-4426-AV-AB

Configured Enclosures Power Solutions



100VAC



wall mount racks and cabinets

Wall racks save floor space and are ideal for smaller installations or to house system distribution points. Many wall rack styles are available to meet a wide range of project needs.

Open-frame styles are great for controlled spaces such as utility rooms and some models can be mounted over conduit and similar obstructions.

Enclosed models provide security to protect equipment in more open spaces from tampering,



dust, and other hazards, and many styles have hinged center sections to provide enhanced rear access to equipment and wiring.

Wall racks range in capacity from 2 to 35 rackspaces, with the hybrid wall/floor mounted SR models up to 46 spaces.

SR Series	58 - 59
DWR Series	60 - 61
EWR Series	62 - 63
CWR Series	64 - 65
SWR and SBX Series	66 - 67
TOR and WRS/WRP Series	68 - 69
SFR and WM Series	70 - 71
HDR and SPM Series	72 - 73
VPM and PPM Series	74 - 75
HPM and DLBX/VLBX Series	76 - 77



SR-40-22

pivoting sectional wall/floor cabinet



The **SR Series** provides access to rear equipment connections for large to medium systems.

- Patented tool free Quick-Mount™ system for center section mounting
- Pivots 90° on floor base for access to rear equipment connections
- Standard adjustable front 10-32 threaded rackrail
- “Bonus” 4 rackspace in base is ideal for mounting a UPS or other equipment
- 227 kg weight capacity

Certifications

- Seismic Certification
- RoHS
- GREENGUARD
- UL2416

Market Solutions



Broadcast



Commercial
AV



Residential
AV



Security



Structured
Cabling



Education



International
Fan Available



Thermal Top Options pg. 46

- 240V Fans pg. 226
- Fan Controller pg. 130



Product Information

Part #	Racking Height	Overall Height	Useable Depth	Overall Depth	Overall Width	Weight Capacity
SR-24-28	1067mm (24 space)	1594mm	660mm	721mm	622mm	227 kg
SR-24-32	1067mm (24 space)	1594mm	762mm	822mm	622mm	227 kg
SR-40-22	1778mm (40 space)	2305mm	508mm	568mm	622mm	227 kg
SR-40-28	1778mm (40 space)	2305mm	660mm	721mm	622mm	227 kg
SR-40-32	1778mm (40 space)	2305mm	762mm	822mm	622mm	227 kg
SR-46-28	2045mm (46 space)	2572mm	660mm	721mm	622mm	227 kg



- Based designed to fit UPS back up power see pg. 166

Options

Please visit our website for more info.

Fits Part #	Front Doors				Additional 10-32 Threaded Rackrail
	Solid	Plexi	25% Open Area Perf	64% Open Area Perf	
SR-24-28	FD-24	PFD-24	VFD-24	LVFD-24	DWR-RR24
SR-24-32	FD-24	PFD-24	VFD-24	LVFD-24	DWR-RR24
SR-40-22	FD-40	PFD-40	VFD-40	LVFD-40	DWR-RR40
SR-40-28	FD-40	PFD-40	VFD-40	LVFD-40	DWR-RR40
SR-40-32	FD-40	PFD-40	VFD-40	LVFD-40	DWR-RR40
SR-46-28	FD-46	PFD-46	VFD-46	-	DWR-RR46

Additional Options:



DWRSR-ZL
minimum clearance latch for side-by-side wall rackmounting

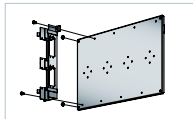

SR-SUB
sub-plate mounting kit for SR Series backpan supports mounting of 89-D type brackets and electrical brackets

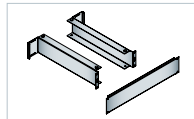

SR-UPS-BKT
UPS support bracket for SR Series supports mounting of Middle Atlantic UPS in SR base section

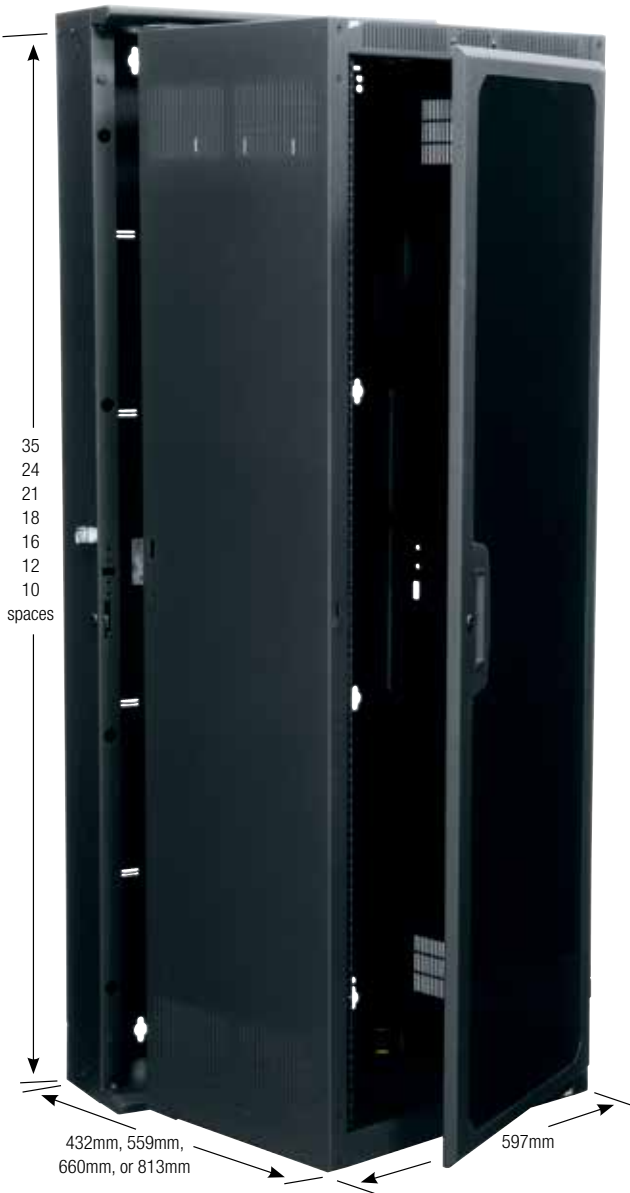

DWR-35-22PD

pivoting sectional wall cabinet



The **DWR Series** provides access to rear equipment connections for medium to small systems.

- Robust welded steel construction
- Patented tool free Quick-Mount™ system for center section mounting
- Center section swing is reversible, and can be both keylocked and padlocked
- Center section is keyed differently from optional front door for security
- Designed for choice of active or passive cooling

Certifications

- Seismic Certification
- UL Listed
- RoHS
- UL2416
- OSHPD

Market Solutions



Broadcast



Commercial
AV



Residential
AV



Security



Structured
Cabling



Education



International
Fan Available



Product Information

Part #	Fully Assembled with Plexi Front Door Part #	Racking Height	Overall Height	Useable Depth	Overall Depth	Weight Capacity
DWR-10-17	DWR-10-17PD	445mm (10 space)	622mm	381mm	432mm	91 kg
DWR-10-22	DWR-10-22PD	445mm (10 space)	622mm	508mm	559mm	91 kg
DWR-12-17	DWR-12-17PD	533mm (12 space)	711mm	381mm	432mm	91 kg
DWR-12-22	DWR-12-22PD	533mm (12 space)	711mm	508mm	559mm	91 kg
DWR-12-26	DWR-12-26PD	533mm (12 space)	711mm	610mm	660mm	91 kg
DWR-12-32	-	533mm (12 space)	711mm	762mm	813mm	91 kg
DWR-16-17	DWR-16-17PD	711mm (16 space)	889mm	381mm	432mm	91 kg
DWR-16-22	DWR-16-22PD	711mm (16 space)	889mm	508mm	559mm	91 kg
DWR-18-17	DWR-18-17PD	800mm (18 space)	978mm	381mm	432mm	113 kg
DWR-18-22	DWR-18-22PD	800mm (18 space)	978mm	508mm	559mm	113 kg
DWR-18-26	DWR-18-26PD	800mm (18 space)	978mm	610mm	660mm	113 kg
DWR-18-32	-	800mm (18 space)	978mm	762mm	813mm	113 kg
DWR-21-17	DWR-21-17PD	933mm (21 space)	1111mm	381mm	432mm	113 kg
DWR-21-22	DWR-21-22PD	933mm (21 space)	1111mm	508mm	559mm	113 kg
DWR-24-17	DWR-24-17PD	1067mm (24 space)	1245mm	381mm	432mm	136 kg
DWR-24-22	DWR-24-22PD	1067mm (24 space)	1245mm	508mm	559mm	136 kg
DWR-24-26	DWR-24-26PD	1067mm (24 space)	1245mm	610mm	660mm	136 kg
DWR-24-32	-	1067mm (24 space)	1245mm	762mm	813mm	136 kg
DWR-35-17	-	1556mm (35 space)	1734mm	381mm	432mm	136 kg
DWR-35-22	DWR-35-22PD	1556mm (35 space)	1734mm	508mm	559mm	136 kg
DWR-35-26	DWR-35-26PD	1556mm (35 space)	1734mm	610mm	660mm	136 kg

Options

Please visit our website for more info.

Fits Part #	Front Doors				Exhaust Fan Kit	Additional 10-32 Threaded Rackrail
	Solid	Plexi	25% Open Area Perf	64% Open Area Perf		
DWR-10-17	FD-10	PFD-10	VFD-10	LVFD-10	DWR-FK17	DWR-RR10
DWR-10-22	FD-10	PFD-10	VFD-10	LVFD-10	DWR-FK22	DWR-RR10
DWR-12-17	FD-12	PFD-12	VFD-12	LVFD-12	DWR-FK17	DWR-RR12
DWR-12-22	FD-12	PFD-12	VFD-12	LVFD-12	DWR-FK22	DWR-RR12
DWR-12-26	FD-12	PFD-12	VFD-12	LVFD-12	DWR-FK26	DWR-RR12
DWR-12-32	FD-12	PFD-12	VFD-12	LVFD-12	DWR-FK32	DWR-RR12
DWR-16-17	FD-16	PFD-16	VFD-16	LVFD-16	DWR-FK17	DWR-RR16
DWR-16-22	FD-16	PFD-16	VFD-16	LVFD-16	DWR-FK22	DWR-RR16
DWR-18-17	FD-18	PFD-18	VFD-18	LVFD-18	DWR-FK17	DWR-RR18
DWR-18-22	FD-18	PFD-18	VFD-18	LVFD-18	DWR-FK22	DWR-RR18
DWR-18-26	FD-18	PFD-18	VFD-18	LVFD-18	DWR-FK26	DWR-RR18
DWR-18-32	FD-18	PFD-18	VFD-18	LVFD-18	DWR-FK32	DWR-RR18
DWR-21-17	FD-21	PFD-21	VFD-21	LVFD-21	DWR-FK17	DWR-RR21
DWR-21-22	FD-21	PFD-21	VFD-21	LVFD-21	DWR-FK22	DWR-RR21
DWR-24-17	FD-24	PFD-24	VFD-24	LVFD-24	DWR-FK17	DWR-RR24
DWR-24-22	FD-24	PFD-24	VFD-24	LVFD-24	DWR-FK22	DWR-RR24
DWR-24-26	FD-24	PFD-24	VFD-24	LVFD-24	DWR-FK26	DWR-RR24
DWR-24-32	FD-24	PFD-24	VFD-24	LVFD-24	DWR-FK32	DWR-RR24
DWR-35-17	FD-35	PFD-35	VFD-35	LVFD-35	DWR-FK17	DWR-RR35
DWR-35-22	FD-35	PFD-35	VFD-35	LVFD-35	DWR-FK22	DWR-RR35
DWR-35-26	FD-35	PFD-35	VFD-35	LVFD-35	DWR-FK26	DWR-RR35

Additional Options:



DWR-CVR cover plate/shelf kit



DWRSR-ZL minimum clearance latch for side-by-side wall rackmounting



LED Temperature Display

- Fits Decora® knockout taking up zero rackspace pg. 224



economical pivoting wall cabinet

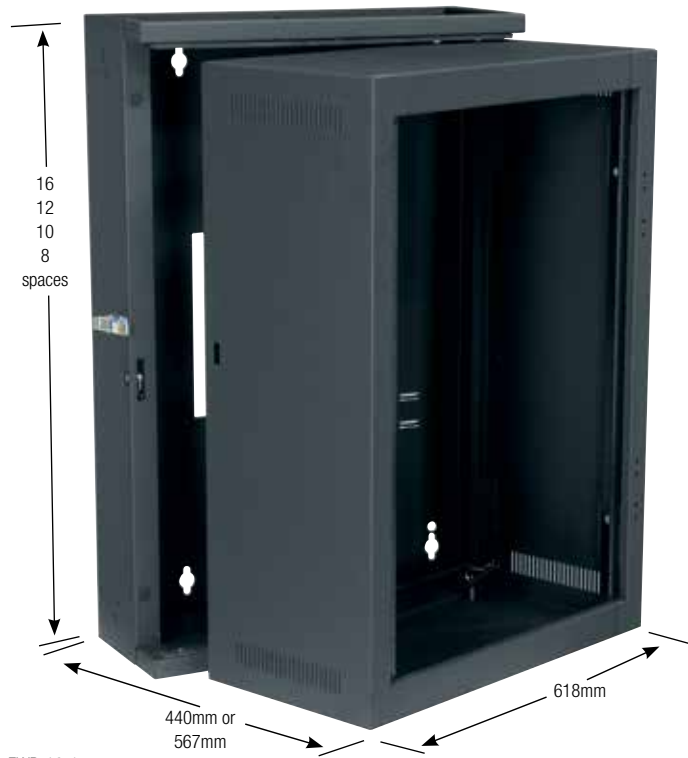

EWR-16-17



The **EWR Series** provides access to rear equipment connections for medium to small systems at an aggressive price.

- Fully welded construction for strength
- Patented Tool Free Quick-Mount™ system for center section mounting
- Center section swing is reversible, and can be both keylocked and padlocked
- Center section is keyed differently from optional front door for security
- Optimized for passive thermal management

Certifications

- RoHS
- GREENGUARD
- UL2416

Market Solutions



Broadcast



Commercial AV



Residential AV



Security



Structured Cabling



Education



Product Information

Part #	Fully Assembled with Solid Front Door Part #	Racking Height	Overall Height	Useable Depth	Overall Depth	Overall Width*	Weight Capacity
EWR-8-17	EWR-8-17SD	356mm (8 space)	533mm	381mm	440mm	618mm	68 kg
EWR-8-22	EWR-8-22SD	356mm (8 space)	533mm	508mm	567mm	618mm	68 kg
EWR-10-17	EWR-10-17SD	445mm (10 space)	622mm	381mm	440mm	618mm	68 kg
EWR-10-22	EWR-10-22SD	445mm (10 space)	622mm	508mm	567mm	618mm	68 kg
EWR-12-17	EWR-12-17SD	533mm (12 space)	711mm	381mm	440mm	618mm	68 kg
EWR-12-22	EWR-12-22SD	533mm (12 space)	711mm	508mm	567mm	618mm	68 kg
EWR-16-17	EWR-16-17SD	711mm (16 space)	889mm	381mm	440mm	618mm	68 kg
EWR-16-22	EWR-16-22SD	711mm (16 space)	889mm	508mm	567mm	618mm	68 kg

Accessory Bundles

- Equipped with multipacks of system essentials & available in 3 sizes, see pg. 129

Options

Please visit our website for more info.

Fits Part #	Front Doors				Additional 10-32 Threaded Rackrail	Rackrail Bracket Extender*
	Solid	Plexi	64% Open Area Perf	Partially Vented		
EWR-8-17	FD-8	PFD-8	LVFD-8	EVFD-8	DWR-RR8	EWR-ARB-17
EWR-8-22	FD-8	PFD-8	LVFD-8	EVFD-8	DWR-RR8	EWR-ARB-22
EWR-10-17	FD-10	PFD-10	LVFD-10	EVFD-10	DWR-RR10	EWR-ARB-17
EWR-10-22	FD-10	PFD-10	LVFD-10	EVFD-10	DWR-RR10	EWR-ARB-22
EWR-12-17	FD-12	PFD-12	LVFD-12	EVFD-12	DWR-RR12	EWR-ARB-17
EWR-12-22	FD-12	PFD-12	LVFD-12	EVFD-12	DWR-RR12	EWR-ARB-22
EWR-16-17	FD-16	PFD-16	LVFD-16	EVFD-16	DWR-RR16	EWR-ARB-17
EWR-16-22	FD-16	PFD-16	LVFD-16	EVFD-16	DWR-RR16	EWR-ARB-22

*allows fully adjustable rail



swing open wall cabinet



The **CWR Series** is designed for structured cabling/high cable capacity.



CWR-26-22PD

- Welded steel construction for strength
- 660mm width provides extra space for cables and patching
- Comes standard with adjustable wide-face rackrail
- Locking swing open center section for front and rear access
- Includes a locking/latching plexi front door for added security
- Front door can be easily reversed for left or right hand swing
- Engineered for passive thermal management; optional fan kit available
- Bag of 50 mounting screws included
- Includes vertical cable rings

Certifications

- UL Listed
- RoHS
- GREENGUARD
- UL2416

Market Solutions



Broadcast



Commercial
AV



Residential
AV



Security



Structured
Cabling



Education



International
Fan Available



CWR racks and offset rail kits come with D-Ring managers for additional cable management



Product Information

Includes Plexi Door Part #	Racking Height	Overall Height	Useable Depth	Overall Depth w/o Door	Overall Width*	Weight Capacity
CWR-12-17PD	533mm (12 space)	632mm	381mm	432mm	660mm	91 kg
CWR-12-22PD	533mm (12 space)	632mm	508mm	559mm	660mm	91 kg
CWR-12-26PD	533mm (12 space)	632mm	610mm	660mm	660mm	91 kg
CWR-12-32PD	533mm (12 space)	632mm	762mm	813mm	660mm	91 kg
CWR-18-17PD	800mm (18 space)	899mm	381mm	432mm	660mm	91 kg
CWR-18-22PD	800mm (18 space)	899mm	508mm	559mm	660mm	91 kg
CWR-18-26PD	800mm (18 space)	899mm	610mm	660mm	660mm	91 kg
CWR-18-32PD	800mm (18 space)	899mm	762mm	813mm	660mm	91 kg
CWR-26-17PD	1156mm (26 space)	1254mm	381mm	432mm	660mm	91 kg
CWR-26-22PD	1156mm (26 space)	1254mm	508mm	559mm	660mm	91 kg
CWR-26-26PD	1156mm (26 space)	1254mm	610mm	660mm	660mm	91 kg
CWR-26-32PD	1156mm (26 space)	1254mm	762mm	813mm	660mm	91 kg

*not including latch

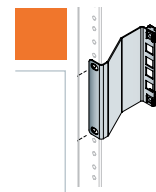

Installation Helper

- Recess rackmount equipment 76mm to make room for cables pg. 244

Options

Please visit our website for more info.

Fits Part #	Description
CWR-FKIT	fan kit, 2 (95CFM) fans w/ hardware
CWR-RR12	rear rail kit, 12 space, centered for CWR Series
CWR-RR18	rear rail kit, 18 space, centered for CWR Series
CWR-RR26	rear rail kit, 26 space, centered for CWR Series
CWR-OFRR12*	12 space off-set rail kit w/ D-Rings for CWR Series
CWR-OFRR18*	18 space off-set rail kit w/ D-Rings for CWR Series
CWR-OFRR26*	26 space off-set rail kit w/ D-Rings for CWR Series

*allows 483mm EIA mounting width to be shifted to the left or right of the 660mm width CWR enclosure to allow for large cable bundles on one side

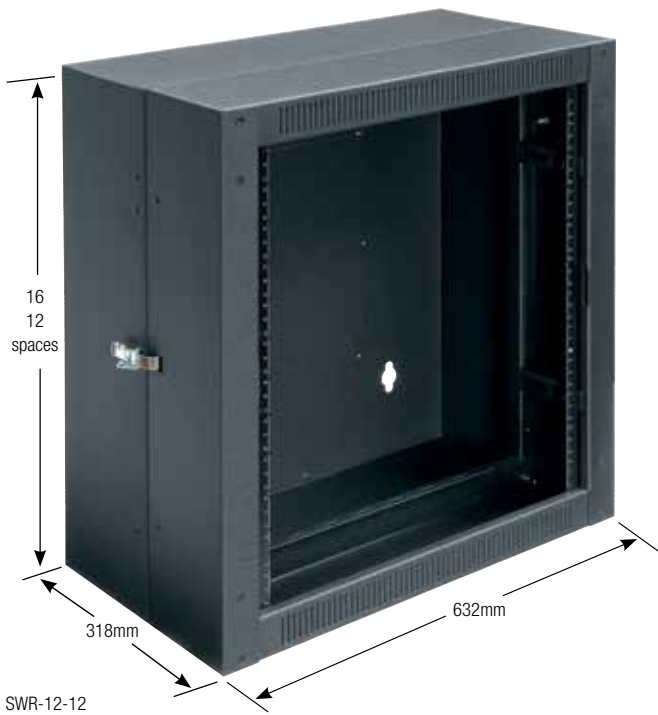

shallow pivoting versatile wall cabinet



The **SWR Series** is ideal for wall mounting interconnect panels.

- Front section can be easily reversed for left or right hand swing
- Latch can be mounted top or bottom to allow side-by-side mounting
- Backpan features conduit entry laser knockouts at the top and bottom
- Standard front adjustable 10-32 threaded rackrail with # spaces

Certifications

- RoHS
- GREENGUARD
- UL2416

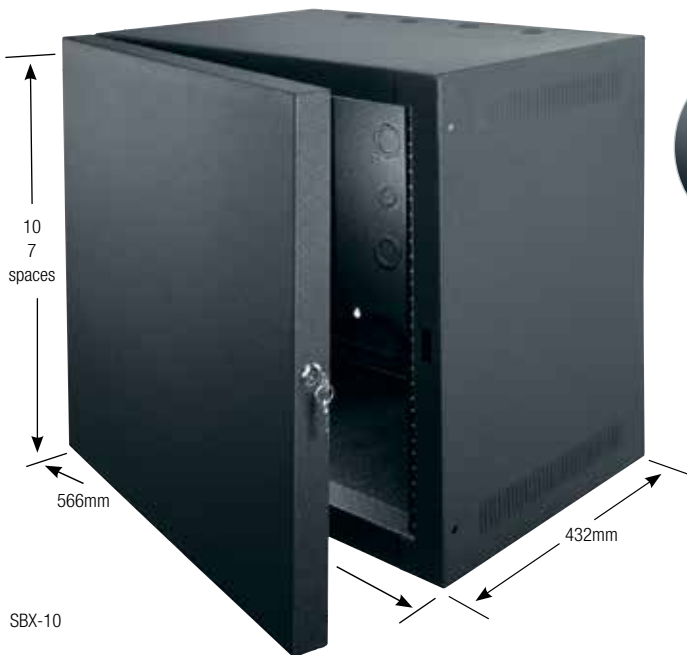

economical fixed wall rack



The **SBX Series** is ideal for use when seeking an economical solution for wall mounting smaller systems.

- Removable backpan simplifies installation
- Includes locking front door that swings open a full 180° on a rugged hinge
- Ventilation slots on each side promote passive thermal management accepts optional fans for active thermal management
- Laser and electrical knockouts at top, bottom, and rear for cable pass-through
- Standard heavy-gauge, 10-32 threaded rackrail with marked spaces

Certifications

- RoHS
- GREENGUARD
- UL2416



Product Information

Part #	Racking Height	Overall Height	Useable Depth	Overall Depth	Overall Width	Weight Capacity
SWR-12-12	533mm (12 space)	638mm	302mm	318mm	632mm	68 kg
SWR-16-12	711mm (16 space)	816mm	302mm	318mm	632mm	68 kg

Door Options

Solid Part #	Plexi Part #	25% Open Area Perf Vented Part #	64% Open Area Perf Vented Part #	# of Rackspaces
FD-12	PFD-12	VFD-12	LVFD-12	12
FD-16	PFD-16	VFD-16	LVFD-16	16

Market Solutions



Installation Tip

- When space is a premium, swap out cords to precise length needed
- Saves space & promotes proper airflow, see pg. 185

Product Information

Part #	Racking Height	Useable Depth	Weight Capacity
SBX-7	311mm (7 space)	375mm	34 kg
SBX-10	445mm (10 space)	375mm	45 kg

Options

Part #	Description
SBX-FAN-K	119mm low-profile fan for sbx series, 57 cfm (120 vac) cord, hardware, guards and vent blocker included

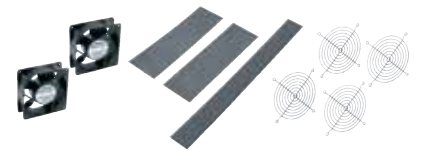

Market Solutions



Power Solutions



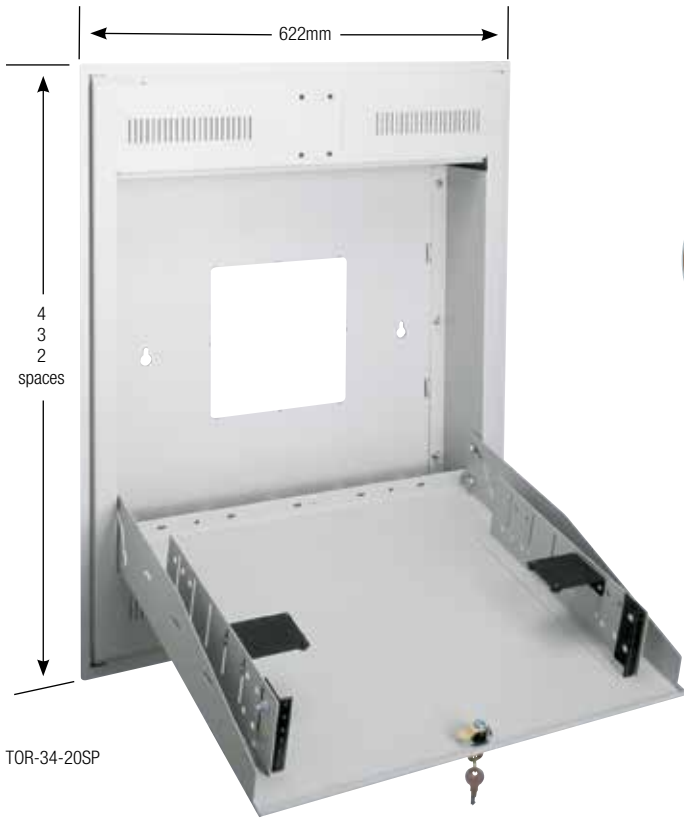

tilt out wall out



The **TOR Series** is ideal for small sound systems, paging and patching applications.

- Mounts between studs, flush with wall surface
- Tamper resistant design ideal for use in non-secure areas
- Mount non-rackmount equipment using included clamp bars
- 10-32 threaded rackrail is adjustable to accommodate handles & knobs
- Vented for effective passive thermal management
- Decora® and UCP knockouts provided to mount connectors & devices
- 45 kg weight capacity

Certifications

- RoHS
- GREENGUARD
- UL2416



low-profile wall mount cabinet



The **WRS/WRP Series** is ideal for vertically mounting equipment on a wall surface in a protective enclosure.

- Holds equipment up to 276mm deep in a vertical fashion
- Hinged, angled plexiglass (on WRP Series) or solid top (on WRS Series) cover allows user access to controls
- Body swing can be set to either right or left
- Both cover and body are lockable and keyed separately for security
- Vented for passive cooling, accepts optional fans if needed
- Available in putty or black finishes
- 68 kg weight capacity

Certifications

- RoHS
- GREENGUARD
- UL2416



Product Information

Surface Mount Part #	Flush Mount Part #	Racking Height	Outside Depth
TOR-2-20SP	TOR-2-20RP	89mm (2 space)	113mm
TOR-3-20SP	TOR-3-20RP	133mm (3 space)	157mm
TOR-4-20SP	TOR-4-20RP	178mm (4 space)	202mm

Options

Please visit our website for more info.

Part #	Description	Fits
TOR-PRT	trim kit for partial recess, allows mounting between 2x4 studs	TOR-3-20RP or TOR-4-20RP

Market Solutions



Product Information

Putty Part #*	Black Part #**	Racking Height
WRP-4	WRS-4	178mm (4 space)
WRP-6	WRS-6	267mm (6 space)
WRP-8	WRS-8	356mm (8 space)

*Putty version has plexi cover, black version has solid cover.

Market Solutions



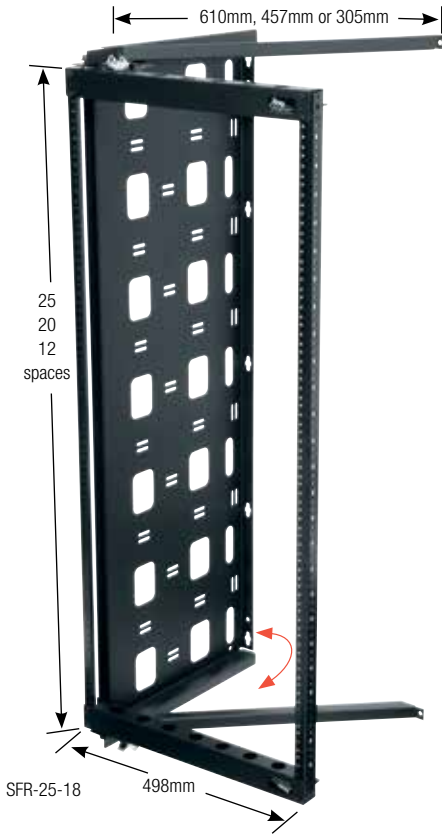

swing frame wall rack



The **SFR Series** is ideal for patch panels, hubs, switches and other network equipment in a secure room or closet.

- Rugged steel construction provides the greatest strength in its class
- Unique design uses pivot points and can be inverted left or right swing
- Open-back design maximizes useable wall space
- 90° opening with positive stop for punching down
- Ready-to-assemble design allows for flat shipment via UPS
- Standard 10-32 threaded rackrail with marked spaces

Certifications

- RoHS
- GREENGUARD

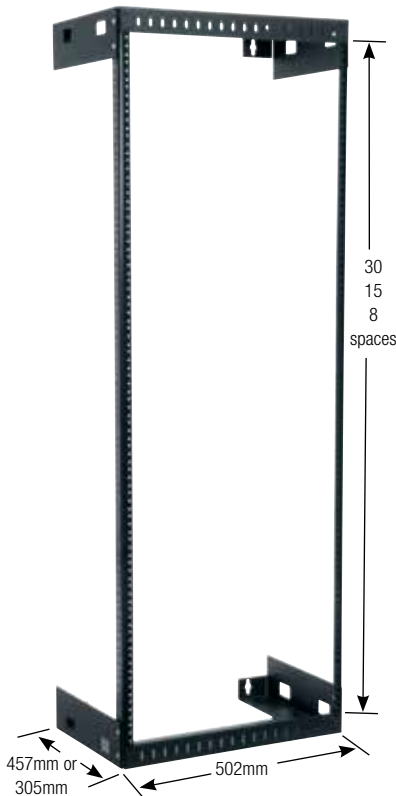

open frame wall mount rack



The **WM Series** is designed for quick and easy assembly, self squaring wall mount rack for all types of components.

- Rugged steel construction
- Ready-to-assemble design allows for flat shipment via UPS
- Self-aligning design for fast assembly
- 10-32 threaded rackrail
- Includes rack screws

Certifications

- RoHS
- GREENGUARD

WM-30-12



Product Information

305mm Depth Part #	457mm Depth Part #	610mm Depth Part #	Racking Height	Overall Height	Weight Capacity
SFR-12-12	SFR-12-18	SFR-12-24	533mm (12 space)	692mm	45 kg
SFR-20-12	SFR-20-18	SFR-20-24	889mm (20 space)	1048mm	45 kg
-	SFR-25-18	SFR-25-24	1111mm (25 space)	1270mm	45 kg



For additional cable management options

- Vertical cable management pg. 214
- Horizontal cable management pg. 210

Market Solutions



Product Information

Part #	Overall Height	Racking Height	Depth	Weight Capacity
WM-8-12	451mm	356mm (8 space)	305mm	91 kg
WM-8-18	451mm	356mm (8 space)	457mm	68 kg
WM-15-12	762mm	667mm (15 space)	305mm	91 kg
WM-15-18	762mm	667mm (15 space)	457mm	68 kg
WM-30-12	1429mm	1334mm (30 space)	305mm	134 kg
WM-30-18	1429mm	1334mm (30 space)	457mm	111 kg

Market Solutions





low-profile horizontal distribution cabinet

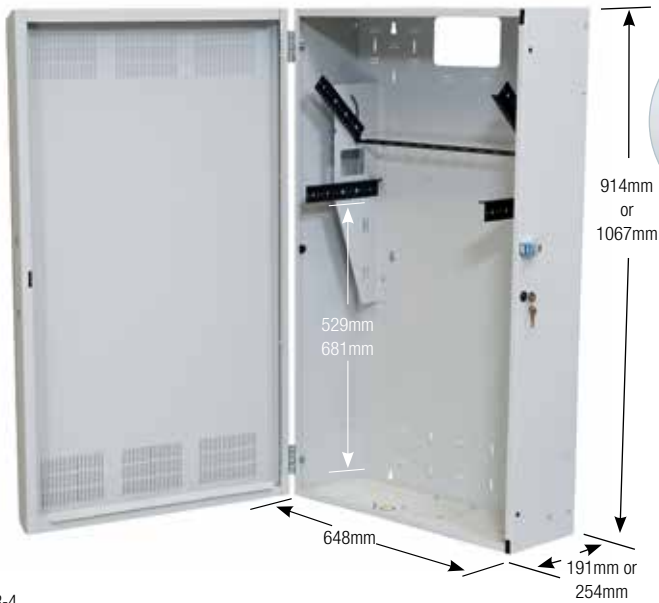

HDR-4



The **HDR Series** is ideal for a secure way to wall mount of structured cabling systems.

- Provides two equipment areas
- Upper bay mounts patch panels and pivots 100° with stop for punch-downs
- Lower bay mounts switches and routers and pivots 15° for access to connections
- Beveled front door with flanges on all sides for increased security
- Hinged door is reversible and vented, with lock and padlockable latch
- Laser knockouts on the top, bottom and sides for cable entry
- 68 kg weight capacity

Certifications

- UL/ETL Listed
- RoHS
- GREENGUARD
- UL2416

versa-rack sideways mounting system



The **SPM Series** is designed to mount equipment on the wall vertically, under table or sideways.

- Rugged steel construction
- Abundant rear cable lacing points
- 10-32 threaded rackrail is adjustable to 3 positions to accommodate D-Ring cable managers
- Includes rack screws

Certifications

- UL/ETL Listed
- RoHS
- GREENGUARD



SPM-4



Product Information

Part #	Overall Height	Racking Height	Overall Width	Useable Depth
HDR-4	914mm	89mm + 89mm (2 rackspace + 2 rackspace)	648mm	529mm
HDR-9	914mm	178mm + 222mm (4 rackspace + 5 rackspace)	648mm	529mm
HDR-9X	1067mm	178mm + 222mm (4 rackspace + 5 rackspace)	648mm	681mm

Options

Please visit our website for more info.

Part #	Racking Height
HDR-FAN	external 119mm fan kit & vent blocker

Market Solutions



Power Solutions



Product Information

Part #	Racking Height	Weight Capacity
SPM-2	89mm (2 space)	23 kg
SPM-4	178mm (4 space)	18 kg

Market Solutions





VPM-4

vertical panel panel mount



The **VPM Series** is ideal for applications where a protective enclosure is not required.

- Accommodates all depths of equipment
- Heavy duty 10-32 threaded rackrail
- Use two to provide 4-point mounting
- Includes hole for safety screw (for under desk mounting)
- 91 kg weight capacity

Certifications

- RoHS
- GREENGUARD

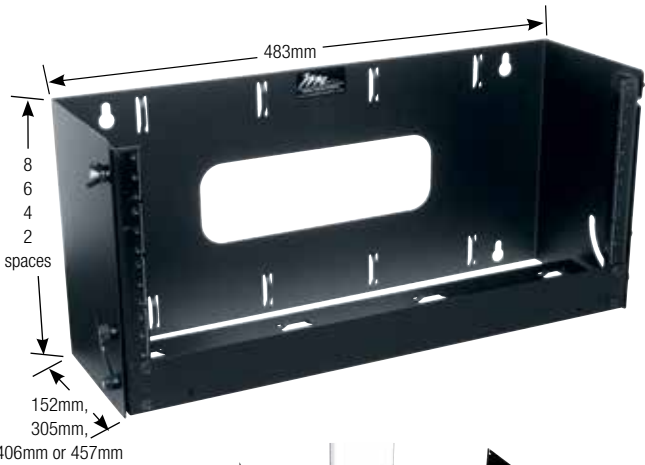

PPM-4

pivoting panel mount



The **PPM Series** is designed for rear access of patch panels and network equipment with 90° positive stop drop down.

- Open back design for wall obstructions such as conduits or raceways
- Abundant internal tie points for cable management
- Standard 10-32 threaded rackrail
- Includes hook and loop cable fasteners and rack screws
- Optional security covers and doors available

Certifications

- RoHS
- GREENGUARD



PPM-6-160B



Product Information

Part #	Racking Height
VPM-2	89mm (2 space)
VPM-3	133mm (3 space)
VPM-4	178mm (4 space)

Market Solutions



Product Information

Part #	Backless PPM Part #	Security Top Cover Part #	Security Door Part #	Racking Height	Overall Height	Depth	Weight Capacity
PPM-2	–	–	–	89mm (2 space)	146mm	152mm	9 kg
PPM-4	–	–	–	178mm (4 space)	235mm	152mm	9 kg
PPM-6	–	–	–	267mm (6 space)	324mm	152mm	14 kg
PPM-6-12	–	PPM-LID12	PPM-D06*	267mm (6 space)	324mm	305mm	18 kg
–	PPM-6-160B	PPM-LID16	PPM-D06*	267mm (6 space)	324mm	406mm	18 kg
PPM-8-12	–	PPM-LID12	PPM-D08*	356mm (8 space)	413mm	305mm	27 kg
PPM-8-18	–	PPM-LID18	PPM-D08*	356mm (8 space)	413mm	457mm	27 kg

*When using door option, top cover is required

Additional Options:



PPM-D08 security door



PPM-LID16 lid, fits 406mm deep PPMs

Market Solutions



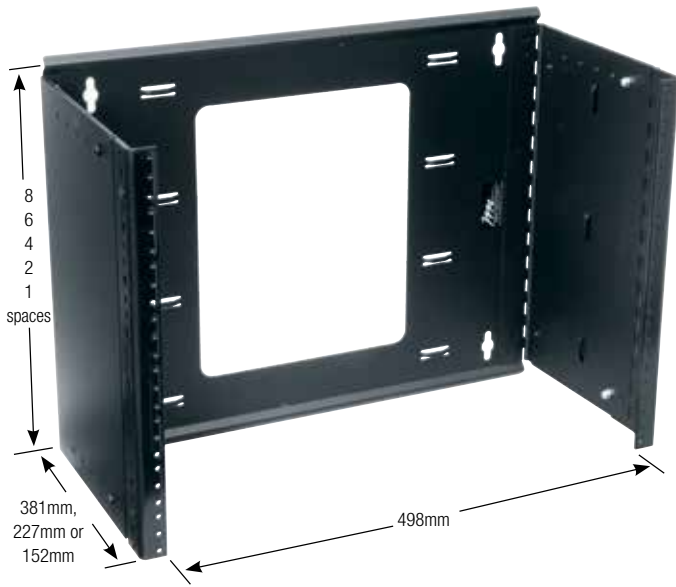

HPM-8-915

hinged panel mount



The **HPM Series** provides simple wall mounting of components and can be rackmounted to any 483mm open frame rack.

- Rugged steel construction
- Hinged to provide rear access to mounted components
- Universal keyhole mounting for left or right swing
- Standard 10-32 threaded rackrail
- Optional dust cover/modem shelf is available
- Includes rack screws and hook & loop fasteners

Certifications

- RoHS
- GREENGUARD



VLBX

lockbox wall mount



The **DLBX/VLBX Series** is designed to keep digital recording equipment secure in open public spaces or other unsecure locations.

- Optimized for active or passive thermal management
- Wall mounts vertically or horizontally, can also be used as a monitoring shelf
- Extensive cable management tie points, electrical knockouts and cable pass-throughs
- Interlocking top for added security; top removes easily for servicing
- Standard keylocked vented hinging front door, two fans

Certifications

- RoHS
- GREENGUARD



DLBX-FSK security cover kit prevents tampering with equipment while keeping airflow



Product Information

Part #	Racking Height	Hinge Type	Depth	Adjustable Depth	Weight Capacity
HPM-1	44mm (1 space)	single	152mm	fixed - 152mm	-
HPM-2	89mm (2 space)	single	152mm	-	-
HPM-4	178mm (4 space)	single	152mm	-	-
HPM-4-915	178mm (4 space)	double	152mm	229mm - 381mm	7 kg
HPM-6	267mm (6 space)	single	152mm	-	-
HPM-6-915	267mm (6 space)	double	152mm	229mm - 381mm	9 kg
HPM-8-915	356mm (8 space)	double	152mm	229mm - 381mm	11 kg

Options

Please visit our website for more info.

Part #	Racking Height
HPM-LID	top dust cover acts as an equipment shelf for 152mm HPM only

Market Solutions



Product Information

Part #	Description	Inside Dimensions	Outside Dimensions
DLBX	DVR/NVR lockbox w/ fan	581mm w x 279mm h x 679mm d	606mm w x 294mm h x 718mm d
VLBX	DVR lockbox w/ fan	524mm w x 203mm h x 527mm d	527mm w x 206mm h x 530mm d
VBLX-5.5	DVR lockbox w/ fan	505mm w x 137mm h x 432mm d	508mm w x 140mm h x 438mm d

Options

Please visit our website for more info.

Part #	Description
DLBX-WM	pair of wall mount brackets for DLBX
VLBX-WM	pair of wall mount brackets for VLBX only (not compatible with VLBX-5.5)
DLBX-RR5	10-32 threaded rackrail kit for DLBX, 5 space with cutouts for cable pass-through
DLBX-FSK	security cover kit for DLBX
FC-2-215-1CA	proportional speed thermostatic fan control with two 15 Amp outlets for DLBX

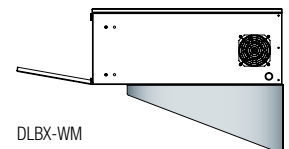

DLBX-WM

Market Solutions



Power Solutions





slide out racks

Slide out racks, pioneered by Middle Atlantic Products, solve a common challenge by providing rear access to equipment and connections where a rear open aisle is not possible.

They are ideal for cramped utility spaces, systems built into residential or commercial millwork and small systems in AV furniture.



All styles have robust weight capacities and pull forward to provide rear access; some styles also rotate to further increase accessibility.

Installation by Intra Home Systems.

WR Series	80 - 81
AXS Series	82 - 85
AX-SXR Series	86 - 87
ASR-HD Series	88 - 89
ASR and REB Series	90 - 91
SRSR and SRS Series	92 - 93



roll out rotating system



The **WR Series** provides secure rear access to equipment connections for larger audio, video and security equipment installations.

- Host enclosure can be pre-installed on-site
- Detachable rack frame can be integrated with equipment and tested off-site
- Requires no additional accessories to roll out and rotate
- Engineered ventilation is optimized for passive thermal management
- Rack frame features built-in cable management tie points
- 102mm laser knockouts provided for cable pass-through and ganging multiple racks
- Standard front and rear 10-32 threaded rackrail with marked spaces
- Frame locks in closed position



Thermal Top Options pg. 46

- 240V Fans pg. 226
- Fan Controller pg. 130

Certifications

- UL/ETL Listed
- RoHS
- GREENGUARD

Market Solutions



Broadcast



Commercial
AV



Residential
AV



Security



Structured
Cabling



Education



International
Fan Available



Product Information

Part #	Overall Depth	Useable Depth	Useable Racking Height
WR-24-32	835mm	660mm	1067mm (24 space)
WR-37-32	835mm	660mm	1645mm (37 space)
WR-37-42	1089mm	914mm	1645mm (37 space)
WR-44-32	835mm	660mm	1956mm (44 space)
WR-44-42	1089mm	914mm	1956mm (44 space)

Options

Please visit our website for more info.

Fits Part #	76mm Deep Solid Front Door*	76mm Deep Plexi Front Door*	Additional Threaded Rackrail	Rear Access Panel
WR-24-xx	WRFD-24	WRPFD-24	WR-RR-24	WR-RAP-24
WR-37-xx	WRFD-37	WRPFD-37	WR-RR-37	WR-RAP-37
WR-44-xx	WRFD-44	WRPFD-44	WR-RR-44	WR-RAP-44

*Doors provide 76mm clearance from face of front rail. NOTE: When multiple units are installed and doors swing the same way, additional cable chase is required for door opening clearance.



space-saving design



The **AXS Series** allows the rack frame to pull straight out for rear access to equipment in millwork or in-wall applications.

- Unique interlocking corner joint for exceptional strength and easy assembly
- Removable rack frame can be integrated off-site to save time
- Articulating cable carriers provide effective cable management
- Standard fixed front and rear 10-32 threaded rackrail
- Service stand raises service tracks to bottom of AXS, allowing it to pull out
- Service tracks include built-in level to save time

Certifications

- RoHS
- GREENGUARD

Market Solutions



Broadcast



Commercial AV



Residential AV



Security



Structured Cabling



Education



International Fan Available

Power Solutions



100VAC – 2240VAC | 50/60Hz Compatible



Product Information

Part #		Ext. Length	Frame Depth	Weight Capacity	Rough Opening Width	Rough Opening Width When Using Gasket & Guide Kit	Rotating
AXS-xx-26	xx equals # of useable space (15 to 43 space)	1219mm	660mm	295 kg	489mm	499mm	no
AXS-xx	xx equals # of useable space (15 to 43 space)	1219mm	508mm	295 kg	489mm	499mm	no
AX-SX-xx	xx equals # of useable space (10 to 43 space)	635mm	508mm	295 kg	489mm	499mm	no
SAX-xx	xx equals # of useable space (15 to 43 space)	1219mm	419mm	295 kg	489mm	499mm	no
SSAX-xx	xx equals # of useable space (15 to 43 space)	635mm	419mm	295 kg	489mm	499mm	no

Service Tracks* - pair of removable service tracks			
Part #	Use With	Track Length	Rack Frame Ext. Depth
TRACK25	AX-SX, SSAX	635mm	635mm
TRACK50	AXS, SAX, AXS-xx-26	1270mm	1219mm

Service Stands* - removable telescoping stand that supports & levels the service tracks			
Part #	Height Range Off the Floor	Part #	Height Range Off the Floor
TS310	76mm to 125mm	TS1640	406mm to 1016mm



Complete The Look

- RSH custom rackshelves pg.190

Options

Please visit our website for more info.

Part #	Description	Fits
AXS-FAN	1 slim fan, 57 CFM	AX-SXR
AXS-FAN-K	2 slim fans, 114 CFM	AX-SXR
AXS-GG16	gasket and guide kit	406mm deep AXS
AXS-GG20	gasket and guide kit	508mm deep AXS,
AXS-GG26	gasket and guide kit	660mm deep AXS
AXS-TEXTTRIM	trim panel textured finish	any AXS
AXS-WT50	cable management tray	AXS, SAX
AXS-WT25	cable management tray	AX-SX, SSAX
BG17	5182mm brush gasket	any AXS

Additional Options:



AXS-FAN-119
top accepts up to 2 fans



AXS-TEXTTRIM
trim panel



AXS-WT50
cable management tray



MRK-4026AXS-Z4

factory-assembled system



The **AXS Series** design allows entire bays of equipment to roll straight out for service and installation flexibility.

- Host enclosure can be pre-installed on-site
- Detachable rack frame can be integrated with equipment and tested off-site
- Service stand raises service tracks to bottom of AXS, allowing it to pull out
- Standard fixed front and rear 10-32 threaded rackrail with numbered spaces
- Includes articulating cable carriers for effective cable management
- System includes host cabinet, rack frame, cable carriers, base, and safety leashes
- Service tracks and stands sold separately

Certifications

- Seismic Certification
- RoHS
- GREENGUARD
- OSHPOD

Market Solutions



Power Solutions



100VAC – 2240VAC | 50/60Hz Compatible



Product Information

Part #	Useable Racking Height	Overall Height	Frame Depth	Host Cabinet Depth	Overall Width	Seismic Certified
MRK-4426AXS	1822mm (41 space)	2111mm	508mm	673mm	559mm	No
MRK-4026AXS	1645mm (37 space)	1934mm	508mm	673mm	559mm	No
MRK-3726AXS	1511mm (34 space)	1800mm	508mm	673mm	559mm	No
MRK-4431AXS-26	1822mm (41 space)	2111mm	660mm	800mm	559mm	No
MRK-4031AXS-26	1645mm (37 space)	1934mm	660mm	800mm	559mm	No
MRK-3731AXS-26	1511mm (34 space)	1800mm	660mm	800mm	559mm	No
MRK-4426AXS-Z4	1822mm (41 space)	2111mm	508mm	673mm	559mm	Yes
MRK-4026AXS-Z4	1645mm (37 space)	1934mm	508mm	673mm	559mm	Yes
MRK-3726AXS-Z4	1511mm (34 space)	1800mm	508mm	673mm	559mm	Yes
WRK-44SA-27AXS	1822mm (41 space)	2111mm	508mm	2191mm	616mm	No
WRK-44SA-32AXS-26	1822mm (41 space)	2111mm	660mm	826mm	616mm	No
ERK-4425AXS	1822mm (41 space)	2061mm	508mm	635mm	559mm	No
ERK-3525AXS	1422mm (32 space)	1661mm	508mm	635mm	559mm	No

Service Tracks* - pair of removable service tracks (not included)		
Part #	Track Length	Rack Frame Ext. Depth
TRACK50	1270mm	1219mm

Service Stands* - removable telescoping stand that supports & levels the service tracks	
Part #	Height Range Off the Floor
TRACKL	57mm to 83mm



Installation Helper

- EB1-H, blank panel with handles pg. 232

Options

Please visit our website for more info.

Fits Part #	Description	Fits
AXS-TEXTRIM	trim panel textured finish	any AXS
AXS-WT50	1270mm cable carrier wire tray	any AXS
BG17	5182mm brush gasket	any AXS

Additional Options:

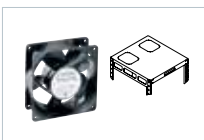

AXS-FAN-119
top accepts up to 2 fans



AXS-TEXTRIM
trim panel



AXS-WT50
cable management tray

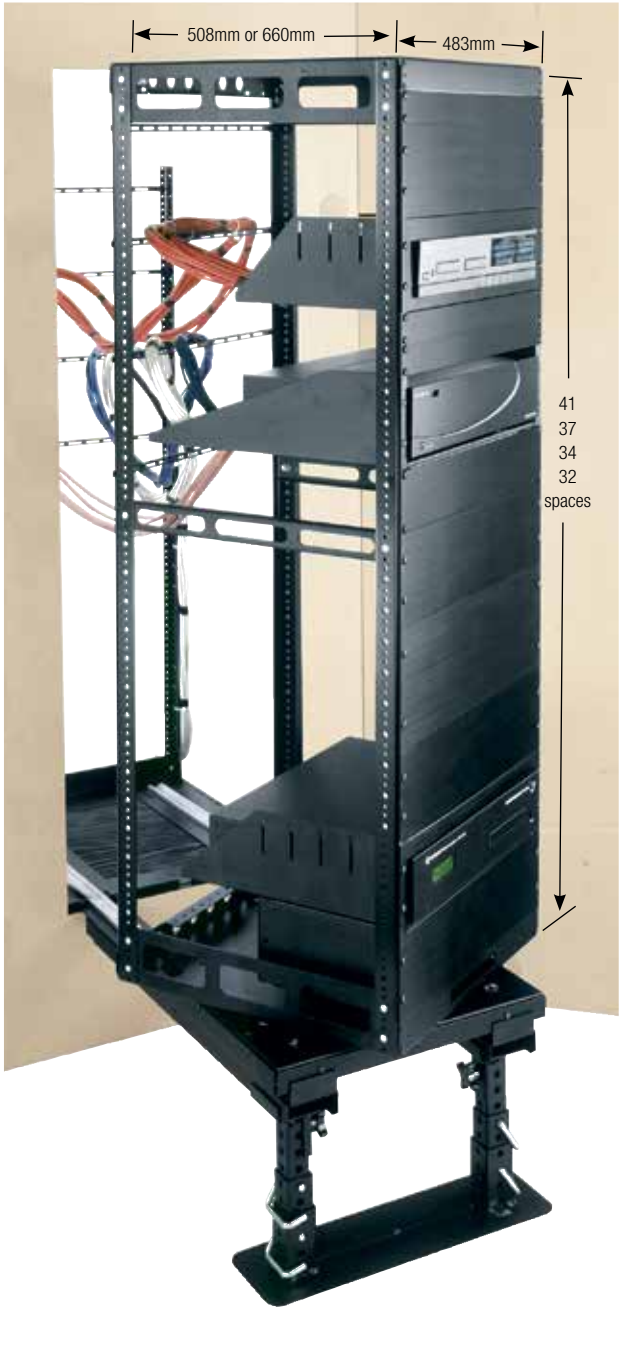

AX-SXR

in-wall slide out rotating rack



The **AX-SXR Series** pulls out from an in-wall installation, it also turns once pulled out to provide more access to equipment.

- Specify when installing audio and video equipment flush into a wall or cabinet
- Ideal for use in tight spaces with limited room to slide out the rack
- Unique interlocking corner joint for exceptional strength and easy assembly
- Removable rack frame can be integrated off-site to save time
- Standard fixed front and rear 10-32 threaded rackrail with numbered spaces
- Service stand raises service tracks to bottom of AXS, allowing it to pull out
- Service tracks include built-in level to save time

Certifications

- Seismic Certified
- UL/ETL Listed

Market Solutions



Broadcast



Commercial AV



Residential AV



Security



Structured Cabling



Education



International Fan Available

Power Solutions



100VAC – 2240VAC | 50/60Hz Compatible



Product Information

Part #		Ext. Length	Frame Depth	Weight Capacity	Rough Opening Width	Rough Opening Width When Using Gasket & Guide Kit
AX-SXR-xx	xx equals # of useable space (15 to 43 space)	787mm	508mm	204kg	489mm	499mm

Service Tracks* - pair of removable service tracks			
Part #	Use With	Track Length	Rack Frame Ext. Depth
TRACK31	AX-SXR	787mm	787mm

Service Stands* - removable telescoping stand that supports & levels the service tracks			
Part #	Height Range Off the Floor	Part #	Height Range Off the Floor
TS310	76mm to 279mm	TS1640	406mm to 1016mm



Options

Please visit our website for more info.

Fits Part #	Description	Fits
AXS-FAN-119	1 slim fan, 1.61 m ³ /m	AX-SXR
AXS-FAN-K-119	2 slim fans, 3.2 m ³ /m	AX-SXR
AXS-GG20	gasket and guide kit	AX-SXR
AXS-TEXTRIM	trim panel textured finish	any AXS
BG17	5182mm brush gasket	any AXS



ASR-60-HD

heavy-duty slide out rotating shelving system



The **ASR-HD Series** provides slide out and rotating functionality while enhancing access to rear equipment connections.

- Designed for more visible installations where aesthetics are important
- Shelves are simple to install and adjustable in 19mm increments
- Pulls out, rotates 60° in either direction and locks for easy access to connections
- Self-centering base speeds installation
- Ships fully assembled to save time
- Locking detent protects millwork
- Included cable management system facilitates a clean, organized installation
- Up to a 130 kg weight capacity depending on model

Certifications

- UL/ETL Listed
- RoHS
- GREENGUARD

Market Solutions



Broadcast



Commercial AV



Residential AV



Security



Structured Cabling



Education



International Fan Available



Product Information

Part #	Opening Height	Useable Depth	Weight Capacity	# of Shelves
ASR-30-HD	762mm	483mm	91 kg	4
ASR-42-HD	1067mm	483mm	91 kg	6
ASR-60-HD	1524mm	483mm	113kg	9



Application Tip

- For in cabinet installs, use ICABCOOL to keep system cool, pg. 225

Options

Please visit our website for more info.

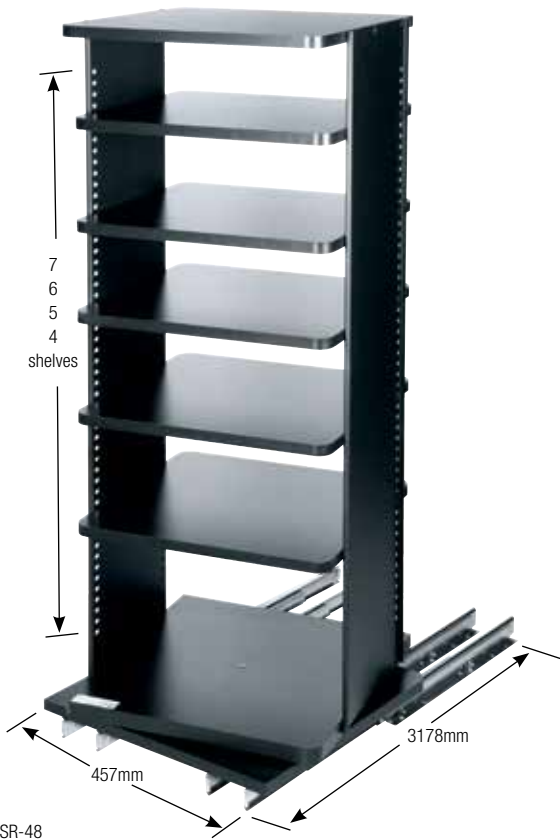

slide out rotating shelf



The **ASR Series** is ideal for smaller systems or when an open shelf system is desired.

- Provides enhanced access to rear equipment connections
- Self-leveling shelves are simple to install and are adjustable in 19mm increments
- Ready-to-assemble knockdown shipment
- Included cable management system facilitates a clean, organized installation

Certifications

- UL/ETL Listed
- RoHS
- GREENGUARD

slide out rotating base



The **REB Series** is designed for accessing cable and equipment connections.

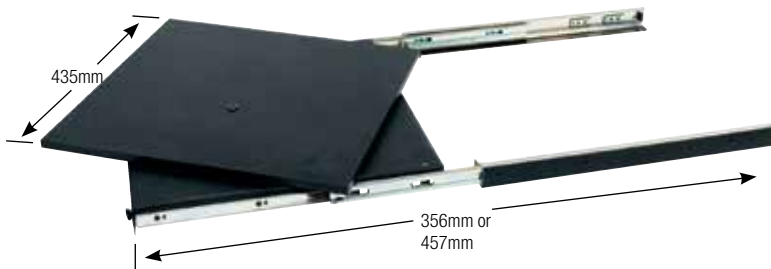

- Slides and rotates for easy access
- Two depths available
- Locks closed for safety
- Includes cable management system for a clean, organized installation

Certifications

- UL/ETL Listed
- RoHS
- GREENGUARD



Product Information

Part #	Opening Height	Overall Width	Useable Depth	Weight Capacity	# of Shelves
ASR-30	762mm	457mm	410mm	45 kg	4
ASR-36	914mm	457mm	410mm	45 kg	5
ASR-42	1067mm	457mm	410mm	91 kg	6
ASR-48	1219mm	457mm	410mm	91 kg	7

Market Solutions



Product Information

Part #	Min. Rough Opening Width*	Recommended Rough Opening Minimum Depth**	Weight Capacity	Useable Depth	
				With No Setback	With 25mm Setback
REB14	435mm	381mm	34 kg	330mm	305mm
REB18	435mm	483mm	34 kg	432mm	406mm

* Rough opening width will be extended by components wider than 432mm
 ** Rough opening depth will be increased by components deeper than the stated useable depth.

Market Solutions



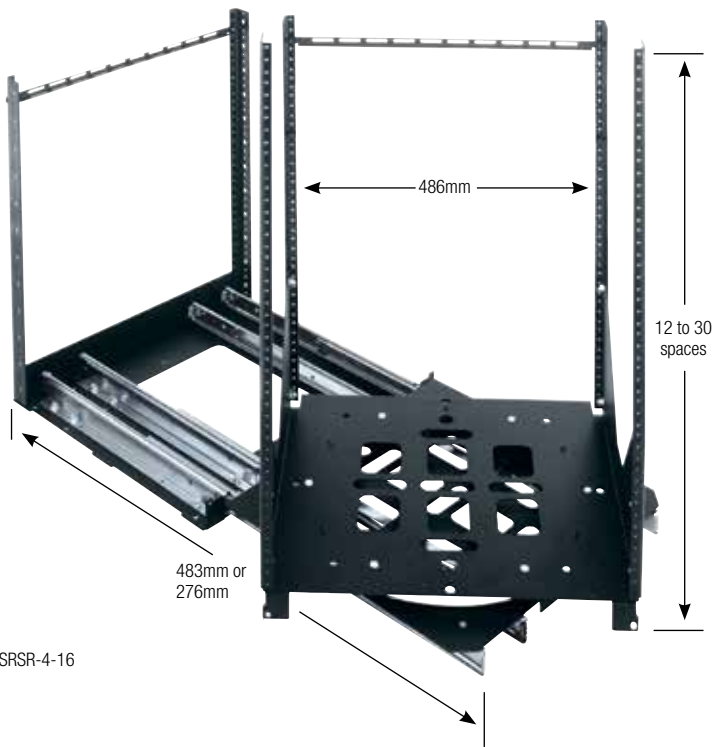

SRSR-4-16

slide out rotating shelf



The **SRSR Series** allows the rack frame to pull out and rotate for rear access to equipment in millwork or in-wall applications.

- Removable rack frame allows in-shop integration and on-site installation of equipment
- Locks in the extended position for simplified equipment integration
- Rotating equipment bay locks in place at 0°, 60° and 90° for easy installation and servicing
- Self-centering mounting base makes it simple to align system within cabinet opening
- Rear cable support works in conjunction with rear rackrail for effective cable management

Certifications

- UL/ETL Listed
- RoHS
- GREENGUARD

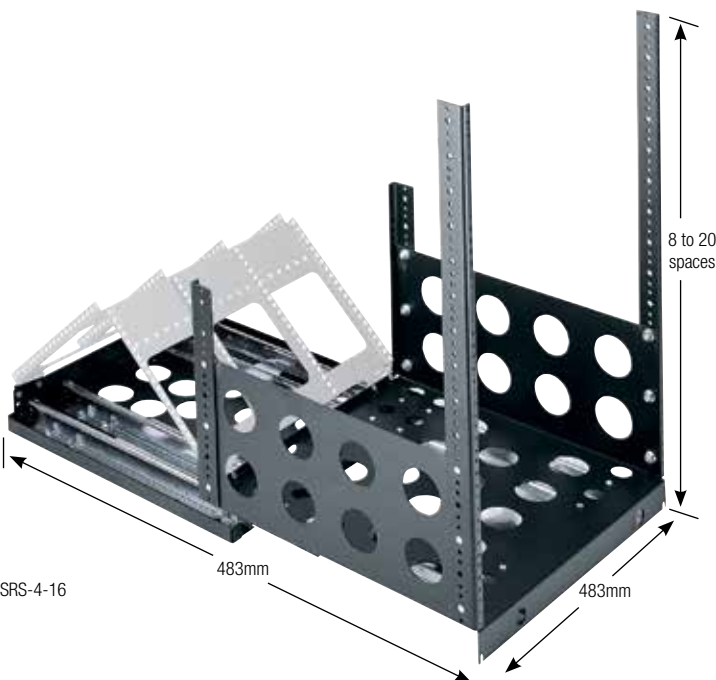

SRS-4-16

slide out rotating rail system



The **SRS Series** is designed for rear access to equipment connections in millwork and cabinets.

- System pulls out a full 483mm, providing rear access to equipment with shallow depths
- Trim panel secures unit closed
- Accepts optional triple-hinged, full-width cable carrier for additional cable management
- Standard front (8-20 spaces) and rear (7 space) 10-32 threaded rackrail with marked spaces

Certifications

- UL/ETL Listed
- RoHS
- GREENGUARD



Product Information

Part #	Description	Overall Depth
SRSR-2-xx (# of useable spaces, from 12 to 24)	2 slide 57 kg capacity	483mm
SRSR-4-xx (# of useable spaces, from 12 to 30)	4 slide 113 kg capacity	483mm
SRSR-X-xx (# of useable spaces, from 12 to 30)	4 slide 91 kg capacity	584mm



Application Tip

- For in cabinet installs, use ICABCOOL to keep system cool, pg. 225

Market Solutions



Product Information

Part #	Description
SRS2-xx (# of Useable spaces, from 8 to 20)	2 slide 57 kg capacity
SRS4-xx (# of Useable spaces, from 8 to 20)	4 slide 113 kg capacity

Options

Please visit our website for more info.

Part #	Description
SRCC	optional cable carrier
BG17	518mm brush gasket

Market Solutions





specialty racks

Middle Atlantic Products offers a wide range of equipment mounting solutions that were purpose-engineered for special installation challenges, and we call these models "Specialty Application Racks".

This section includes racks designed to roll from room to room, racks designed to fit into AV furniture, and more – even racks designed to hang from the ceiling.



Photo courtesy of Savant Experience Center.

And every solution features the same robust construction and attention to detail that you expect from Middle Atlantic.

We welcome your installation challenges – if you don't find a solution for your installation project needs, please call us for assistance.

MFR and RFR Series	96 - 97
RK/BRK, OBRK and MBRK Series	98 - 99
OSR and SRK Series	100 - 101
Slim 2 and DR Series	102 - 103
PTRK and ISRK Series	106 - 107
HRF Series	106 - 107
CFR Series	108 - 109
IDF and DTRK Series	110 - 111



MFR-2027GE

rugged and reliable



The **MFR Series** racks are engineered and rigorously tested to provide years of trouble-free service, these racks feature premium bolt-through casters and rigid construction for reliability.

- Cost-effective furniture rack
- Bolt-through casters (76mm) and internal steel bracing for strength (102mm casters on 20 space rack)
- Designed for passive cooling; optional fan kit is available
- Includes 10-32 threaded adjustable front rail
- Locking plexi front door is standard
- Ships fully assembled
- Optional flat screen mount holds most monitors up to 813mm

Certifications

- UL/ETL Listed
- RoHS
- GREENGUARD



RFR-2428TR

elegant mobility



The **RFR Reference Series** combines our most elegant design and highest reliability.

- Mobile presentation furniture rack, with wide, stable design
- Bolt-through casters (76mm) and internal steel bracing for strength
- Designed for passive cooling: optional blower kit is available
- Includes 10-32 threaded adjustable front rail
- Ships fully assembled
- Optional flat screen mount holds most monitors up to 813mm
- Efficient mounting Lever Lock™ system compatible (see pg. 206)

Certifications

- UL/ETL Listed
- RoHS
- GREENGUARD



Product Information

Part #	Overall Height	Racking Height	Overall Depth	Useable Depth
MFR-1227xx*	679mm	533mm (12 rackspace)	695mm	584mm
MFR-1627xx*	857mm	711mm (16 rackspace)	695mm	584mm
MFR-2027xx*	1067mm	889mm (20 rackspace)	695mm	584mm

* Replace 'xx' with KM = Knotted Maple, GE = Grained Ebony Ash, GC = Grained Dark Cherry.

Options

Rear Rackrail Kits*	Racking Height	Monitor Mount	(2) 76mm DC Fans, 50 CFM with Power Supply
MFR-RRK-12	533mm (12 rackspace)	MMB-1X1-12C pg. 144	MFR-FANKIT-2 pg. 226
MFR-RRK-16	711mm (16 rackspace)		
MFR-RRK-20	889mm (20 rackspace)		

* NOTE: you must order rear rail in the same size as your rack order.

Finishes

Please see pg. 249 for more info.

Market Solutions



Broadcast



Commercial
AV



Residential
AV



Security



Structured
Cabling



Education



International
Fan Available

Product Information

Part #	Overall Height	Racking Height	Overall Depth	Useable Depth
RFR-1628xx*	889mm	711mm (16 rackspace)	718mm	590mm
RFR-2028xx*	1067mm	889mm (20 rackspace)	718mm	590mm
RFR-2428xx*	1244mm	1067mm (24 rackspace)	718mm	590mm

* Replace 'xx' with BR = Black Rain, CR = Cherry Rain, TR = Teak Rain.

Options

Rear Rackrail Kits*	Racking Height	Monitor Mount	Lever Lock™ Mounts (2)**	Quiet DC Blower Panel 50 CFM, 29 dB
RFR-ERRK-16	711mm (16 rackspace)	MMB-1X1-12C pg. 144	LL-RFR	RFR-CABCOOL50 pg. 225
RFR-ERRK-20	889mm (20 rackspace)			
RFR-ERRK-24	1067mm (24 rackspace)			

* NOTE: you must order rear rail in the same size as your rack order. **Accommodates all 432mm vertical Lever Lock options.

Finishes

Please see pg. 49 for more info.

Market Solutions



Broadcast



Commercial
AV



Residential
AV



Security



Structured
Cabling



Education



International
Fan Available



laminate equipment racks



The **RK/BRK Series** are versatile equipment racks are offered with a variety of options for superior equipment mounting, casters and aesthetics.

- Superior equipment mounting, mobility and aesthetics
- Ready-to-assemble design allows for flat shipment via UPS
- Easy assembled with included hardware
- Includes 10-32 threaded front rackrail
- Available in black, maple or oak laminate finish

Certifications

- UL/ETL Listed
- RoHS
- GREENGUARD

Market Solutions



Broadcast



Commercial
AV



Residential
AV



Security



Structured
Cabling



Education



International
Fan Available



MBRK16



OBRK16



Product Information

	Series	Part #	Depth	Racking Height	Overall Height	Weight Capacity
Black Finisih	RK	RK2	406mm	89mm (2 space)	127mm	91 kg
		RK4	406mm	178mm (4 space)	216mm	91 kg
		RK6	406mm	267mm (6 space)	305mm	91 kg
		RK8	406mm	356mm (8 space)	394mm	91 kg
		RK10	406mm	445mm (10 space)	483mm	91 kg
		RK12	406mm	533mm (12 space)	572mm	91 kg
		RK14	406mm	2114mm (14 space)	660mm	91 kg
		RK16	406mm	711mm (16 space)	749mm	91 kg
		RK20	406mm	889mm (20 space)	927mm	91 kg
Black Finisih	BRK	BRK6	457mm	267mm (6 space)	305mm	91 kg
		BRK8	457mm	356mm (8 space)	394mm	91 kg
		BRK8-22	559mm	356mm (8 space)	394mm	91 kg
		BRK10	457mm	445mm (10 space)	483mm	91 kg
		BRK12	457mm	533mm (12 space)	572mm	91 kg
		BRK12-22	559mm	533mm (12 space)	572mm	91 kg
		BRK12-28	711mm	533mm (12 space)	572mm	91 kg
		BRK14	457mm	2114mm (14 space)	660mm	91 kg
		BRK16	457mm	711mm (16 space)	572mm	91 kg
		BRK16-22	559mm	711mm (16 space)	572mm	91 kg
		BRK16-28	457mm	711mm (16 space)	572mm	91 kg
		BRK20	457mm	889mm (20 space)	927mm	91 kg
		BRK20-22*	559mm	889mm (20 space)	927mm	223 kg
		BRK20-28*	711mm	889mm (20 space)	927mm	91 kg
BRK28-22*	559mm	4227mm (28 space)	1283mm	223 kg		
BRK28-28*	711mm	4227mm (28 space)	1283mm	91 kg		
Maple Finisih	MBRK	MBRK8	406mm	356mm (8 space)	394mm	91 kg
		MBRK8-22	559mm	356mm (8 space)	394mm	91 kg
		MBRK12	406mm	533mm (12 space)	572mm	91 kg
		MBRK12-22	559mm	533mm (12 space)	572mm	91 kg
		MBRK12-28	559mm	533mm (12 space)	572mm	91 kg
		MBRK16	406mm	711mm (16 space)	572mm	91 kg
		MBRK16-22	559mm	711mm (16 space)	572mm	91 kg
		MBRK16-28	711mm	711mm (16 space)	572mm	91 kg
		MBRK20	406mm	889mm (20 space)	927mm	91 kg
		MBRK20-22*	559mm	889mm (20 space)	927mm	223 kg
		MBRK20-28*	711mm	889mm (20 space)	927mm	223 kg
		MBRK28-22*	559mm	4227mm (28 space)	1283mm	223 kg
MBRK28-28*	711mm	4227mm (28 space)	1283mm	223 kg		
Oak Finisih	OBRK	OBRK8	457mm	356mm (8 space)	394mm	91 kg
		OBRK12	457mm	533mm (12 space)	572mm	91 kg
		OBRK16	457mm	711mm (16 space)	749mm	91 kg
		OBRK20	457mm	889mm (20 space)	927mm	91 kg

*ships LTL

Options

Please visit our website for more info.

Smoked Tempered Glass Door	Racking Height	Fits	Rear Access Panel Black Finish	Fits
RK-GD6	267mm (6 space)	all BRKs, MBRKs and OBRKs	—	all BRKs and MBRKs
RK-GD8	356mm (8 space)		RK-RAP8	
RK-GD10	445mm (10 space)		—	
RK-GD12	533mm (12 space)		RK-RAP12	
RK-GD14	622mm (14 space)		—	
RK-GD16	711mm (16 space)		RK-RAP16	
RK-GD20	889mm (20 space)		RK-RAP20	
RK-GD28	1245mm (28 space)		RK-RAP28	

Fan Kit with Energy Saving Thermostatic Control	Fits	Quick Position Shelf	Fits	Rear Rackrail Kits	Fits	Caster Kits (hardware incl.)	Fits
DC-FANKIT-4	559mm or deeper BRKs, MBRKs and OBRKs	SH-BRK (1) SH-BRK-3P (3)	457mm deep BRKs, MBRKs and OBRKs	RK-RRx (x=number of rackspaces)	all BRKs, MBRKs and OBRKs	RKW RKW-HD	all BRKs, MBRKs and OBRKs

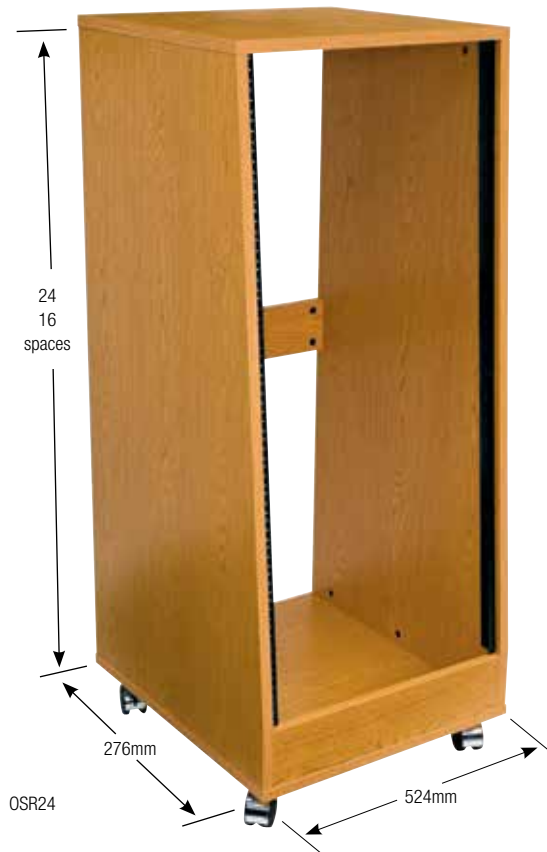

sloped oak rolling rack



The **OSR Series** versatile equipment racks are offered with a variety of options for superior equipment mounting, casters and aesthetics.

- Gently sloped (5°) rack face to facilitate equipment viewing
- Ready-to-assemble design allows for flat shipment via UPS
- Sturdy 19mm oak laminate construction
- Includes pre-installed heavy-gauge 10-32 threaded front rackrail
- Includes casters
- Oak finish and 91 kg weight capacity

Certifications

- UL/ETL Listed
- RoHS
- GREENGUARD



sloped rolling equipment rack



The **SRK Series** versatile equipment racks are offered with a variety of options for superior equipment mounting, casters and aesthetics.

- 16 vertical rackspaces at bottom, with 12 sloped rackspaces on top for easy visibility
- Ready-to-assemble design allows for flat shipment via UPS
- Includes pre-installed heavy-gauge 10-32 threaded front rackrail
- Includes factory-installed casters

Certifications

- UL/ETL Listed
- RoHS
- GREENGUARD



Product Information

Part #	Racking Height	Depth at Top	Overall Height
OSR16	711mm (16 space)	495mm	927mm
OSR24	1067mm (24 space)	495mm	1283mm

Market Solutions

- 
Broadcast
- 
Commercial AV
- 
Residential AV
- 
Security
- 
Structured Cabling
- 
Education
- 
International Fan Available

Product Information

Part #	Weight Capacity
SRK	91 kg

Market Solutions

- 
Broadcast
- 
Commercial AV
- 
Residential AV
- 
Security
- 
Structured Cabling
- 
Education
- 
International Fan Available

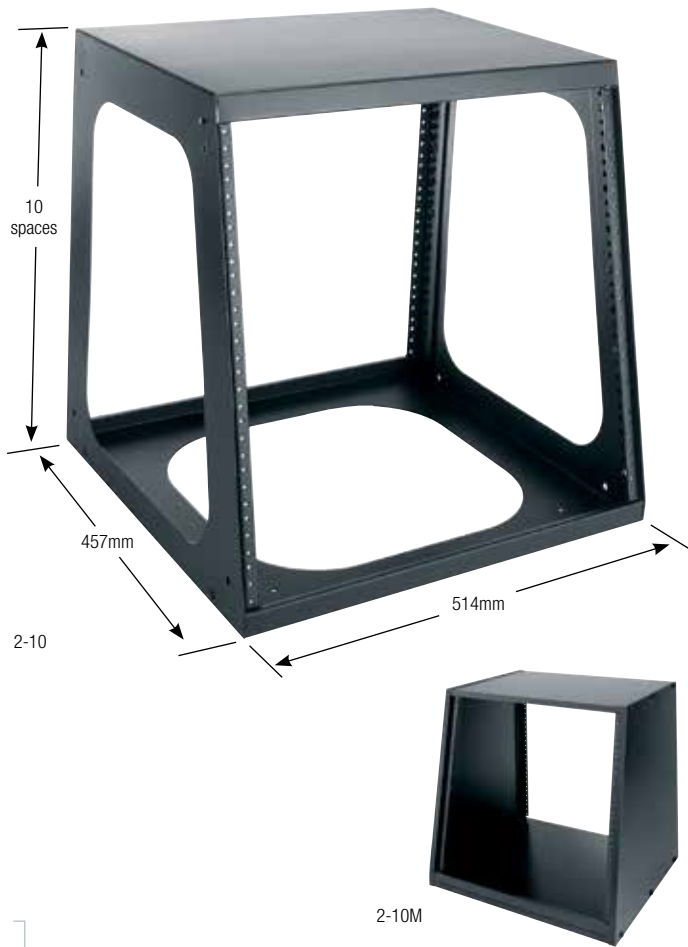

sloped desktop racks



The **Slim 2 Series** allows for quick wire passage with open sides and bottom.

- Sloping rack face for easy equipment viewing
- Models include both fully assembled and ready-to-assemble designs allowing for flat shipment via UPS
- Removable black laminate side panels
- Standard fixed front and rear 10-32 threaded rackrail
- Includes rubber feet

Certifications

- UL/ETL Listed
- RoHS
- GREENGUARD

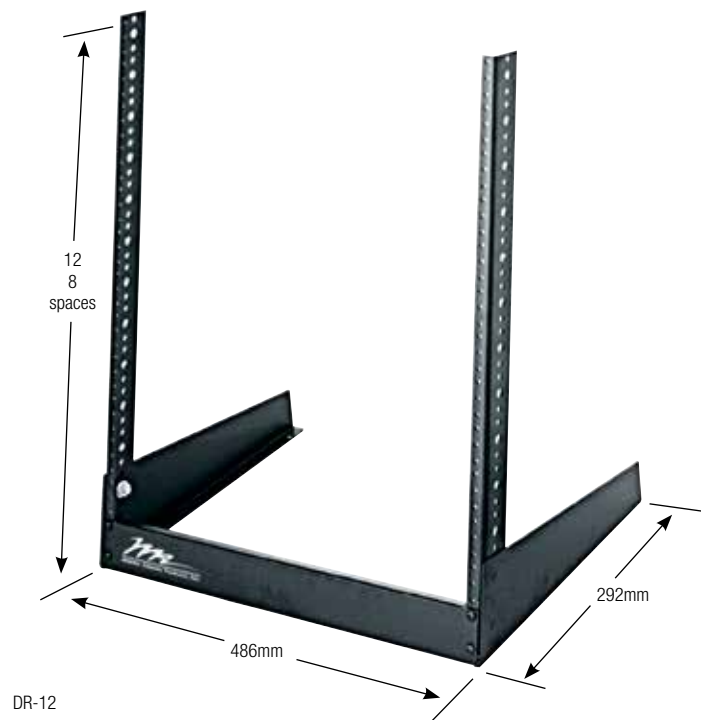

desktop rail racks



The **DR Series** rack quickly and inexpensively organizes desktop processing and test equipment.

- Gently sloped rack face for stability and to facilitate equipment viewing
- Ready-to-assemble design allows for flat shipment via UPS
- Standard fixed 10-32 threaded rackrail

Certifications

- UL/ETL Listed
- RoHS
- GREENGUARD



Product Information

Part #	Description	Racking Height	Top Depth	Bottom Depth	Overall Height
2-6M	ready-to-assemble sloped desktop rack	267mm (6 space)	403mm	454mm	324mm
2-10	fully assembled sloped desktop rack	445mm (10 space)	359mm	457mm	492mm
2-10M	ready-to-assemble sloped desktop rack	445mm (10 space)	375mm	454mm	488mm

Market Solutions



Broadcast



Commercial AV



Residential AV



Security



Structured Cabling



Education



International Fan Available

Product Information

Part #	Racking Height	Overall Height	Weight Capacity
DR-8	356mm (8 space)	408mm	34 kg
DR-12	533mm (12 space)	584mm	34 kg

Market Solutions



Broadcast



Commercial AV



Residential AV



Security



Structured Cabling



Education



International Fan Available



portable rolling racks



The **PTRK Series** rack is ideal for serving a variety of applications with smooth rolling 102mm casters, advanced cable management and secure doors.

- Fully welded steel construction for strength
- Spring-loaded recessed side handles for rack transport
- Keylocked front and rear doors standard for security
- Side panels are vented for passive thermal management
- Rear door accepts 102mm fans
- Slots in bottom of rack for cable strain relief & security equipment
- Includes heavy-duty commercial grade locking casters

Certifications

- UL/ETL Listed
- RoHS
- GREENGUARD

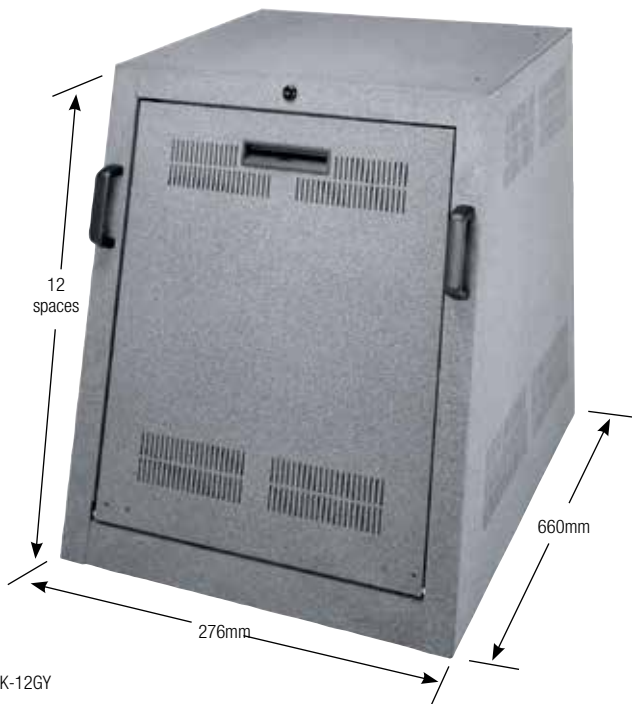

under desk rolling mobile presentation racks



The **ISRK Series** racks are ideal for all applications where an under-desk or mobile presentation rack is required, including control desk, mixing, testing and recording desks.

- Rolls under all standard height desks
- 15° slope provides an ergonomic viewing angle when used under-desk
- Scuff resistant Glide-Away™ front door stores in rack base
- Decora® knockouts accept RPS Series remote power switch
- Designed for passive thermal management

Certifications

- UL/ETL Listed
- RoHS
- GREENGUARD



Product Information

Part #	Racking Height	Overall Height Including Casters	Useable Depth
PTRK-14	622mm (14 space)	857mm	546mm
PTRK-14MDK**	622mm (14 space)	883mm	546mm
PTRK-21	933mm (21 space)	1168mm	546mm
PTRK-21MDK**	933mm (21 space)	1194mm	546mm
PTRK-1426	622mm (14 space)	857mm	622mm
PTRK-1426MDK**	622mm (14 space)	883mm	622mm
PTRK-2126	933mm (21 space)	1168mm	622mm
PTRK-2126MDK**	933mm (21 space)	1194mm	622mm
PTRK-2726	1200mm (27 space)	1435mm	622mm
PTRK-2726MDK**	1200mm (27 space)	1460mm	622mm

**Includes graphite laminate top and plexi front door

Market Solutions



Product Information

Part #	Racking Height	Overall Height
ISRK-12GY	533mm (12 rackspace)	683mm (including casters)

Options

Please visit our website for more info.

Part #	Description	Overall Height	Weight Capacity
WS1-ISRK-21G	ISRK work surface, graphite finish	adds 29mm	–
MMB-1X1C	single LCD articulating mount, black finish	–	13 kg

Market Solutions



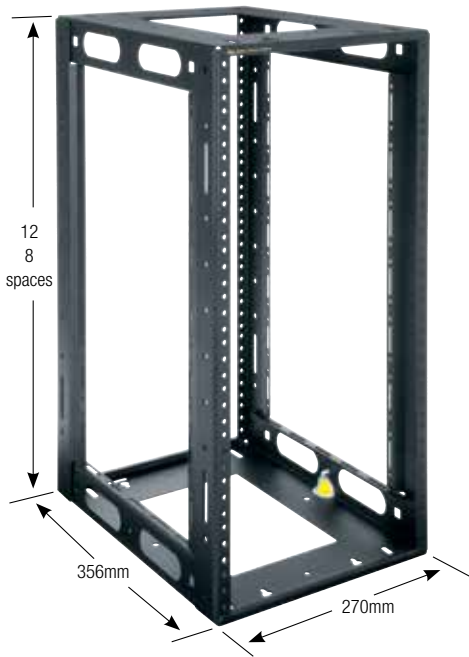

HRF-1214

half rack frame rack



The **HRF Series** is designed to accommodate half rack equipment.

- Accommodates 'half rack' equipment
- Low profile design to maximize useable space in confined areas
- Full range of accessories: shelves, panels, cooling and power products
- Strong welded steel construction
- Abundant internal cable lacing points facilitate cable management
- Standard fixed front and rear 10-32 threaded rackrail

Certifications

- UL/ETL Listed
- RoHs
- GREENGUARD



Market Solutions



Power Solutions







100VAC – 2240VAC | 50/60Hz Compatible



Product Information

Part #	Racking Height	Overall Height
HRF-814	356mm (8 rackspaces)	379mm
HRF-1214	533mm (12 rackspaces)	557mm

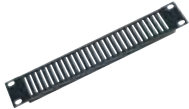
Options

					
Runner Kit	Universal Multi Shelves	Blank Panels	Vent Panels	Quiet Blower	AVIP Half Rack Fixed Panels
5-RS14	HR-UMS1-3.5 (89mm depth)	HRBL1 (1 space)	HR-EVT1 (1 space)	IHR-QBP-1	AVIP-HFK1 (1 space)
–	HR-UMS1-5.5 (140mm depth)	HRBL2 (2 space)	HR-EVT2 (2 space)	–	AVIP-HFK2 (2 space)
–	HR-UMS1-11.5 (292mm depth)	–	–	–	–

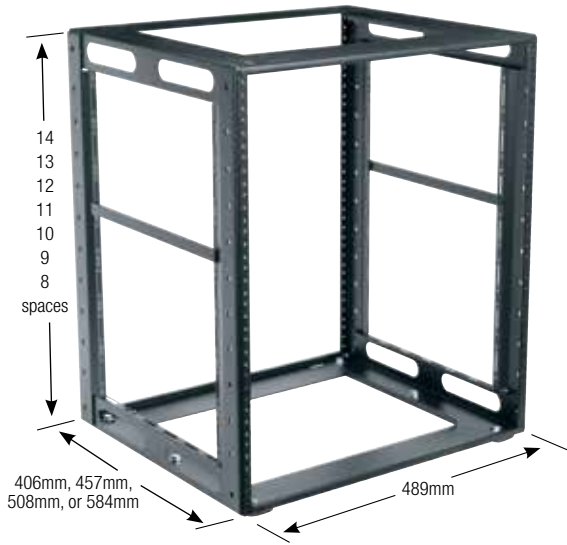

CFR-12-16

cabinet frame rack



The **CFR Series** is designed to maximize useable rackspace in entertainment systems, cabinets and similar spaces.

- Low profile design maximizes useable rackspace
- Strong welded frame allows for in-shop integration and on-site installation
- Includes feature offset cable tie ares
- Uprights feature offset cable tie areas
- Taller sizes available, please call for details

Certifications

- UL/ETL Listed
- RoHs
- GREENGUARD

Market Solutions



Broadcast



Commercial
AV



Residential
AV



Security



Structured
Cabling



Education



International
Fan Available



Product Information

406mm Useable Depth Part #	457mm Useable Depth Part #	508mm Useable Depth Part #	584mm Useable Depth Part #	Overall Height	Useable Height
CFR-8-16	CFR-8-18	CFR-8-20	CFR-8-23	379mm	356mm (8 space)
CFR-9-16	CFR-9-18	CFR-9-20	CFR-9-23	424mm	400mm (9 space)
CFR-10-16	CFR-10-18	CFR-10-20	CFR-10-23	468mm	445mm (10 space)
CFR-11-16	CFR-11-18	CFR-11-20	CFR-11-23	513mm	489mm (11 space)
CFR-12-16	CFR-12-18	CFR-12-20	CFR-12-23	557mm	21" (12 space)
CFR-13-16	CFR-13-18	CFR-13-20	CFR-13-23	602mm	578mm (13 space)
CFR-14-16	CFR-14-18	CFR-14-20	CFR-14-23	646mm	622mm (14 space)
CFR-16-16	CFR-16-18	CFR-16-20	CFR-16-23	646mm	622mm (14 space)

Options

Please visit our website for more info.

406mm Useable Depth Part #	457mm Useable Depth Part #	508mm Useable Depth Part #	584mm Useable Depth Part #	Description
5-RS16	5-RS18	5-RS20	5-RS23	low friction runner kit (adds 6mm to overall height)



overhead top hanging rack

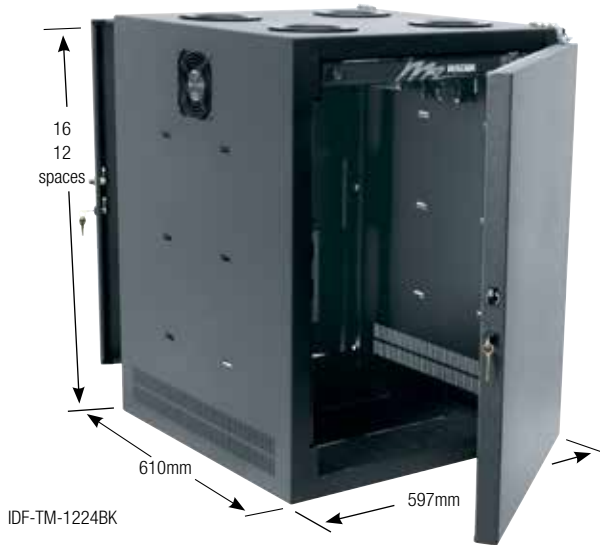

The **IDF Series** rack is ideal when rackmounting hubs, routers and other equipment overhead in warehouses, retail outlets or any larger, open location.

- Mounts directly to Unistrut® beam, to building truss or Unistrut® beam using threaded rods (not included)
- Includes a safety lanyard to ensure a secure installation
- Dual exhaust fans extend equipment life
- Aluminum bottom plate for mounting wireless antennae, dome cameras
- Multiple UHF/VHF antenna knockouts on the bottom of the enclosure
- Rack top includes four integral gland grommeted 102mm cable pass-throughs
- Standard solid front & rear locking and latched doors with safety chains
- 68 kg weight capacity

Certifications

- UL/ETL Listed
- RoHS
- GREENGUARD

desktop racks

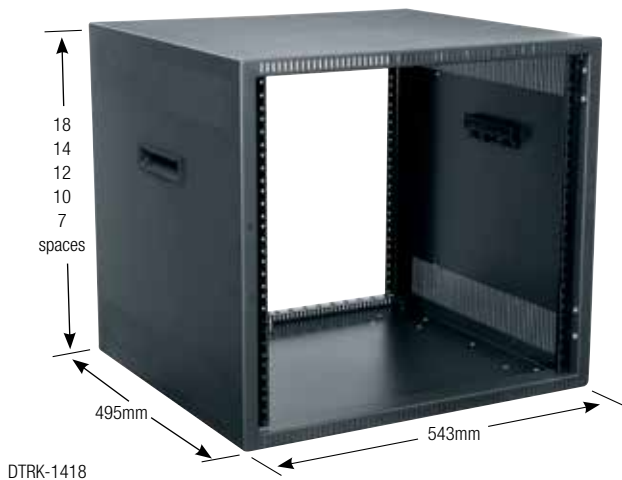

The **DTRK Series** racks provides a rackmounting solution for desktop or under-desk applications.



- Ships fully assembled, with sturdy welded steel construction
- Optional brackets provide compatibility with select Lever Lock™ accessories
- Efficient mounting Lever Lock™ system compatible (see pg. 206)
- Standard fixed front and rear 10-32 threaded rackrail

Certifications

- UL/ETL Listed
- RoHS
- GREENGUARD



Product Information

Part #	Racking Height	Useable Depth
IDF-TM-1224BK	533mm (12 space)	533mm
IDF-TM-1624BK	711mm (16 space)	533mm

Options

Please visit our website for more info.

Part #	Description
IDF-ARB-24	optional rackrail bracket extender, converts IDF to full front to rear adjustable rackrail

Market Solutions



Product Information

Part #	Racking Height	Overall Height	Useable Depth
DTRK-718	311mm (7 space)	358mm	470mm
DTRK-1018	445mm (10 space)	492mm	470mm
DTRK-1218	533mm (12 space)	581mm	470mm
DTRK-1418	622mm (14 space)	670mm	470mm
DTRK-1818	800mm (18 space)	848mm	470mm

Options

Please visit our website for more info.

Part #	Vented Front Door	Plexi/Vented Front Door	Solid Rear Access Panel w/ Brush Cable Entry	LL-DTRK Allows Vertical Lever Lock™ Height	Commercial Grade Casters
DTRK-718	DT-VFD-7	DT-PVFD-7	DT-RAP7	–	DTRK-W
DTRK-1018	DT-VFD-10	DT-PVFD-10	DT-RAP10	533mm	DTRK-W
DTRK-1218	DT-VFD-12	DT-PVFD-12	DT-RAP12	533mm	DTRK-W
DTRK-1418	DT-VFD-14	DT-PVFD-14	DT-RAP14	533mm	DTRK-W
DTRK-1818	DT-VFD-18	DT-PVFD-18	DT-RAP18	533mm	DTRK-W

Additional Options:



Lever Lock™ requires optional LL-DTRK kit

Market Solutions





2 and 4 post racks

Open frame racks, also called 2-post or 4-post racks, are widely used for cabling and patching frames, intermediate distribution points, and similar large installation purposes.

Middle Atlantic offers several styles to meet project needs, including aluminum and steel 2-post models, as well as steel 4-post and cable management racks.

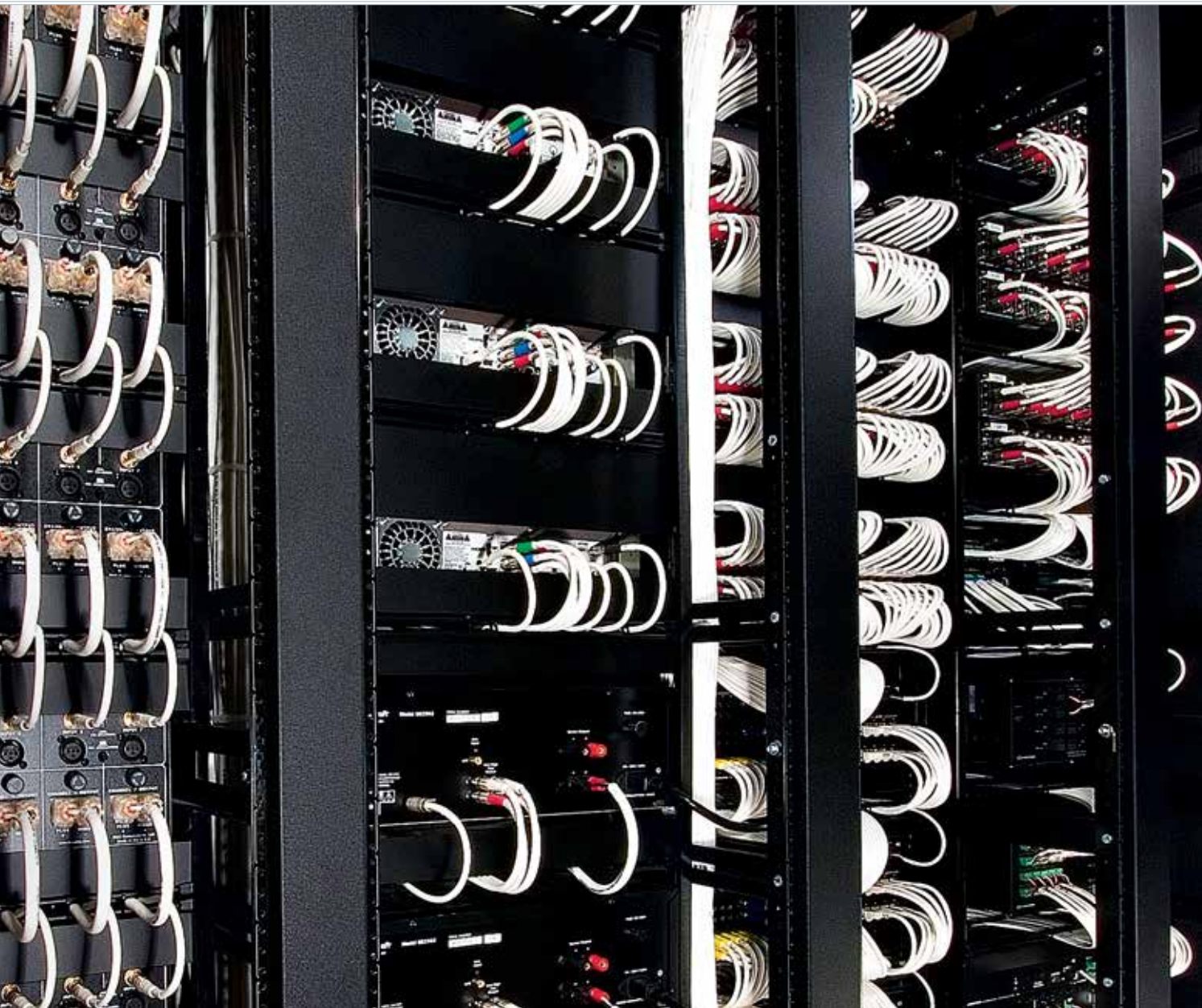
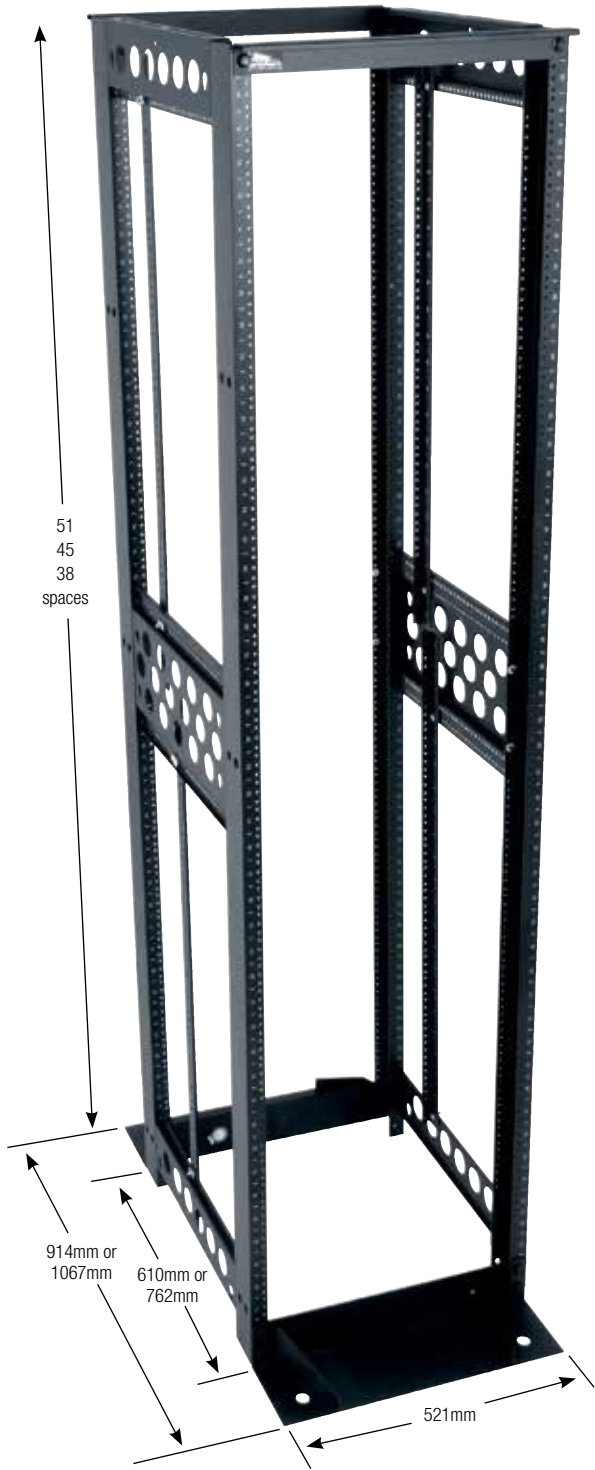

Photo courtesy of Audio One, North Miami Beach, FL

Models are available in 10-32 and 12-24 threaded styles, and some models are provided with cage nut rail. Note that the R2 series 2-post rack and the MK Series Cable Management Rack are both Seismic Certified.

Open frame racks range in capacity from 38 to 51 rackspaces.

R4 Series	114 - 115
MK Series	116 - 117
RL/RLA and R2 Series	118 - 119



R412-4524B

most advanced rack enclosure



The **R4 Series** is designed to accommodate deeper, heavier components than a two post frame rac.

- Mount networking, telephone, VOIP equipment, routers, switches and more
- Two styles are available, one with 12-24 threaded and one with cage nut
- Open top accepts direct mounting of optional cable ladder pg. 217
- Versatile base mounts inward to save space or outward for stability
- Rack gangs to additional 4-post or 2-post open frame racks
- Optional 3rd rail
- Open frame design facilitates unrestricted air flow
- Sturdy construction from heavy gauge steel or aluminum (depending on model)
- Efficient mounting Lever Lock™ system compatible (see pg. 206)
- Knockdown design allows for flat shipment
- Includes 100 pcs. of suitable fasteners
- Includes additional split rackrail to provide up to three mounting depths

Certifications

- UL/ETL Listed
- RoHS
- GREENGUARD

Market Solutions



Broadcast



Commercial
AV



Residential
AV



Security



Structured
Cabling



Education



International
Fan Available



Product Information

12-24 Threaded Rackrail Part #	Overall Width	Cage-Nut Rackrail Part #	Overall Width	Racking Height	Overall Height	Useable Depth	Overall Depth
R412-3824B	521mm	–	–	1689mm (38 space)	757mm	610mm	914mm
R412-4524B	521mm	R4CN-4524B	540mm	2000mm (45 space)	2140mm	610mm	914mm
R412-5124B	521mm	R4CN-5124B	540mm	2267mm (51 space)	96-13mm	610mm	914mm
R412-3830B	521mm	–	–	1689mm (38 space)	757mm	762mm	1067mm
R412-4530B	521mm	R4CN-4530B	540mm	2000mm (45 space)	2140mm	762mm	1067mm
R412-5130B	521mm	R4CN-5130B	540mm	2267mm (51 space)	2451mm	762mm	1067mm
–	–	R4CN-4536B	540mm	2000mm (45 space)	2140mm	914mm	1219mm
–	–	R4CN-5136B	540mm	2267mm (51 space)	2451mm	914mm	1219mm



Vertical Plastic Cable Ducts

- Make protecting, routing and organizing cables easy, see pg.215

Options

Please visit our website for more info.

12-24 Threaded Rackrail Part #	Side Panels	Add'l 12/24 Threaded Rackrail	Cage-Nut Rackrail Part #	Side Panels	Additional Cage Nut Rack Rail	Additional Cage Nut Z-Rail Adapter
R412-3824B	SPN-R4-3824	R412-RR38	R4CN-4524B	SPN-R4-4524	PROR4CN-RR45	PROR4CN-ZRA45
R412-4524B	SPN-R4-4524	R412-RR45	R4CN-5124B	SPN-R4-5124	PROR4CN-RR51	PROR4CN-ZRA51
R412-5124B	SPN-R4-5124	R412-RR51	R4CN-4530B	SPN-R4-4530	PROR4CN-RR45	PROR4CN-ZRA45
R412-3830B	SPN-R4-3830	R412-RR38	R4CN-5130B	SPN-R4-5130	PROR4CN-RR51	PROR4CN-ZRA51
R412-4530B	SPN-R4-4530	R412-RR45	R4CN-4536B	SPN-R4-4536	PROR4CN-RR45	PROR4CN-ZRA45
R412-5130B	SPN-R4-5130	R412-RR51	R4CN-5136B	SPN-R4-5136	PROR4CN-RR51	PROR4CN-ZRA51

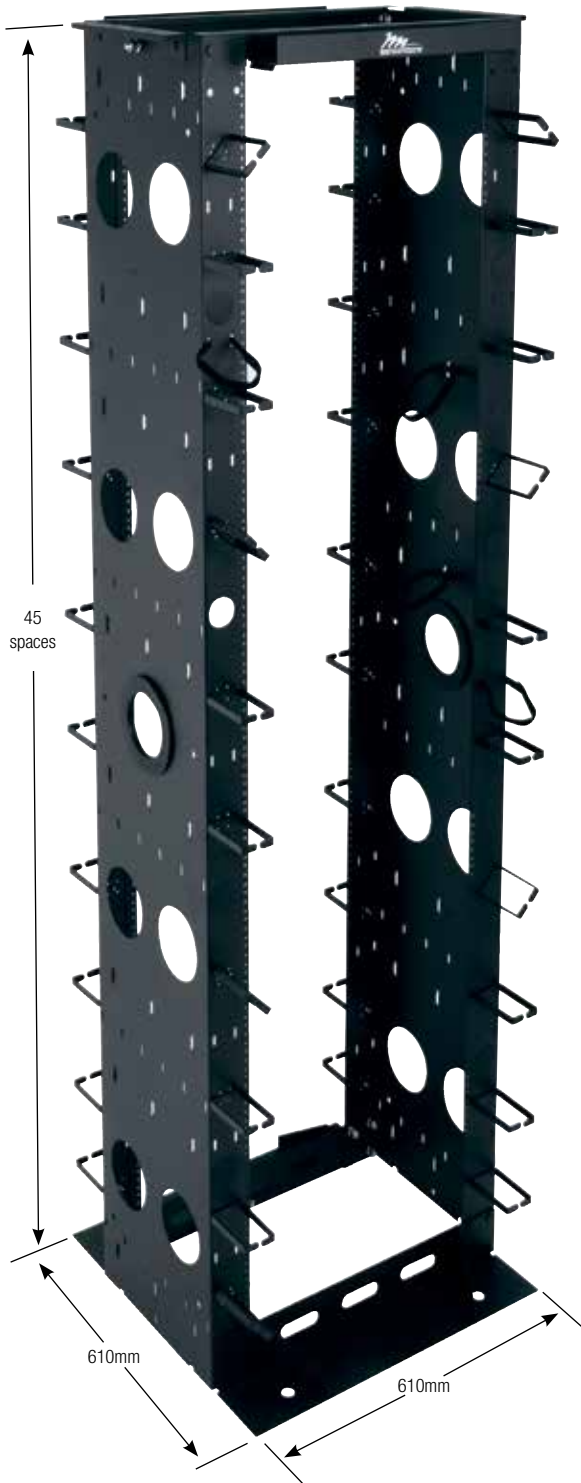

MK-1945-24

cable management rack



The **MK Series** is ideal for applications with massive cable bundles

- Sturdy steel construction
- Unique indexed swiveling front-mount cable rings
- 152mm or 356mm deep channels for massive cable bundles (depending on model)
- Integral top cable ladders and cable trays in the front and rear
- 10-32 threaded front and rear rail
- Includes hook and loop fasteners and front cable feed-through hole plugs
- Includes 100 rack screws
- Includes 2 J-bolts
- 227 or 363 kg weight capacity, depending on mounting method, see tech spec.

Certifications

- UL/ETL Listed
- RoHS
- GREENGUARD

Market Solutions



Broadcast



Commercial AV



Residential AV



Security



Structured Cabling



Education



International Fan Available



Product Information

Part #	Racking Height	Overall Height	Overall Depth	Mounting Channel Depth
MK-19-45	45 space	2140mm	418mm	162mm
MK-1945-24	45 space	2140mm	610mm	356mm



- For more horizontal cable management, see pg. 168



2 post steel open frame rack



The **RL/RLA Series** incorporates a self-squaring, self-leveling design for easy assembly.

- Top rail accommodates standard cable ladders
- Threaded 10-32 or 12-24
- RL Series channels constructed from 11-gauge steel to provide extra strength
- Knockdown design allows for flat shipment via UPS
- Self-aligning design for fast assembly
- Includes 50 rack screws

Certifications

- UL/ETL Listed
- RoHS
- GREENGUARD

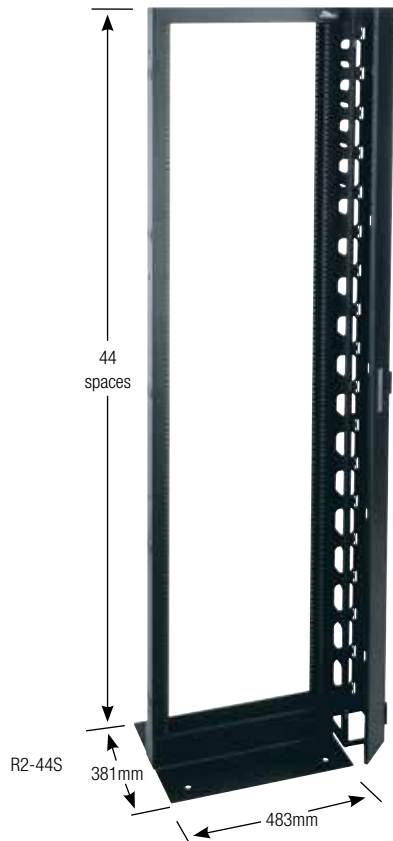

seismic certified



The **R2 Series** two post rack incorporates a heavy duty 10mm thick steel base that adds structural integrity to the steel frame.

- Top pattern holes accept a variety of cable ladders with no frame
- Fully welded all steel construction, ships assembled and ready to install
- Seismic certified for strength and reliability
- Heavy duty 10mm thick steel base
- 10-32 threaded front and rear, with numbered spaces
- Includes 50 rack screws
- 386 kg weight capacity

Certifications

- Seismic Certification
- UL/ETL Listed
- RoHS
- GREENGUARD



Product Information

Part #	Material	Racking Height	Overall Height	Rackrail Type	Finish
RL10-45	steel	2000mm (45 space)	2134mm	10-32	black
RL10-38	steel	1689mm (38 space)	1829mm	10-32	black
RL12-45	steel	2000mm (45 space)	2134mm	12-24	black
RLA19-1245B	aluminum	2000mm (45 space)	2134mm	12-24	black
RLA19-1245	aluminum	2000mm (45 space)	2134mm	12-24	silver
RLA19-1251B	aluminum	2273mm (51 space)	2442mm	12-24	black

Options

Please visit our website for more info.

Part #	Description
CSB	CSB cantilever support base adds stability
RLA, PCD and RLA-LA Series	vertical cable management options, see pg. 214

Market Solutions



Broadcast

Commercial
AVResidential
AV

Security

Structured
Cabling

Education

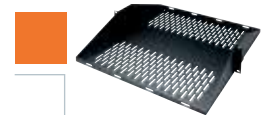
International
Fan Available

- Shelves designed for open frame racks, see pg. 196

Product Information

Part #*	Racking Height	Overall Height
R2-44S	1956mm (44 space)	8102mm

Market Solutions



Broadcast

Commercial
AVResidential
AV

Security

Structured
Cabling

Education

International
Fan Available

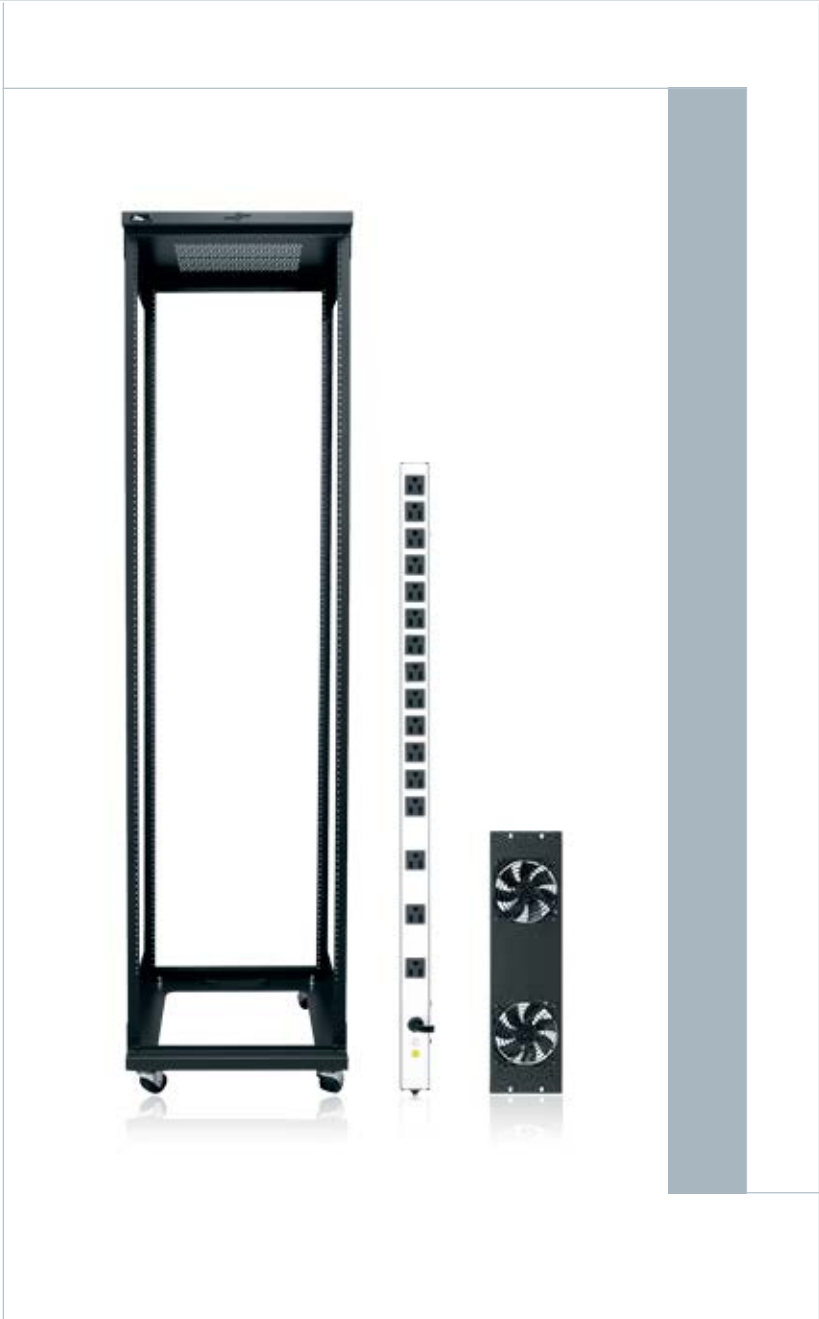

Essex by Middle Atlantic

The broadest range of everyday value solutions with trusted Middle Atlantic quality. Essex includes three distinct rack offerings, power distribution and all the accessories you need to install reliable AV systems.

Everyday value from the brand you trust.



QAR Series	122 - 123
MMR Series	124 - 125
RCS Series	126 - 127
Power Options	128
Accessory Bundles	129
Accessory Options	130 - 131

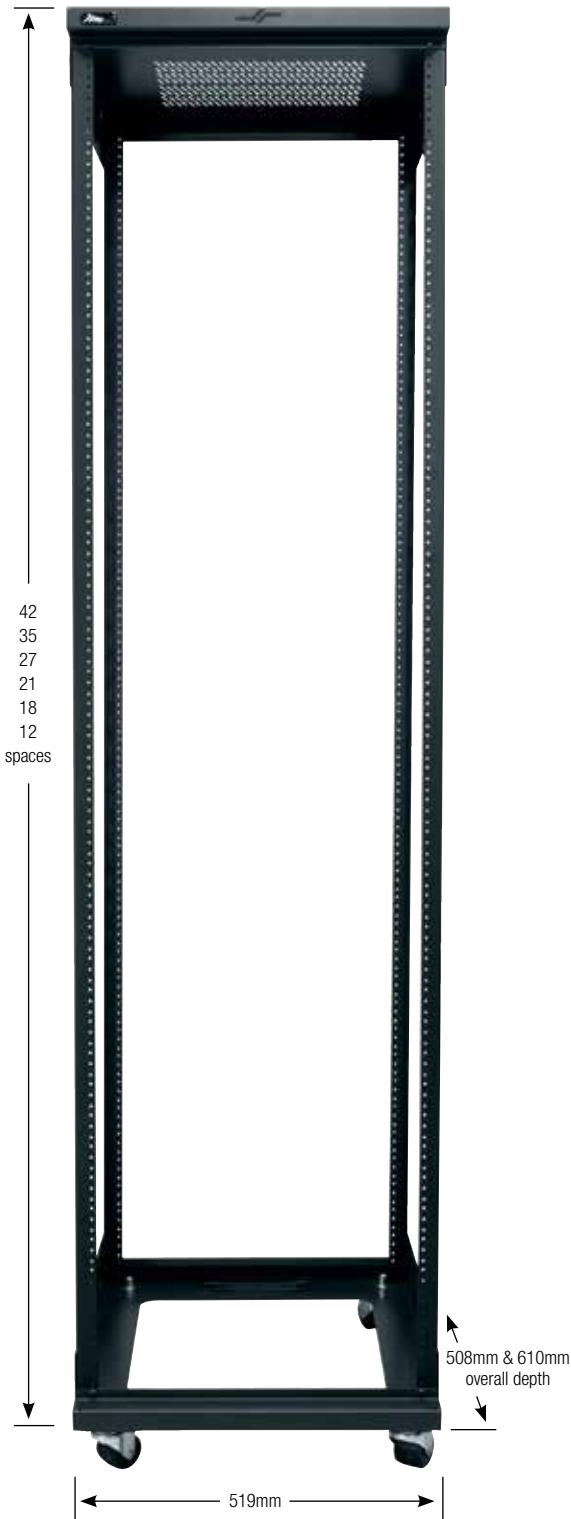

quick assembly rack



The **QAR Series** patent-pending snap together design can save 30 minutes or more in assembly time.

- Knock down skeleton frame can be outfitted with side panels, doors, power and accessory options to suit the application
- Attractive design with sleek metallic grey finish
- Ideal for installation in closets, basements, equipment rooms and other areas in the home
- Generous facilities for bottom cable entry
- Includes lockable casters; leveling feet optional for fixed installation
- Bracket included for easy mounting of power and vertical lacing strips
- Passive ventilation designed into rack top; optional quiet DC fan tops move up to 276 CFM
- UL Listed, 36kg weight capacity

Certifications

- UL Listed
- RoHS
- GREENGUARD
- UL2416



QAR-42-24

Market Solutions



Broadcast



Commercial AV



Residential AV



Security



Structured Cabling



Education



International Options



Product Information

Part #	Racking Height	Overall Height with Casters/ without Casters	Overall Depth	Useable Depth
QAR-12-20	533mm (12 space)	699mm / 630mm	508mm	438mm
QAR-12-24	533mm (12 space)	699mm / 630mm	610mm	540mm
QAR-18-20	800mm (18 space)	965mm / 897mm	508mm	438mm
QAR-18-24	800mm (18 space)	965mm / 897mm	610mm	540mm
QAR-21-20	933mm (21 space)	1100mm / 1031mm	508mm	438mm
QAR-21-24	933mm (21 space)	1100mm / 1031mm	610mm	540mm
QAR-27-20	1199mm (27 space)	1367mm / 1298mm	508mm	438mm
QAR-27-24	1199mm (27 space)	1367mm / 1298mm	610mm	540mm
QAR-35-20	1556mm (35 space)	1722mm / 1654mm	508mm	438mm
QAR-35-24	1556mm (35 space)	1722mm / 1654mm	610mm	540mm
QAR-42-20	1867mm (42 space)	2032mm / 1963mm	508mm	438mm
QAR-42-24	1867mm (42 space)	2032mm / 1963mm	610mm	540mm

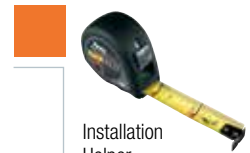
Installation
Helper

- Rackspace measuring made easy, see pg. 245

Options

Part #	Solid Front/ Rear Doors*	Plexi Front/ Rear Doors*	Side Panels (Pair)**	Vertical Power	Vertical Cable Lacing Strips (2 Pk)	Leveling Feet (Set of 4)	Accessory Bundle (pg. 129)
QAR-12-20	DOOR-S12	DOOR-P12	SIDE-12-20	PWR-8-V	LACE12-2PK	LEVELFEET-K	SMALL
QAR-12-24	DOOR-S12	DOOR-P12	SIDE-12-24	PWR-8-V	LACE12-2PK	LEVELFEET-K	
QAR-18-20	DOOR-S18	DOOR-P18	SIDE-18-20	PWR-8-V	LACE18-2PK	LEVELFEET-K	
QAR-18-24	DOOR-S18	DOOR-P18	SIDE-18-24	PWR-8-V	LACE18-2PK	LEVELFEET-K	
QAR-21-20	DOOR-S21	DOOR-P21	SIDE-21-20	PWR-8-V & PWR-16-V	LACE21-2PK	LEVELFEET-K	MEDIUM
QAR-21-24	DOOR-S21	DOOR-P21	SIDE-21-24	PWR-8-V & PWR-16-V	LACE21-2PK	LEVELFEET-K	
QAR-27-20	DOOR-S27	DOOR-P27	SIDE-27-20	PWR-8-V & PWR-16-V	LACE27-2PK	LEVELFEET-K	
QAR-27-24	DOOR-S27	DOOR-P27	SIDE-27-24	PWR-8-V & PWR-16-V	LACE27-2PK	LEVELFEET-K	
QAR-35-20	DOOR-S35	DOOR-P35	SIDE-35-20	PWR-8-V, PWR-16-V & PWR-24-V	LACE35-2PK	LEVELFEET-K	LARGE
QAR-35-24	DOOR-S35	DOOR-P35	SIDE-35-24	PWR-8-V, PWR-16-V & PWR-24-V	LACE35-2PK	LEVELFEET-K	
QAR-42-20	DOOR-S42	DOOR-P42	SIDE-42-20	PWR-8-V, PWR-16-V & PWR-24-V	LACE42-2PK	LEVELFEET-K	
QAR-42-24	DOOR-S42	DOOR-P42	SIDE-42-24	PWR-8-V, PWR-16-V & PWR-24-V	LACE42-2PK	LEVELFEET-K	

* Doors on the QAR require side panels ** Side panels add 38mm (pair) to the width

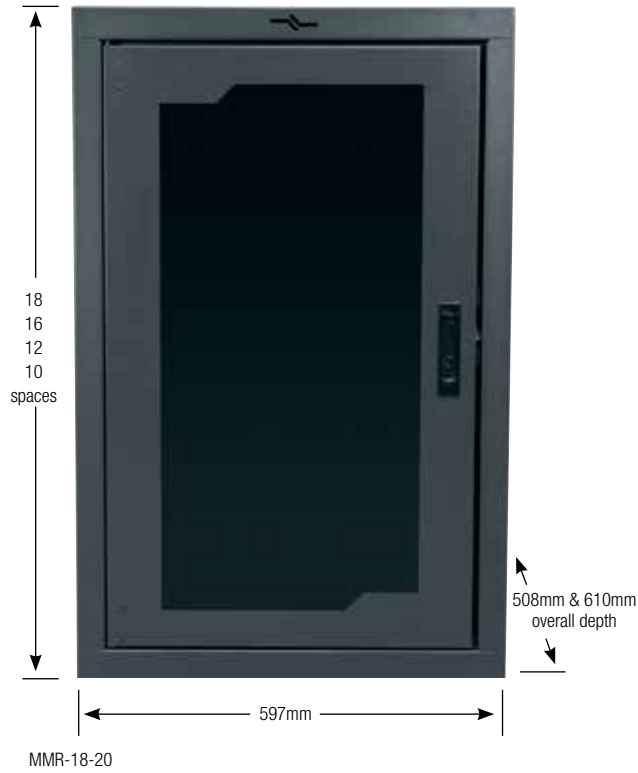

multi mount rack



The **MMR Series** is the industry's most versatile and flexible fully welded rack that can be desktop, floor-standing or wall mounted.

- Multiple wall mount options provide flexibility for budgets and workflows
- Easy access pivot, hang bracket for mounting fully integrated rack, direct-to-wall for tighter budget installations
- Ideal for installation in closets, basements, equipment rooms and other areas in the home
- Fully welded, ready-to-integrate design
- Ideal for installation in closets, basements, equipment rooms and other spaces in the home
- Attractive design with sleek metallic grey finish
- Options include casters for mobility, leveling feet for fixed installation, locking solid and plexi doors that install in seconds
- Passive ventilation designed into rack top and sides; optional quiet DC fan tops move up to 276 CFM
- UL Listed, up to 113kg weight capacity

Mounts 5 ways!



Certifications

- UL Listed
- RoHS
- GREENGUARD
- UL2416

Market Solutions



Broadcast



Commercial
AV



Residential
AV



Security



Structured
Cabling



Education



International
Options



Product Information

Part #	Racking Height	Overall Height with Casters/ without Casters	Overall Depth	Useable Depth
MMR-1020	445mm (10 space)	635mm / 569mm	508mm	457mm
MMR-1220	533mm (12 space)	724mm / 658mm	508mm	457mm
MMR-1620	711mm (16 space)	902mm / 836mm	508mm	457mm
MMR-1624	711mm (16 space)	902mm / 836mm	610mm	457mm
MMR-1820	800mm (18 space)	991mm / 925mm	508mm	559mm
MMR-1824	800mm (18 space)	991mm / 925mm	610mm	559mm

Options

Part #	Quick Hang Wall Bracket Wall Mount Option	Pivoting Back Pan Wall Mount Option	Solid Front/Rear Door	Plexi Front/Rear Door	Vertical Power	Vertical Cable Lacing Strips (2 Pk)	Accessory Bundle (pg. 129)
MMR-1020	HANG-MMR10	PIVOT-MMR-10	DOOR-S10	DOOR-P10	PWR-8-V	–	SMALL
MMR-1220	HANG-MMR12	PIVOT-MMR-12	DOOR-S12	DOOR-P12	PWR-8-V	–	
MMR-1620	HANG-MMR16	PIVOT-MMR-16	DOOR-S16	DOOR-P16	PWR-8-V	–	MEDIUM
MMR-1624	HANG-MMR16	PIVOT-MMR-16	DOOR-S16	DOOR-P16	PWR-8-V	–	
MMR-1820	HANG-MMR18	PIVOT-MMR-18	DOOR-S18	DOOR-P18	PWR-16-V	LACE18-2PK	
MMR-1824	HANG-MMR18	PIVOT-MMR-18	DOOR-S18	DOOR-P18	PWR-16-V	LACE18-2PK	



pre-configured rack system

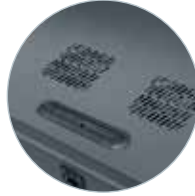

The **RCS Series** pre-configured rack system is integration-ready and is fully assembled.

- Assembled with:
 - Glass front door
 - Side and rear access panels
 - Shelves and vent panels
 - Casters and leveling feet
 - Top mounted DC fans
 - Accessory bracket for vertical power strip or lacing strips
- Fully welded, ready-to-integrate design
- Ideal for installation in closets, basements, equipment rooms and other spaces in the rooms
- Attractive design with sleek metallic grey finish
- Quiet, efficient cooling with integrated, 138 CFM DC fans
- Includes accommodations for vertical power strip and thermostatic fan controller (see pg. 227)
- UL Listed, up to 544kg weight capacity

Certifications

- UL Listed
- RoHS
- GREENGUARD



Market Solutions



Broadcast



Commercial AV



Residential AV



Security



Structured Cabling



Education



International Options

Power Solutions



100VAC – 2240VAC | 50/60Hz Compatible



Product Information

Part #	Pre-Installed Shelves	Pre-Installed 2 Space Blank Panels	Weight Capacity	Racking Height	Overall Height
IRCS-1824	(3) 2 space, 406mm deep (23kg)	3	227kg	800mm (18 space)	981mm
IRCS-2724	(4) 2 space, 406mm deep (23kg) (1) 2 space, 457mm deep (23kg)	5	340kg	1199mm (27 space)	1381mm
IRCS-3524	(5) 2 space, 406mm deep (23kg) (1) 2 space, 457mm deep (23kg) (1) 3 space, 508mm deep (45kg)	7	454kg	1556mm (35 space)	1737mm
IRCS-4224	(5) 2 space, 406mm deep (23kg) (2) 2 space, 457mm deep (23kg) (2) 3 space, 508mm deep (45kg)	9	544kg	1867mm (42 space)	2048mm

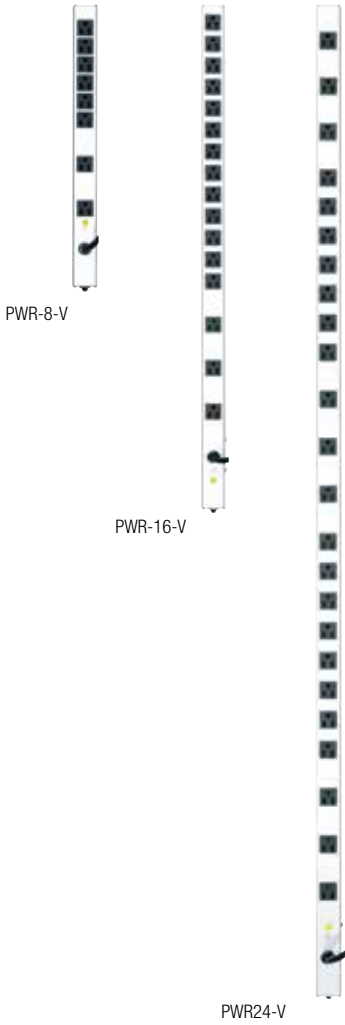

Vertical Power Distribution

- Compact profile for tight installations
- Spaced outlets for wall warts & adapters
- Three sizes (24, 16 or 8 outlets)

Power Solutions



Part #	Chassis Length	Amperage	# of Outlets	Outlet Type	Termination	Protection	Local Meter	Fits Essex Rack Sizes
PWR-8-V	457mm	15 Amp	8	5-15R	2743mm cord* w/NEMA 5-15P Plug	circuit breaker only	no	10-42 RU
PWR-16-V	838mm	15 Amp	16	5-15R	2743mm cord* w/NEMA 5-15P Plug	circuit breaker only	no	21-42 RU
PWR-24-V	1524mm	15 Amp	24	5-15R	2743mm cord* w/NEMA 5-15P Plug	circuit breaker only	no	35-42 RU



Horizontal Power Distribution

- Includes surge protection and filtering
- Models available with local meter to monitor current, voltage and power draw

Power Solutions



Part #	Amperage	Racking Height	Front Outlets	Rear Outlets	Local Meter	Cord Length	Protection	Chassis Depth	Front Power Switch
PWR-9-RP	15 Amp	44mm (1 space)	1	8	no	2743mm	L-N Surge & Filtering	95mm	Yes
PWR-9-RPM	15 Amp	44mm (1 space)	1	8	yes	2743mm	L-N Surge & Filtering	95mm	Yes



Bundled Accessory Packages

- Ordering made easy
- Bundled accessory packages enable easy ordering of frequently utilized options
- One part # includes the essential accessories which will be needed for an integrated system



SMALL

MEDIUM

LARGE

Part #	BUNDLE-SMALL	BUNDLE-MEDIUM	BUNDLE-LARGE
Fits Essex Racks	10-18 RU	21-27 RU	35-42 RU
Shelves	(2) 2 RU	(4) 2 RU	(4) 2 RU & (2) 4 RU
Blank Panels	(2) 2 RU	(4) 2 RU	(6) 2 RU
Lacer Bars	(4) straight	(4) straight & (4) 51mm Offset	(8) straight & (4) 51mm Offset
Rack Screws	50	100	200



LACE-12-2PK



LB-1A-4PK



IFANPNL-2DC



IFANTOP-138DC

Cable Management

- Vertical lacing strips – perforated with many locations for securing cable bundles
- Horizontal lacer bars – L-shape design with tie points for securing cable bundles

Vertical Lacing Strips Part #	Racking Height	Width	Tie Points	Pre-Pack Qty
LACE12-2PK	533mm (12 space)	51mm	round holes	2
LACE18-2PK	800mm (18 space)	51mm	round holes	2
LACE21-2PK	927mm (21 space)	51mm	round holes	2
LACE27-2PK	1199mm (27 space)	51mm	round holes	2
LACE35-2PK	1556mm (35 space)	51mm	round holes	2
LACE42-2PK	1867mm (42 space)	51mm	round holes	2

Horizontal Lacer Bars Part #	Style	Pre-Pack Qty
LB-1A-4PK	"L" bar	4
LB-2A-4PK	"L" bar, 51mm offset	4
LB-4A-4PK	"L" bar, 102mm offset	4

Thermal Management

- Fan top attaches to top of QAR/MMR Series racks
 - Use 2 fan tops for up to 276 CFM & easy integration slide into place & tighten
- Fan Panel - traditional rackmount panel
- Fan control unit - runs fans when temperature threshold is crossed
 - Optional for all Essex fan products, includes temperature sensor

Part #	Description	Racking Height	# of Fans	Free Air CFM	Max Sound Level	Vent Blocker
IFANPNL-2DC	fan panel	133mm (3 space)	2 DC	138 CFM	32 dBA	n/a
IFANTOP-138DC	fan top	n/a - fan top	2 DC*	138 CFM	32 dBA	included
FC-DC	thermostatic fan controller, accepts 4 DC fans					

* Two IFANTOP-138DC may be installed on QAR & MMR racks, for total of 4 fans/276 CFM/35 dBA

Power Solutions



100VAC – 2240VAC | 50/60Hz Compatible



Rack Panels

- Flanged for strength, available blank or vented
- Vent panel pattern matches design on Essex racks

Part #	Racking Height	Style	Pre-Pack Qty
VPANEL-1U-2PK	44mm (1 space)	35% open area	2
VPANEL-2U-2PK	89mm (2 space)	35% open area	2
VPANEL-3U-2PK	133mm (3 space)	35% open area	2
FBPANEL-1U-2PK	44mm (1 space)	solid	2
FBPANEL-2U-2PK	89mm (2 space)	solid	2
FBPANEL-3U-2PK	133mm (3 space)	solid	2

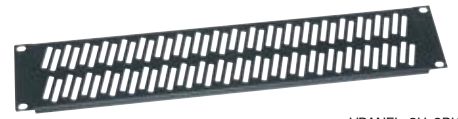

VPANEL-2U-2PK



FBPANEL-3U-2PK

Rackmount Storage and Shelves

- 2 & 4 RU drawers with integrator-installed keylock
- 2 & 4 RU vented shelves promote airflow

Part #	Racking Height	Useable Depth	Keylock	Rear Cable Entry	Pre-Pack Qty	Weight Capacity
RKDRAWER-2U-LK	89mm (2 space)	368mm	included, not installed	pass-through opening	1	16kg
RKDRAWER-4U-LK	178mm (4 space)	368mm	included, not installed	pass-through opening	1	16kg



RKDRAWER-4U-LK

Part #	Racking Height	Overall Depth	Useable Depth	Pre-Pack Qty	Weight Capacity
RKSHelf-2U-2PK	89mm (2 space)	406mm	402mm	2	23kg
RKSHelf-4U-2PK	178mm (4 space)	432mm	427mm	2	39kg



RKSHelf-2U-2PK

Accessory Bracket (Pair)

- Allows for mounting of power, LACE or other vertical options

Part #
ESX-ACC-BKT





technical furniture

Technical furniture and mounting systems from Middle Atlantic are built for user ergonomics and system reliability. Just like our racks, they incorporate the best equipment mounting technologies that are:

- Optimized for Audio-Video and Security applications
- Engineered for fast, labor-saving installation



- Innovative solutions, promoting best practices for system reliability
- Designed and manufactured with the highest quality and standards
- The industry's highest customer service levels and quick delivery

Trust your AV installs to the furniture systems built from the rack up and certified for AV – only from Middle Atlantic Products.

Frame To Furniture™	134 - 141
C5 Series Credenzas	134 - 135
L5 Series Lecterns	136 - 137
TechPed™ Series Technology Pedestals	138 - 139
HUB Collaboration Furniture	140 - 141
Consoles/Workstations	142 - 153
ViewPoint™ Series	142 - 143
Options	144 - 147
Edit Center™ Series	148 - 149
LD Series	150 - 151
MultiDesk Video™ Series	152 - 153
Carts & Stands	154 - 159
Monitoring/Display Walls	160 - 163



moderno



sofa



klasik

rack foundation with a furniture finish



Middle Atlantic Products is expanding its **C5 Series** Credenza offering to address the latest trends in commercial interior design.

- Frame to Furniture™ design complements an integrator's installation workflow
 - Frames are in stock guaranteeing quick delivery while allowing the integrator to immediately start the installation (the custom finishing kit is manufactured to order)
- Attractive styles, finishes and options reflect current design trends
- Frames are in stock guaranteeing quick delivery while allowing the integrator to immediately start the installation
- Built-in high static pressure MAP blower
- Veneer, high-pressure laminate and thermolaminate finishing options
- Available in 1, 2 or 3-bay models with standard or extra depth
- Vent finishes in white, black, silver or off-white
- Door hardware, locks and plexi door options available
- Push-touch latch included

Certifications

- UL Listed in the US and Canada
- RoHS
- GREENGUARD



To Order

Build a C5 Series credenza now. Go to our step-by-step guide online www.middleatlantic.com

Over 100,000 ways to customize
+ Millwork kits available
+ Color match veneer option

Popular Finishes

See more on pg. 249

Veneer Options – Wood Grain



Sandy – Maple Scarlett – Cherry Cerise – Sapele Ashen – Walnut Latte – Walnut Demitasse – Walnut Sepia – Walnut Mink – Cherry Titan – Walnut Noire – Sapele

HPL Options – Wood Grain



Formica White Ash Wilsonart High Line Formica Weathered Ash Wilsonart 5th Ave. Elm Wilsonart Walnut Heights Formica Pecan Woodline Wilsonart Limber Maple Formica Oiled Lengo Wilsonart Mambo Formica Blackened Lengo

Thermolaminate Options



Native Maple Fenelon Hazelnut Maple Sequoia Auburn Stream Napa Café Noir Sienna Belambra Nighttide

Door Accents



Classic Nickel Classic Bronze Modern Accent Classic Nickel Classic Bronze

Locks



Black Satin White

Vents



Black Silver Gloss White Off-White

Doors



Solid Plexi



838mm turret model, sota design in limber maple shown
584mm and 1092mm sizes also available



integration friendly lectern



The **L5 Series** lectern is the industry's most integration-friendly lectern.

- Frame to Furniture™ design complements an integrator's installation workflow
 - Frames are in stock guaranteeing quick delivery while allowing the integrator to immediately start the installation (the custom finishing kit is manufactured to order)
- 3 sizes, 2 top styles, 2 designs
- Easy to integrate: frames ship from stock to quickly get you the foundation you need to start your install
- Future proofing: damage panels can be individually replace or the entire outer shell can be refinished without removing equipment

Turret Top Style

- Customize your solution: Presenter's Panel™ is equipped with the knockouts you need and a variety of finishes & accessories are available to make each product unique
- Ideal for adding touch screens and/or controllers
- Efficient mounting Lever Lock™ system compatible (see pg. 206)

Flat Top Style

- Large work surface area for laptops
- Accommodates Wiremold® Integrate Cable Retractors – visit middleatlantic.com for more info
- Efficient mounting Lever Lock™ system compatible (see pg. 206)

Certifications

- UL Listed in the US and Canada
- RoHS
- GREENGUARD



To Order

Build a L5 Series lectern now. Go to our step-by-step guide online www.middleatlantic.com

Over 100,000 ways to customize
+ Millwork kits available
+ Color match veneer option

Popular Finishes

See more on pg. 249

Veneer Options – Wood Grain



HPL Options – Wood Grain



Thermolaminate Options

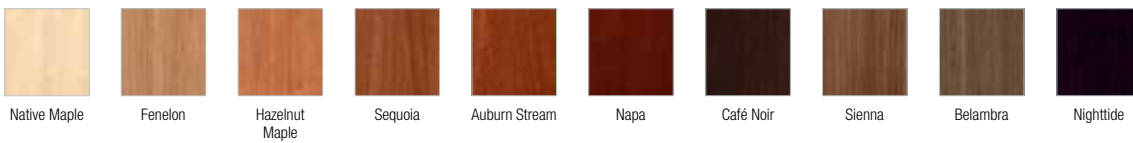

Options





easy to service solution



The **TechPed™ Series** Technology Pedestals provide under table support while housing equipment and cables; a simple to integrate, easy to service solution ideal for conference rooms and collaboration spaces.

- Frame to Furniture™ design complements an integrator's installation workflow
 - Frames are in stock guaranteeing quick delivery while allowing the integrator to immediately start the installation (the custom finishing kit is manufactured to order)
- Table support system designed to house electronics and cables
- Available in a spectrum of finishes to match any meeting room décor
- Engineered to maximize space and promote proper thermal and cable management
- The custom finishing kit is manufactured to order
- Removable side panels make installation and on-going maintenance easy
- Efficient mounting Lever Lock™ system compatible (see pg. 206)
- Includes 4 space rail



Certifications

- RoHS
- GREENGUARD



Product Information

Frame	Width	Finishing Kit*	Top & Bottom Opening	Ideal For
TP-F1318	457mm	TP-K1318	305mm x 432mm	small size tables with minimal equipment mounting
TP-F1325	635mm	TP-K1325	305mm x 610mm	small to mid size tables with equipment mounting and table top boxes
TP-F1330	762mm	TP-K1330	305mm x 737mm	mid to large size tables with equipment mounting and table top boxes with cable retractors

*Finishing kits require finish color selection.

Popular Finishes

See more on pg. 249

Veneer Options – Wood Grain



HPL Options – Wood Grain



Thermolaminate Options

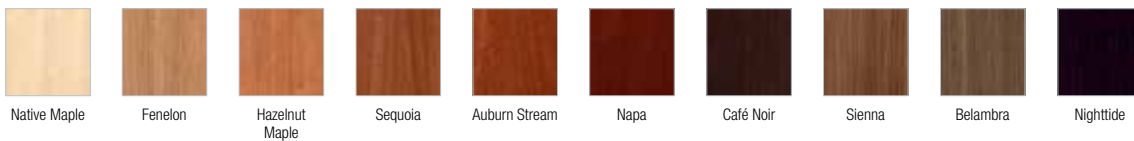

Options

Part #	Description
TCCH-M-5	under table hinged cable management, 241mm wide
UTCM	under table hinged cable management, 127mm wide
TP-MK1	custom finishing kit for millworker
TP-CR-BKT	change the mounting position of Wiremold® cable retractors*

*Required on 1318 and 1325



Tower shown is optional, display and camera mount not included.

all-in-one collaboration solution



Hub is a technology-ready, all-in-one furniture solution for collaboration spaces that is designed to maximize equipment and cable storage.

- Simple to order with a single part number for the all-in-one system and color designation, with over 50 colors available
- All-in-one furniture solution with a flexible design leveraging built-in technology to benefit both integrator and end user:
 - Integrator – Easy order, integration and servicing
 - End-user – one complete foundational huddle space unit that is built for system reliability and color options to seamlessly blend into any environment



Available in angle or bullet shape, in 6', 7' or 8' lengths and finish options in HPL and thermolaminate. Includes hardware to connect Hub to the wall.



Mounts directly to the wall or to optional tower. Flat panel displays up to 55" recommended for optimal viewing.



Two securely-mounted 4-outlet power strips: one mounts to the table bracket for connections close to the display and includes a cover; the other is located inside the TechPed™ for table box connections.



TechPed™ Technology Pedestal offers 4 RU & space for cable retractors, power distribution & small device mounting. Ships assembled for easy integration and includes keylock to secure equipment & connections.



Lever Lock™ plates included for small device mounting within the TechPed™, with room for additional Lever Lock™ accessories.



Two Wiremold® InteGreat™ HDMI® Cable Retractors extend from the table box to make connections at any seat at the table.



Wiremold® InteGreat™ Table Box provides Wiremold® and data for easy BYOD table top connections.



Built-in cable trough keeps wiring and connections neatly managed.

Certifications

- RoHS
- GREENGUARD

Power Solutions



100VAC



Product Information

	Part #	Size	Finish
Angle	HUBTS-72ANGLE-H	1829mm x 1219mm	high pressure laminate
	HUBTS-84ANGLE-H	2134mm x 1219mm	high pressure laminate
	HUBTS-96ANGLE-H	2439mm x 1219mm	high pressure laminate
	HUBTS-72ANGLE-T	1829mm x 1219mm	thermolaminate
	HUBTS-84ANGLE-T	2134mm x 1219mm	thermolaminate
	HUBTS-96ANGLE-T	2439mm x 1219mm	thermolaminate

	Part #	Size	Finish
Bullet	HUBTS-72BULLET-H	1829mm x 1219mm	high pressure laminate
	HUBTS-84BULLET-H	2134mm x 1219mm	high pressure laminate
	HUBTS-96BULLET-H	2439mm x 1219mm	high pressure laminate
	HUBTS-72BULLET-T	1829mm x 1219mm	thermolaminate
	HUBTS-84BULLET-T	2134mm x 1219mm	thermolaminate
	HUBTS-96BULLET-T	2439mm x 1219mm	thermolaminate



Popular Finishes

See more on pg. 249

HPL Options – T-Mold Edge



Limber Maple Aged Ash Fonthill Pear Glamour Cherry Versailles Anigre Mambo Studio Teak Espresso Pear Smoke Quarstone Black

Thermolaminate Options



Native Maple Fenelon Hazelnut Maple Sequoia Auburn Stream Napa Café Noir Sienna Belambra Nighttide

Options



HUBTS-TOWERS-BKT
5 ft. high tower only,
black thermolaminate finish



HUBTS-TOWERS-WHT
5 ft. high tower only,
white thermolaminate finish



HUBTS-CM-TB
camera mount,
top or bottom position



HUBTS-CASTER
caster kit,
6 included casters



HUBTS-RCP-WHITE
rear whiteboard cover,
plexiglass, gloss white finish



shown with bay extender (see pg. 145) for rackmounting deep equipment



shown with deskwall for flexible monitor mounting 457mm (457mm) console work surface provides top access to equipment and cabling



stand-alone work station shown



holds 3 convenient pre-set height settings

furniture for mission critical installations



The **ViewPoint™ Series** is specifically designed for reliability, flexibility and ergonomics.

Ideal for:

- Security and monitoring
- Command and control
- Network operating center
- Front of house controls

- Console bays are rugged, fully welded steel construction
- Engineered for fast assembly & effective equipment cooling
- Built-in cable management functions
- Certified for mission critical installations
- Built and shipped for installation that is 35% faster than the competition

Certifications

- UL/ETL Listed
- Seismic Certified
- BIFMA International
- GREENGUARD



The **ViewPoint™ Sit/Stand** workstations are specifically designed for healthy work environments with height-adjustable functionality.

- Available in console bays or as a stand-alone work station
- Factory integrated lift systems, pre-installed in welded ViewPoint™ console bays makes installation easy
- 3 programmable pre-set heights to accommodate multiple users and/or ergonomic preferences
- Lift legs do not intrude in equipment mounting bays – full bay width openings available
- Quick shipment – 3 week standard lead time for most projects

Certifications

- UL/ETL Listed
- RoHS
- GREENGUARD

Power Solutions



100VAC



To Order

Middle Atlantic Designer™ Software

Free CAD compatible 3D layout & specification software creates elevations, plan views, and quotes in minutes. Visit MiddleAtlantic.com to download.



Design Services Support

For technical questions or design assistance, please contact our Design Services support team at +1973-839-1011.

Popular Finishes

See more on pg. 249

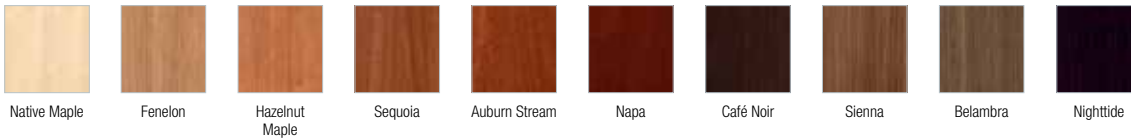

ViewPoint Sit/Stand Product Information

Part #*	Description
VC-LS3619-DT37SA	914mm w x 483mm d stand-alone ViewPoint™ lift system
VC-LS4819-DT37SA	1219mm w x 483mm d stand-alone ViewPoint™ lift system
VC-LS7219-DT37SA	1829mm w x 483mm d stand-alone ViewPoint™ lift system
VC-LSWS1-DT37SA	stand-alone ViewPoint™ lift system workstation

*When ordering, suffix part # for desired finish

Options

Please refer to the ViewPoint™ options section on pgs. 144-147 or visit our website for more info.

Part #	Description
VC-LS-SP219	pair of left and right sided panels mount on any bay



VC-LS-SP219



MMB-2X2C

Monitor Mounts

Mount to the rear of the work surface and accommodate 1, 2, 3 or 4 monitors, VESA 75 and 100 compliant.

Part #	Non-Sit/Stand Consoles Part #	Capacity Per Monitor	Weight Capacity	Configurations
MMB-1X1C	VC-MM1X1C	9kg	9kg	1x1, articulating
MMB-2X1C	VC-MM2X1C	9kg	18kg	2x1, horizontal
MMB-1X2C	VC-MM1X2C	9kg	18kg	1x2, vertical
MMB-2X2C	VC-MM2X2C	9kg	36kg	2x2, quad, two across, two levels
MMB-3X1C	VC-MM3X1C	9kg	27kg	3x1, triple horizontal



VC-MM32X41

ViewPoint™ Large Monitor Mounts

Large format monitor mounts accommodate monitors 813mm to 1600mm screen sizes and attaches directly to console at rear.

Part #	Description
VC-MM32X41	large monitor mount for 813mm to 1041mm monitors (screen size)
VC-MM42X63	large monitor mount for 1067mm to 1600mm monitors (screen size)



VC-C3624-GDFS-DC

Free Standing Storage Cabinet

The free standing storage cabinet matches appearance and style of the ViewPoint™ system to provide additional storage space.

Part #	Description
VC-C3624-GDFS-xx	free standing storage cabinet
(replace 'xx' with desired finish color)	

For additional ViewPoint™ options visit our website for more info.



ViewPoint™ CPU Tray

The CPU tray slides out of the front or rear and mounts in any 610mm console section. Extends 330mm with a weight capacity of 34kg

Part #	Usable Dimensions
VC-2419ST	483mm w x 362mm d



Chairs

Ergonomically designed and fully adjustable.

Part #	Description
CHAIR-CF1-B	contour freedom chair, gel seat/arms, black vellum
CHAIR-ADV1-B	advantage chair, wide frame black upholstered seat, mesh black
CHAIRI-TSK1-B	task basic chair, slim profile, black upholstered seat, mesh black



ViewPoint™ Rear Fan Door

Thermostatically switched and provides 100 CFM of air extraction while generating less than 27 dB.

Part #	Description
VC-B24-FD	rear fan door

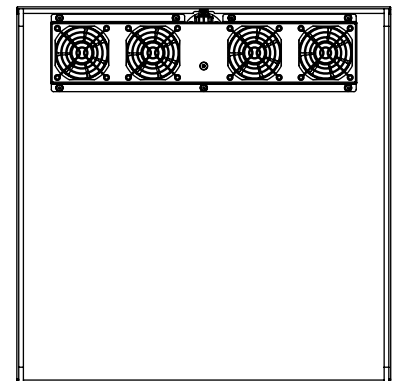

ViewPoint™ Storage Radial Binder

Keep essential reference materials close at hand with the radial binder storage cabinet, a new option in the ViewPoint™ system.

Part #	Description
VC-BC24	radial storage binder



VC-BC24

For additional ViewPoint™ options visit our website for more info.



VC-KBS

ViewPoint™ Articulating Keyboard Shelf

Articulating keyboard shelf mounts underneath work surface/desktop.

Part #	Description
VC-KBS	keyboard shelf



VC-FC-2

File Cabinet

Fits underneath peninsula. Swivel casters provide ease of movement.

Part #	Description
VC-FC-2	file cabinet



VC-B24-RR10

ViewPoint™ Rackrail

10 space front-to-rear adjustable rackrail available for horizontal equipment mounting in the front/rear of any 610mm section of a 610mm, 914mm, 1219mm, or 1829mm bay.

Part #	Description
VC-B24-RR10	10 space front-to-rear adjustable rackrail



VC-TRK

ViewPoint™ Top Rail Kit

The optional top rail kit enables vertical mounting of a UPS or similar equipment. Can be added to any full width bay and allows rackmounting of components near the workspace.

Part #	Description
VC-TRK	6 rackspace optional top rail kit

For additional ViewPoint™ options visit our website for more info.



ViewPoint™ Bay Extender

Versatile 457mm and 610mm extender cabinets integrate seamlessly with system, are ideal for mounting deep DVR's, NVR's and servers and include either a plexi or vented front door (provides 838mm & 991mm rackmount useable depths).

Part #*	Door Type	Usable Depth	Depth
VC-2418X-PD	plexiglass	457mm	838mm
VC-2418X-VD	vented	457mm	838mm
VC-2424X-PD	plexiglass	610mm	991mm
VC-2424X-VD	vented	610mm	991mm

* Please note: parts cannot be ordered individually, please call for details.



VC-2418X-VD

ViewPoint™ Desktop Turrets

Turret racks can be mounted behind 457mm work surfaces to hold equipment where it can be easily manipulated.

Part #*	Height	Mounts To
VC-TR2419-4	4 space	610mm, 1219mm, 1829mm bay
VC-TR3619-4	4 space	914mm bay
VC-TR2419-9	9 space	610mm, 1219mm, 1829mm bay
VC-TR3619-9	9 space	914mm bay

* Please note: parts cannot be ordered individually, please call for details.



VC-TR3619-4

For additional ViewPoint™ options visit our website for more info.



ELUR-GS

premium workstations



The **Edit Center™ Series** is favored by a long list of legendary musicians and artists.

- Design suits all editing environments including post production editing suites, corporate video production rooms, campus learning labs and broadcast production facilities
- Provides elegant, ergonomic workspace for video and digital content professionals
- Provides elegant, ergonomic workspace for video and digital content professionals
- Desks available in two widths, 2134mm and 1524mm
- Overbridges hold monitors for easy viewing
- Pivoting speaker platforms can be positioned for optimum listening
- Models with rackmounting areas at the work surface available
- Compatible side bays and other pieces complete your system

Certifications

- RoHS
- GREENGUARD



Product Information

Desk Only Part #	Desk + Side Bay Racks Part #	Desk Width	Includes
ES*	–	1524mm	overbridge
–	ES+S12D*	1524mm	overbridge + single bay outboard rack (with door + cooling kit)
ESUR*	–	1524mm	overbridge with (2) 4 space rackbays
–	ESUR+S12D*	1524mm	overbridge with (2) 4 space rackbays + 1 single bay outboard rack (with door + cooling kit)
EL*	–	2134mm	overbridge
–	ELUR+S12D*	2134mm	overbridge with (2) 4 space rackbays + 1 single bay outboard rack (with door + cooling kit)
ELUR*	–	2134mm	overbridge with (2) 4 space rackbays
–	ELUR+D12D*	2134mm	overbridge with (2) 4 space rackbays + 1 dual bay outboard rack (with door + cooling kit)

*When ordering, suffix part # for desired finish

Popular Finishes

See more on pg. 249

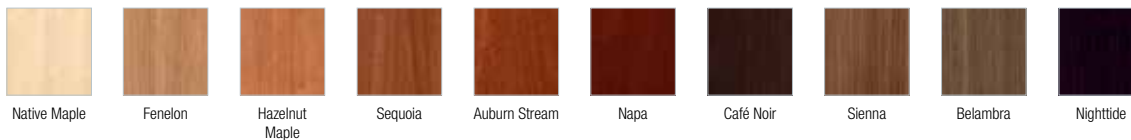

Options

Customize your solution with accessories from side bay racks and more. For monitor mount options, see pg. 144.

Part #	Description	Weight Capacity
CHAIR-CF1-B	chair, contour freedom, gel seat/arms, black vellum	–
CHAIR-ADV1-B	chair, advantage, wide frame black upholstered seat, mesh black	–
CHAIRI-TSK1-B	chair, task basic, slim profile, black upholstered seat, mesh black	–
CLAW	406mm w x 89mm d with side trays cable hanger	–
CLAW14	356mm w x 89mm d cable hanger	–
CM-L	cable management kit for 2134mm desk system, includes 8 cable managers & 6096mm cable wrap	–
CM-S	cable management kit for 1524mm desk system, includes 4 cable managers & 6096mm cable wrap	–
D12D-*	12 space dual bay outboard rack + doors/cooling system	227kg
D12SD-*	12 space dual bay outboard rack w/square top+doors/cooling system	227kg
S12D-*	12 space single bay outboard rack + doors/cooling system	136kg
S12SD-*	12 space single bay outboard rack w/square top+doors/cooling system	136kg
S24D-*	24 space sound reducing rack w/square top+doors/cooling system	136kg
S12-*	single bay outboard rack (12 rackspace), less doors	136kg
D12-*	dual bay outboard rack (12 rackspace), less doors	227kg
DT8*	table top rack (8 rackspace)	34kg

*When ordering, suffix part # for desired finish



(2) LD-4830 units shown in hazelnut maple

monitoring/command desks



The **LD Series** are modular solutions for small surveillance applications to large-scale network base command and control environments.

- Ergonomically designed with the user in mind
- Economical modular monitoring and control workstation
- Optimized for LCD monitors, with ergonomic user features
- Modular desk ships ready-to-assemble
- Add-A-Bay™ model attaches to right side of existing desk
- Small footprint (813mm deep) ideal for compact rooms



Certifications

- RoHS
- GREENGUARD



Product Information

Part #	Overall Width
LD-4830*	1219mm
LD-6430*	1626mm

*When ordering, suffix part # for desired finish

Also available in Designer

• Free design software at middleatlantic.com

• Get Quotes • Create Elevations • Plan Views



Popular Finishes

See more on pg. 249

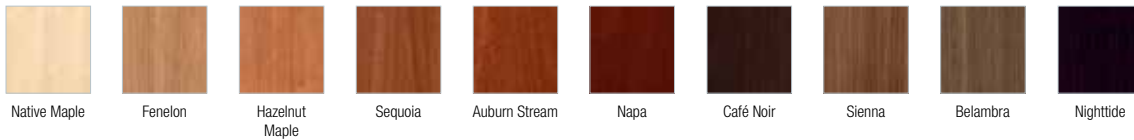

Options

Customize your solution with accessories from lighting, drawers, additional monitor supports and more. For monitor mount options, see pg. 144.

1219mm Desk Part #	1626mm Desk Part #	Description
LD-4830*RA	LD-6430*RA	Add-A-Bay™ - allows for economical expansion of desks
LD-L48	LD-L64	light bridge
LD-L4848RA	LD-L6448RA	Add-A-Bay™ light bridge
LD-SP30*		standard side panels (pair)
LD-PSP30*		full height side panels (pair)
D-CPU		articulating under-desk CPU mount
LD-QCPUT-*		isolation rack with gasketed doors, sound isolation materials, fan and work surface CPU mount
LD-LGM		adjustable light conveniently mounts in grommet of desk or wedge
LD-KB*		fully articulating keyboard shelf, includes wrist rest
CHAIR-CF1-B		chair, contour freedom, gel seat/arms, black vellum
CHAIR-ADV1-B		chair, advantage, wide frame black upholstered seat, mesh black
CHAIR-TSK1-B		chair, task basic, slim profile, black upholstered seat, mesh black
D-PT15		381mm pencil tray mounts under desk for convenient storage
D-PT22		559mm pencil tray mounts under desk for convenient storage
PD-815SC		power strip with surge protection mounts inside cable management cabinet
PD-815SC-NS		power strip without surge protection mounts inside cable management cabinet
LD-1230*		gangable side rack with smoked plexi front door and 12 rackspace of 11-gauge steel rackrail with tapped 10-32 mounting holes
LDWX*30		45° and 90° connecting wedges available with cable management
LDWTX*30		45° and 90° connecting wedges available without cable management
MMB-1X1C		monitor mount, 1x1, articulating
MMB-2X1C		monitor mount, 2x1, horizontal
MMB-1X2C		monitor mount, 1x2, vertical
MMB-2X2C		monitor mount, 2x2, quad, two across, two levels
MMB-3X1C		monitor mount, 3x1, triple horizontal

*When ordering, suffix part # for desired finish



MDV-CNR1
shown with (2) MDV-R12 & (2) MDV-OB4

economical workstations



The **MultiDesk Video™ Series** has a modular design for straight and corner applications that can be configured to meet specific needs as a corporate video editor, digital audio engineer or free-lance designer.



MDV-CNR3
shown with (2) MDV-R12 & (2) MDV-OB4

- Accessories include casters, shelving, racks and keyboard trays for a truly customized solution
- Economical studio furniture holds most popular mixers
- Modular design supports many possible configurations
- Graphite laminate top with sturdy steel tube legs



MDV-DSK
shown with (2) MDV-R12 & (2) MDV-OB4

Certifications

- RoHS
- GREENGUARD



MDV-DL
shown with (1) S12S-DC & (1) MDV-R12



Product Information

Part #	Description
MDV-CNR1	corner desk includes a one piece overbridge that is user-configurable in 3 ways
MDV-CNR3	corner desk includes a three piece overbridge to accommodate mixers with tall meter bridges; overbridge center is user-configurable in 2 ways
MDV-DSK	straight desk includes an overbridge that is user-configurable in 2 ways
MDV-DL	video desk allows MultiDesk video racks to slide underneath, saving space

Options

Customize your solution with accessories from side bay racks and more. For monitor mount options, see pg. 144.

Part #	Description
CHAIR-CF1-B	chair, contour freedom, gel seat/arms, black vellum
CHAIR-ADV1-B	chair, advantage, wide frame black upholstered seat, mesh black
CHAIR-TSK1-B	chair, task basic, slim profile, black upholstered seat, mesh black
MD-KB	keyboard tray (does not work with MDV-CNR1 or MDV-CNR3)
MDV-CK	caster kit for MDV-R12 includes 4 wheels, 2 metal caster saddles, and mounting hardware
MDV-OB4	overbridge mounts on top of the MDV-R12 rack and provides additional 4 rackspaces
MDV-R12	side bay rack for additional rackmount capacity and desktop space
MDV-W	connecting wedge to connect any MultiDesk Video Series components at a 35° angle
S12SDG	side bay rack to the MDV-DL, provides 12 rackspaces, includes front and rear rackrail, casters
MMB-1X1C	monitor mount, 1x1, articulating
MMB-2X1C	monitor mount, 2x1, horizontal
MMB-1X2C	monitor mount, 1x2, vertical
MMB-2X2C	monitor mount, 2x2, quad, two across, two levels
MMB-3X1C	monitor mount, 3x1, triple horizontal



rugged &
high capacity



The **VTC Series** Video Carts are the industry's most versatile mobile monitor cart system for videoconferencing and presentation applications.



VTC-4280S-BW

- Heavy-duty design to support large screens: up to one 2032mm or two 1778mm
- 3-space equipment mounting area in base
- Configurable mounting area of 4 rackspaces or a tower CPU
- Efficient mounting Lever Lock™ system compatible (see pg. 206)
- 249kg overall weight capacity; 113kg monitor weight capacity
- Includes low-profile 2 locking casters, adjustable camera mount
- Includes connectivity panel
- Available with 12 space rack

Certifications

- UL Listed in the US and Canada
- RoHS
- GREENGUARD



shown with (2)
1778mm displays



rack version shown
with additional 8 RU
(12 RU total)



Product Information

Black Finish Part #	Champagne Finish Part #	Display Capacity	Frame Capacity	Includes Rack
IVTC-4280S-BW	IVTC-4280S	single 1067mm - 2032mm	4 rackspaces + 254mm Lever Lock™ plate	–
IVTC-4255D-BW	IVTC-4255D	dual 1067mm - 1397mm	4 rackspaces + 254mm Lever Lock™ plate	–
IVTC-5670D-BW	IVTC-5670D	dual 1422mm - 1778mm	4 rackspaces + 254mm Lever Lock™ plate	–
IVTC-4280S-BW	IVTC-4280S-R	single 1067mm - 2032mm	12 rackspaces + 254mm Lever Lock™ plate	X
IVTC-4255D-RBW	IVTC-4255D-R	dual 1067mm - 1397mm	12 rackspaces + 254mm Lever Lock™ plate	X
IVTC-5670D-RBW	IVTC-5670D-R	dual 1422mm - 1778mm	12 rackspaces + 254mm Lever Lock™ plate	X

Finishes



black



black & champagne

Options

Black Finish Part #	Champagne Finish Part #	Description	Part #	Description
VTC-DWR-5.5-BW	VTC-DWR-5.5	140mm high X 191mm deep, drawer for VTC Series	LL-VTC-K	VTC Lever Lock™ kit, (2) LL receptacles (1) LL-HC21 (1) LL-VP2110
VTC-SPK-SH11-BW	VTC-SPK-SH5.5	140mm high, VTC speaker shelf only	VTC-WS-32X12SL	813mm wide, 305mm deep VTC work surface, slate
VTC-SPK-SH5.5-BW	VTC-SPK-SH11	279mm high, VTC speaker shelf only	VTC-R1214	12SP EIA, 356mm deep, VTC Add-On rack with glass door



FVS-800SC-WH

sleek new design



The **FlexView™ Series** is a collection of display stands and carts that are easy-to-integrate, cost-effective solutions for corporate, hospitality and education environments.

- Engineered for durability, certified for strength and safety
- Rugged casters on cart models provide long-lasting use
- Lowest profile display mount in the industry
- Models with electric lift display height adjustment for optimal ergonomics, or manual display height positioning
- Efficient mounting Lever Lock™ system compatible (see pg. 206)
- 2 RU “knobs up” rackmount ears included



FVS-800ES-BK

Certifications

- UL/ETL Listed
- RoHS
- GREENGUARD

Power Solutions



100VAC



Product Information

Part #	Base	Lift or Static	Description	Finish
FVS-800SC-BK	casters	static	FlexView single display cart with 102mm casters, up to vesa 800 mounting pattern	black
FVS-800ESC-BK	casters	electric lift	FlexView electric lift display cart with 102mm casters, up to vesa 800 mounting pattern	black
FVS-800SC-WH	casters	static	FlexView single display cart with 102mm casters, up to vesa 800 mounting pattern	white
FVS-800ESC-WH	casters	electric lift	FlexView electric lift display cart with 102mm casters, up to vesa 800 mounting pattern	white
FVS-800S-BK	levelers	static	FlexView single display stand, static with levelers, up to vesa 800 mounting pattern	black
FVS-800ES-BK	levelers	electric lift	FlexView electric lift display stand, static with levelers, up to vesa 800 mounting pattern	black
FVS-800S-WH	levelers	static	FlexView single display stand, static with levelers, up to vesa 800 mounting pattern	white
FVS-800ES-WH	levelers	electric lift	FlexView electric lift display stand, static with levelers, up to vesa 800 mounting pattern	white

Finishes



black



white

Options

Part #	Description	Finish
FVS-SBBU	FlexView soundbar attachment bracket, mounts soundbar above or below monitor, universal fit	black
FVS-CMTB-128-BK	FlexView camera mount, fits flexview cart/stand, top or bottom of screen mounting	black powdercoat
FVS-CMTB-128-WH	FlexView camera mount, fits flexview cart/stand, top or bottom of screen mounting	white powdercoat

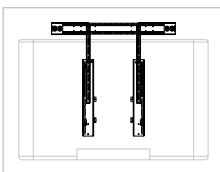

FVS-SBBU



FVS-CMTB-128-xx



integrated power



The **DisplayStation Series** carts and stands are a collection of display solutions that are ideal for simple video teleconferencing, presentation and digital signage systems.

- Every model ships with integrated power strip into the support channel
- Designed for professionally-finished installations with a convenient cable management system
- UL Listed to the highest standard for safety in multi-use environments including public, educational and institutional spaces
- Portrait to landscape adjustability of screen orientation with display mounted (single post models only)
- Competitively-priced
- Available with casters, levelers or floor plate
- Mounts single displays up to 2540mm (VESA 1000 models)
- Includes hex bits for faster assembly
- Attractive aluminum finish



integrated power strip included with every model



application engineered cable management system for a professional finish

Power Solutions



100VAC





Product Information

	Part #	Description	Finish
Carts	DS-600SC-AL	DisplayStation cart, 600 VESA, single display mount, with casters	aluminum
	DS-1000SC-AL	DisplayStation cart, 1000 VESA, 2 post single display,with casters	aluminum
Stands	DS-600SL-AL	DisplayStation stand, 600 VESA, single display mount,with levelers	aluminum
	DS-600SP-AL	DisplayStation stand, 600 VESA, single display mount with steel base plate	aluminum
	DS-1000SL-AL	DisplayStation stand, 1000 VESA, 2 post single display,with levelers	aluminum



- The DisplayStation Series also includes monitor walls, see pg. 160

Options

Part #	Description	Finish
DS-CS108-B	DisplayStation camera shelf, 245mm wide x 203mm deep	black powder coat
DS-UTS10-B	DisplayStation utility shelf, 245mm wide x 245mm deep usable area	black powder coat
DS-LSH1416-B	DisplayStation locking shelf 406mm wide x 356mm deep	black powder coat



DS-CS108-B



DS-UTS10-B



DS-LSH1416-B



integrated power



The **DisplayStation Series** carts and stands are a collection of display solutions that are ideal for simple surveillance and monitoring systems.

- Every model ships with integrated power strip that attaches to the support channel
- Designed for professionally-finished installations with a convenient cable management system and display micro-adjustment mechanism
- UL Listed to the highest standard for safety in multi-use environments, including public, educational and institutional spaces

- Competitively-priced
- Available with casters or levelers for mobile or fixed use
- Mounts displays up to 1397mm in 2x2 configuration
- Includes hex bits for faster assembly
- Attractive aluminum finish



integrated power strip included with every model



application engineered cable management system for a professional finish

Power Solutions



100VAC





Product Information

	Part #	Description	Finish
Walls	DS-600-2X2L-AL	DisplayStation stand, 600 VESA, 2x2, display wall, with levelers	aluminum
	DS-600-2X2C-AL	DisplayStation cart, 600 VESA, 2x2, display wall, with casters	aluminum



- The DisplayStation Series also includes carts and stands, see pg. 158

Options

Part #	Description	Finish
DS-CS108-B	DisplayStation camera shelf, 245mm wide x 203mm deep	black powder coat
DS-UTS10-B	DisplayStation utility shelf, 245mm wide x 245mm deep usable area	black powder coat
DS-LSH1416-B	DisplayStation locking shelf 406mm wide x 356mm deep	black powder coat



DS-CS108-B



DS-UTS10-B



DS-LSH1416-B

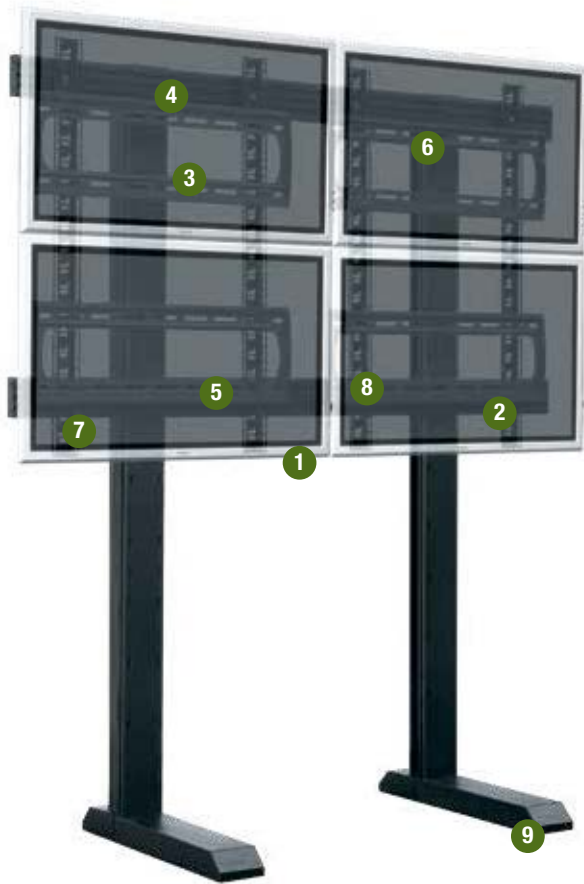

unparalleled monitor support



The **VisionFrame™ Series** monitor wall is a robust video monitor support system application engineered for unparalleled monitor support.

- Create the combination of monitor and sizes you need
- Unbeatable installation experience
- Minimal assembly required
- 3 week lead time*
- Vertical and horizontal cable management
- Versatility to mount 254mm - 2032mm screens

*Shipping time varies; contact us to confirm current time estimate

Certifications

- ETL Listed in the US and Canada
- RoHS
- GREENGUARD



1 vertical panel mount option



2 vertical multi-mount panel option

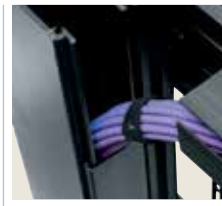

3 generous hidden vertical cable management



4 horizontal cable management



5 power strips clip easily to rear beam



6 unique cleat system eliminates measurement and guess work

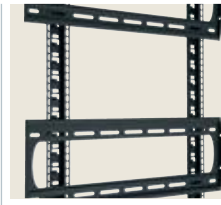

7 factory pre-assembled mount structure saves field time



8 quick turn custom Screen-Lock™ fasteners for fast assembly

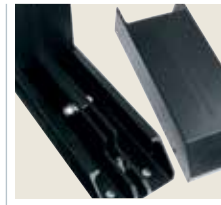

9 heavy duty support can freestanding or bolt to floor, and includes levelers



deskmount wall version attaches directly to ViewPoint™ consoles



To Order

Middle Atlantic Designer™ Software

Free CAD compatible 3D layout & specification software creates elevations, plan views, and quotes in minutes. Visit MiddleAtlantic.com to download.



Design Services Support

For technical questions or design assistance, please contact our Design Services support team at +1973-839-1011.



Surge Protection Device

- Compact surge products are ideal for installation behind flat panel displays, see pg. 174

Options

Part #	Description
VF-MPV	accessory panel mount
VF-VPM-3	three rackspace rear hanging mount



power products

Systems require reliable, accessible, safe power distribution.

Our power solutions are engineered and designed to U.S. standards to specifically meet the needs of a broad range of applications including commercial, residential, security and more.



For international customization, certification, or availability please contact export@middleatlantic.com.

Uninterruptible Power Supplies (UPS)	166 - 167
Horizontal Power Distribution	168 - 175
Vertical Power Distribution	176 - 179
Custom Power	180 - 182
Isolation Transformers	183 - 184
Power Accessories	185 - 187



Premium Series UPS Backup Power System

Premium Series UPS Backup Systems are the ideal solution for protecting high end and sensitive electronics. Featuring pure sine wave technology and IP capability.

- Pure sine wave technology provides the best power for sensitive devices
- Non-critical load shedding and high capacity batteries extend run time for critical loads
- Fast 4 millisecond transfer time ensures no system disruption or equipment lockup
- Expansion battery pack option - connect up to 10 to a single UPS for extended half-load run times up to 20 hours
- Hot swappable battery for easy service
- Both auto and scheduled shutdown/start-up/reboot to protect servers/workstations from data loss due to power failure
- 3 year warranty
- 2 rackspace

All Premium Series UPS models offer IP capability either built-in or optionally via UPS-IPCARD. Benefits of IP Capability:

- Real time UPS monitoring, remote management & configuration via web browser or NMS (Network Management System)
- Supports TCP/IP, HTTP/SNMP*, NTP, DNS and SMTP protocols
- User upgradeable firmware via FTP and security management features included

*SNMP version 1.0

Power Solutions

Our power solutions are engineered and designed to U.S. standards*



120VAC



UPS-2200R

	Part #	Description	Outlet Controlled	Dimensions	Termination	IP Card Installed
15 Amp	UPS-1000R	1000VA / 750W	Critical/Non-critical Bank	483mm W x 89mm H x 483mm D	2743mm cord w/NEMA 5-15P Plug	No
	UPS-1000R-IP	1000VA / 750W	Critical/Non-critical Bank	483mm W x 89mm H x 483mm D	2743mm cord w/NEMA 5-15P Plug	Yes
	UPS-1000R-8	1000VA / 750W	Individual Outlet	483mm W x 89mm H x 483mm D	2743mm cord w/NEMA 5-15P Plug	No
	UPS-1000R-8IP	1000VA / 750W	Individual Outlet	483mm W x 89mm H x 483mm D	2743mm cord w/NEMA 5-15P Plug	Yes
20 Amp	UPS-2200R	2150VA / 1650W	Critical/Non-critical Bank	483mm W x 89mm H x 483mm D	2743mm cord w/NEMA 5-20P Plug	No
	UPS-2200R-IP	2150VA / 1650W	Critical/Non-critical Bank	483mm W x 89mm H x 483mm D	2743mm cord w/NEMA 5-20P Plug	Yes
	UPS-2200R-8	2150VA / 1650W	Individual Outlet	483mm W x 89mm H x 483mm D	2743mm cord w/NEMA 5-20P Plug	No
	UPS-2200R-8IP	2150VA / 1650W	Individual Outlet	483mm W x 89mm H x 483mm D	2743mm cord w/NEMA 5-20P Plug	Yes
	UPS-2200R-HH	2150VA / 1650W	Critical/Non-critical Bank	483mm W x 89mm H x 483mm D	hardwired 914mm flex cable input & hardwired output	No
	UPS-EBPR	UPS Expansion Battery Pack	-	-	-	-
	UPS-IPCARD	UPS Network Interface Card	-	-	-	-
	UPS-RBP	UPS Replacement Battery Pack	-	-	-	-



Select Series UPS Backup Power System

Select Series UPS Backup Systems are a competitively priced option for ensuring uptime of electronic components in the event of a power outage. Select Series UPS models are available in compact form factors when space is at a premium, in capacities to support a wide range of installations. All models are available with web-enabled IP control.

- Value priced
- 1RU models available for one-person installation and space savings
- Remote monitoring and control of power with optional IP card
- Designed for AV and Security applications
- Simulated sine wave output waveform (on battery)
- 8 ms transfer time



UPS-S500R

All Select Series UPS models offer IP capability optionally via UPS-IPCARD. Benefits of IP Capability:

- Real time UPS monitoring, remote management & configuration via web browser or NMS (Network Management System)
- Supports TCP/IP, HTTP/SNMP*, NTP, DNS and SMTP protocols
- User upgradeable firmware via FTP and security management features included

*SNMP version 1.0

Power Solutions

Our power solutions are engineered and designed to U.S. standards*



120VAC

	Part #	Description	Outlet Controlled	Dimensions	Termination	Rackspaces
15 Amp	UPS-S500R	500VA, 120V 60HZ	bank control	432mm W x 44mm H x 222mm D	3048mm cord w/NEMA 5-15P Plug	1 space
	UPS-S1000R	1000VA, 120V 60HZ	bank control	432mm W x 44mm H x 381mm D	3048mm cord w/NEMA 5-15P Plug	1 space
	UPS-S1500R	1500VA, 120V 60HZ	bank control	432mm W x 89mm H x 381mm D	3048mm cord w/NEMA 5-15P Plug	2 space
20 Amp	UPS-S2200R	2200VA, 120V 60HZ	bank control	432mm W x 89mm H x 381mm D	3048mm cord w/NEMA 5-20P Plug	2 space
	UPS-SRBP-500	replacement battery pack 500VA	-	-	-	-
	UPS-SRBP-1000	replacement battery pack 1000VA	-	-	-	-
	UPS-SRBP-1500	replacement battery pack 1500VA	-	-	-	-
	UPS-SRBP-2200	replacement battery pack 2200VA	-	-	-	-
	UPS-IPCARD	UPS Network Interface Card	-	-	-	-



compact In-Line models great for one or two outlets

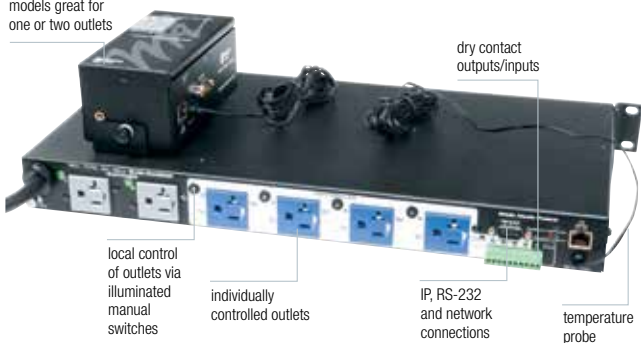

Now with patented Series Protection™!



RLNK-SW715R-NS

RackLink™ Networked Power Management System

The RackLink™ Power Management System provides integrators with system monitoring and control and is accessible locally, over the web, and through available apps for iOS and Android™ mobile devices. It is designed to help ensure system reliability and uptime through the use of intuitive setup and operation, pre-emptive problem notification and automatic problem resolution.

- Individual outlet control for up to 8 outlets
- Monitor power and temperature
- Autoping network device diagnostic/utility
- Event logging and notification
- User defined thresholds
- IP and RS-232 connectivity
- Emergency power off with automatic recovery option
- Models available with series surge protection (non-sacrificial, non-degrading)

Power Solutions

Our power solutions are engineered and designed to U.S. standards*



110VAC

Part #	Form Factor	Max Load	Rated Load	Surge Protection	Sequencing	# of Outlets		Controlled Dry Contacts	Integrated Web Server
						Total	Controlled		
RLNK-MON115-NS	In-Line Module	15A	12A	Basic	No	1	0	0	Yes
RLNK-MON120-NS	In-Line Module	20A	16A	Basic	No	1	0	0	Yes
RLNK-SW215-NS	In-Line Module	15A	12A	Basic	No	2	1	1	Yes
RLNK-SW220-NS	In-Line Module	20A	16A	Basic	No	2	1	1	Yes
RLNK-SW715R	Rackmount	15A	12A	2-Stage	No	7	5	4	Yes
RLNK-SW715R-NS	Rackmount	15A	12A	Basic	No	7	5	5	Yes
RLNK-SW620R	Rackmount	20A	16A	2-Stage	No	6	4	4	Yes
RLNK-SW620R-NS	Rackmount	20A	16A	Basic	No	6	4	5	Yes
RLNK-SW415R-SP	Half-Rack	15A	12A	Series	Yes	4	4	2	Yes
RLNK-SW815R-SP	Rackmount	15A	12A	Series	Yes	8	8	2	Yes
RLNK-SW820R-SP	Rackmount	20A	16A	Series	Yes	8	8	2	Yes



Dry Contact Controlled Power, Ideal for Simple Reboot

A simple way to control system or component power. Ideal for rebooting components or providing easy user access to power-down capability.

- Either 2 or 6 contact-closure controlled outlet banks on rear depending on model
- Settings for momentary or maintained control style, normally open or normally closed
- Built-in 2-stage surge suppression with remote notification
- No computer required; use existing control system or remote power switches



Power Solutions

Our power solutions are engineered and designed to U.S. standards*



Part #	# of Circuits	Amperage	Front Outlets	Rear Outlets		Surge Protection	Cord Length	Chassis Depth	Front Power Switch
				# of Controlled Outlets	# of Non-Controlled Duplex Outlets				
PDC-915R-2	1	15 Amp	1	2	6	Yes, 2-stage w/ remote notification	2743mm	229mm	Yes
PDC-915R-6	1	15 Amp	1	6	2	Yes, 2-stage w/ remote notification	2743mm	229mm	Yes

6-Step Sequencing

Power units that feature sequencing allow you to control the order the equipment is powered on & off. This reduces the possibility of circuit overload due to excessive in-rush current. Additionally, powering on amplifiers after source or processing equipment protects speakers from damage.

- Local or remote control with notification
- Adjustable sequencing delays up to 6 second
- Daisy chain up to three units together



Part #	# of Circuits	Amperage	Channels of Sequencing	# of Sequenced Outlets	# of Non- Sequenced Outlets	Surge Protection	Cord Length	Chassis Depth	Front Power Switch
PDS-615R	1	15 Amp	6	6 (1 per channel)	1	No	2743mm	229mm	Yes
PDS-2X315R	2	15 Amp	6	6 (1 per channel)	1	No	2743mm	229mm	Yes
PDS-620R	1	20 Amp	6	6 (1 per channel)	1 (20 Amp)	No	2743mm	229mm	Yes

Power Solutions

Our power solutions are engineered and designed to U.S. standards*





PD-915R-SP



PD-420R-SP



PD-HW15-SP

Series Protection™ Power Distribution

Middle Atlantic's Series Protection™ Power Distribution products feature the industry's fastest-responding surge protection technology.

This patented non-degrading protection won't contaminate the system ground, automatically disconnects devices to protect from sustained over and under voltage events and provides automatic recovery after these events to minimize system downtime.

- Engineered with non-sacrificial and non-degrading protection that absorbs surges without contaminating ground
- 100% MOV-free design – offering superior protection
- Automatic recovery – does not require hard reset after an over or under voltage event
- Single circuit, 15A and 20A models available
- Hardwired model available

Part #	Circuits	Rated Load	Spec Grade Output Type	Illuminated Combo Breaker ON/OFF	Outlets			Protection		
					Total	Rear	Front	Surge	Overload	Over/Under Voltage Notification LED
PD-915R-SP	1	15A	Duplex on rear, single on front	Rear (with bar)	9	8	1	Series Protection	supplementary overload protector	Two LEDs. • Over voltage • Under voltage • Default=Off
PD-920R-SP	1	20A	Duplex on rear, single on front	Rear (with bar)	9	8	1			
PD-415R-SP	1	15A	Duplex – rear only	Side (with bar)	4	4	0			
PD-420R-SP	1	20A	Duplex – rear only	Side (with bar)	4	4	0			
PD-HW15-SP	1	15A	Internal J-Box w/ cover & knockout	N/A	N/A	N/A	N/A		None	



Multi-Mount™ Rackmount Power

Offering the flexibility to place outlets where they are needed, the Multi-Mount™ series incorporates versatile mounting options into its compact design. Features mixed outlet orientation that enables various plug types to be accommodated.

- 15, 20 Amp models available
- Can also be mounted vertically
- Models available with two-stage surge protection and remote notification
- 3-step sequencing models feature 6 sequenced outlets (2 per channel) and 10 non-sequenced outlets



Sequenced

	Part #	# of Circuits	Channels of Sequencing	Front Outlets	Rear Outlets	Surge Protection	Cord Length	Front Power Switch
15 Amp	PDS-1615R	1	3	6 sequenced (2 per channel)	10	Yes, 2-stage w/remote notification	2743mm	–
	PD-1815R-RN	1	–	9	9	Yes, 2-stage w/remote notification	2743mm	–
	PD-2015R-NS	1	–	10	10	No	2743mm	–
	PD-2015R-HH-NS	1	–	10	10	No	2743mm	illuminated switch/combo breaker for front 10 outlets only
20 Amp	PDS-1620R-NS	1	3	6 sequenced (2 per channel)	10	No	2743mm	–
	PD-1820R-RN	1	–	9	9	Yes, 2-stage w/remote notification	2743mm	–
	PD-2020R-NS	1	–	10	10	No	2743mm	–



front



rear

PD-815RA-PL



front



rear

PD-915R



front



rear

PD-920RC-20



front



rear

PD-920R-NS

PD Series Rackmount Power

Middle Atlantic Products' suite of robust and flexible power products allow you to choose the power distribution product that is the perfect fit for each application.

- Line to neutral surge protection
- 15 and 20 Amp models
- 229mm chassis depth

Power Solutions

Our power solutions are engineered and designed to U.S. standards*



110VAC

	Part #	# of Circuits	Front Outlets	Rear Outlets	Surge Protection	Finish	Cord Length	LED Light Options	Front Power Switch	Outlet Orientation
15 Amp	PD-915R-PL	1	1 (15 Amp)	8	Yes	powder coat	2743mm	–	No	horizontal
	PD-815R-PL	1	–	8	Yes	powder coat	2743mm	–	No	horizontal
	PD-815RA-PL	1	–	8	Yes	brushed & anodized	2743mm	–	No	horizontal
	PD-915RV-RN	1	1 (15 Amp)	8	Yes, 2-stage w/ remote notification	powder coat	2743mm	front & rear	Yes	vertical
	PD-915R	1	1 (15 Amp)	8	Yes	powder coat	2743mm	–	Yes	horizontal
	PD-915RC-20	1	1 (15 Amp)	8	Yes	powder coat	6096mm	–	Yes	horizontal
20 Amp	PD-920R	1	1 (15 Amp)	8	Yes	powder coat	2743mm	–	Yes	horizontal
	PD-920RC-20	1	1 (15 Amp)	8	Yes	powder coat	6096mm	–	Yes	horizontal
	PD-920R-NS	1	1 (15 Amp)	8	No	powder coat	2743mm	–	Yes	horizontal



PDLT Series Rackmount Power and Lighting

These power distribution units feature a push and pop out LED light for evenly distributed illumination of the rackmounted components below.

- Adjustable brightness
- Finish options to match Middle Atlantic accessories



PDLT-815RVA

Power Solutions

Our power solutions are engineered and designed to U.S. standards*



110VAC

Part #	# of circuits	Amperage	Rear Outlets	Surge Protection	Cord Length	Chassis depth	Finish
PDLT-815RV-RN	1	15 Amp	8	Yes, 2-stage with remote notification	2743mm	343mm	black powder coat
PDLT-815RVA	1	15 Amp	8	Yes	2743mm	343mm	black brushed and anodized

PowerCool™ Series Power & Cooling Solution in One

These power distribution units provides integrated rackmount power distribution and cooling solution in convenient one rackspace package.

- Blower exhausts 50 CFM while providing high static pressure to maintain airflow
- Thermal sensing with proportional blower speed
- Multi-stage surge protection with surge status notification
- Ultra quiet operation (max sound level 29 dB) with a unique space saving design
- Multiple models for residential and commercial applications
- Key-lock switch model for additional security



PDCOOL-1115R

Power Solutions

Our power solutions are engineered and designed to U.S. standards*



110VAC

Part #	Racking Height	Description	Rated Amperage	Total #of Outlets	Free Air Rating
PDCOOL-1015RA	44mm (1 rackspace)	black brushed and anodized	15A	10	50 CFM
PDCOOL-1115R	44mm (1 rackspace)	front convenience outlet, flat black	15A	11	50 CFM
PDCOOL-1120R	44mm (1 rackspace)	front convenience outlet, flat black	20A	11	50 CFM
PDCOOL-1020RK	44mm (1 rackspace)	front key switch, flat black	20A	10	50 CFM



Compact Surge Devices

Designed to provide protection where space is at a premium, Compact Surge Protection units are ideal for installation behind flat panel displays.



PD-28-SP

Series Protection™ Compact Surge Device

Series Protection™ Compact Surge products offer the same industry leading fast response technology in the most compact stand alone device in the industry.

- Engineered with non-sacrificial and non-degrading protection that absorbs surges without contaminating ground
- Safeguards against both over and under voltage events
- Features automatic recovery – does not require hard reset after a surge event



Part #	Circuits	Rated Load	Input Type	Output Type	ComboBreaker ON/OFF	Protection			
						Surge	Overload	Over/Under Voltage Notification LED	Power On LED
PD-28-SP	1	8A	detachable cord (IEC inlet)	NEMA 5-15R	Yes	Series Protection	supplementary overload protector	Yes	Yes



2-Stage Compact Surge Device

MOV protected Compact Surge products offer the industry's most compact Line-to-Neutral stand alone surge protection device.

- Two stage technology for enhanced surge protection
- Safeguards against both over and under voltage events
- Deflects surge events to neutral without contaminating ground

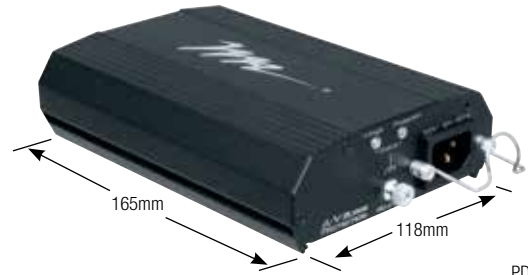

PD-215

Part #	Circuits	Rated Load	Input Type	Output Type	ComboBreaker ON/OFF	Protection			
						Surge	Overload	Over/Under Voltage Notification LED	Power On LED
PD-215	1	12A	detachable cord (IEC inlet)	NEMA 5-15R	Yes	MOV	supplementary overload protector	Yes	Yes



PDT Strips for Every Rack System

PDT Series Low Profile Power Strips take up minimal space inside a rack and feature a unique design that allows for isolated ground configurability. Dual circuit models can be configured to operate as a single circuit and all models are factory assembled for easy installation.

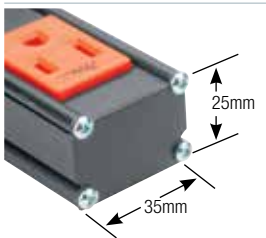

PTD 15 Amp dimensions

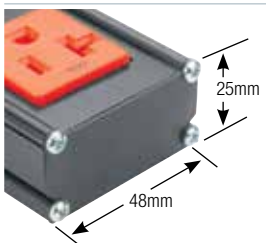

PTD 20 Amp dimensions

- Unique design allows field configurability for 1-2 circuits or isolated ground (hardwired models only)
- Slim profile from 6-20 outlets uses a minimum of space
- Easy clip mounting for faster install
- Outlets are spaced to provide enough room for plug-in power supplies

- Hardwired top feed models with J-Box on the top of the power strip, available to meet code requirements in select areas
- 15 Amp models are prewired with 12-gauge wiring and can be attached to a 20 Amp branch circuit
- Surge-protected models include LEDs for convenient local status indication, and also have dry contact closure for remote status notification
- Metered models include high-visibility red LED display; indicates current to tenths of Amps

Power Solutions

Our power solutions are engineered and designed to U.S. standards*



100VAC

corded



PDT-615C



PDT-1415C-NS

hardwired



PDT-2X615S



PDT-2X820



Product Information

		Part #	Chassis Length	Chassis Width	# of Outlets	Cord Length w/ Termination	Outlet Type	Protection	Local Meter
Corded	15 Amp	PDT-615C	762mm	35mm	6	2743mm cord w/ NEMA 5-15P plug	5-15R	single stage surge, EMI, circuit breaker	No
		PDT-615C-NS	762mm	35mm	6	2743mm cord w/ NEMA 5-15P plug	5-15R	circuit breaker only	No
		PDT-1015C-RN	959mm	35mm	10	2743mm cord w/ NEMA 5-15P plug	5-15R	2-stage surge w/ remote notification & circuit breaker	No
		PDT-1015C-NS	959mm	35mm	10	2743mm cord w/ NEMA 5-15P plug	5-15R	circuit breaker only	No
		PDT-1015C-NS20	959mm	35mm	10	6096mm cord w/ NEMA 5-15P plug	5-15R	circuit breaker only	No
		PDT-1015C-M-NS	959mm	35mm	10	2743mm cord w/ NEMA 5-15P plug	5-15R	circuit breaker only	Yes
		PDT-1415C	1524mm	35mm	14	2743mm cord w/ NEMA 5-15P plug	5-15R	single stage surge, EMI, circuit breaker	No
		PDT-1415C-NS	1524mm	35mm	14	2743mm cord w/ NEMA 5-15P plug	5-15R	circuit breaker only	No
		PDT-1615C-NS	851mm	35mm	16	2743mm cord w/ NEMA 5-15P plug	5-15R	circuit breaker only	No
		PDT-2015C-RN	1848mm	35mm	20	2743mm cord w/ NEMA 5-15P plug	5-15R	2-stage surge w/remote notification & circuit breaker	No
		PDT-2015C-NS	1848mm	35mm	20	2743mm cord w/ NEMA 5-15P plug	5-15R	circuit breaker only	No
	PDT-2015C-M-NS	1848mm	35mm	20	2743mm cord w/ NEMA 5-15P plug	5-15R	circuit breaker only	Yes	
	20 Amp	PDT-620C-NS	762mm	48mm	6	2743mm cord w/ NEMA 5-20P plug	5-20R	circuit breaker only	No
		PDT-1020C-NS	959mm	48mm	10	2743mm cord w/ NEMA 5-20P plug	5-20R	circuit breaker only	No
		PDT-1220C-NS	1524mm	48mm	12	2743mm cord w/ NEMA 5-20P plug	5-20R	circuit breaker only	No
		PDT-1620C-NS	851mm	48mm	16	2743mm cord w/ NEMA 5-20P plug	5-20R	circuit breaker only	No
		PDT-2020C-NS	1848mm	48mm	20	2743mm cord w/ NEMA 5-20P plug	5-20R	circuit breaker only	No
		PDT-2020C-RN	1848mm	48mm	20	2743mm cord w/ NEMA 5-20P plug	5-20R	2-stage surge w/remote notification & circuit breaker	No
PDT-2020C-M-NS		1848mm	48mm	20	2743mm cord w/ NEMA 5-20P plug	5-20R	circuit breaker only	Yes	
PDT-2020TL-NS		1848mm	48mm	20	2743mm cord w/ NEMA L5-20P plug	5-20R	circuit breaker only	No	
PDT-2020TL-M-NS	1848mm	48mm	20	2743mm cord w/ NEMA L5-20P plug	5-20R	circuit breaker only	Yes		

		Part #	# of Circuits	# of Outlets	Chassis Length	Chassis Width	Termination	J-Box Size L x W x H	Outlet Type	Wire Gauge	Isolated (Technical) Ground
Hardwired	15 Amp	PDT-2X615S	2	12	762mm	35mm	J-Box	102mm x 66mm x 53mm	5-15R	12	Field Configurable
		PDT-2X815	2	16	1524mm	35mm	J-Box	102mm x 66mm x 53mm	5-15R	12	Field Configurable
		PDT-2X1015	2	20	1848mm	35mm	J-Box	102mm x 66mm x 53mm	5-15R	12	Field Configurable
		PDT-2X1015S	2	20	1848mm	35mm	small J-Box	89mm x 40mm x 53mm	5-15R	12	Field Configurable
		PDT-2X1015T	2	20	1848mm	35mm	J-Box	102mm x 66mm x 53mm	5-15R	12	Field Configurable
		PDT-2X1015TS	2	20	1848mm	35mm	small J-Box	89mm x 40mm x 53mm	5-15R	12	Field Configurable
	20 Amp	PDT-2X320	2	6	762mm	48mm	J-Box	102mm x 89mm x 53mm	5-20R	12	Field Configurable
		PDT-2X520	2	10	1118mm	48mm	J-Box	102mm x 89mm x 53mm	5-20R	12	Field Configurable
		PDT-2X820	2	16	1524mm	48mm	J-Box	102mm x 89mm x 53mm	5-20R	12	Field Configurable
		PDT-2X1020	2	20	1848mm	48mm	J-Box	102mm x 89mm x 53mm	5-20R	12	Field Configurable
		PDT-2X1020S	2	20	1848mm	48mm	small J-Box	89mm x 53mm x 53mm	5-20R	12	Field Configurable
		PDT-2X1020T	2	20	1848mm	48mm	J-Box	102mm x 89mm x 53mm	5-20R	12	Field Configurable
		PDT-2X1020TS	2	20	1848mm	48mm	small J-Box	89mm x 53mm x 53mm	5-20R	12	Field Configurable



PD Slim dimensions

PD Slim Series High Density Strips

A slim profile option for simpler power requirements.

- Single circuit
- 15 and 20 Amp models available
- Supplied with U.S. style receptacle

Power Solutions

Our power solutions are engineered and designed to U.S. standards*



PD-715SC-NS



PD-2420SC-NS

	Part #	Chassis Width	# of Outlets	Chassis Length	Cord Length w/ Termination	Protection
15 Amp	PD-715SC-NS	41mm	7	330mm	3048mm cord w/ NEMA 5-15P plug	circuit breaker only
	PD-815SC	41mm	8	457mm	3048mm cord w/ NEMA 5-15P plug	surge & circuit breaker
	PD-815SC-20	41mm	8	457mm	6096mm cord w/ NEMA 5-15P plug	surge & circuit breaker
	PD-815SC-NS	41mm	8	457mm	3048mm cord w/ NEMA 5-15P plug	circuit breaker only
	PD-815SC-PBSH**	41mm	8	457mm	3048mm cord w/ NEMA 5-15P plug	surge & circuit breaker
	PD-2415SC	41mm	24	1524mm	3048mm cord w/ NEMA 5-15P plug	surge & circuit breaker
	PD-2415SC-NS	41mm	24	1524mm	3048mm cord w/ NEMA 5-20P plug	circuit breaker only
20 Amp	PD-2420SC-NS	41mm	24*	1524mm	3048mm cord w/ NEMA 5-20P plug	circuit breaker only

**Also fits on rear edge of RSH, RC, and CAP rackshelves

PD High Amp Power Distribution Strip

2 independent 15 Amp circuits fed by one 30 Amp branch circuit.

- 6 duplexes per circuit, for a total of 24 outlets
- Dual circuit breakers with lock-out pin to prevent tampering
- Outlets are color coded to indicate circuits
- Supplied with U.S. style receptacle

Power Solutions

Our power solutions are engineered and designed to U.S. standards*



PD-2X1215TL-30CB

	Part #	Chassis Width	# of Circuits	# of Outlets	Chassis Length	Cord Length w/ Termination	Protection
15 Amp	PD-2X1215TL-30CB	64mm	2	2	1435mm	2743mm cord w/ NEMA L5-30P plug	circuit breaker only



Pre-Configured MPR Series Power Distribution

Designed to save installation time, the factory-assembled MPR raceways utilize six power modules. These twelve outlet vertical strips connect to one or two 20 Amp circuits* and feed six 20 Amp duplexes (12 outlets).

- Each duplex can be independently controlled with the USC-6R Universal Sequencing Controller, or with any other sequencing controller that provides a maintained switch closure output
- 1422mm long, terminated in an integral junction box

Power Solutions

Our power solutions are engineered and designed to U.S. standards*



110VAC

prepopulated with modules



PCR-2X320A

Part #	Circuit*	Termination	Overall Length
PCR6	20 Amp (1)	J-Box	1422mm
PCR-2X320A	20 Amp (2)	J-Box	1422mm

*capable of up to 6 circuits when used with additional T Series tails.

Configure it yourself:
see pg. 178



custom power solution

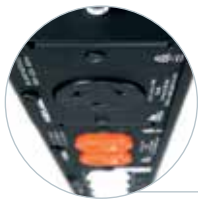

Design and build an ETL-Listed custom power solution by mixing and matching components ideal for the system's individual power requirements with the **MPR Series**. Featuring the broadest selection of circuit and control options interconnected via a proprietary pre-terminated system.

choose modular power raceways



- Lightweight raceway with versatile back-mount support clip
- Open design for easy module installation



MPR-3A

Part #	Chassis Length	Useable Module Mounting Space Using Integral J-Box	Useable Module Mounting Space Using Optional J-Box
MPR-3A	813mm	610mm	813mm
MPR-6A	1422mm	1219mm	1422mm
MPR-8A	1829mm	1626mm	1829mm
MPR-9A	2032mm	1829mm	2032mm

or stand-alone modules

- Fast, flexible solution to many installation challenges
- Ready to use with attached power cord



FC-4-1CA

Part #	Description
RLM-15-1CA	15A controlled module, 2743mm cord
RLM-20-1CA	20A controlled module, 2743mm cord
RLM30-L520-1	20A controlled module, 12 volt DC (Twistlock receptacles)
RLM30-L530-1	30A controlled module, 2743mm cord (Twistlock receptacles)
FC-4-1CA	thermostatic fan control [(4) 1-15R receptacles], 2743mm cord
FC-2-215-1CA	thermostatic fan control (2) 1-15R fan receptacles, (2) 5-15R always on fan receptacles], 2743mm cord
MPR-SEQ-1CA	6 step sequence controller, contact closure control, 2743mm cord

choose controlled modules

Now available Series Protection™



- The industry's only ETL Listed off-the-shelf configurable power strip to offer modules with Series type surge suppression
- Dry contact controlled outlets



RLM-20A-SP

or always on modules

Now available Series Protection™

- Multiple outlet configurations available with ground options
- Models with Series Protection™ now available



M-15A-SP

Part #	Module Size	Description
RLM-15A	203mm	15A controlled module
RLM-15A-SP	203mm	15A controlled module w/ Series Protection™
RLM-20A	203mm	20A controlled module
RLM-20A-SP	203mm	20A controlled module w/ Series Protection™
RLM-20IGA	203mm	20A isolated ground controlled module
RLM-30TL-HWIGA	203mm	30A controlled module, contact closure control
FC-4A	203mm	thermostatic fan control module [(4) 1-15R fan receptacles]
MPR-SEQA	203mm	6 step sequencing controller, contact closure control

Part #	Module Size	Description	Part #	Module Size	Description
M-15A	102mm	15A duplex module	M-2X20A	203mm	20A double duplex module
M-15A-SP	102mm	15A duplex module w/ Series Protection™	M-2X20IGA	203mm	20A double duplex isolated ground module
M-20A	102mm	20A duplex module	M-15IECA	102mm	15A 3-gang IEC module
M-20A-SP	102mm	20A duplex module w/ Series Protection™	M-20IECA	102mm	20A 1-gang IEC module
M-20IGA	102mm	20A duplex isolated ground module	M-20TL-HWA	102mm	20A twist lock L5-20R (hardwired only)
M-2X15A	203mm	15A double duplex module	M-30TL-HWA	102mm	30A twist lock L5-20R (hardwired only)



choose blank covers

STEP 3

- Blank cover for MPR raceway position



MPR-BL8A

Part #	Module Size	Description
MPR-BL2A	51mm	sold in packs of two
MPR-BL4A	102mm	sold individually
MPR-BL8A	203mm	sold individually

or junction boxes

- Optional J-box fits on end of MPR raceway
- Equipped w/electrical knockouts



MPR-JB663A

Part #	Description
MPR-JB663A	optional 152mm x 152mm x 76mm J-Box
MPR-JB843A	optional 203mm x 102mm x 76mm J-Box
MPR-JB853A	optional 203mm x 127mm x 76mm J-Box
MPR-JB863A	optional 203mm x 152mm x 76mm J-Box

or module accessories

- Ground wires with ring terminals (one end) simplifies attachment of multiple ground wires to a supplemental grounding stud
- MPR-SS transient voltage surge suppressor provides protection for MPR Series modules when mounted in raceways

Part #	Description
G-8X10	ten 203mm ground wires
MPR-SS	MPR surge suppressor, single circuit



MPR-SS

choose module connections

STEP 4

- Jumpers (J) interconnect power modules, providing AC power to all modules on the same circuit
- Tails (T) connect incoming power to a single circuit within a raceway
- Master/slave jumpers (JMS) control M Series basic modules by advancing the RLM Series on the same circuit
- 6 packs



T-80X6

Part #	Jumper Length	Termination
J-12X6	305mm	connector on each end
J-24X6	610mm	connector on each end
J-72X6	1829mm	connector on each end
T-24X6	610mm	connector on one end, tails on the other
T-80X6	2032mm	connector on one end, tails on the other
JMS-12X6	305mm	connector on one end, connector plus push-on terminal on the other

Want Middle Atlantic to build it for you?
Call us at 800-266-7225

Power Solutions

Our power solutions are engineered and designed to U.S. standards*



110VAC



Example showing 6 circuits and other choices with junction box on top



power connections on top or bottom to match install design

30 Amp circuits and IEC outlets available

multiple receptacles can be grouped on one circuit

outlets available in various colors for identification or other purposes

permanent laser etched designations

custom laser etched markings can be specified such as a logo, message, or contact information

PDW Series Multi-Circuit, High Capacity Power Distribution

Custom power made to your specifications and shipped within 4 days.

- Large standard capacity: up to twenty 15A or 20A circuits, or up to eight 30A circuits
- Custom lengths up to 2134mm
- Mix circuit types on one strip
- Choose outlet color and orientation, ground type (including individual or common conductors), and termination
- Custom tail lengths
- Specify your circuit numbers for permanent laser markings
- 15 Amp, 20 Amp, 30 Amp and IEC receptacles available

Power Solutions

Our power solutions are engineered and designed to U.S. standards*



110VAC

Available termination choices include:



1. Flexible custom length greenfield conduit



2. Junction Box

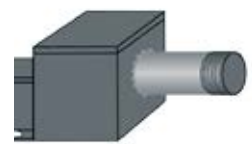

3. Or pipe nipple termination

Additional sized boxes and adapters available

Visit our website to configure or call customer service

Part #	Circuit	Termination	# of Outlets	OD Length
PDW-12X220J	20 Amp (20)	J-Box	24	1562mm
Preconfigured models available				



IsoCenter™ Rackmount Isolation Transformer & Load Center System

High efficiency toroidal transformer – greater than 98%

- Integrated load center with four 20A circuits, all on the same phase
- Optional 100,000 Amp 2-stage surge and spike protection
- Patented “soft start” technology to allow safe turn on without tripping breakers
- Eighteen receptacles for load distribution
- Input voltage monitoring with auto shutdown functions
- 208V or 240V (depending on model) input voltage, single phase



ISOCTR-5R-240-NS and ISOCTR-5R-208-NS

Part #	Capacity	Input Voltage	Surge Protected	Sequencing	Remote Branch Circuit Extension	Safety Ground Monitoring	Ground Sense Technology	Load Current Metering	Racking Height	Depth	Rear Mounting Range	Termination	Finish
ISOCTR-5R-240-2	5kVA	240V	100,000 Amps	-	Yes	-	-	-	178mm (4 space)	365mm	441mm - 619mm	NEMA L6-30P	black powder coat
ISOCTR-5R-208-2	5kVA	208V	100,000 Amps	-	Yes	-	-	-	178mm (4 space)	365mm	441mm - 619mm	NEMA L6-30P	black powder coat
ISOCTR-5R-240-NS	5kVA	240V	-	-	-	-	-	-	178mm (4 space)	365mm	441mm - 619mm	NEMA L6-30P	black powder coat
ISOCTR-5R-208-NS	5kVA	208V	-	-	-	-	-	-	178mm (4 space)	365mm	441mm - 619mm	NEMA L6-30P	black powder coat

PowerCore™ Models

Integrated & adjustable branch circuit sequencing.

- Integrated & adjustable branch circuit sequencing
- Safety ground current monitoring with automatic shutdown for system and life safety protection
- Patented “soft start” technology to allow safe turn on without tripping breakers
- Remote dry-contact control of power functions, cycling, and resets
- Enhanced aesthetics for high profile installations



EP-CORE-5R-240

Part #	Capacity	Input Voltage	Surge Protected	Sequencing	Remote Branch Circuit Extension	Safety Ground Monitoring	Ground Sense Technology	Load Current Metering	Racking Height	Depth	Rear Mounting Range	Termination	Finish
EP-CORE-5R-240	5kVA	240V	100,000 Amps	Yes	Yes	Yes	Yes	Yes	267mm (6 space)	425mm	445mm - 654mm	NEMA L6-30P	designer inspired milled black brushed and anodized
EP-CORE-5R-208	5kVA	208V	100,000 Amps	Yes	Yes	Yes	Yes	Yes	267mm (6 space)	425mm	445mm - 654mm	NEMA L6-30P	designer inspired milled black brushed and anodized



EP-CORE-25-240

PowerCore™ Isolation Transformers

Eliminate the need for expensive rackmount surge and spike protection and power conditioners with the solution that also helps eliminate most common causes of hum and buzz, helps remove ground loop problems and prevents most control system reboots and lockups.

- 10, 15, 25 kVA capacity available
- Includes surge protection & filtering
- Free standing unit

Part #	Description	Inputs
EP-CORE-25-240	25kVA, PowerCore with Surge Protection and Filtering	240
EP-CORE-25-208		208
EP-CORE-15-240	15kVA, PowerCore with Surge Protection and Filtering	240
EP-CORE-15-208		208
EP-CORE-10-240	10kVA, PowerCore with Surge Protection and Filtering	240
EP-CORE-10-208		208



CORE-25-240-U2

PowerCore™ Isolation Transformer with Integrated UPS

Centrally located hardwired UPS units back up branch circuits to replace local UPS units.

- Centrally located hardwired UPS units back up branch circuits to replace local UPS units
- Remote IP outlet monitoring and control allows web-based troubleshooting and rebooting of specific devices
- System-wide surge and spike protection is built in
- All branch circuits are same-phase
- System is expandable and can be tailored to have the needed backed-up circuits & runtimes

Call for modification and custom requests

Part #	Capacity	2200VA UPS Qty/ Backed Branch Circuits	Dimensions H x W x D
CORE-10-240-U1	10kVA	1	1499mm x 559mm x 660mm
CORE-10-240-U2	10kVA	2	1499mm x 559mm x 660mm
CORE-15-240-U1	15kVA	1	1880mm x 559mm x 660mm
CORE-15-240-U2	15kVA	2	1880mm x 559mm x 660mm
CORE-15-240-U3	15kVA	3	1880mm x 559mm x 660mm
CORE-25-240-U1	25kVA	1	1880mm x 559mm x 660mm
CORE-25-240-U2	25kVA	2	1880mm x 559mm x 660mm
CORE-25-240-U3	25kVA	3	1880mm x 559mm x 660mm
CORE-25-240-U4	25kVA	4	1880mm x 559mm x 660mm



IEC Power Cords

Simplify the system's power cord management by replacing excess bundles with IEC power cords. Purpose-length power cords free up space to give the rack better organization and less-impeded airflow.

SignalSAFE™ IEC Power Cords

- Featuring tightly twisted conductors to reduce the effects of AC magnetic fields, allowing closer integration of power and signal cables
- Sold in packs of 4, 20 and 100
- Straight and angled plugs



152mm to 1219mm

Power Solutions

Our power solutions are engineered and designed to U.S. standards*



100VAC

152mm Length Part # **	305mm Length Part # **	457mm Length Part # **	610mm Length Part # **	914mm Length Part # **	48" Length Part # **	Plug Type	Cord Stripe color	Wire Gauge	Qty.
IEC-6X4	IEC-12X4	IEC-18X4	IEC-24X4	IEC-36X4	-	Straight	Blue	14	4
IEC-6X20	IEC-12X20	IEC-18X20	IEC-24X20	IEC-36X20	IEC-48X20	Straight	Blue	14	20
IEC-6X20-RED	IEC-12X20-RED	IEC-18X20-RED	IEC-24X20-RED	IEC-36X20-RED	IEC-48X20-RED	Straight	Red	14	20
IEC-6X100	IEC-12X100	IEC-18X100	IEC-24X100	IEC-36X100	IEC-48X100	Straight	Blue	14	100
IEC-6X20-90L	IEC-12X20-90L	IEC-18X20-90L	IEC-24X20-90L	IEC-36X20-90L	IEC-48X20-90L	Low-Profile Left Hand	Blue	14	20
IEC-6X20-90R	IEC-12X20-90R	IEC-18X20-90R	IEC-24X20-90R	IEC-36X20-90R	IEC-48X20-90R	Low-Profile Right Hand	Blue	14	20
IEC-6X20SC*	IEC-12X20SC*	IEC-18X20SC*	IEC-24X20SC*	IEC-36X20SC*	IEC-48X20SC*	Straight	Blue	18	20

* Denotes cable/satellite cord. ** Length refers to the cord only, and does not include the connectors.

Economy IEC Power Cords

- Competitive price, with trusted Middle Atlantic quality
- Designed and packaged for Integrator convenience
- The widest selection of IEC cord lengths in the AV industry
- Industry-standard 18 AWG conductors with 10A max current rating



152mm to 1829mm

Power Solutions

Our power solutions are engineered and designed to U.S. standards*



100VAC

152mm Length Part #	305mm Length Part #	457mm Length Part #	610mm Length Part #	1829mm Length Part #	Plug Type	Connector Type	Wire Gauge	Qty.
-	S-IEC-12X6	S-IEC-18X6	S-IEC-24X6	-	Straight	IEC 60320-1/C13	18	6
-	S-IEC-12X20	S-IEC-18X20	S-IEC-24X20	-	Straight	IEC 60320-1/C13	18	20
S-IEC-6X100	S-IEC-12X100	S-IEC-18X100	S-IEC-24X100	S-IEC-72X100	Straight	IEC 60320-1/C13	18	100



USC-6R

Sequencing Controller for Contact Closure - Triggered Devices

Rackmount USC-6R provides six-step sequencing to any AC power distribution system that can be controlled by low voltage switch closure.

- Sequencing may be initiated locally via convenient front panel switch or remotely by any momentary contact closure switch (single pole, double throw, center off)
- Interval delay selector of 1, 3 or 6 seconds between steps and four different start delay settings to allow up to three USC-6R units to be interconnected to operate as a single, 18-step unit

Power Solutions

Our power solutions are engineered and designed to U.S. standards*



110VAC

Part #	Description	Steps	Control Options	Interval Delay
USC-6R	rackmount sequencing controller	6 individually sequenced	contact closure	1, 3, or 6 seconds



RPS

RPS Series, Remote Power Control

The Remote Power Switch allows complete 15 Amps systems to be powered on and off without the need to access equipment. Mounts in the face of select racks, single space panel or UCP Series Universal Connector Panel.

- Switch and keylock models available
- Fits in any Decora® device opening

Power Solutions

Our power solutions are engineered and designed to U.S. standards*



100VAC

Part #	Description
RPS	15 Amp remote power switch
RPS-K	15 Amp remote power switch, keylocked
RPS-KEY	additional set of 2 keys

UL File #: E232496 UL Standard #: 244A: Appliance Controls 120 VAC, 15 Amps, 60 Hz

For additional grounding & bonding accessories, see the following products:

Isolation Leveling Feet	pg. 47
Spike, Rack Bonding Kits	pg. 242
Rack Ground Isolation Kits	pg. 244
Electrical Isolation Knockout Panel	pg. 244



Copper Bus Bars

Copper bus bars are 3mm thick and threaded 10-32.

- Various heights and widths available
- Supplied mounting hardware includes nylon isolation washers, bolts & nuts



BB-12

Part #	Racking Height	Width	Qty
BB-5254-1	2007mm	25mm	1 bar
BB-44-1	1956mm (44 space)	25mm	1 bar
BB-40	1778mm (40 space)	51mm	1 bar
BB-12	533mm (12 space)	51mm	1 bar

Power Solutions

Our power solutions are engineered and designed to U.S. standards*



Remote Switches

Remote switch options include a switch or key to initiate up/down sequencing remotely.

- Wall plate and Decora® mount switches available
- LED indicators on some models

Part #	Description	Controls
USC-SWL	remote wall plate switch with LED status indicators	USC-6R
USC-KL	remote wall plate keyswitch with LED status indicators	USC-6R
USC-SW	remote wall plate switch (no LEDs)	MPR-SEQA MPR-SEQ-1CA PDS Series USC-6R
USC-K	remote wall plate keyswitch (no LEDs)	
K-DEC*	remote Decora® mount keyswitch (no LEDs)	
S-DEC*	remote Decora® mount switch (no LEDs)	
USC-KEY	additional set of keys for USC-KL or K-DEC	-

*mounts ONLY in Middle Atlantic Products Decora® openings (panels and racks).



S-DEC

USC-K

Power Solutions

Our power solutions are engineered and designed to U.S. standards*



Power Mounting Brackets

PB-90 bracket orients power outlets on any vertical power strip to the front or back of the enclosure.

- Allows mounting of power strips alongside mounted equipment in wider WRK Series racks
- Use PB-5A brackets to mount Middle Atlantic Products power strips in AXS, Slim 5, RL, RLA and MK Series racks, or to the rackrail of any rack
- To mount in the SR & DWR Series wall racks, use PB-DWR brackets



PB-90



PB-XS

Part #	Description
PB-90	brackets mount vertical power to face front or back of any rack* (pair)
PB-5A	brackets to mount vertical power strips on rear rackrail (pair)
PB-DWR	brackets to mount vertical power strips in DWR & SR Series wall racks (pair)
PB-XS	bracket mounts PD-815SC and PD-815SC-NS power strips between rackrail

*Requires LBFR-5A-xx to mount inside Slim 5 or AXS Series Racks

Power Solutions

Our power solutions are engineered and designed to U.S. standards*





accessories

Middle Atlantic Products has the best selection of Rack System Accessories in the industry – in stock and ready for immediate shipment.

These great products add the finishing touches to rack installation appearance, but also maximize system utility and play an important role in system reliability and life.



All Middle Atlantic Products Accessories are:

- Purpose-designed for the application
- Manufactured to the highest quality standards

Shelves & Storage	190 - 203	Thermal Management	222 - 227
Custom Rackshelves	190 - 191	Rackmount Consoles	228
Adjustable & Sliding Shelves	192 - 193	Lighting	229
Rackshelves	194 - 197	Security Options & Covers	230 - 231
Media Player & Keyboard Shelves	198 - 199	Blank & Vent Panels	232 - 239
LCD Rackmounts & Other Shelves	200 - 201	Connector Panels	237 - 239
Rackmount Storage	202 - 203	Other Hardware & Accessories	240 - 245
Lever Lock™	206 - 207		
Cable Management	210 - 219		
Horizontal	210 - 213		
Vertical	214		
Cable Ducts & Chases	215 - 216		
Cable Ladder	217 - 218		
Accessories	219		



RSH Series Custom Rackshelves

Custom Rackshelves from Middle Atlantic are the first choice of professional installers for mounting and trimming non-rackmount components. With these innovative shelves virtually any component can be installed in a standard 483mm enclosure without modification. The result is a neatly-trimmed installation with a perfect fit and no gaps because the shelf is sized for the selected component and the face plate is custom cut to provide a perfect opening.

- 1-2 day lead time
- Assembles easily in minutes
- Includes rear brackets to keep components from sliding backward
- Fully ventilated ears and bottom
- Choice of durable powder coat, brushed or anodized finishes
- Depths are automatically provided in 292mm, 356mm, 394mm, 445mm, or 521mm styles based on dimensions of your component
- Accepts any component up to 450mm wide
- Perfect fit both looks great and promotes proper thermal management
- Individual custom faces (less rack ears and shelf bottom) are also available
- LCD rackmounts also available
- Works great with rear-mount power like PD-815SC-PBSH on pg. 176

*Note: Custom faces do not work with standard shelves



Installation by Intra Home Systems

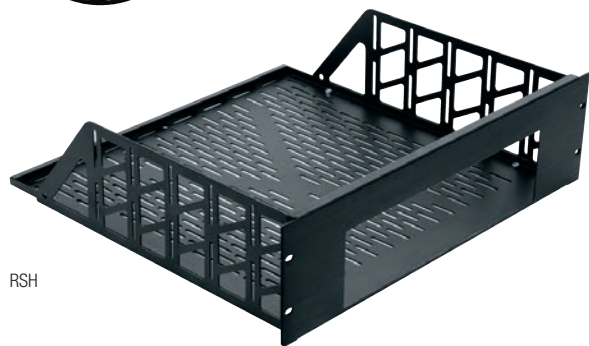

RSH



RSH with iPad®; database includes "in-wall" style docks for iPads and Control Systems



- Visit middleatlantic.com/resources/rsh-lookup.aspx



- Search the over 10K components on file



- Select your finish and place your order!

ordering instructions

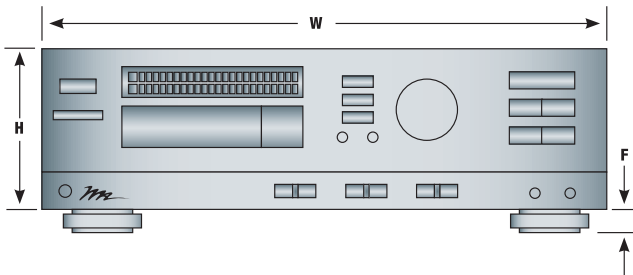

If your component is not on file, you can either send it to us for measurement or send us the dimensions as seen in the diagram. Contact customer service for assistance.*

*MUST be accurate within 1mm, depth can be within 3mm. The dimensions provided in the component's owner's manual are NOT always accurate. Please measure carefully as RSH units are custom-made and non-returnable.



Adjustable and Sliding Rackshelves

Middle Atlantic Products offers a wide range of adjustable and sliding shelves to support your project needs. Most models in this section are designed for 4-point mounting and are adjustable to fit a range of rack sizes. Note that unlike lower-quality offerings, Middle Atlantic shelves in this section include heavy-duty models designed with weight capacities up to 91kg for sliding models and 181kg for fixed models.



Sliding Shelf

Sliding shelves allow for easy maintenance of your components right on the shelf, and access to connections and cabling from the front of the rack. Middle Atlantic offers several styles of sliding shelves, including low profile, standard and heavy-duty to meet project needs and budgets.

- Adjustable 4-point mounting to fit in many rack models
- SS and SSHD-28 models include cable tie points at rear of shelf

Part #	Racking Height	Shelf Area	Material	Base	Rear Ear Adjustable Range	Shelf Extension	Weight Capacity
SS	36mm (less than 1 space)	445mm w x 375mm d	black powder coat, steel	solid	403mm – 595mm	356mm	23kg
SSL	36mm (less than 1 space)	425mm w x 356mm d	black laminate	solid	403mm – 595mm	289mm	16kg
SSHD-28	89mm (2 space)	429mm w x 711mm d	black powder coat, steel	vented	533mm – 762mm	711mm	91kg

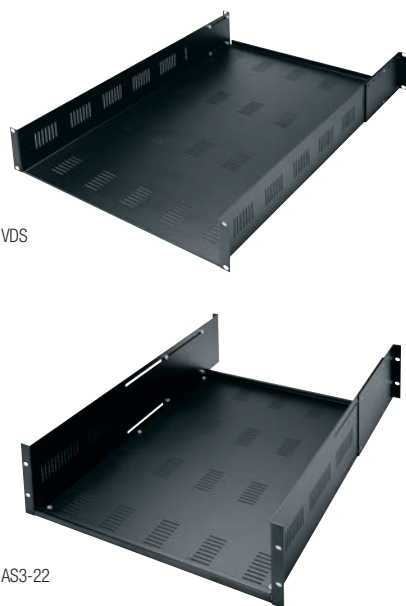

Adjustable Rackshelf

These vented 4-point mounting shelves were designed specifically for heavy equipment and adjust to allow 4-point mounting in many available rack depths.

- Partially vented bottoms to allow some cooling airflow
- Weight capacity up to 136kg, depending on model
- Steel construction with durable powder coat finish

Part #	Racking Height	Shelf Area	Weight Capacity
VDS	89mm (2 rackspace)	441mm w x 648mm d	45kg
AS3-22	133mm (3 rackspace)	441mm w x 546mm d	136kg



Heavy-Duty VTR/CPU Sliding Shelf

This full extension lockout shelf system was designed to hold VTRs in Broadcast applications, but can hold any similar equipment where access for maintenance or use is desired.

- Mounting ears are pre-installed for quick installation
- Adjustable 4-point mounting to fit in many rack models
- Optional front cover panel

Part #	Racking Height	Description	Area	Rear Ear Adjustable Range	Weight Capacity
SS4-23VTR	178mm (4 space)	sliding shelf	403mm w x 584mm d	318mm – 737mm	34kg
SS5-23VTR	222mm (5 space)	sliding shelf	403mm w x 584mm d	318mm – 737mm	34kg
SS-VTR-CVR4	178mm (4 space)	removable cover			
SS-VTR-CVR5	222mm (5 space)	removable cover			



SS-VTR



SS-VTR with cover

Telescoping Heavy-Duty Rackshelf

Unlike standard adjustable shelves, the entire VSA Series shelf telescopes to reach rear rail.

- 4-point mounting for a high 181kg weight capacity
- Fully vented bottoms with cable management tie points
- Steel construction with durable powder coat finish

Part #	Racking Height	Overall Depth	Weight Capacity
VSA-1626	38mm (less than 1 rackspace)	438mm w x 406mm (min.) to 660mm (max) d	181kg
VSA-2744	38mm (less than 1 rackspace)	438mm w x 686mm (min.) to 1118mm (max) d	181kg



VSA-1626



VSA-2744



Rackshelves

Middle Atlantic Products offers a wide range of adjustable and sliding shelves to support your project needs. Note that unlike lower-quality offerings, Middle Atlantic shelves in this section include heavy-duty models designed with weight capacities up to 91kg for sliding models and 181kg for fixed models.

- Choice of solid bottom and fully vented shelves
- Choice of ready-to-use and ready-to-assemble models
- Choice of models that accept optional clamps, or have clamps included
- Some popular models are available in Contractor packs
- All types are finished in a durable black powder coat



U1



U2V



U317



Contractor Pack sample

Utility Shelves

Utility shelves are a workhorse of installation, able to hold a wide range of equipment needed in the rack. Some models are also available in Contractor packs to save space and reduce packaging waste.

- Choice of solid bottom and fully vented shelves
- Choice of ready-to-use and ready-to-assemble models
- Choice of models that accept optional clamps, or have clamps included
- Some popular models are available in Contractor packs
- All types are finished in a durable black powder coat

Solid Part #	Vented Part #	Racking Height	Overall Depth	Useable Depth	Weight Capacity
U1	U1V	44mm (1 rackspace)	273mm	256mm	16kg
U2	U2V	89mm (2 rackspace)	370mm	365mm	23kg
U3	U3V	133mm (3 rackspace)	370mm	365mm	32kg
	U317*	133mm (3 rackspace)	370mm	365mm	32kg
U4	U4V	178mm (4 rackspace)	394mm	389mm	39kg

*partially vented, see image

Contractor and Master Packs

Contractor/master packs make storage and selection easy.

Part #	Type	Pack	Racking Height	Qty
U1-RP12	solid	contractor	44mm (1 rackspace)	12
U2-RP6	solid	contractor	89mm (2 rackspace)	6
U1MP	solid	master	44mm (1 rackspace)	50
U2MP	solid	master	89mm (2 rackspace)	50
U3MP	solid	master	133mm (3 rackspace)	36
U1V-4	vented	contractor	44mm (1 rackspace)	4
U2V-4	vented	contractor	89mm (2 rackspace)	4
U3V-4	vented	contractor	133mm (3 rackspace)	4
U4V-4	vented	contractor	178mm (4 rackspace)	4



Clamping Rackshelves

Clamping shelves captivate components with rubber-lined clamps from the top and adjustable rear brackets.

- Vented bottom
- UL Listed

Part #	Type	Racking Height	Clamp Height Range	Weight Capacity
CAP5	all ready-to-assemble	222mm (5 rackspace)	162mm - 206mm	45kg
CAP6	all ready-to-assemble	267mm (6 rackspace)	203mm - 251mm	45kg
CAP7	all ready-to-assemble	311mm (7 rackspace)	248mm - 295mm	45kg
CAP8	all ready-to-assemble	356mm (8 rackspace)	292mm - 340mm	45kg
RC-2	all assembled	89mm (2 rackspace)	25mm - 70mm	23kg
RC-3	all assembled	133mm (3 rackspace)	70mm - 117mm	32kg
RC-4	all assembled	178mm (4 rackspace)	114mm - 162mm	39kg

Part #	Description
PD-815SC-PBSH	PD slim series high density strip, 457mm long with surge & circuit breaker protection



CAP6



PD-815SC-PBSH rear mount power option available, see pg. 176

Ready-To-Assemble Rackshelves

Vented KD Series rackshelves ship ready-to-assemble to minimize freight costs & save storage space.

- Ear heights range from 2 to 6 spaces
- Sold in pairs
- All assembly hardware included
- UL Listed

Ear Part #	Racking Height	Depth	Weight Capacity
KDE2	89mm (2 rackspace)	394mm	23kg
KDE2S	89mm (2 rackspace)	292mm	23kg
KDE3	133mm (3 rackspace)	394mm	32kg
KDE3S	133mm (3 rackspace)	292mm	32kg
KDE4	178mm (4 rackspace)	394mm	39kg
KDE4S	178mm (4 rackspace)	292mm	39kg
KDE5	222mm (5 rackspace)	394mm	45kg
KDE6	267mm (6 rackspace)	394mm	45kg

Bottom Part #	Useable Shelf Area
KDB	441mm w x 384mm d
KDB-14*	441mm w x 346mm d
KDB-17.5	441mm w x 435mm d
KDB-20.5	441mm w x 511mm d

*fits our DWR Series (use w/ 'S' 292mm ears)

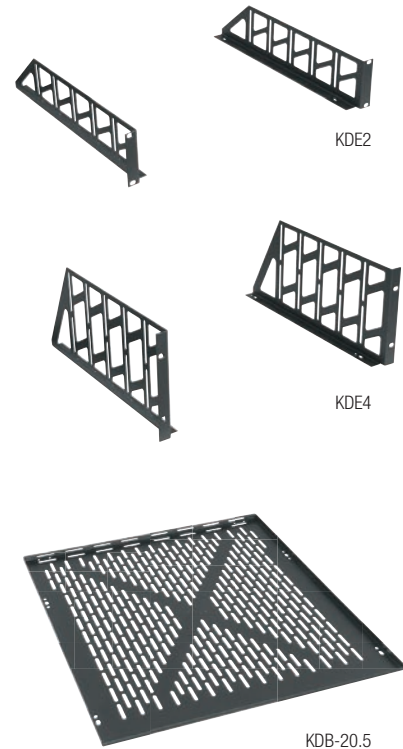

KDE2

KDE4

KDB-20.5



OCAP-2



VRS

Sat-Cable Box Rackshelves

These unique shelves use minimal shelf structure to provide the maximum open area around the supported component – ideal for high-heat components such as satellite and cable boxes. Perfect for installations with multiple video sources such as sports bars, gyms, and hotels.

- Universal fit accommodates most popular cable and satellite box sizes
- Sturdy steel construction with durable black powder coat finish
- OCAP Series: rubber-lined clamps on top and bottom
- VRS Series: holds up to 6 boxes vertically, eliminates need for individual shelves

Part #	Equipment Orientation	Racking Height	Depth	Weight Capacity	Useable Height
OCAP-2	horizontal	89mm (2 rackspace)	356mm	11kg	67mm
OCAP-3	horizontal	133mm (3 rackspace)	356mm	11kg	111mm
VRS	vertical	89mm (2 rackspace)	381mm	16kg	

Vented Center Mount Shelves for Open Frame Racks

This center-mount shelf was designed for use with 2-post racks but can be used with other racks to provide support in front of the rackrails. Front and rear edges have cable management tie points built in.

- Fully vented bottom aids equipment cooling
- Steel construction with durable powder coat finish

Part #	Racking Height	Useable Shelf Area	Weight Capacity
U2MS	89mm (2 rackspace)	438mm w x 457mm d	23kg

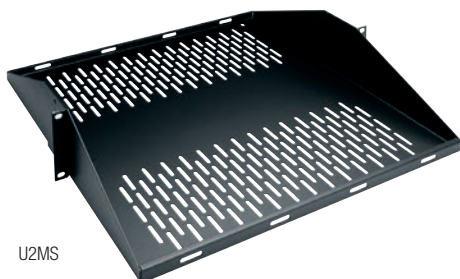

U2MS

Wide Unit Shelf System

Some components are too wide to fit the 441mm inside width of standard rackshelves. These shelf systems adjust to hold units up to 572mm wide.

- Fully vented bottom aids equipment cooling
- Steel construction with durable powder coat finish
- Saves room by requiring no rackspaces
- UL Listed

Part #	Useable Shelf Area	Weight Capacity
WUSS11.5	441mm (min.) to 575mm w x 289mm d	23kg
WUSS14*	441mm (min.) to 575mm w x 356mm d	23kg
WUSS15.5	441mm (min.) to 575mm w x 394mm d	23kg
WUSS17.5	441mm (min.) to 575mm w x 445mm d	23kg
WUSS20.5	441mm (min.) to 575mm w x 521mm d	23kg

*Available in 356mm depth - fits DWR Series and other shallow racks! NOTE: this rackshelf works with all Middle Atlantic enclosures except those that use 'Z-Rail.'

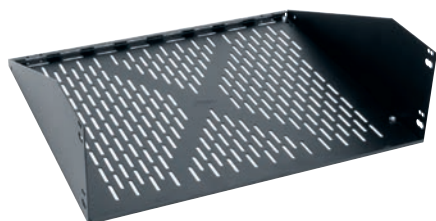

WUSS

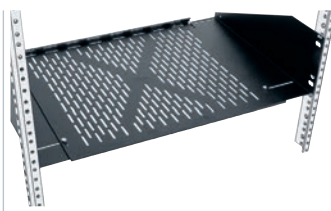

WUSS typical usage of mounting with adjustable width



Small Device Mounting Shelves

These innovative shelves are designed to mount multiple small devices while providing cable management and tie down points.

- Fully vented bottoms with flexible device mounting patterns
- Steel construction with durable powder coat finish

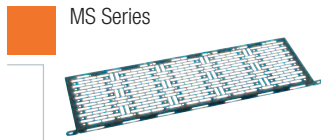

MS Series

- Holds small items in front or rear of rack

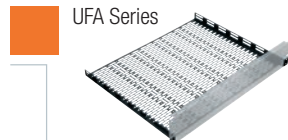

UFA Series

- Available faceplate that easily mounts after install to conceal devices

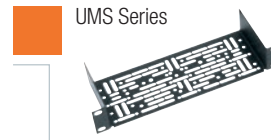

UMS Series

- Patented design includes counter sunk holes to match popular Extron® devices up to 483mm
- Available in half rack size



UTR Series

- Includes hook and loop strips for component mounting

Series	Part #	Type	Racking Height	Dimensions	Weight Capacity	Finish	Pre-Pack Qty	Included Panel	Contractor/ Master Pack
MS	MS-11	shelf		13mm h x 445m w x 280mm d	7kg	black powder coat	1		
	MS-11-4	shelf		13mm h x 445m w x 280mm d	7kg	black powder coat	4		
	MS-5.5	shelf		13mm h x 445m w x 140mm d	14kg	black powder coat	1		
	MS-5.5-4	shelf		13mm h x 445m w x 140mm d	14kg	black powder coat	4		
UFA	UFA-8	shelf	44mm (1 rackspace)	438mm w x 203mm d	16kg	black powder coat	1		
	UFA-8-4	shelf	44mm (1 rackspace)	438mm w x 203mm d	16kg	black powder coat	4		
	UFA-14.5	shelf	44mm (1 rackspace)	438mm w x 368mm d	11kg	black powder coat	1		
	UFA-14.5-4	shelf	44mm (1 rackspace)	438mm w x 368mm d	11kg	black powder coat	4		
	UFA-8-F1	shelf	44mm (1 rackspace)	438mm w x 203mm d	16kg	black powder coat	1	1 space	
	UFA-8-F2	shelf	89mm (2 rackspace)	438mm w x 203mm d	16kg	black powder coat	1	2 space	
	UFAF-1	panel	44mm (1 rackspace)			black powder coat	1		
	UFAF-1A	panel	44mm (1 rackspace)			black brushed and anodized	1		
	UFAF-2	panel	89mm (2 rackspace)			black powder coat	1		
	UFAF-2A	panel	89mm (2 rackspace)			black brushed and anodized	1		
	UFAF-3	panel	133mm (3 rackspace)			black powder coat	1		
	UFAF-3A	panel	133mm (3 rackspace)			black brushed and anodized	1		
UFAF-4	panel	178mm (4 rackspace)			black powder coat	1			
UFAF-4A	panel	178mm (4 rackspace)			black brushed and anodized	1			
UMS	HR-UMS1-11.5	half rack shelf	44mm (1 rackspace)	254mm w x 292mm d		black powder coat			
	HR-UMS1-3.5	half rack shelf	44mm (1 rackspace)	254mm w x 89mm d		black powder coat			
	HR-UMS1-5.5	half rack shelf	44mm (1 rackspace)	254mm w x 140mm d		black powder coat			
	UMS1-11.5	panel	44mm (1 rackspace)	448mm w x 292mm d	11kg	black powder coat			
	UMS1-11.5K	panel	44mm (1 rackspace)	448mm w x 292mm d	11kg	black powder coat		4 partial blank panels (1/4 & 1/2 width & 1/8 height) & hardware	
	UMS1-3.5	panel	44mm (1 rackspace)	448mm w x 89mm d	11kg	black powder coat			
	UMS1-3.5K	panel	44mm (1 rackspace)	448mm w x 89mm d	11kg	black powder coat		4 partial blank panels (1/4 & 1/2 width & 1/8 height) & hardware	
	UMS1-5.5	panel	44mm (1 rackspace)	448mm w x 140mm d	11kg	black powder coat			
	UMS1-5.5K	panel	44mm (1 rackspace)	448mm w x 140mm d	11kg	black powder coat		4 partial blank panels (1/4 & 1/2 width & 1/8 height) & hardware	
	UMSFP1-1/2	filler blank panel		42mm x 221mm		black powder coat			
	UMSFP1-1/4	filler blank panel		42mm x 110mm		black powder coat			
UMSFP1-1/8	filler blank panel		17mm x 110mm		black powder coat				
UTR	UTR1	shelf	44mm (1 rackspace)	254mm	11kg	black powder coat	50		UTR1MP
							12		UTR1-RP12



Universal Media Player Shelves

- Ships read-to-use
- Holds one or more docks
- Available accessory shelf



SH-DMP-S
does not include dock

Part #	Racking Height	Description	Finish
SH-DMP-A	178mm (4 space)	digital media player shelf	black brushed & anodized
SH-DMP-S	178mm (4 space)	digital media player shelf	black textured
SH-DMP-EXT		digital media player rear accessory shelf	

Front-Loading Media Holders

Store CDs, DVDs, and other recorded media in our rackmount media holders.

- Partitioned to prevent the contents from tipping
- All stored media protrudes 10mm to allow quick retrieval
- Flanged aluminum face
- Choice of black brushed and anodized or a textured black powder coat finish



DVD

Black Anodized Part #	Black Textured Part # with Lock	Fits	Racking Height	Depth
DVD		28 DVDs; PS3®, Xbox 360®, Wii® games; Blu-ray®, HD-DVD, DVD-Audio media	222mm (5 space)	140mm
CD	TCD	40 compact discs, SA-CD	178mm (4 space)	146mm
CD1		6 CDs	44mm (1 space)	140mm



Rackmount Computer Keyboard & Shelves

Rackmount computer keyboard systems occupy only 1 rackspace and include articulating arm to provide effective cable management. Finished in a durable black powder coat.

- The KB-SS is an adjustable sliding shelf universally designed to accommodate standard keyboards (405mm w x 238mm w)
- The RM-KB include a high quality full 101 key AT style keyboard with touchpad and padded wrist-rest

Part #	Description	Racking Height	Rear Adjustable Range
KB-SS	keyboard sliding shelf	44mm (1 rackspace)	432mm – 635mm
RM-KB	rackmount computer keyboard	44mm (1 rackspace)	432mm – 635mm



Fixed Writing/Computer Keyboard Shelves

The FWS fixed single bay writing/computer keyboard shelf bolts quickly to any rack to create a convenient work surface. Occupies 2 rackspaces below and comes complete with special rail-mounting hardware.

- Black laminate top work surface made from 19mm furniture-grade MDF board

Part #	Depth	Weight Capacity
FWS	457mm	45kg



FWS typical usage



RM-LCD-MK



RM-LCD-MT*
*monitor not included

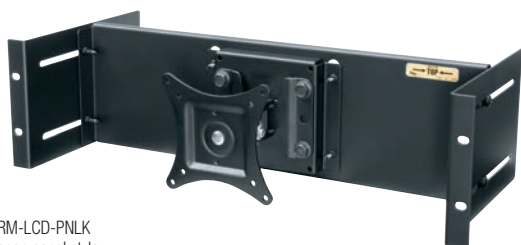

RM-LCD-PNLK
open panel style

LCD Rackmounts

Now it's easier than ever to rackmount LCD monitors! Middle Atlantic gives you a choice of five mounting styles, including fixed, tilting, and fully articulating models.

- Sturdy steel construction
- Generous front to back adjustment
- Versatile screen mounting using standard VESA 75 and VESA 100 patterns
- Holds LCD screen sizes from 381mm to 483mm, & some 508mm monitors

Part #	Racking Height	Style	Weight Capacity
RM-LCD-MV	400mm (9 rackspace)	backpan style, fixed mount	16kg
RM-LCD-MK	400mm (9 rackspace)	backpan style, tilt mount	16kg
RM-LCD-MT	400mm (9 rackspace)	backpan style, articulating mount	16kg
RM-LCD-PNLV	133mm (3 rackspace)	open panel style, fixed mount	16kg
RM-LCD-PNLK	133mm (3 rackspace)	open panel style, tilt mount	12kg

Wall Mount Shelf

Wall mounting non-rackmount components is much easier with our WMS wall mount shelf. Furniture version features attractive wooden side panels with rounded outside corners for safety.

- Vented bottoms
- Metal parts have durable powder coat finish

Part #	Finish	Weight Capacity
WMS-20	Black (steel)	91kg
WMS-1614NA	Napa	45kg
WMS-1614GS	Graystone	45kg
WMS-1614MP	Maple	45kg

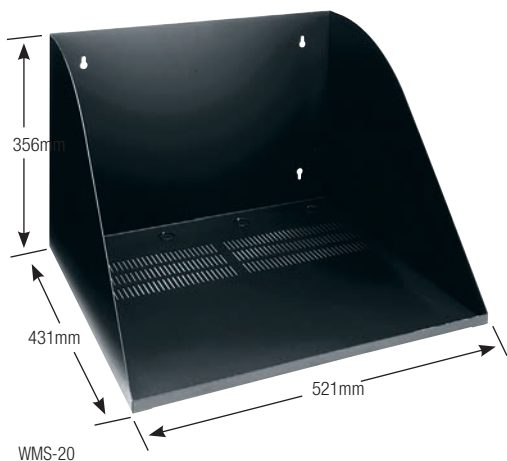

WMS-20

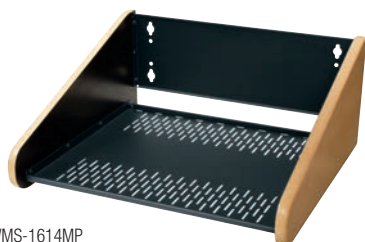

WMS-1614MP



Chassis Support Brackets

Chassis support brackets are a simple way to support heavy equipment within the rack and facilitates ventilation of high heat-generating equipment.

- Holds equipment without attaching the rack screws – ideal for fast swap outs
- Compatible with MRK, VRK, and VMRK when used with Z-rail or Z-rail adapter

Part #	Overall Depth	Pre-Pack Qty	Weight Capacity
CSA-18	257mm	2	45kg
CSA-20	508mm	2	45kg
CSA-20-H	508mm	2	91kg
CSA-22	559mm	2	45kg
CSA-22-H	559mm	2	91kg
CSA-24	610mm	2	45kg
CSA-24-H	610mm	2	91kg
CSA-26	660mm	2	45kg
CSA-26-H	660mm	2	91kg

NOTE: designed for mounting to Z-Rail or to a Z-Rail adapter - not compatible with standard L-shaped rackrail without hardware or rackrail adjustments



CSA typical usage

Rackmount Chassis

These chassis are ideal for holding your custom work. With its aesthetically-balanced, screwless flush-mounted faceplate, our Premium, CH Chassis, are equally at home in the back office or very visible locations. Economy model also available.

- Chassis disassemble easily for machining and access
- All models feature strong steel bodies
- Premium model has aluminum front and rear panels keep for easy machining

Model	Part #	Racking Height	Depth	Faceplate Finish
premium	CH1	44mm (1 rackspace)	254mm	anodized
premium	CH2	89mm (2 rackspace)	254mm	anodized
premium	CH3	133mm (3 rackspace)	254mm	anodized
economy	EC-1	44mm (1 rackspace)	152mm	black powder coat
economy	EC-2	89mm (2 rackspace)	152mm	black powder coat
economy	EC-3	133mm (3 rackspace)	152mm	black powder coat



CH1



EC-1

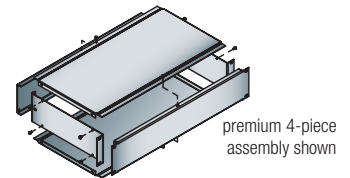

premium 4-piece assembly shown

Multi-Bay Laminate Work Surface

Designed to provide an ergonomic work space, work surfaces are available for select WRK, MRK and VRK Series enclosures. Offered in two, three, and four-bay sizes to span multiple ganged racks, these shelves feature an attractive 25mm thick graphite-marbled laminate surface with a durable black T-mold edging.

- Includes cable pass-through with grommets providing effective cable management
- Each work surface requires the use of two front and two rear rackspaces
- Sturdy steel tubing supports work surface

457mm Shelf Depth Part #	457mm Shelf Depth Part #	Span	Fits	457mm Shelf Depth Part #	457mm Shelf Depth Part #	Span	Fits
WS2-M26-18	WS2-M26-24	2 bay	MRK 660mm deep racks	WS2-W27-18	WS2-W27-24	2 bay	WRK 686mm deep racks
WS3-M26-18	WS3-M26-24	3 bay	MRK 660mm deep racks	WS3-W27-18	WS3-W27-24	3 bay	WRK 686mm deep racks
WS4-M26-18	WS4-M26-24	4 bay	MRK 660mm deep racks	WS4-W27-18	WS4-W27-24	4 bay	WRK 686mm deep racks
WS2-M31-18	WS2-M31-24	2 bay	MRK/VRK 787mm deep racks	WS2-W32-18	WS2-W32-24	2 bay	WRK 813mm deep racks
WS3-M31-18	WS3-M31-24	3 bay	MRK/VRK 787mm deep racks	WS3-W32-18	WS3-W32-24	3 bay	WRK 813mm deep racks
WS4-M31-18	WS4-M31-24	4 bay	MRK/VRK 787mm deep racks	WS4-W32-18	WS4-W32-24	4 bay	WRK 813mm deep racks

NOTE: not recommended for use on racks with casters



WS



Rackmount Storage

Middle Atlantic offers a broad selection of utility and special-purpose storage products to support your project needs. Many installers find that storing documents, manuals, or tools at the installation site increases efficiency and service speed. Models in this section include standard and heavy-duty drawers and lockboxes, as well as inserts for storing media and protecting sensitive contents.



D2-UMS-28



Universal Mounting Drawers

The universal mounting drawer was designed with our patented pattern to mount small devices traditionally located outside the rack to the bottom of the drawer.

- Smaller components typically mounted to the wall can now be mounted securely within the rack
- Bottom of drawer can be removed before installation to mount small devices and can be screwed into place
- Articulating cable arm keeps wires from getting pinched
- Pattern of holes and slots accommodates nearly any mounting hole pattern, and can also be used for wire tie or other cable fastening methods
- Provides abundant cable management and device tie down points
- Drawer locks for added security
- 4-point mounting for added strength
- Black powder coat finish

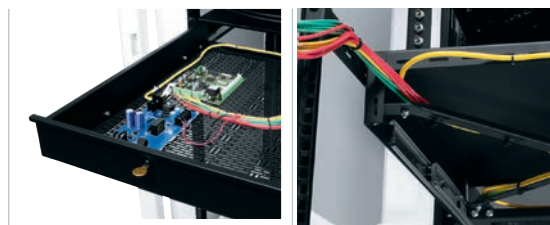

D2-UMS-28

articulating cable arm keeps wires from getting pinched when the drawer is pulled open or closed shut

Part #	Useable Mounting Area	Racking Height	Weight Capacity
D2-UMS-28	330mm w x 533mm d	89mm (2 space)	20kg

Heavy Duty Drawers

These drawers have a fully enclosed top and generous inside dimensions measuring 403mm wide by 368mm deep. 2, 3 and 4 space models include drawer mat and rear cable grommet.

- Spring-loaded latches; installed keylock option available
- Steel construction with a 23kg weight capacity
- Choice of black textured or brushed and anodized face finish
- TD8FLK model includes file hanging kit
- UL Listed



D2



D4

Black Anodized Part #	Black Anodized Part # w/ Lock	Black Textured Part #	Black Textured Part # w/ Installed Lock	Racking Height
D2	D2LK	TD2	TD2LK	89mm (2 rackspace)
D3	D3LK	TD3	TD3LK	133mm (3 rackspace)
D4	D4LK	TD4	TD4LK	178mm (4 space)
D5	D5LK	TD5	TD5LK	222mm (5 space)*
			TD8FLK*	356mm (8 space)

*does not include drawer mat



Economy Utility Drawers

The UD Series drawers offer an economical rack storage solution. Full extension ball bearing slides extend a full 356mm to reveal inside dimensions measuring 403mm wide by 368mm deep.

- Face formed drawer pulls; user-installed latch & keylock options
- Black powder coat finish
- Steel construction with 23kg weight capacity
- UL Listed

Part #	Racking Height
UD1*	44mm (1 rackspace)
UD2	89mm (2 rackspace)
UD3	133mm (3 rackspace)
UD4	178mm (4 space)

* NOTE: UD1 does not accommodate a lock



UD2



UD4

Lockboxes

Safely secure gear in a rackmount LBX Series lockbox. 432mm interior width.

- Steel construction with 23kg weight capacity
- UL Listed

Part #	Racking Height	Overall Depth
LBX-3	133mm (3 space)	229mm
LBX-4	178mm (4 space)	229mm



LBX-3

Media Partitions for Drawers

Partition your D, TD, and UD-Series drawers for media storage or for storing small parts and miscellaneous hardware. Easy snap-together fit, black color.

Part #	Fits	Accommodates
DCDP	D4, TD4, UD4	103 CDs, SA-CD
DVDP	D4, TD4, UD4	40 DVDs; PS3®, Xbox 360®, Wii® games; Blu-ray®, HD-DVD, DVD-Audio media



DVDP

Additional Accessories for Drawers

DM

- No-slip drawer mat

KYLK

- User-installed UD keylock

LATCH

- User-installed UD latch

ACC-KEY

- Additional set of keys for drawers & lockboxes

FI-x*

- Customizable foam inserts for 2, 3 & 4 RU drawers

* Replace x w/ RU of drawer



lever lock™

Finally! A place to mount non-rackmount and small devices without sacrificing rackspace. Lever Lock™ is a unique and patented system that allows integrators to maximize space in a rack by mounting small devices in the “no man’s land” area between the rackrail and the side panel or rear. Also great for routing cables!

This tool-free system is comprised of plates and bars that can mount vertically and horizontally to

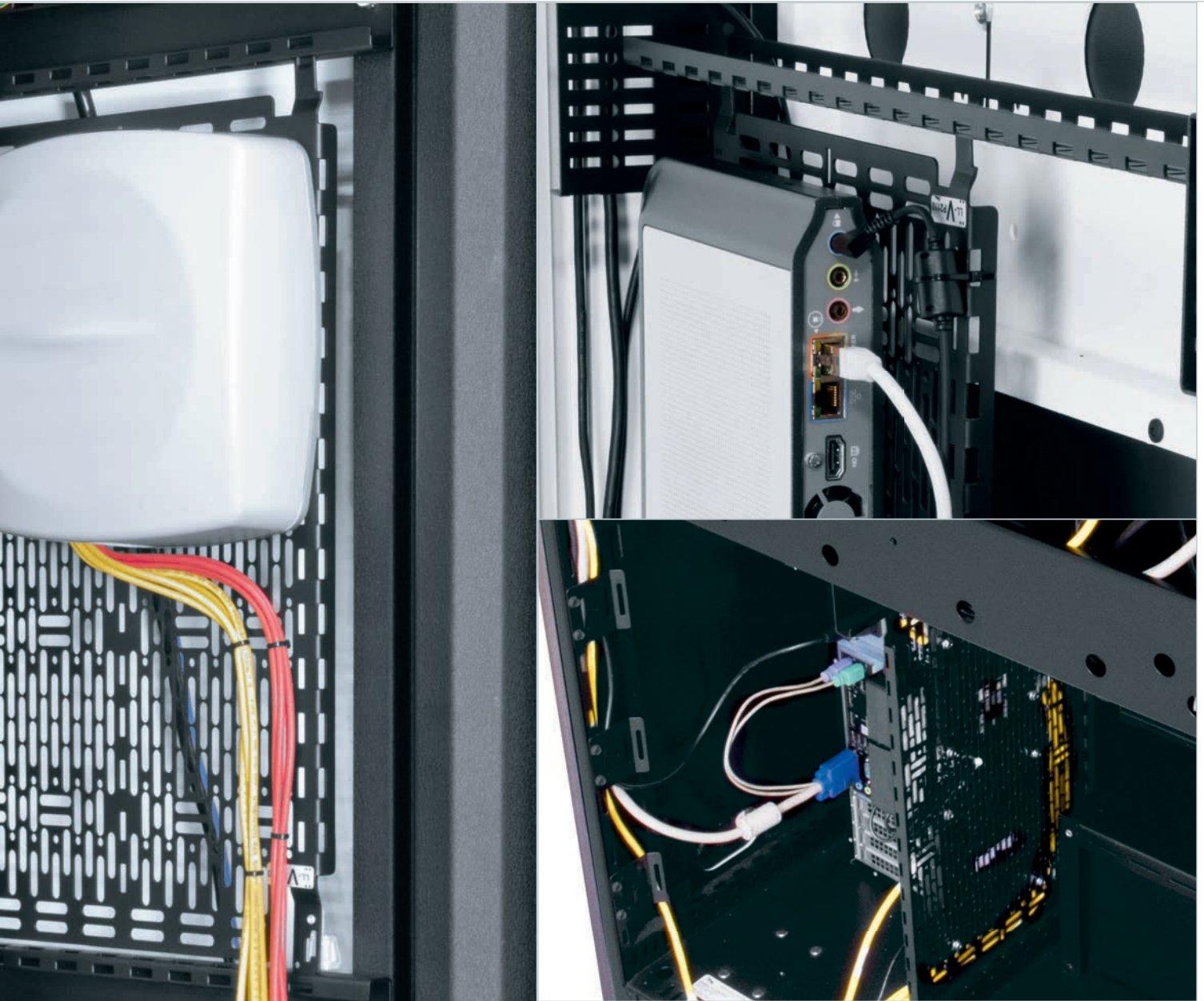

accommodate virtually any system. To date- over 9 product families accept Lever Lock and Middle Atlantic continues to add products each year. Just look for the “Lever Lock™ Ready” badge throughout the catalog or reference the chart on the following page.

Lever Lock™

206-207



Internal Management System

The patent-pending Lever Lock™ internal management system maximizes space utilization within a rack or furniture. Uniquely designed to facilitate Lever Lock™ cable management and device mounting within the rack through the use of unique tool-free bars and accessory mounting plates.

- Maximizes space within a rack or furniture system
- Universal mounting pattern accommodates most small devices
- Locks in place without tools in Lever Lock™ compatible products (see chart below)
- Offered in a variety of sizes for vertical and horizontal mounting

Part #	4 Pack Part #	Description
LL-H2A21		559mm long horizontal 51mm off-set angle
LL-H4A21		559mm long horizontal 102mm off-set angle
LL-HA21	LL-HA21-4	559mm long horizontal angle
LL-HC21	LL-HC21-4	559mm long horizontal channel
LL-HR21	LL-HR21-4	559mm long horizontal round
LL-VA17	LL-VA17-4	345mm long vertical angle
LL-VA21	LL-VA21-4	432mm long vertical angle
LL-VC17	LL-VC17-4	345mm long vertical channel
LL-VC21	LL-VC21-4	432mm long vertical channel
LL-VDIN17	LL-VDIN17-4	345mm long vertical DIN rail
LL-VDIN21	LL-VDIN21-4	432mm long vertical DIN rail
LL-VP1710		345mm long vertical 254mm deep plate
LL-VP2110		432mm long vertical 254mm deep plate
LL-MP21		7 piece multipack includes (2) LL-VC21, (4) LL-HA21, and (1) LL-VP2110

Products Accepting Lever Lock™	Pg.
BGR Series Racks	12
SNE Series Racks	14
BGR-MDK Series Racks	34
RFR Series Racks	96
DTRK Series Racks	110
L5 Series Lecterns	136
TechPed™ Technology Pedestal	138
VTC Series Video Carts	154
FlexView™ Video Carts	156

Look for the Lever Lock™ ready badge in the rack and furniture sections for compatible products.





use vertical channels or angles to lace cable bundles from top to bottom



mount horizontal lacer bars between vertical Lever Lock™ accessories, or between rackrail brackets for strain relief and cable management

designed to hold a wide range of standard DIN mount devices

offset lacer bars to relieve cable weight pressure on connections

vertical plates for small devices

install horizontal Lever Lock™ lacer bars on any location on rackrail brackets to provide offset cable management

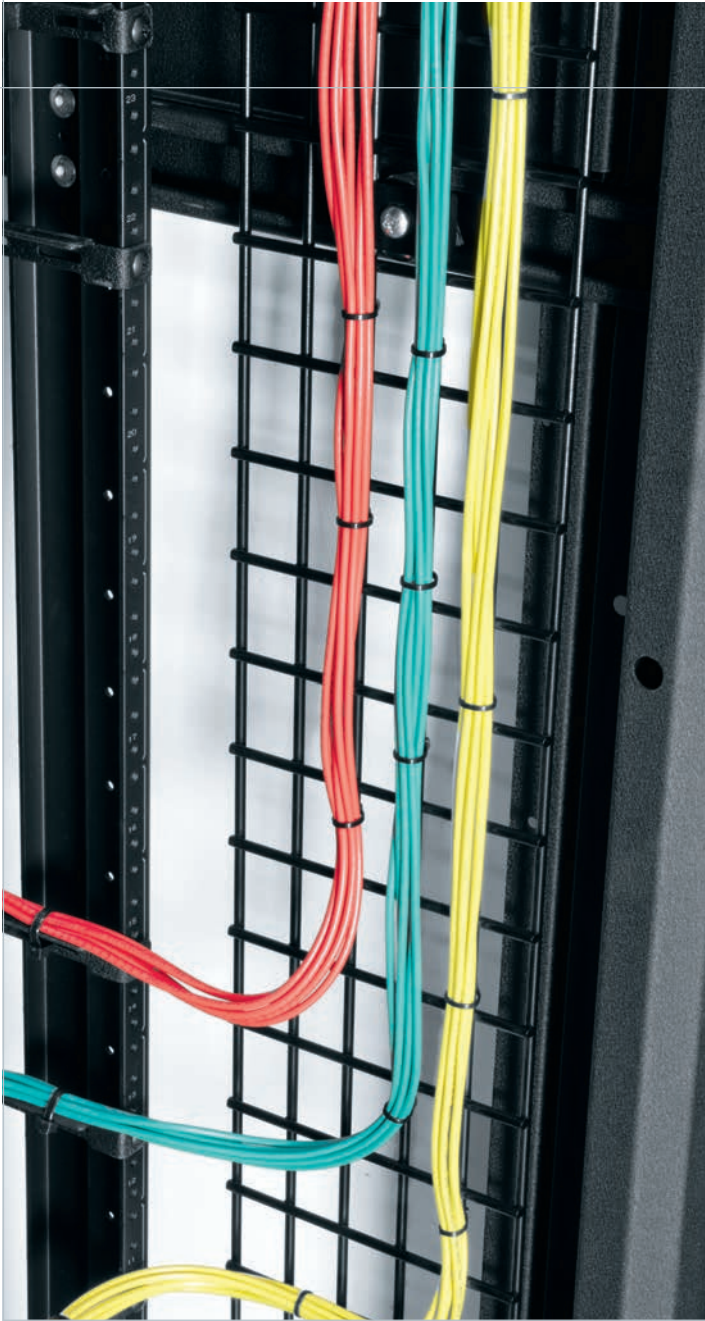

cable management

System needs for cabling & connectivity is growing exponentially. The more cables, the more critical it becomes to manage the cable entry, exit and within the enclosure to obtain a neat, organized system- but more importantly, allows for proper airflow & thermal management. Middle Atlantic Products offers a range of cable support products to meet any system needs including vertical & horizontal options, ducts, ladders and all the accessories.

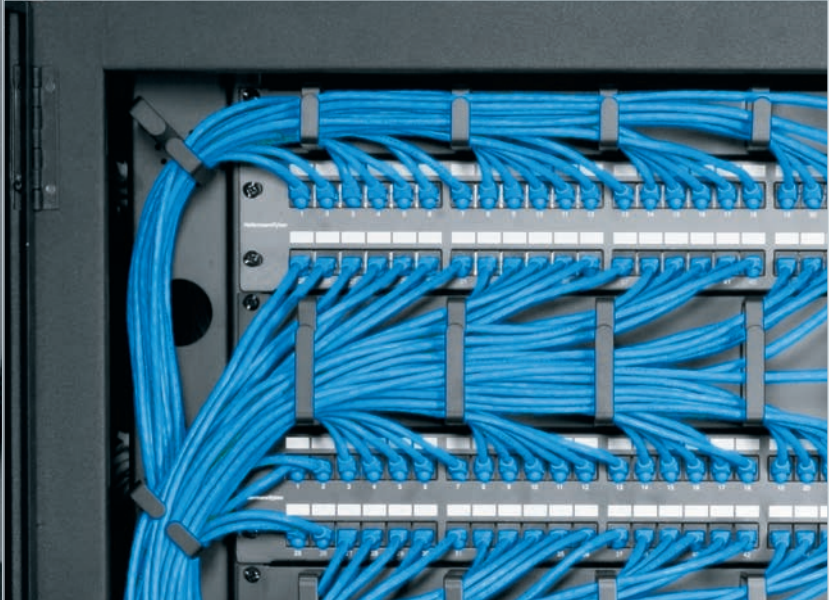

Horizontal Cable Management	210 - 213
Vertical Cable Management	214
Cable Ducts & Chases	215 - 216
Cable Ladders	217 - 218
Accessories	219



Horizontal Cable Management

Middle Atlantic Products offers a range of horizontal cable support products prevent cable strain by organizing and routing cables from rear component connections to the side of the rack.

LBP Series, Horizontal Lacer Bars

Horizontal lacer bars provide cabling support in the region of the mounted equipment itself, carrying cables horizontally from the sides of the rack to the connection points.

- Choice of round, rectangular, and "L" shaped profiles
- Choice of straight and offset styles
- Steel construction with black powder coat finish (except rectangular lacing bars of aluminum construction)
- Sold in packs of 10 pieces

Part #	Shape	Offset	Quantity
LBP-1S*	rectangular	–	10
LBP-1R	round	–	10
LBP-1R4	round	102mm offset	10
LBP-1.5	round	38mm offset	10
LBP-1.5R90	round	38mm offset	10
LBP-4R90	round	102mm offset	10
LBP-6R90	round	152mm offset	10
LBP-10R90	round	254mm offset	10
LBP-1A	L-shaped	–	10
LBP-2A	L-shaped	51mm offset	10
LBP-4A	L-shaped	102mm offset	10
LBP-6A	L-shaped	152mm offset	10

*aluminum construction

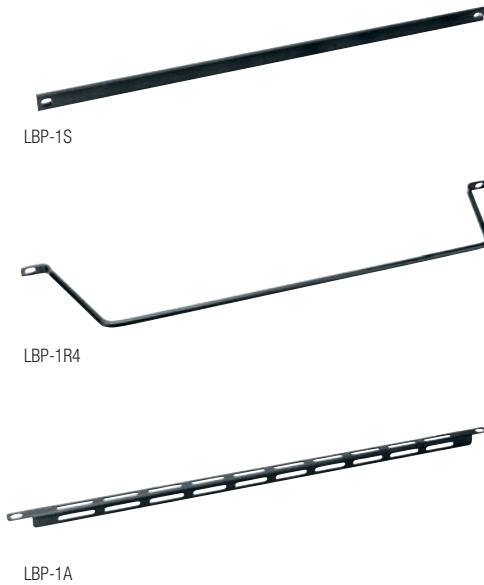

- cable management friendly hardware see pg. 240

LBP Series, Horizontal Lacer Bars

- For large amounts of cable or mounting small devices

Part #	Racking Height	Quantity	Panel Width
UP1	44mm (1 space)	1	483mm
UP1P	44mm (1 space)	10	483mm
LBP-LTF	89mm (2 space)	10	483mm

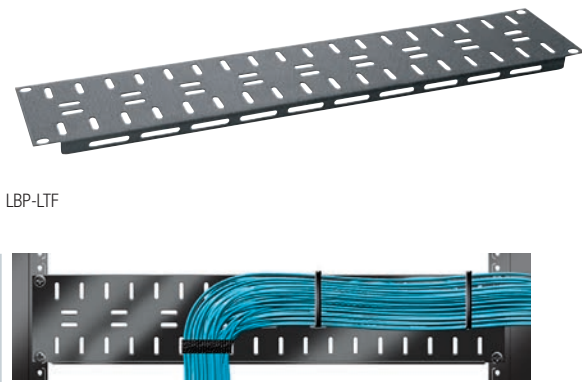



LB Series, Telescoping Lacer Bar System

Telescoping lacer bars are adjustable to meet the specific mounting requirements of various enclosures. Unique design accepts mounting of Middle Atlantic Products vertical power strips and vertical lacer strips.

- Choice of adjustable models for side-to-side (LBH products) and front-to-back support (LBFR products)
- LBFR-5A lacer bars have similar function but are fixed length
- Steel construction with black powder coat finish
- Sold in packs of 2

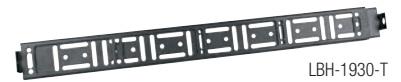

LBH-1930-T

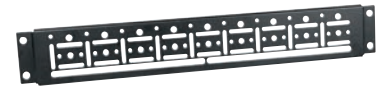

LBFR-5A-20

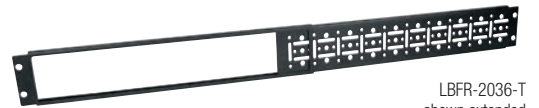

LBFR-2036-T
shown extended

Part #	Description	Telescoping Range (mounting hole to mounting hole)	Useable Depth of Rack (requires rear rackrail)	Height	Pre-Pack Quantity
LBH-1930-T	horizontal telescoping lacer bar	483mm to 762mm		44mm	2
LBFR-1626-T	front to rear telescoping lacer bar	406mm to 660mm	518mm to 695mm	73mm	2
LBFR-2036-T	front to rear telescoping lacer bar	508mm to 914mm	543mm to 949mm	73mm	2
LBFR-3650-T	front to rear telescoping lacer bar	914mm to 1270mm	949mm to 1305mm	73mm	2
LBFR-5A-16	front to rear lacer bar (fits SAX and SSAX racks)	368mm only	406mm	73mm	2
LBFR-5A-20	front to rear lacer bar (fits AXS, AX-SX, AX-SXR and SLIM 5 racks)	461mm only	508mm	73mm	2
LBFR-5A-26	front to rear lacer bar (fits AXS-26 and 660mm deep SLIM 5 racks)	613mm only	660mm	73mm	2

HCM Series, Horizontal Cable Managers

Organize patch cords and similar cabling while maintaining the a required bend radius. Available in a wide variety of styles to suit most applications. For optimal performance, do not exceed a 50% fill rate when passing cables through cable rings.

- Choice of styles including “D-ring” and “micro-clip”
- Choice of one and two space sizes
- Steel construction with black powder coat finish



HCM-1



HCM-2DV



D-RING

Part #	Description	Panel Width	Cable Rings Fill Area	End Rings Fill Area
HCM-1	44mm (1 rackspace) “micro-clip” style	483mm	22mm ²	
HCM-1V	44mm (1 rackspace) “micro-clip” style, w/ end D-Rings	483mm	22mm ²	190mm ²
HCM-1D	44mm (1 rackspace) “D-Ring” style	483mm	83mm ²	
HCM-1DV	44mm (1 rackspace) “D-Ring” style, w/ end D-Rings	483mm	83mm ²	190mm ²
HCM-2D	89mm (2 rackspace) “D-Ring” style	483mm	190mm ²	
HCM-2DV	89mm (2 rackspace) “D-Ring” style, w/ end D-Rings	483mm	190mm ²	190mm ²
HCM-1DR	44mm (1 rackspace) “D-Ring”, front & rear	483mm	159mm ²	
HCM-2DR	89mm (2 rackspace) “D-Ring”, front & rear	483mm	381mm ²	
D-RING	wall mount/ rackmount “D-Ring”		190mm ²	



HHCM shown open

HHCM shown closed

HHCM Series, Hinged Horizontal Cable Managers

Conceal patch cables while providing cable strain relief with the hinged horizontal cable managers.

- Hinged front panel has a magnetic closure
- Helps maintain the required bend radius
- Steel construction with black powder coat finish

Part #	Racking Height	Depth
HHCM-1	44mm (1 rackspace)	92mm
HHCM-2	89mm (2 rackspace)	92mm



PHCM typical

PHCM Series, Horizontal Cable Managers

Ample cable pass-throughs provided for dressing cables above, below, to the sides and behind the cable manager.

- Matches and integrates well with PCD Series duct pg. 216
- Available in single and 4-packs

Single Piece Part #	4 Pack Part #	Description
PHCM-1-2	PHCM-1-2-P4	1 rackspace (44mm) plastic finger horizontal cable manager, 51mm deep
PHCM-1-4	PHCM-1-4-P4	1 rackspace (44mm) plastic finger horizontal cable manager, 102mm deep
PHCM-2-3	PHCM-2-3-P4	2 rackspace (89mm) plastic finger horizontal cable manager, 76mm deep



HCT application

HCT Series, Horizontal Cable Tray

Handy horizontal cable tray mounts on any 483mm rack or cabinet and neatly routes cable bundles from side to side.

- Turn-downs on sides help maintain the required cable bend radius
- Steel construction with black powder coat finish

Part #	Racking Height
HCT-1	44mm (1 rackspace)
HCT-2	89mm (2 rackspace)



HCT-1



BR Series, Brush Grommet Cable Pass-Through Panel

The brush grommet panel provides a clean, organized cable entry method when mounted above any work surface. Also fits in opening on all MW Series top options.

- Built-in cable management tray
- Steel construction with black powder coat finish



BR1 application

Part #	Racking Height
BR1	44mm (1 rackspace)
BR2	89mm (2 rackspace)

PCS Series, Horizontal Fiber/ Cable Spools

These spools are designed to protect system performance by maintaining the bend radius of fiber and other high-speed cables within a rack or at a patching/distribution location.

- Ideal for managing excess fiber or copper cable slack within a rack
- Durable black resin construction
- 2 space panels include 2 spools which can rotate in 90° intervals
- 4 piece models include mounting hardware and brackets to make a complete circle



PCS-3-2H

Part #	Depth	Type
PCS-1-2H	35mm deep	2 space panel
PCS-1-4	35mm deep	4 pieces
PCS-3-2H	76mm deep	2 space panel
PCS-3-4	76mm deep	4 pieces



PCS spools



Vertical Cable Management

Middle Atlantic Products offers a range of vertical cable support products to prevent cable strain by organizing and routing cables along side the rack. Properly dressed installations not only look better, but better support the thermal management strategy and make ongoing maintenance and changes easier.



OWP Series
LACE-44-OWP



OP Series
LACE-40-OP



LP Series
LACE-44LP



P Series
LACE-P



1SP Series
LACE-44-1SP



1P Series
LACE-441P

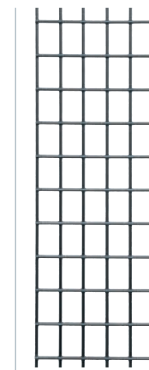

WB6 Series
LACE-WB6-24

Series	Part #	Racking Height	Width	Tie Points	Qty	Compatible Cable Management Options			
						Cable Ties	TWS Pg. 219	TW12 Pg. 219	Cage Nuts Pg. 240
OWP	LACE-5254-OWP	52-54 rackspaces	121mm	mixed slip-on posts, cage nut holes and round holes	6	✓	✓	✓	✓
	LACE-44-OWP	44 rackspaces	121mm	mixed slip-on posts, cage nut holes and round holes	6	✓	✓	✓	✓
	LACE-40-OWP	40 rackspaces	121mm	mixed slip-on posts, cage nut holes and round holes	6	✓	✓	✓	✓
	LACE-37-OWP	37 rackspaces	121mm	mixed slip-on posts, cage nut holes and round holes	6	✓	✓	✓	✓
	LACE-23-OWP	23 rackspaces	121mm	mixed slip-on posts, cage nut holes and round holes	6	✓	✓	✓	✓
	LACE-13-OWP	13 rackspaces	121mm	mixed slip-on posts, cage nut holes and round holes	6	✓	✓	✓	✓
OP	LACE-5254-OP	52-54 rackspaces	83mm	mixed slip-on posts, cage nut holes and round holes	6	✓	✓	✓	✓
	LACE-44-OP	44 rackspaces	83mm	mixed slip-on posts, cage nut holes and round holes	6	✓	✓	✓	✓
	LACE-40-OP	40 rackspaces	83mm	mixed slip-on posts, cage nut holes and round holes	6	✓	✓	✓	✓
	LACE-37-OP*	37 rackspaces	83mm	mixed slip-on posts, cage nut holes and round holes	6	✓	✓	✓	✓
	LACE-23-OP	23 rackspaces	83mm	mixed slip-on posts, cage nut holes and round holes	6	✓	✓	✓	✓
	LACE-13-OP	13 rackspaces	83mm	mixed slip-on posts, cage nut holes and round holes	6	✓	✓	✓	✓
LP	LACE-37LP	37 rackspaces	89mm	raised cable tie points	6	✓		✓	
	LACE-44LP	44 rackspaces	89mm	raised cable tie points	6	✓		✓	
P	LACE-P	45 rackspaces	51mm	round holes	6	✓	✓		
	LACE-37P	37 rackspaces	51mm	round holes	6	✓	✓		
	LACE-13P	13 rackspaces	51mm	round holes	6	✓	✓		
1SP	LACE-44-1SP	44 rackspaces	25mm	10 pre-installed tie saddles	6	✓	inc.	✓	
1P	LACE-44-1P	44 rackspaces	25mm	tie saddles	6	✓	✓		
	LACE-37-1P	37 rackspaces	25mm	tie saddles	6	✓	✓		
WB6	LACE-WB6-24	24 rackspaces	152mm	vertical wire grid lace	1				
	LACE-WB6-42	42 rackspaces	152mm	vertical wire grid lace	1				
	LACE-WB6-45	45 rackspaces	152mm	vertical wire grid lace	1				



External Vertical Cable Ducts

Every model has plenty of cable egress points for control of cable locations and bend radius. Plastic models are economical and fingers can be easily removed for larger bundle exit. Metal models are sturdy steel construction for years of dependable service.

VCD Series, Vertical Steel Wire Cable Ducts

Designed to organize and protect cabling next to or between racks. Smooth, steel cable fingers are placed in rackspace increments for complete control of access locations.

- Organizes cable pathways while protecting bend radius
- Choice of single and dual duct (front and rear channels)
- Sturdy all-steel construction with black powder coat finish, incl. locking steel doors
- UL Listed

254mm Wide Part #	152mm Wide Part #	Description	All VCD Ducts Work with	
VCD-10-51-SC	VCD-6-51-DC	2438mm (51 rackspace) single cable duct system	MK & RL Series	pg. 116 & 118
	VCD-6-45-DC	2134mm (45 rackspace) dual cable duct system	RLA Series	pg. 118
VCD-10-45-SC	VCD-6-45-SC	2134mm (45 rackspace) single cable duct system	R4 Series	pg. 114



VCD-10-45-DC

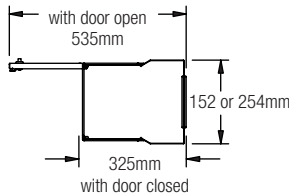

single duct dimensions

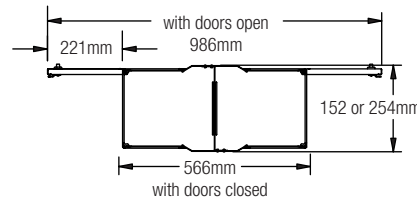

dual duct dimensions



sturdy metal fingers designed to provide support with generous capacity

RLA-CC Series, Vertical Cable Duct with Hinged Door

- Solid hinged front door with 3-point magnetic latch

Part #	Description	All RLA-CC Ducts Work with
RLA-CC*	2134mm (45 space) duct with hinged cover	45 space MK, R2, RL, RLA and R4 Series

*Order 2 single ducts to make an economical dual channel organizer

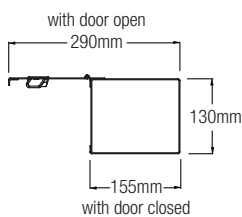

RLA-CC

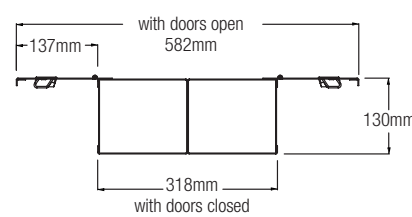

2 RLA-CC's mounted back to back



RLA-CC features a full-length hinged access door

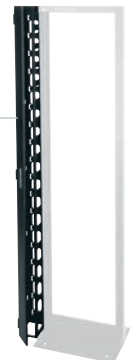

R2-44S shown with RLA-CC

CK Series, Vertical Steel Cable Ducts

- Includes convenient cable lacing points
- Mounts on MK, RL, RLA, R2 and R4 Series
- Optional split lift-off covers enhance appearance and block dust
- Rugged steel construction with black powder coat finish

Part #	Description
CK-45	45 rackspace center organizer
CK-45E	45 rackspace end organizer
CK-45C	45 rackspace split, lift-off cover - 2 pieces



CK-45 application



PCD single duct



PCD-1.5X2-4BK

PCD Series, Vertical Plastic Cable Ducts

Plastic cable ducts provide a cost-effective solution for protecting, routing, and organizing cables and cords.

- Slotted plastic finger design for horizontal cable access exactly where needed
- Fingers can easily be removed to create larger openings
- Plastic covers are included
- Matches and integrates well with PHCM Series horizontal cable managers pg. 212

Part #	Racking Height	Size	Type	Application
PCD-2-3-8SC	8 rackspaces	51mm w X 76mm d	single	mounting to small, open frame wall racks like SFR Series (pg.70)
PCD-2-3-12SC	12 rackspaces	51mm w X 76mm d	single	
PCD-2-3-15SC	15 rackspaces	51mm w X 76mm d	single	
PCD-2-3-20SC	20 rackspaces	51mm w X 76mm d	single	
PCD-2-3-25SC	25 rackspaces	51mm w X 76mm d	single	
PCD-2-3-30SC	30 rackspaces	51mm w X 76mm d	single	mounting to side and/or between 2- and 4- post racks (pg. 114 - 119)
PCD-2-3-38SC	38 rackspaces	51mm w X 76mm d	single	
PCD-3-3-38SC*	38 rackspaces	76mm w X 76mm d	single	
PCD-3-6-38DC*	38 rackspaces	76mm w X 152mm d	dual	
PCD-4-4-38SC*	38 rackspaces	102mm w X 102mm d	single	
PCD-4-8-38DC*	38 rackspaces	102mm w X 203mm d	dual	
PCD-2-3-45SC	45 rackspaces	51mm w X 76mm d	single	
PCD-3-3-45SC*	45 rackspaces	76mm w X 76mm d	single	
PCD-3-6-45DC*	45 rackspaces	76mm w X 152mm d	dual	
PCD-4-4-45SC*	45 rackspaces	102mm w X 102mm d	single	
PCD-4-8-45DC*	45 rackspaces	102mm w X 203mm d	dual	
PCD-2-3-51SC	51 rackspaces	51mm w X 76mm d	single	mounts behind rackrail
PCD-1.5X2-4BK	plastic cable duct with cover, 38mm w x 51mm d x 1829mm, qty. of 4,			
PCD-1.5X4-4BK	plastic cable duct with cover, 38mm w x 102mm d x 1829mm, qty. of 4,			
PCDB-90-1.5-12	brackets to mount plastic cable ducts, orients duct to face front/rear of rack, qty. of 12			

*Plastic cable ducts can mount in between two racks, for 38 rackspace and higher sizes only



CC-44-312

CC Series, Vertical Steel Wire Cable Ducts

Steel cable chases are designed for use between ganged racks to provide ample space for routing cables.

- 102mm width provides ample space for cable routing
- Steel construction with black powder coat finish
- Accept SPN Series side panels
- Custom width chases available, call for details
- Kits include front & rear vertical channels and solid top cover

	Part #	Kit Description	Fits
Kits	CC-40-267	1778mm (40 Space) cable chase	WRK-40-27, MRK-4026
	CC-40-312	1778mm (40 Space) cable chase	WRK-40-32, MRK-4031
	CC-44-36	1956mm (44 Space) cable chase	MRK-4436, DRK19-44-36, VRK-44-36H
	CC-44-312	1956mm (44 Space) cable chase	WRK-44-32, MRK-4431, VRK-44-31H, DRKXX-44-31
	CC-44-267	1956mm (44 Space) cable chase	WRK-44-27, MRK-4426
	CC-44-423	1956mm (44 Space) cable chase	MRK-4442, DRKXX-44-42



Cable Ladders

Cable ladder systems are the gold standard for managing cable-heavy installations. Middle Atlantic offers a complete cable ladder system to keep large overhead bundles neat and organized while preventing unnecessary cable strain.

A complete line of fully welded cable ladders. Cable ladder sections ship fully boxed, which minimizes product damage and simplifies shipping and storage. Highly durable finish consists of 2 layers of black powder coat and is exceptionally scratch resistant. Compatible with most popular brands and accessories of cable ladders, these will work on both new and retrofit installations.

- Available in 305mm, 457mm, and 610mm widths
- UL Listed

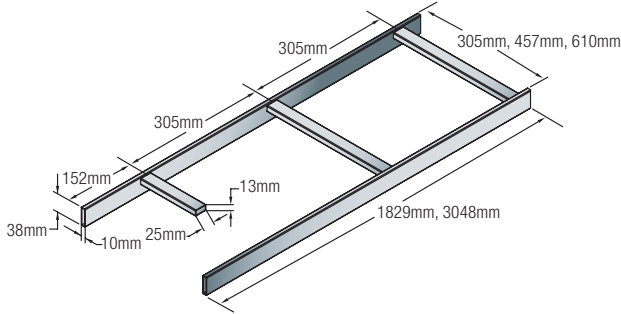
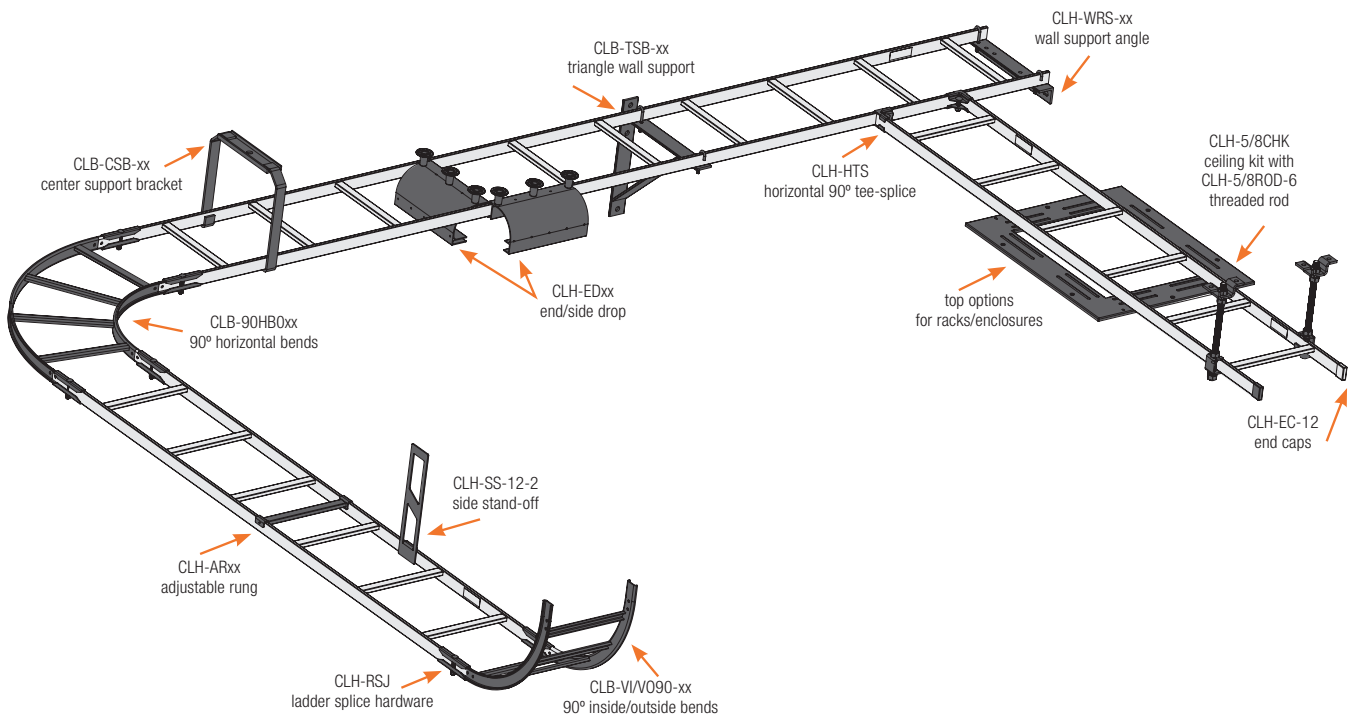



Cable Ladder Hardware and Accessories

- A complete line of splice hardware, cable ladder drops, support brackets, and other compatible fittings to complete a cable support ladder installation

Ladder Sections



305mm Wide Bulk Packs	305mm Wide Part #	457mm Wide Part #	610mm Wide Part #	Description
CLB-6-12 (12 pieces)	CLB-6	CLB-6-W18	CLB-6-W24	1829mm long straight ladder section, black
CLB-10-12 (12 pieces)	CLB-10	CLB-10-W18	CLB-10-W24	3048mm long straight ladder section, black
	CLB-90HB	CLB-90HB-W18	CLB-90HB-W24	90° horizontal bend, black
	CLB-VI90	CLB-VI90-W18	CLB-VI90-W24	90° vertical inside bend, black
	CLB-VO90	CLB-VO90-W18	CLB-VO90-W24	90° vertical outside bend, black

Wall/Ceiling Mounts - black finish

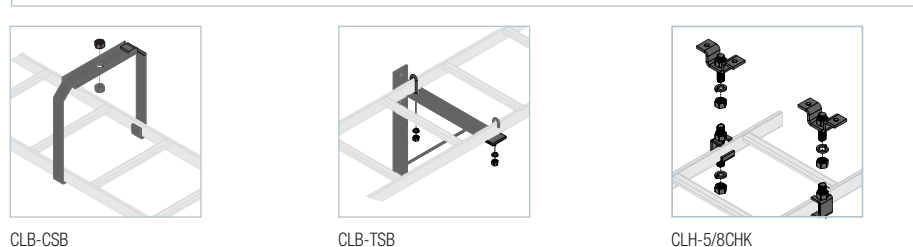

305mm Wide 6 Packs	305mm Wide Part#	457mm Wide Part#	610mm Wide Part#	Description
CLB-CSB-6	CLB-CSB	CLB-CSB-W18	CLB-CSB-W24	center support bracket
CLB-TSB-6	CLB-TSB	CLB-TSB-W18	CLB-TSB-W24	triangle wall support bracket
CLH-WRS-6	CLH-WRS or CLH-WRS-W6-W12	CLH-WRS-W18-W24	CLH-WRS-W18-W24	ladder wall support angle
CLH-5/8CHK-6	CLH-5/8CHK	CLH-5/8CHK	CLH-5/8CHK	16mm slotted ceiling kit, fits all widths
	CLH-5/8ROD-12-4	CLH-5/8ROD-12-4	CLH-5/8ROD-12-4	305mm long section 16mm threaded rod, 4 pieces
	CLH-5/8ROD-6	CLH-5/8ROD-6	CLH-5/8ROD-6	1829mm long section 16mm threaded rod, 1 piece
CLH-RES-6	CLH-RES	CLH-RES	CLH-RES	ladder end support hardware, fits all widths
CLH-RWC-6	CLH-RWC	CLH-RWC	CLH-RWC	ladder wall clamp, fits all widths

Junction & Splice Hardware - black finish

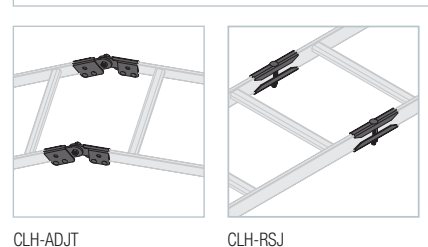

Part #	Quantity	Description
CLH-ADJH	1 pair	adjustable horizontal splice hardware
CLH-RSJ	1 pair	ladder end splice hardware
CLH-RSJ-6	6 pairs	ladder end splice hardware
CLH-HTS	1 pair	horizontal 90° tee splice hardware
CLH-HTS-6	6 pairs	horizontal 90° tee splice hardware
CLH-ADJT	1 pair	adjustable ladder end splice hardware
CLH-90T	1 pair	adjustable 90° tee splice hardware

Side, End Drops and Adjustable Rungs

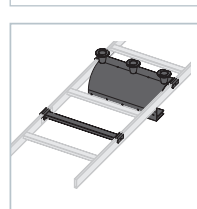

305mm Wide Bulk Packs	305mm Wide Part#	457mm Wide Part#	610mm Wide Part#	Description
	CLH-AR12	CLH-AR18	CLH-AR24	adjustable rung (no drop)
	CLH-ARD12	CLH-ARD18	CLH-ARD24	adjustable rung drop with spools
CLH-ED11-4	CLH-ED11	CLH-ED17	CLH-ED23	end drop with spools
	CLH-ED5	CLH-ED5	CLH-ED5	127mm wide end drop with spools, fits all widths
	CLH-ED8	CLH-ED8	CLH-ED8	203mm wide end drop with spools, fits all widths
CLH-SD8-4	CLH-SD8	CLH-SD8	CLH-SD8	203mm wide end drop with spools, fits all widths

Accessories

Part #	Description
CL-GK	cable ladder bonding kit
CLH-EC-12	cable ladder end caps (12 pieces)
CLH-JBOLT	8mm J-bolts and nuts (1 pair)
CLH-SPOOL-10	cable management spools (10 pieces)
CLH-5/8ROD-12-4	305mm long section 16mm threaded rod, 4 pieces
CLH-5/8ROD-6	1829mm long section 16mm threaded rod, 1 piece
CLH-SS-12-2	305mm high, side stand-off, 2 pieces
CLH-ELS5/7	cable ladder elevation kit, 127-178mm
CLH-ELS8/12	cable ladder elevation kit, 203-305mm
CLH-ELS13/18	cable ladder elevation kit, 330-457mm
MK-LA	ladder adapter kit for MRK-19-45-RL and RLA Series
MW-LA	top option for DRK, MRK, WRK, VRK and VMRK Series enclosures



Cable Management Accessories

Products in this section provide additional support and protection to cable management systems.

Cable Management Straps

Reusable cable management straps are made from Velcro® and are perfect for managing cables that are sensitive to strain. This is because they are wider and softer than common wire ties, and therefore are less likely to cause pinching damage to the cables.

- Wide straps fasten cables without pinching
- Genuine Velcro® construction
- Straps are 203mm long
- Sold in packs of 12 pieces

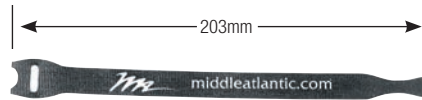

TW12

Part #	Description	Quantity
TW12	203mm cable/wire management Velcro® straps	12

Protective Grommets

Grommets protect cables passing through knockouts or any possible pinch point.

- Protects cables when passing sharp edges
- Available in several styles to match rack knockouts
- Flexible grommet material can also be used on most metal edges up to 3mm thick



GK4 grommet ring

Part #	Description	Quantity
GK-1X7G	25mm x 178mm gland grommet ring	4
GK-3G	76mm gland grommet ring	4
GK-4G	102mm gland grommet	4
GK4	102mm grommet ring	4
GR-30	Flexible black grommet material	9144mm



GR-30



GK-4G gland grommet

Cable Claw Cable Hanger

The unique dual-size “claw” configuration of this versatile wall mount cable hanger provides efficient storage for all cables large and small.

- Hanging cable storage is fast and convenient
- Available with or without side trays for storing small items
- Steel construction with black powder coat finish

Part #	Dimensions
CLAW	406mm w x 89mm d, with side trays
CLAW14	356mm w x 89mm d

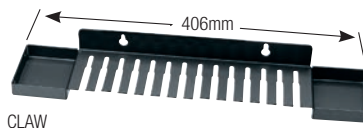

CLAW

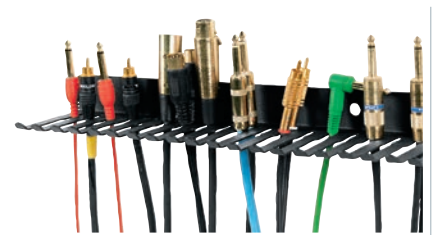

CLAW application

Brackets and Tie Points

Middle Atlantic offers several handy bracket and tie point models that can be used to secure cables

Part #	Description	Quantity
CMB-6	cable manager brackets	6
TSW-15	cable tie saddle	15



CMB-6



TSW-15 application



thermal management

Thermal Management plays a critical role in overall system reliability because heat has been proven to substantially reduce the service life of most equipment. Maintaining the recommended constant operating temperature for most equipment (max 85°) will help provide a long service life for the equipment inside an enclosure. Why 85°? Most studies have shown that for every 10° rise, digital equipment life is reduced by approximately 40%!



Middle Atlantic offers a wide range of cooling products to meet the needs of nearly any environment. We offer a full selection of quiet, thermostatic and proportionally controlled cooling options that save energy.



IUQFP/UQFP Series, Ultra Quiet Fan Panels

These award-winning premium cooling panels are quiet and effective. Ideal for cooling smaller systems in visible locations such as living spaces and AV studios. Designer versions also feature dimmable displays and have a black brushed and anodized finish.

- Compact two-space size saves rackspace
- Thermostatic, proportional speed fan control is quiet and saves energy
- Includes local and remote overtemp notification for system reliability
- Choice of black powder coat or black brushed and anodized finish

Certifications

- CE

Power Solutions



100VAC – 2240VAC | 50/60Hz Compatible



UQFP-4D



UQFP-4RT



IUQFP-4DRA
designer look and finish

120V Part #	240V Part #	Racking Height	# of Fans	Overtemp Notification			User Definable Overtemp Setting	Fan Failure Notification Local & Remote Display	Free Air Rating	Max Sound Level	Finish	Aesthetics
				Local LED	Local Display	Remote						
UQFP-2	IUQFP-2	89mm (2 space)	2	✓	-	✓	-	-	50 CFM	24 dB	black powder coat	basic
UQFP-2D	IUQFP-2D	89mm (2 space)	2	✓	✓	✓	✓	✓	50 CFM	24 dB	black powder coat	basic
UQFP-4	IUQFP-4	89mm (2 space)	4	✓	-	✓	-	-	100 CFM	27 dB	black powder coat	basic
UQFP-4D	IUQFP-4D	89mm (2 space)	4	✓	✓	✓	✓	✓	100 CFM	27 dB	black powder coat	basic
UQFP-4DRA	IUQFP-4DRA	89mm (2 space)	4		dimnable	✓	✓	✓	100 CFM	27 dB	black, brushed & anodized	designer
UQFP-4RA	IUQFP-4RA	89mm (2 space)	4			✓			100 CFM	27 dB	black, brushed & anodized	designer
UQFP-4RA-I/O**		178mm (4 space)**	8						100 CFM	30 dB	black, brushed & anodized	designer
UQFP-4RIS***		89mm (2 space)	4						100 CFM	27 dB	black, brushed & anodized	designer
UQFP-4RT		89mm (2 space)	4						100 CFM	27 dB	black powder coat	basic

Includes two fan panels (one for intake, one for exhaust) plus connecting cable *Intake unit can be added to existing UQFP installations



QFP Series, Quiet Fan Panels/Assemblies

These fan panel assemblies provide quiet cooling for demanding environments.

- Occupies 3 rackspaces
- Comes complete with fan(s) and grille(s) installed; cord and plug included
- Choice of black powder coat or black brushed and anodized finish



QFP-1



QFP-2

Power Solutions



100VAC

120V Anodized Part #	120V Textured Part #	240V Anodized Part #	240V Textured Part #	# of Fans	Free Air Rating	Racking Height	Max Sound Level
QFP-1	QTFP-1	QFP-1-119	QTFP-1-119	1	50 CFM	133mm (3 spaces)	30 dB
QFP-2	QTFP-1	QFP-2-119	QTFP-2-119	2	100 CFM	133mm (3 spaces)	33 dB

QBP Series, Quiet Blower Panels

This unique product series from Middle Atlantic uses a pair of our custom-designed blowers to move up to 100 CFM of cooling air quietly in only one rackspace! Intelligent proportional speed control, and high static pressure to maintain airflow even through crowded rackspace.

- Compact one-space unit saves rackspace
- Choice of black powder coat or black brushed and anodized finish
- Half rack size available



QBP-2



HR-QBP-1

Certifications

- CE

Power Solutions



100VAC – 2240VAC | 50/60Hz Compatible

120V Part #	240V Part #	Black Finish	# of Blowers	Max Sound Level	Free Air Rating	Racking Height	Overall Width
QBP-2A	IQBP-2A	Anodized	2	32 dB	100 CFM	44mm (1 space)	483mm
QBP-2	IQBP-2	Flat	2	32 dB	100 CFM	44mm (1 space)	483mm
HR-QBP-1*		Anodized	1	32 dB	50 CFM	44mm (1 space)	264mm

*For half racks, such as HRF, see pg. 106



PDCOOL-1015RA



front



rear

PDCOOL-1115R

PowerCool Series, Power and Cooling

A single rackspace power distribution unit featuring ultra-quiet, powerful cooling, the PowerCool™ Series utilizes proportional speed blower control to run efficiently and save energy.

- 15, 20 Amps available
- 50 CFM free air rating
- Key switch model available for additional security



Power Solutions



100VAC



Part #	Description	# of Outlets	Amperage	Free Air Rating	Surge Protection	Racking Height	Max Sound Level	Finish
PDCOOL-1015RA	power distribution unit	10	15	50 CFM	Yes, two-stage	44mm (1 space)	29 dB	black brushed & anodized
PDCOOL-1020RK	power distribution unit with key switch	10	20	50 CFM	Yes, two-stage	44mm (1 space)	29 dB	flat black
PDCOOL-1115R	power distribution unit with front convenience outlet	11	15	50 CFM	Yes, two-stage	44mm (1 space)	29 dB	flat black
PDCOOL-1120R	power distribution unit with front convenience outlet	11	20	50 CFM	Yes, two-stage	44mm (1 space)	29 dB	flat black



FTA-3

FTA Series, Fan Tray System

Locates fans directly above hot equipment to help supplement rack cooling systems by moving hot air in the right direction.

- Uses 102mm DC fans for quiet operation
- 8 fan mounting positions and optional add-on fan to position fans where needed
- Energy-saving thermostatic control
- Adjustable mounting range of 457-813mm
- Compact one-space unit saves rackspace
- Ideal for use with VRS vented rackmount shelf, pg. 196

120V Part #	240V Part #	Description	Free Air Rating
FTA-3	IFTA-3	3 fan tray	207 CFM
FTA-6	IFTA-6	6 fan tray	414 CFM
FT-FAN	-	add-on 102mm DC fan	69 CFM

Power Solutions



100VAC – 2240VAC | 50/60Hz Compatible



TEMP-DEC

Decora® Mount Temperature Display

These displays monitor internal enclosure temperature, providing an LED readout.

- Includes plug-in power supply
- Includes temperature sensor w/ 1524mm cord to monitor desired location
- Mounts in any Decora® style opening
- Bright three digit, green LED display
- Adjustable overtemp setting with local and remote notification

Part #	Description
TEMP-DEC	temperature display
JDC-12X18	457mm, 12 volt DC jumper wire, 2 pieces
T1P	1 space rackmount panel pre-configured w/ 1 TEMP-DEC temperature display

Power Solutions



100VAC





Quiet-Cool Series™, Component, Cabinet and Closet Cooling

Middle Atlantic offers this unique set of products called Quiet-Cool Series™, which was designed to provide effective thermal management for several specific installation environments. Every product in this series employs smart thermostatic control to save energy and reduce unnecessary noise.

Component Cooler

- Lays on top of hot components to move air

Certifications

- CE

Power Solutions



100VAC – 2240VAC | 50/60Hz Compatible

120V Part #	240V Part #	Description	Free Air Rating	Max Sound Level
COMP-COOL	ICOMP-COOL	1 fan, power supply	8 CFM	19 dB
COMP-COOL-3*	ICOMP-COOL-3*	3 fans, connects to single power supply	8 CFM per fan	24 dB
COMP-COOL-E	ICOMP-COOL-E	1 fan, connects to COMP-COOL3	8 CFM	19 dB
COMP-COOL50	ICOMP-COOL50	system activates automatically when needed	50 CFM	29 dB
COMP-COOL50P	ICOMP-COOL50P	platform, system activates automatically when needed	50 CFM	29 dB

*914mm length between connectors



COMP-COOL50

Cabinet Cooler

- Mounts inside small cabinets, credenzas, or similar enclosures to move air

Certifications

- CE

Power Solutions



100VAC – 2240VAC | 50/60Hz Compatible

120V Part #	240V Part #	Description	Free Air Rating	Max Sound Level
CAB-COOL	ICAB-COOL	cabinet cool system	20 CFM	24 dB
CAB-COOL50	ICAB-COOL50	cabinet cool system	50 CFM	29 dB
CAB-COOL-2	ICAB-COOL-2	dual cabinet cool system	40 CFM	27 dB



CAB-COOL50

Closet Cooler

- For small systems in enclosed closes

Certifications

- CE

Power Solutions



100VAC – 2240VAC | 50/60Hz Compatible

120V Part #	240V Part #	Description	Free Air Rating	Max Sound Level
CLS-COOL1	ICLS-COOL1	active exhaust, passive intake	50 CFM	25 dB
CLS-COOL2	ICLS-COOL2	active exhaust, active intake	50 CFM	28 dB



CLS-COOL1

Duct Cool™ System

- Cools large enclosed areas
- ETL Listed

Power Solutions



100VAC

120V Part #	Free Air Rating	Duct Size	Free Air dB Rating**
DUCT-COOL-1PT	135 CFM	102mm	35.7 dB
DUCT-COOL-2PT	293 CFM	152mm	36.5 dB

**measured 1 meter from the air intake, centered horizontally & vertically, using 4572mm of straight insulated duct

Part #	Description	Fits	Part #	Description
ERK-DT-DT	Duct Cool™ Adapter	WMRK, ERK	THERM-A	optional user controlled thermostat with setpoint range of 60°F to 100°F
MW-DT	Duct Cool™ Adapter	DRK, WRK, MRK, VRK, VMRK		



DUCT-COOL-2PT application



Fans, Fan Kits and Accessories

Middle Atlantic offers a range of high quality fans and fan kits to let installers implement their selected thermal management strategy. Fan kits include fans, guards, and necessary vent blockers, and are designed for specific racks or usage locations such as for rear doors as noted. Some kit models also include intelligent thermostatic controls to save energy and minimize unnecessary noise.

- Fans are ball-bearing design for long life and quiet operation
- Fans include mounting hardware and cords
- Fan kits include fans, guards, and necessary vent blockers

Fans



Part #	Voltage	Size	Depth	Free Air dB Rating	Free Air Rating
FAN	120V	119mm	38mm	39 dBA	95 CFM
IFAN2-DC	240V	119mm	38mm	39 dBA	95 CFM
QFAN	120V	119mm	38mm	<30 dBA	50 CFM
FAN-6	120V	152mm	38mm	49 dBA	220 CFM
FAN-10	120V	254mm	89mm	49 dBA	550 CFM
BMF-FAN10	120V	254mm	108mm	60 dBA	825 CFM
FAN-119	240V	119mm	38mm	39 dBA	95 CFM
QFAN-119	240V	119mm	38mm	<30 dBA	50 CFM

Fan Kits

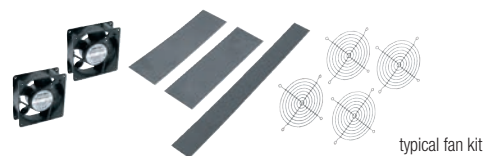

Part #	Application	# of Fans	Free Air Rating	Other Items Included
5-IFAN-K	top fits Slim 5 Series	2	114 CFM	hardware
DCFANKIT-4	rear panel, fits RK/BRK and RDR Series	4	100 CFM	120V adapter and controller
FAN2-DC	rear door	2	138 CFM	cord, and hardware, 120V
FAN2-DC-FC	rear door	2	138 CFM	hardware and controller, 120V
IMFR-FANKIT-2	rear panel, fits MFR Series	2	50 CFM	power supply, 240V
MFR-FANKIT-2	rear panel, fits MFR Series	2	50 CFM	power supply, 120V

Power Solutions



100VAC – 2240VAC | 50/60Hz Compatible

Power Solutions



100VAC – 2240VAC | 50/60Hz Compatible

Filter Panel



FILTER

Part #	Racking Height	Description
FILTER	133mm (3 spaces)	1" thick, washable fan filter panel

Fan Guards

Part #	Fits
GUARD	114mm fan
GUARD-6	6" fan
GUARD-10	254mm fan



GUARD-6

FP Series, Fan Panels

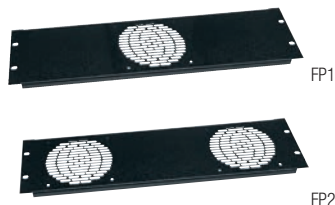

FP1

FP2

Black Anodized Part #	Black Textured Part #	Racking Height	Accommodates
FP1	TFP1	133mm (3 spaces)	one 114mm fan
FP2	TFP2	133mm (3 spaces)	two 114mm fans
FP3	TFP3	133mm (3 spaces)	three 114mm fans

Fan Cords

- Saves outlet space

Part #	Description
FANCORD-2X1	fan cord, accommodates two fans
FANCORD-3X1	fan cord, accommodates three fans
FANCORD-4X1	fan cord, accommodates four fans

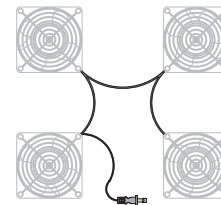

FANCORD-4X1

Power Solutions



100VAC

240V THERMAL MANAGEMENT OPTION



Fans: (2) IFAN2-DC
pg. 226



Fan Controller:
FC-DC pg. 130

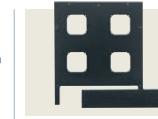

Top Options: ERK-4FT
or MW-4FT



KO Series Thermal Management Components for Rear Door

Middle Atlantic Products standard solid rear doors on WRK, MRK, and ERK Series enclosures are configurable to support the desired cooling strategy. Products in this section are designed to fit in these doors after the laser knockouts are removed.

Power Solutions



100VAC – 2240VAC | 50/60Hz Compatible



KO-AWFP2

Part #	Description	Fits
KO-AWFP2	fan kit with two fans, 190 CFM, 120V	WRK, MRK, ERK standard solid rear doors
IKO-AWFP2	fan kit with two fans, 190 CFM, 240V	WRK, MRK, ERK standard solid rear doors
KO-CRD-FAN	fan kit with two fans, 190 CFM and two vents	solid split rear doors
KO-CRD-VT	guard kit, 4 pc.	solid split rear doors
KO-FILTER3	filter kit	WRK, MRK, ERK standard solid rear doors
KO-VT3	vent panel kit	WRK, MRK, ERK standard solid rear doors
KO-WSB3	blank panel kit	WRK, MRK, ERK standard solid rear doors

VBK Series, Vent Blocker Kit

Vent blockers prevent the recirculation of hot air between top-mount fans and nearby vent openings to ensure the heated air will be forced out through the top mounted fans.

- Kits include the properly sized blockers for the intended model

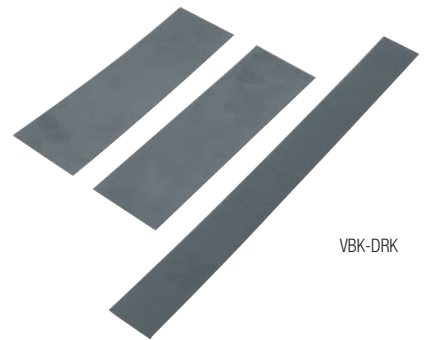

VBK-DRK

Part #	Fits	Part #	Fits	Part #	Fits
VBK-W27-W32	WRK-xx27 & WRK-xx-32	VBK-D17	DWR-xx-17	VBK-PTRK	PTRK-xx
VBK-WSA27	WRK-xxSA-27	VBK-SD22	SR-40-22, DWR-xx-22	VBK-PTRK26	PTRK-xx26
VBK-WSA32	WRK-xxSA-32, WR-xx-32*	VBK-S28	SR-xx-28	VBK-BGR	BGR Series
VBK-E20	ERK-xx20, DWR-xx-26	VBK-S32	SR-xx-32, DWR-xx-32	VBK-BGR-SA	BGR-SA Series
VBK-E25	ERK-xx25	VBK-S42	WR-xx-42*	VBK-DRK	DRK Series
VBK-E28	ERK-xx28	VBK-V	VRK-44-31H/VRK-44-36H		

*When WR is not flush against a wall, block the rear opening with the optional rear access panel, model # WR-RAP-xx

FC Series, Thermostatic AC Fan Control

These controllers extend both equipment and fan life and reduce service calls by varying the fan speed of up to four fans based on temperature.

- Control up to four fans, depending on model
- 3 user-selected temperature ranges
- Includes temperature sensor with 1524mm cord
- ETL Certified



FC-CFRD

Certifications

- CE

Power Solutions



100VAC – 2240VAC | 50/60Hz Compatible



FC-2-215-1CA

Part #	Description	# of Fan Controlled Outlets
FC-4A	mounts in MPR Series raceways only pg. 180	4
FC-4-1CA	mounts to rackrail brackets or any flat surface	4
FC-4-IEC	mounts to rackrail brackets or any flat surface, 240V	4
FC-2-215-1CA	mounts to rackrail brackets or any flat surface, includes two 15 Amp outlets	2
FC-CFRD	rackmount unit powers up to 16 fans in a fully populated system, designed specifically to control high CFM rear doors (CFRD Series) pg. 49	



High Definition Rackmount Consoles

High Definition LCD Rackmount Consoles are designed for the needs of the AV system, with a 100% digital platform that maintains complete digital signal integrity. This results in data that remains intact between source and display with no compatibility issues and no need for specialty cabling or accessories. Supporting a broad range of applications, rackmount consoles are ideal whenever rackmount control and system monitoring is required.

- High definition (1080p), widescreen (16:9)
- Designed for digital video, featuring an HDMI® certified 100% digital platform including HDMI/DVI inputs and HDCP compliance
- No special cables required – compatible with industry standard cables and extenders
- KVM model is IP-enabled for remote monitoring and management
- Models available in standard console configuration for single systems or console with 8 Port KVM for managing multiple systems from a single station
- Compact, 1-rackspace design includes 432mm widescreen display, keyboard & touchpad
- Dual rail design allows monitor to reside in open position for system monitoring while keyboard is recessed
- Fast one-person installation with quick-install rails
- Front USB port
- Supplied with U.S. style line cord



RM-KB-LCD17KVMHD

Certifications

- CE

Power Solutions



100VAC – 2240VAC | 50/60Hz Compatible



front



front



rear



rear

RM-KB-LCD17HD

RM-KB-LCD17KVMHD

Part #	Screen Size	Resolution	Racking Height	Inputs	Remote Console Outputs	IP-enabled
RM-KB-LCD17HD	432mm (16:9)	1080p (HD)	44mm (1 space)	VGA, DVI, HDMI, USB	VGA, DVI, HDMI, USB	–
RM-KB-LCD17KVMHD				HDMI (8), USB (8), DVI (6)	HDMI, USB (2)	yes



Lighting

Middle Atlantic offers a range of rackmount lighting and work lights to meet a variety of needs. Rackmount lighting is there when you need it; we offer styles for both back-of-the-rack and end-user front accessible lighting. And, we offer several styles of work light to meet installer and maintenance needs. Explore the offerings below to find the most appropriate model.

LT Series, Rackmount LED Work Light

- Complete flexibility to illuminate anywhere in the rack
- Vertical & horizontal mounting capabilities; adjustable angle light bar

Part #	Description	CE Approved
LT-CABUTL-SINGLE	cabinet utility light, single light, includes light bar with white leds, international power supply, cabinet attachment brackets	yes
LT-CABUTL-DUAL	cabinet utility light, dual light, includes light bars with white leds, international power supply, interconnect cable, cabinet attachment brackets	no



LT-CABUTL-SINGLE

Power Solutions



100VAC – 2240VAC | 50/60Hz Compatible

LT-GN Series, LED Gooseneck Light

- Portable lights can be powered by USB port or standard 120V outlet
- Rackmount panel version has two independently positionable lights
- Lights have off/on switch
- Long-lasting LED sources stay cool and bright

Part #	Description	Powered By
LT-GN	gooseneck LED light with USB connector	PDLT-815RVA, PD-915RV-RN, LT-1Rx or any computer w/ standard USB port
LT-GN-PL	gooseneck LED light with USB 120V adapter	Any 120V power outlet, including vertical power strips
LT-GN-PNL	one rackspace rackmount panel with dual gooseneck LED lights	
LT-GN-WL	magnetic worklight, gooseneck, includes 32 LED lights	



LT-GN

LT-GN-PNL

WL Series, Magnetic Work Light

- Powerful magnets keep lights in place and attach to any steel rack surface
- Cool, efficient fluorescent bulb
- UL Listed

Part #	Description	Powered By
WL-60	magnetic work light, jointed arm, v13W fluorescent bulb, long 18' cord	Any 120V power outlet, including vertical power strips



WL-60

Power Solutions



110VAC

PDLT Series, Rack Light and Power

- One-space design to save space
- 15 Amps; single circuit
- ETL Listed

Part #	Rear Outlets	Surge Protection	Cord Length	Chassis Depth	Finish
PDL-815RVA	8	Yes	2743mm	189mm	black brushed and anodized
PDL-815RV-RN	8	Yes, two-stage with remote notification	2743mm	189mm	black powder coat



PDL-815RV-RN



rear

Power Solutions



110VAC

LT-1R Series, Rackmount Light

Rackmount lighting features retractable LED light for evenly distributed illumination of the rackmounted components below.

- One-space design to save space
- Choice of black powder coat or black brushed and anodized finish

Part #	Cord Length	Chassis Depth	Finish
LT-1R	2743mm	189mm	black powder coat
LT-1RA	2743mm	189mm	black brushed and anodized



LT-1RA

Power Solutions



110VAC



Security Options

Middle Atlantic Products knows that many systems are installed in semi-accessible or accessible locations and so we offer a selection of security covers, doors and rackscrews to protect valuable equipment and critical connections. Models in this section include solid and vented covers as well as lockable solid and plexi doors to match the needs of the project.

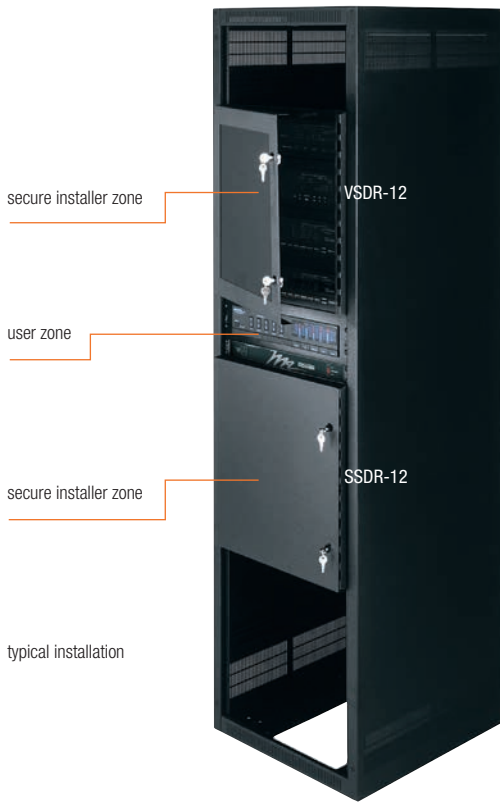

Security Doors

Hinged, keylocked security doors allow front access to a select portion of rackmount equipment. Mount equipment which needs to be secured behind these doors in the “installer zone” to keep unauthorized users from tampering. Keep equipment which needs to be client-accessed in the open portion of the rack in the “user zone.”

- Choice of plexiglass, vented, and solid styles
- Sturdy steel construction with black powder coat finish

Solid Part # Knob Clearance 35mm	Plexi Part # Knob Clearance 29mm	Vented Part # Knob Clearance 29mm	Racking Height
SSDR-8	PSDR-8	VSDR-8	356mm (8 rackspace)
SSDR-12	PSDR-12	VSDR-12	533mm (12 rackspace)
SSDR-15			667mm (15 rackspace)
SSDR-16	PSDR-16	VSDR-16	711mm (16 rackspace)
SSDR-20	PSDR-20	VSDR-20	889mm (20 rackspace)
SSDR-21			933mm (21 rackspace)



Hinged Security Covers

Cover specific equipment while allowing access with a key. Smoked plexiglass doors allow visibility to protected equipment.

- Steel frame with keylocked 3/406mm smoked-gray plexiglass door
- 38mm depth easily clears controls on most equipment
- Use with security screws for additional security (pg. 240)
- Available in 2, 3, 4, and 8 rackspace sizes

Part #	Racking Height
SECL-2	89mm (2 rackspace)
SECL-3	133mm (3 rackspace)
SECL-4	178mm (4 rackspace)
SECL-8	356mm (8 rackspace)



SECL-2



SECL-3



SECL-4

Fixed Security Covers

Fight equipment tampering with these tough fixed security covers. Secure and cost-effective.

- Choice of regular or fine metal perforation or fixed plexiglass window for easy equipment viewing
- 25mm depth clears controls on most equipment
- Use with security screws for additional security

Type	Part #	Racking Height
Regular Perf Allows unobstructed view of knob settings, 64% open area	S1	44mm (1 rackspace)
	S2	89mm (2 rackspace)
	S3	133mm (3 rackspace)
	S4	178mm (4 rackspace)
Fine Perf	SF1	44mm (1 rackspace)
	SF2	89mm (2 rackspace)
	SF3	133mm (3 rackspace)
	SF4	178mm (4 rackspace)
Plexiglass	SL-1	44mm (1 rackspace)
	SL-2	89mm (2 rackspace)
	SL-3	133mm (3 rackspace)



S1
regular perforated



SF1
fine perforated



SL-1
plexiglass



Blank Panels

Blank panels cover open areas on an installed rack face, providing a clean, professional appearance. Blank panels also serve an essential thermal management function by blocking unwanted airflow.

- Completes a finished, professional appearance
- Supports thermal management by preventing recirculation of hot air
- Sizes from 1/3 space up to 6 space panels
- Matching finishes are available



EB1-H



EB1/3



FEB1

Economy Blank Steel Panels

- 1/3 and 1/2 space panels ideal for non-fullspace components
- Panels in contractor packs are individually poly-bagged for protection

Flanged Part #	Flat Part #	Racking Height
EB1	FEB1	44mm (1 rackspace)
EB2	FEB2	89mm (2 rackspace)
EB3	FEB3	133mm (3 rackspace)
EB4	FEB4	178mm (4 rackspace)
EB5	FEB5	222mm (5 rackspace)
EB6	FEB6	267mm (6 rackspace)
EB1/2		22mm (1/2 rackspace)
EB1/3		15mm (1/3 rackspace)
EB1-H*		44mm (1 rackspace)

Contractor/Master Packs		
Flanged Part #	Flat Part #	Qty
EB1-CP12	FEB1-CP12	12
EB2-CP12	FEB2-CP12	12
EB3-CP6	FEB3-CP6	6
EB4-CP6	FEB4-CP6	6
EB1MP	FEB1MP	50
EB2MP	FEB2MP	25

*blank panel has handles for gripping pull-out rack systems

Flat Black Aluminum Blank Panels

- Choice of flanged or flat styles
- Sizes from 1 space up to 4 space panels
- Aluminum construction; can be machined if needed
- Panels in contractor packs are individually poly-bagged for protection



PBL-2



PHBL-3



PBL-1ID

Flanged Part #	Flat Part #	Racking Height
PBL-1	PHBL-1	44mm (1 rackspace)
PBL-2	PHBL-2	89mm (2 rackspace)
PBL-3	PHBL-3	133mm (3 rackspace)
PBL-4	PHBL-4	178mm (4 rackspace)
PBL-1ID*		44mm (1 rackspace)

Contractor/Master Packs		
Flanged Part #	Flat Part #	Qty
PBL1-CP12	PHBL1-CP12	12
PBL2-CP12	PHBL2-CP12	12
PBL3-CP6	PHBL3-CP6	6
PBL4-CP6	PHBL4-CP6	6

*comes with ID strip



Textured Blank Steel Panels

- Complements RSH4S custom rackshelves and other textured accessories
- Sturdy steel construction
- Sizes from 1 space up to 6 space panels
- Panels in contractor packs are individually poly-bagged for protection

Flanged Part #	Racking Height	Contractor/Master Packs	
		Flanged Part #	Qty
SB1	44mm (1 rackspace)	SB1-CP12	12
SB2	89mm (2 rackspace)	SB2-CP12	12
SB3	133mm (3 rackspace)	SB3-CP6	6
SB4	178mm (4 rackspace)	SB4-CP6	6
SB5	222mm (5 rackspace)		
SB6	267mm (6 rackspace)		

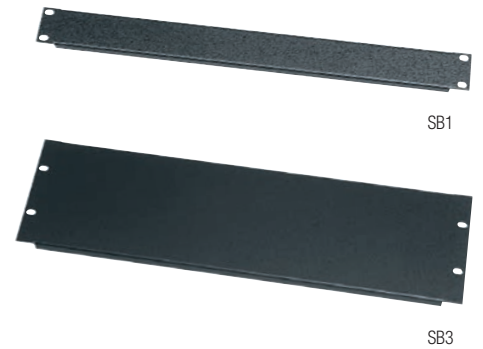

Black Brushed and Anodized Blank Panels

- The most aesthetic blank panels available with a black brushed and anodized finish
- Choice of flanged or flat styles
- Aluminum construction with premium anodized finish
- Sizes from 1/3 space up to 6 space panels
- 1/3 and 1/2 space panels ideal for non-fullspace components
- Complements RSH4A custom rackshelves and other anodized accessories

Flanged Part #	Flat Part #	Racking Height	Flanged Part #	Flat Part #	Racking Height
BL1	HBL1	44mm (1 rackspace)		HBL6	267mm (6 rackspace)
BL2	HBL2	89mm (2 rackspace)	BL1/2		22mm (1/2 rackspace)
BL3	HBL3	133mm (3 rackspace)	BL1/3		15mm (1/3 rackspace)
BL4	HBL4	178mm (4 rackspace)	BL1-H*		45mm (1 rackspace)
	HBL5	222mm (5 rackspace)			

*blank panel has handles for gripping pull-out rack systems

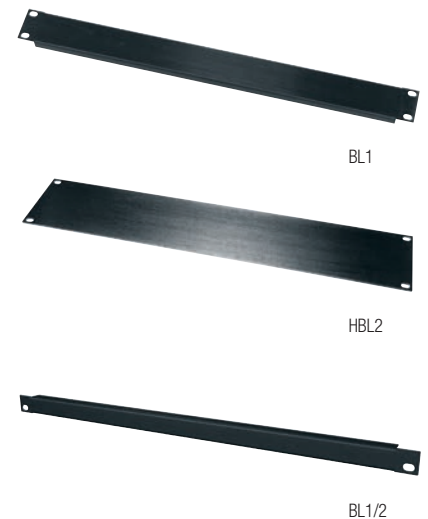

Wrinkled Blank Panels

- Sturdy steel construction with flanges for extra strength
- Sizes from 1 space up to 4 space panels

Flanged Part #	Racking Height
WSB1	44mm (1 rackspace)
WSB2	89mm (2 rackspace)
WSB3	133mm (3 rackspace)
WSB4	178mm (4 rackspace)





Vent Panels

Vent panels cover open areas on an installed rack face, providing a clean, professional appearance, while maintaining open area for cooling airflows. Middle Atlantic Products stocks many variations to meet every project need.

Note: venting is not always better – for more information on cooling strategies and practices, please see our white paper or contact our professional technical support department.

- Completes a finished, professional appearance
- Supports thermal management by allowing cooling airflows
- Sizes from 1 space up to 4 space panels
- Matching finishes are available

Flat Black Vent Panels

- Sturdy steel construction
- Sizes from 1 to 4 spaces
- VTB models manufactured with light blocking material
- Panels in contractor packs are individually poly-bagged for protection



EVT2



VT2



VTB-1



HR-EVT1

17% Open Area		Racking Height	64% Open Area		25% Open Area	Racking Height	64% Open Area		Racking Height
Flat Part #			Perf Part #	Perf Part #			Part #		
EVT1		44mm (1 rackspace)	VT1	VTF1	44mm (1 rackspace)		VTB-1	44mm (1 rackspace)	
EVT2		89mm (2 rackspace)	VT2	VTF2	89mm (2 rackspace)		VTB-2	89mm (2 rackspace)	
HR-EVT1*		44mm (1 rackspace)	VT3	VTF3	133mm (3 rackspace)		VTB-3	133mm (3 rackspace)	
HR-EVT2*		89mm (2 rackspace)	VT4	VTF4	178mm (4 rackspace)				

Contractor Packs		Contractor Packs		
Part #	Qty	Part #	Part #	Qty
EVT1-CP12	12	VT1-CP12	VTF1-CP12	12
EVT2-CP12	12	VT2-CP12	VTF2-CP12	12
		VT3-CP6	VTF3-CP6	6
		VT4-CP6	VTF4-CP6	6

*Designed specifically for the HRF Series, pg. 106



Black Brushed and Anodized Vented Panels

Brushed and anodized vent panels to match other anodized components and accessories are available from 1 to 3 rackspaces.

- Aluminum construction
- Black brushed and anodized finish

17% Open Area Anodized Part #	20% Open Area Part #	Racking Height
EVTA-1	VTP-1	44mm (1 rackspace)
EVTA-2	VTP-2	89mm (2 rackspace)
	VTP-3	133mm (3 rackspace)



EVTA-2



VTP-2

Hinged Accessory Mounting Panel

Provide quick access to rack interiors for servicing and maintenance.

- Available in solid, vented or with patented universal mounting pattern for small component mounting
- Tool-less captive, threaded thumbscrews will not get lost

Solid Part #	Universal Mounting Part #	Vented Part #	Racking Height
AP-2	APM-2	APV-2	89mm (2 rackspace)
	APM-3		133mm (3 rackspace)
AP-4	APM-4	APV-4	178mm (4 rackspace)
AP-6		APV-6	267mm (6 rackspace)



APM-3



AP-4



Connector Panels

Middle Atlantic Products offers a wide selection of utility and special-purpose chassis and connector panels to support your project needs. As is the case with our other products, each of these models was designed with speed and effectiveness in mind to provide installers with excellent installation results, and work with all our rack systems.



UNI-1

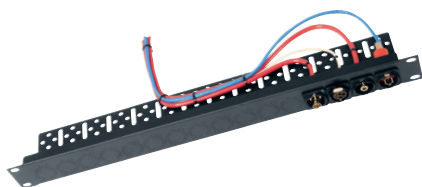

UNI-1-C

Universal Connector Panel

The UNI Series laser-cut connector panels feature knockouts designed to accept a number of connectors, including XLR and Neutrik.

- Design allows mounting of both male and female connectors to the same holes simply by knocking out the correct pattern
- Incorporates a 67mm strain relief shelf with tie-points for cable management (UNI-1)

Part #	Laser-Cut Knockouts	Racking Height
UNI-1	16	44mm (1 rackspace)
UNI-2	32	89mm (2 rackspace)
UNI-1-C	16	44mm (1 space) - includes cable management



More AVIP plates from Wiremold® at middleatlantic.com

AVIP Rackmount Panel System

This great solution provides rackmount connectivity without the wait or expense of custom panels.

- Holds industry-standard modular AV connector plates including Wiremold® AVIP, Extron® MAAP, and FSR IPS
- Works with single, double, and triple size plates
- Fixed and easy-access hinged styles are available for standard racks
- Fixed styles are also available for half-rack applications

Fixed Part #	Swing Out Part #	Description
AVIP-FK1	AVIP-SF1	1 space, 483mm width
AVIP-FK2	AVIP-SF2	2 space, 483mm width
AVIP-HFK1		1 space, 254mm width



AVIP-FK1



AVIP-FK2



shown with plates installed



UCP Series, Modular Panel System

Build Your Own Custom Connector Panel Using Off-The-Shelf Components! Middle Atlantic Products UCP Series modular custom panel system assembles quickly and easily using either a 2 or 4 space frame kit and your selections from an extensive collection of prepunched modules.

- Modules accept popular connectors such as XLR, Neutrik, Elco, Canare and more
- UCP modular assemblies simply bolt together using supplied hardware
- When completed, all hardware is flush to create a professional appearance
- Visible parts have a black brushed and anodized finish
- Blank and vented panels are also available to fill unused spots
- All modules are constructed of aluminum

UCP Series Frame Kit

- Bolts modules to them in any combination

Frame Kits Part #	Racking Height
FK2	44mm (1 rackspace)
FK4	89mm (2 rackspace)

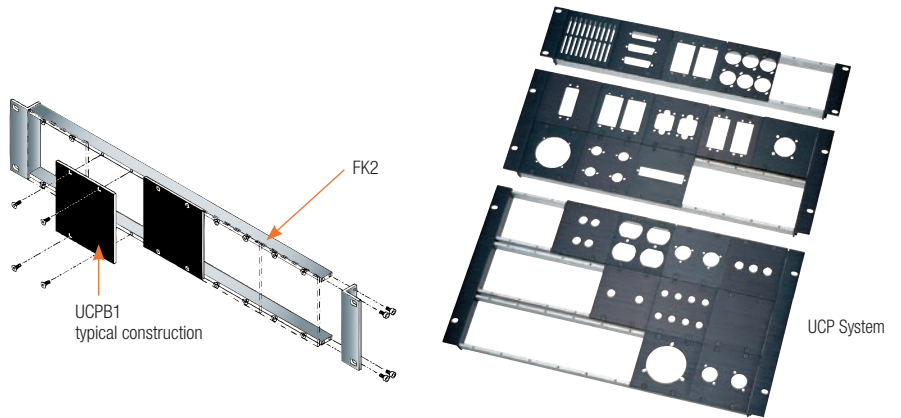

UCP Series Chassis

The 2 space UCP chassis holds five modules in the front, and five modules in the rear. Shipped fully-assembled, each unit is comprised of four threaded FK bars, a pair of ears 229mm deep, top and bottom, and all necessary module mounting hardware. The top & bottom can be easily removed, leaving the frame intact.



UCP Series Cable Tray, 2 Space

The UCP cable tray includes FK2 bars, mounting ears and bottom. 127mm deep tray provides superior cable strain relief with a multitude of wire-tie slots. Occupies 2 rackspaces (89mm).

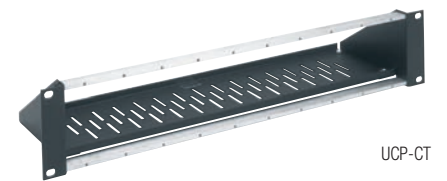

UCP Series Hinged Frame Kit, 2 Space

This hinged version of the FK2 frame kit allows rear access to modules. Captive 10-32 threaded thumbscrews hold the frame closed and require no tools to open. Kit includes a pair of threaded FK bars, hinged ear, captive thumbscrew ear, and all module mounting hardware.





UCP Series, Modular Panel System

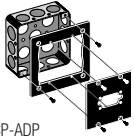

UCP-ADP
UCP Adapter,
1900 Electrical Box
Adapts any single UCP module to a standard 1900 electrical box



UCPB1
UCP Blank Module,
Single Width
Fills unused spots or drill your own connector mounting pattern



UCPB2
UCP Blank Module,
Double Width
Fills unused spots or drill your own connector mounting pattern



UCPB3
UCP Blank Module,
Triple Width
Fills unused spots or drill your own connector mounting pattern



UCP-FAN
15 CFM Fan, Mounts to UCP Frame Kit
Fan rated to move 15 CFM at 25 dBA

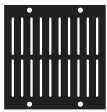

UCP-VT
UCP Vent
Fills unused space while providing ventilation



1/2BNC1
UCP Module, One 13mm BNC Punchout
Fits 13mm diameter BNC shells



1/2BNC2
UCP Module, Two 13mm BNC Punchouts
Fits 13mm diameter BNC shells



1/2BNC4
UCP Module, Four 13mm BNC Punchouts
Fits 13mm diameter BNC shells



1/2BNC5
UCP Module, Five 13mm BNC Punchouts
Fits 13mm insulated BNC connectors for RGBHV

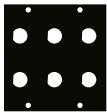

1/2BNC6
UCP Module, Six 13mm BNC Punchouts
Fits 13mm diameter BNC shells



1/4X4
UCP Module, Four 1/4" Punchouts
Fits RCA jacks, some switches and LEDs



1DB25
UCP Module, One DB25 Punchout
Fits the popular data multipin connector



1DB9
UCP Module, One DB9 Punchout
Fits the popular data multipin connector



1ELC090
UCP Module, EDAC/ELCO 90 Pin Punchout
Fits 90 pin Elco/Edac connectors



1G1
UCP Module, G1 Punchout
Fits "G" Series AMP connectors



1W1
UCP Module, 39 pin Whirlwind Punchout
Fits 39 pin Whirlwind



1W2
UCP Module, 61 pin Whirlwind Punchout
Fits 61 pin Whirlwind



2DB15
UCP Module, Two DB15 Punchouts
Fits the popular data multipin connector



2DB25
UCP Module, Two DB25 Punchouts
Fits the popular data multipin connector



2DB37
UCP Module, Two DB37 Punchouts
Fits the popular data multipin connector



2DB50
UCP Module, Two DB50 Punchouts
Fits the popular data multipin connector



2DB9
UCP Module, Two DB9 Punchouts
Fits the popular data multipin connector

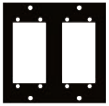

2ELCO90

UCP Module, Two EDAC/ELCO 90 Pin Punchouts
Fits 90 pin Elco/Edac connectors



3/8BNC4

UCP Module, Four 10mm BNC Punchouts
Fits 10mm diameter BNC shells



3/8X1

UCP Module, One 10mm Punchout
Fits attenuators, "F" connectors, phone jacks, some switches



4DB9

UCP Module, Four DB9 Punchouts
Fits the popular data multipin connector



4SC1

UCP Module, One Circular Flange Punchout
Fits Cannon AP and EP, Neutrik, NL8MPR, NL4MPR ("Speakon")



4SC3

UCP Module, Three Circular Flange Punchouts
Fits Cannon AP and EP, Neutrik, NL8MPR, NL4MPR ("Speakon")



7/16X4

UCP Module, Four 11mm Punchouts
Fits Switchcraft #11, insulated phone jacks, and some switches



AVIP-UCP

UCP Module, One AVIP Punchout
Accepts 3 single, 1 dual, or 1 triple connector plates



CANARE4

UCP Module, Four Canare Punchouts
Fits regular and feed-through types



COMBO4

UCP Module, Four Mixed Gender XLR Punchouts
Fits mixed genders within a module

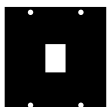

KEY-1

UCP Module, One Keystone Punchout
Holds varied connectors (RCA, RJ-45, Fiber, etc.) in keystone insert bezel



KEY-2

UCP Module, Two Keystone Punchouts
Holds varied connectors (RCA, RJ-45, Fiber, etc.) in keystone insert bezel

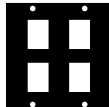

KEY-4

UCP Module, Four Keystone Punchouts
Holds varied connectors (RCA, RJ-45, Fiber, etc.) in keystone insert bezel

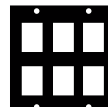

KEY-6

UCP Module, Six Keystone Punchouts
Holds varied connectors (RCA, RJ-45, Fiber, etc.) in keystone insert bezel



SPX-19

UCP Module, Socapex 19 Pin Punchout
Fits Socapex 19 pin connector



TW2B

UCP Module, 2 Bolt Twistlock Punchout
Fits most brands with oval hole pattern, including Hubbel Bryant



TW3B

UCP Module, 3 Bolt Twistlock Punchout
Fits most brands with oval hole pattern, including Hubbel Bryant



UNIV1

UCP Module, One XLR Female Punchout
Fits Neutrik FP, MP, MDL, FDL, Speakon, XLRs, and more



UNIV2

UCP Module, Two XLR Female Punchouts
Fits Neutrik FP, MP, MDL, FDL, Speakon, XLRs, and more



UNIV3

UCP Module, Three XLR Female Punchouts
Fits Neutrik FP, MP, MDL, FDL, Speakon, XLRs, and more

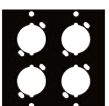

UNIV4

UCP Module, Four XLR Female Punchouts
Fits Neutrik FP, MP, MDL, FDL, Speakon, XLRs, and more



UNIV6

UCP Module, Six XLR Female Punchouts
Fits Neutrik FP, MP, MDL, FDL, Speakon, XLRs, and more



XLRM6

UCP Module, XLR Male Punchouts
Fits Neutrik MP, LNEMP, Switchcraft, Cannon



Hardware and Fasteners

Don't forget the rack screws! Professional installers know that sometimes the smallest products and details can make the difference in appearance, function, and speed. Don't let an inferior screw mar your installation – insist on Middle Atlantic hardware.

Rack Screws, Security Screws and Fasteners











- Choice of head designs and finishes (rust-resistant finish is available)
- Most models are 19mm long with pre-installed washers and self-guiding pilot points
- Cable-friendly screws are 10mm long with rounded tip to resist chafing
- Security screws, including the patented high security Guardian Series™, provide additional equipment protection

Shoulder Washers,
100 Pieces



Works with pre-installed washers
on our screws to isolate equipment

SW

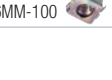
	Series	Type	# of Pieces	Head Type	Length	Finish	Factory Installed Washer	Self Guiding Pilot Points	Security Accommodations	Compatible Bit	Recommended & Primary Use(s)
 HG	HG	10-32 threaded	100 500 (HG500)	truss-head	19mm	black gloss, salt spray resistant	yes	yes	no	no	premium rack screws provide best bit engagement in the industry
 HM	HM	10-32 threaded	100 500 (HM500)	truss-head	19mm	black matte	yes	yes	no	no	premium rack screws provide best bit engagement in the industry
 HP	HP	10-32 threaded	100 500 (HP500)	truss-head	19mm	black matte	yes	no	no	no	for standard rackmounting applications; fits under optional trim strips
 HW	HW	10-32 threaded	100 (HW100) 500 (HW500)	trim-head	19mm	black matte	yes	no	no	no	for standard rackmounting applications
 HSK	HSK	10-32 threaded	100	square post drive	19mm	black matte	yes	no	Guardian Series™ patented security hardware	optional SBIT	highest level of security
 HTX	HTX	10-32 threaded	50	star post drive	19mm	black matte	yes	no	requires star post bit	optional TBIT	security
 HS	HS	10-32 threaded	100	square drive	19mm	black matte	yes	no	requires square bit	optional SBIT	security
 HPQ	HPQ	10-32 threaded	100 500 (HPQ-500)	truss-head	10mm	black matte	no	rounded end allow wires to be dressed inside rack without chafing	no	no	ideal for mounting vent panels and cable management bars
 HP-24	HP-24	12-24 threaded	100 500 (HP24-500)	heat treated to prevent head stripping	16mm	black matte	washers included	no	no	no	telecommunications and data
 HP-6MM	HP-6MM	6mm threaded Phillips head	100	heat treated to prevent head stripping	16mm	black matte	washers included	no	no	no	telecommunications and data
 CN1032-50	CN1032-50	cage nut hardware, for use with 10-32 rackscrews	50	cage nut hardware	n/a		n/a	n/a	no	no	slide out servers with square hole rail
 CN6MM-100	CN6MM-100	cage nut hardware, for use with 6mm rackscrews	100	cage nut hardware	n/a		n/a	n/a	no	no	slide out servers with square hole rail



Trim Strips

As a final aesthetic complement to any installation, add our finishing trim strips.

- A quick, clean and effective method of covering rack screws once the job is complete
- Each channel-shaped trim strip measures 45 spaces (2000mm long)
- Features internal grooves that fit into the supplied snap washers
- Offered in black brushed and anodized or black powder coat finish
- Cut easily to size with a hacksaw
- Sold in individual strips.



without trim strip installed



without trim strip installed

Part #	Finish	Includes
TA	black brushed & anodized	mounting screws (16), snap washers (16), end caps (8)
TS	black powder coat	mounting screws (16), snap washers (16), end caps (8)

Panels for Decora® Devices

Mount any low-voltage Decora device directly onto rackrail of standard 483mm enclosure. Great mounting solution for RPS Series remote power switches (pg. 186) and TEMP-DEC temperature displays (pg. 224).

- Panels take up only one rackspace
- Available models hold from one to four devices
- Flanged steel construction with durable black powder coat finish

Part #	Description
DECP-1X1	44mm (1 space) mounts up to 1 Decora device
DECP-1X2	44mm (1 space) mounts up to 2 Decora devices
DECP-1X3	44mm (1 space) mounts up to 3 Decora devices
DECP-1X4	44mm (1 space) mounts up to 4 Decora devices



DECP-1X1



DECP-1X3



Other Hardware

This section includes useful hardware that solves specific installation challenges, including such varied items as rail bracket adapters to touch-up paint. Browse the products in this section – you might find a solution you have been hoping for.

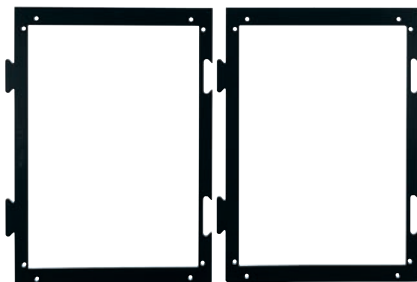

BGR-TEMP-27

Multi-Bay Floor Layout Template

- Template allows accurate installation planning and mounting
- Ideal for pre-drilling floor anchor bolts, etc.
- Designed for accurate single and multi-bay layouts

Multi-Bay Floor Layout Template	Accommodates
BGR-TEMP-27	BGR 686mm depth racks
BGR-TEMP-32	BGR 813mm depth racks
BGR-TEMP-38	BGR 965mm depth racks
MRK-TEMP-26	MRK 660mm depth racks
MRK-TEMP-31	MRK 787mm depth racks
MRK-TEMP-36	MRK 914mm depth racks
WRK-TEMP-27	WRK 686mm depth racks
WRK-TEMP-32	WRK 813mm depth racks



BOND-G24

Spike, Rack Bonding Kits

Combines ganging and electrical bonding in one step by piercing powder coat finish at bonding points without removing paint.

- Eliminates bonding wires between racks
- Provides low impedance ground
- Displaces powder coat finish without corrosion protection of painted surface
- Does not require anti-oxidant protection
- Durable and visible green finish

Part #	Description
BOND-G24	24 sets, 1 installation tool, 4 sets recommended per rack



ACC-KEY

Keys

Part #	Description
ACC-KEY	additional set of keys for drawers and LBX
SFD-KEY	key for front door
SRD-KEY	key for rear door



DOC

Document Holder

Part #	Description	Fits
DOC	document holder for rear door	fits on most rear doors
DOC-SACK	document holder for rear door	compatible with BGR enclosures



RRF Rackrail

All-steel RRF rackrail is threaded for 10-32 screws and is finished in a durable black e-coat finish. With EIA standard spacing, they are sold in pairs and designed for use with 486mm wide rough openings.

- Sturdy 3mm thick steel construction



Part #	Racking Height
RRF2	89mm (2 space)
RRF4	178mm (4 space)
RRF6	267mm (6 space)
RRF8	356mm (8 space)
RRF10	445mm (10 space)
RRF12	533mm (12 space)
RRF14	622mm (14 space)
RRF16	711mm (16 space)
RRF18	800mm (18 space)
RRF21	933mm (21 space)
RRF27	1200mm (27 space)
RRF45	2000mm (45 space)

Drift Pins for Ganging

- Easily align racks while ganging*

Part #	Description
DRIFT	set of two tapered drift pins
TDRIFT	ganging drift pins, non-tapered

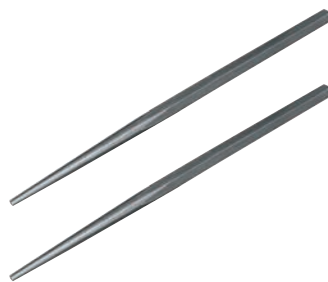

*not compliant with BGR

DRIFT

Ganging Hardware

- Kit of 8mm flange nuts and bolts to gang up to 10 racks

Part #	Description
GANG-10	8mm nuts/bolts to gang 10 racks or consoles
GANG-10T	8mm bolts for ganging BGR and SNE via threaded inserts

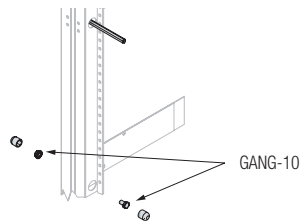

Ganging Hardware

- Makes ganging racks easier, comes as a set of two 13mm magnetic sockets

Part #
MAG-1/2

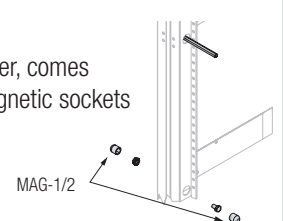



Touch-Up Paint

- 0.6 fluid oz. of paint and applicator for minor finish touch-ups

Part #
WRINKLE

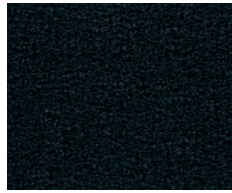

WRINKLE

Rack Electrical Isolation Knockout Panel

- Replaces standard rear electrical knockout plates to isolate connections from rack

Part #	Fits
ISO-KOP	MRK, WRK, DRK, ERK

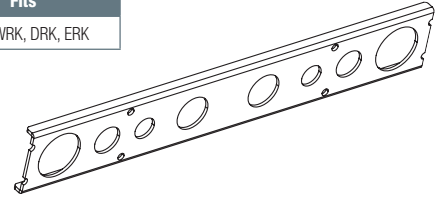

ISO-KOP

Micro Fiber Cloth, Anodized Panels

- Reuseable, non-abrasive and lint free cloths to keep installations clean

Part #
PNL-CLN



PNL-CLN

Rack Ground Isolation Kit

- Isolate the rack from conductive flooring materials
- Consists of eight 102mm long strips of 3mm thick non-conductive polycarbonate

Part #
ISO-1

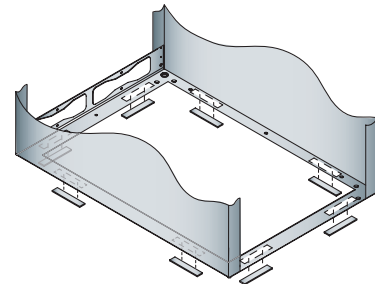

ISO-1

2 Space Rackrail Recessor, 76mm Depth

- Enables installer to recess equipment 76mm behind rackrail
- Comes as a pair

Part #
RR2-3RCN

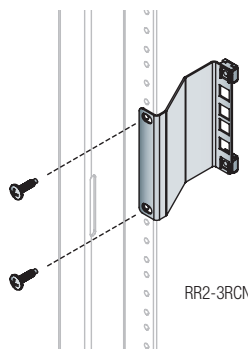

RR2-3RCN



Rear Hanging Brackets

- Additional support for equipment with rear mounting ears

Part #	Racking Height
RH2	89mm (2 rackspace)
RH3	133mm (3 rackspace)
RH4	178mm (4 rackspace)



RH-2

Rack Sack™ Equipment Cover

- Rack Sack™ protects an installation in progress from dust and contact

Part #	Dimensions
RS-6036	1524mm h x 508mm w x 914mm d
RS-8436	2134mm h x 635mm w x 914mm d



RS-6036

Shim Tabs, 100 Pieces

- 2mm thick shims can be used to make faceplates flush

Part #	Racking Height
ST1MP	44mm (1 rackspace)
ST3MP	133mm (3 rackspace)

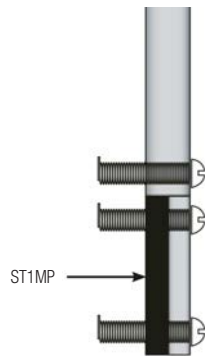

Rackspace Ruler

- 4877mm tape measure with traditional measurement, rackspace markings and audio/data formulas

Part #
RULER



RULER

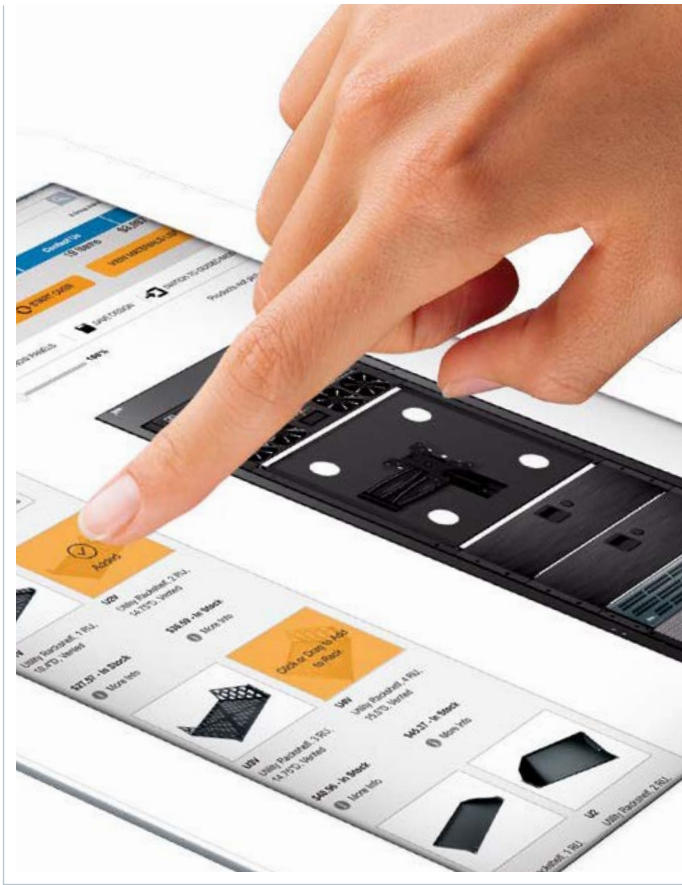

imagine. design. build.
browse. shop. design



New web-based configuration tool provides a simple and personalized experience to design great systems. Available 24/7 on middleatlantic.com, this new platform allows users to quickly and efficiently select the right products and accessories for any system.

- Create a personalized configured solution with a priced materials list
- Export CAD and other design documents
- Built-in intelligence only recommends products & components that fit the chosen host enclosure
- 24/7 access
- Visit middleatlantic.com to get started



See It In Action





Shop Online

Check out Middle Atlantic Products' latest innovations middleatlantic.com

- Compare products
- See what's new





Middle Atlantic Designer™

Free 3D layout software for creating full consoles, video walls and room layouts.

- Quickly and easily create full system designs in 3D
- Includes commonly used room elements; including doors and windows
- Creates Retail quotes
- Delivers design specifications
- Features include:
 - Line-of-site tool
 - Note tool
 - Exports to AutoCAD in 2D and 3D
 - Automatic software updates & Full color design
- Only works on PC

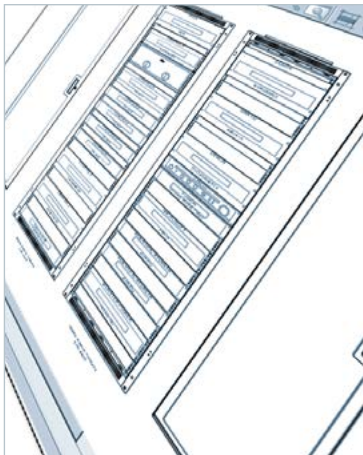

RackTools®

Middle Atlantic Products is pleased to announce the release of RackTools® 3.5. We've updated RackTools® to make creating a system layout even faster and easier than before. Through improved navigation, smaller files sizes and faster running, this is the easiest way to lay out an enclosure system.

RackTools® software increases the efficiency of your business by allowing engineers and salespeople to quickly and easily specify Middle Atlantic Products, and create accurate rack elevation, plan, side and rear view drawings, purchase orders, and quotes in minutes.



HPL Options | HUB, C5 & L5 (L5 - Sota style only)

wood grain						solid finish						
							visual texture					

t-mold edge HUB option only												

Veneer Options | C5 & L5

wood grain										
------------	--	--	--	--	--	--	--	--	--	--

Thermolaminate Options | C5, L5 & TechPed™

t-lam										

Semi-Custom Colors

steel				

Fused Acrylic Melamine Options | MFR & RFR

MFR			



1/2BNCx	238	CFR-x	109	DRIFT	243	HCT-x	212
1DBx	238	CHx	201	D-RING	211	HDR-x	73
1Wx	238	CHAIR-x	145	DRK19-x	27	HDR-FAN	73
2-x	104	CK-x	215	DT8x	149	HGx	240
2-6M	105	CLAWx	219	DT-PVFD-x	111	HHCM-x	212
2DBx	238	CLB-x	218	DT-RAPx	111	HMx	240
2ELCO90	239	CLB-CSBx	218	DTRK-x	111	HPx	240
3/8BNC4	239	CLB-TSBx	218	DT-VFD-x	111	HPM-x	77
3/8X1	239	CLB-Vlx	218	DUCT-COOL-x	225	HPM-LID	77
4DB9	239	CLB-VOx	218	DVDx	198	HPQx	240
4SCx	239	CL-GK	218	DVFD-44	27	HRBLx	107
5-x	28	CLH-x	218	DVRD-44	27	HR-EVTx	107
5ARx	29	CLH-ADJH	218	DWR-x	61	HRF-x	107
5-BAVTRIM	29	CLH-ADJT	218	DWR-CVR	61	HR-QBP-1	107
5CCx	29	CLH-ARx	218	DWR-FKx	61	HR-UMS1-x	107
5-RSx	109	CLH-ARDx	218	DWR-RRx	61	HS	240
5W	44	CLH-EC-x	218	DWRSR-ZL	61	HSK	240
5WL	44	CLH-EDx	218	EBx	232	HTX	240
5WLR	44	CLH-ELS-x	218	EC-x	201	HUB	140
5WR	44	CLH-HTSx	218	EL-x	149	HWx	240
ACC-KEY	242	CLH-JBOLT	218	ELUR+x	149	IDF-ARB-24	111
ANGLE-x	55	CLH-RESx	218	ELUR-x	149	IDF-TM-x	111
AP-x	235	CLH-RSJx	218	ERK-x	43	IEC-x	185
APM-x	235	CLH-RWCx	218	ERK-x-CONFIG	54	ISO-1	244
APV-x	235	CLH-SDx	218	ERK-DT	47	ISOCTR-5R-x	183
AS3-22	192	CLH-SPOOL-10	218	ERK-LVT	43	ISO-KOP	244
ASR-x	90	CLH-SS-12-2	218	ERK-ST	46	ISRK-12GY	105
AVIP-x	236	CLH-WRSx	218	ERK-VRD-x	43	J-x	181
AXS-x	84	CLS-COOLx	225	ERK-VT	43	JMS-12X6	181
AXS-FAN-x	85	CLVRD-WMRK-x	23	ES+x	149	KB-SS	199
AXS-GGx	85	CMB-6	219	ES-x	149	KDBx	195
AXS-TEXTTRIM	85	CM-x	149	ESUR+x	149	KDEx	195
AXS-WTx	85	CN1032-50	240	ESUR-x	149	K-DEC	187
AX-SX-x	85	CN6MM-100	240	ESX-ACC-BKT	131	KEY-x	239
AX-SXR-x	87	COMBO4	239	EVFD-x	63	KO-AWFP2	227
BANGLE-x	53	COMP-COOLx	225	EVTx	234	KO-CRD-FAN	227
BB-x	187	CRD-WMRK-x	23	EVTA-x	234	KO-CRD-VT	227
BFD-x	13, 33	CSA-x	201	EWR-x	63	KO-FILTER3	227
BG17	85	CSB	119	EWR-ARB-x	63	KO-VT3	227
BGR-x	13, 33	CWR-x	65	FANx	226	KO-WSB3	227
BGR-CC-x	13, 33	CWR-FKIT	65	FAN2-x	226	KYLK	203
BGR-ISOx	13, 33	CWR-OFRRx	65	FAN-x	226	L5-x	136
BGR-LVT9	13, 33	CWR-RRx	65	FANCORD-x	226	LACEx	214
BGR-RDCx	13, 33	D12-x	149	FANPNL-2DC	130	LACEx-xPK	130
BGR-RRx	13, 33	Dx	202	FANTOP-138DC	130	LATCH	203
BGR-STPx	13, 33	D2-UMS-28	202	FBPANEL-x	131	LB-xA-x	130
BGR-TEMP-x	242	DANGLE-x	53	FC-x	227	LBFR-x	211
BGR-TRIMx	13, 33	DCDP	203	FC-CFRD	227	LBH-1930-T	211
BGR-TRRx	13, 33	DCFANKIT-4	226	FC-DC	130	LBP-x	210
BGR-Z4	13, 33	DCFRD-x	43	FD-x	48	LBP-LTF	210
BLx	233	D-CFRD-44	43	FD-WMRK-x	23	LBX-x	203
BMF-FAN10	226	DCLVRD-44	27	FEBx	232	LD-x	150
BOND-G24	242	D-CPU	151	FI-x	203	LFx	45
BPFD-x	13, 33	DCRD-44	49	FILTER	226	LL-DTRK	111
BRx	213	DECP-x	241	FIN-x	249	LL-Hx	206
BRKx	98	DFVRD-44	27	FKx	237	LL-MP21	206
BS-BGR	13, 33	DLBX-x	77	FPx	226	LL-RFR	97
BS-MRK-x	44	DLVFD-44	27	FTA-x	224	LL-SNE-x	15
BSPN-x	13	DLVRD-44	27	FT-FAN	224	LL-VAx	206
BS-WRK-x	44	DM	203	FVS-x	157	LL-VCx	206
BUNDLE-x	129	DO-x	29	FWS	199	LL-VDINx	206
BVFD-x	13, 33	DOC	242	G-8X10	181	LL-VPx	206
C5x	134	DOC-SACK	242	GANG-x	243	LL-VTC-K	155
CAB-COOLx	225	DOOR-x	123, 125	GK-x	219	LT-x	229
CANARE4	239	DOP-x	29	GR-30	219	LT-GNx	229
CAPx	195	DPFD-44	27	GUARDx	226	LVFD-x	48
CBS-x	46	D-PTx	151	HANG-MMRx	125	LVFD-WMRK-x	23
CC-x	216	DPVFD-44	27	HBLx	233	M-15x	180
CDx	198	DR-x	103	HCM-x	211	M-20x	180



M-2xx	180	PROWMRK-RRx	23	SFD-KEY	242	UPS-IPCARD	166-167
M-30TL-HWA	180	PROWMRK-ZRA-x	50	SFR-x	71	UPS-RBP	166
MAG-1/2	243	PROWRK-RRx	25	SH-BRKx	99	UPS-SxR	167
MBRKx	98	PSDR-x	230	SH-DMP-x	198	UQFP-x	222
MD-KB	153	PTRK-x	104	S-IEC-x	185	USC-6R	187
MDV-x	153	PVFD-44	48	SL-x	231	USC-K	187
MFR-x	97	PWR-x-V	128	SNEx	15	USC-KEY	187
MK-x	116	PWR-9-RP	128	SNE-CC-x	15	USC-KL	187
MK-LA	218	PWR-9-RPM	128	SNE-IVCMF-x	15	USC-SW	187
MMB-x	144	QAR-x	122	SNE-TCB-x	15	USC-SWL	187
MMR-x	124	QBP-2x	223	SPM-x	73	UTR1x	197
MPR-x	180-181	QFANx	226	SPX-19	239	VBK-x	227
MPR-BLx	181	QFP-x	223	SR-x	59	VCD-x-x-SC	215
MPR-JBx	181	QTFP-x	223	SRB-x	51	VDS	192
MPR-SEQA	180	R2-44S	119	SRCC	93	VFD-x	48
MPR-SS	181	R412-xB	115	SRD-KEY	242	VFEEt-x-x	53
MRK-x	16	R412-RRx	115	SRK	101	VLBx	77
MRK-xAXS	85	R4CN-xB	115	SRSx-x	93	VMRK-x	21
MRK-x-AV	55	RAPx	29	SRSR-x-x	93	VPANEL-x-2PK	131
MRK-TEMP-x	50	RBA-x44-2	50	SR-SUB	59	VPM-x	75
MS-x	197	RC-x	195	SR-UPS-BKT	59	VRK-x	19
MV-PVTx	47	RCS-x	126	SS	192	VRS	196
MV-RRx	17, 19	REBx	90	SSx-xVTR	193	VSA-x	193
MV-ZRA-44	50	RFR-x	96	SSAX-x	83	VSDR-x	230
MW-xFT	46	RFR-CABCOOL50	97	SSDR-x	230	VTx	234
MW-xFT-x	46	RFR-ERRK-x	97	SSHD-28	192	VTx-CP12	234
MWCFRD-1/2PNL-x	49	RH-x	245	SSL	192	VTB-x	234
MW-CFRD-x	49	RIB-x	53	SS-VTR-CVRx	193	VTC-x	155
MW-CLVRD-x	49	RKx	98	SSx-xVTR	193	VTC-DWR-x	155
MW-CRD-x	49	RKDRAWER-xU-LK	131	STxMP	245	VTC-R1214	155
MW-DT	47	RK-GDx	99	SW	240	VTC-SPK-SHx	155
MW-LA	47	RK-RAP1x	99	SWR-x	67	VTC-WS-32X12SL	155
MW-LVRD-x	49	RK-RRx	99	T1P	224	VTFx	234
MW-LVT	46	RKSHELF-x-2PK	131	T-xX6	181	VTFx-CP12	234
MW-ST	46	RKWx	99	TA	241	VTP-x	235
MW-TR	47	RL10-x	119	TDx	202	WANGLE-x	53
MW-VRD-44	49	RL12-x	119	TDRIFT	45, 243	WL-60	229
MW-VT	46	RLA19-x	119	TEMP-DEC	224	WM-x	71
OBRKx	98	RLA-CC	215	TFPx	226	WMANGLE-x	53
OCAP-x	196	RLM-x	180	THERM-A	225	WMRK-x	23
OSRx	100	RLM30-x	180	TOR-x	69	WMRK-xSVR	55
PB-x	187	RLM-30TL-HWIGA	180	TOR-PRT	69	WMRK-xSVR-AB	55
PB-DWR	187	RLNK-MONx-NS	168	TP-Fx	139	WMS-1614x	200
PBL-x	232	RLNK-SWx-NS	168	TP-Kx	139	WMS-20	200
PBS-WMRK-x	23	RLNK-SWxR-SP	168	TP-MK1	139	WR-x	81
PB-XS	187	RLNK-SWxR	168	TRACKx	83, 85	WRFD-x	81
PCD-x	216	RM-KB	199	TS	241	WRINKLE	244
PCDB-90-1.5-12	216	RM-KB-LCDx	228	TS310	83	WRK-x	25
PCR-x	179	RM-LCD-x	200	TSW-15	219	WRK-24MDK	39
PD-x	170-171, 172, 174-175, 178	RPS	186	TW12	219	WRK-xSA-x	37
PDC-x	169	RPS-K	186	TWxB	239	WRK-x-xAXS	85
PDCOOL-x	224	RPS-KEY	186	Ux	194	WRK-RRx	25
PD-HW15-SP	170	RRFx	243	U2MS	196	WRK-TEMP-x	50, 242
PDLT-x	173	RS-6036	245	UxV	194	WRP-x	69
PDS-x	169	RS-8436	245	UxV-4	194	WRPFD-x	81
PDT-x	176-177	RSH4Ax	190	U317	194	WR-RAP-x	81
PDW-12X220J	182	RSH4Sx	190	UxMP	194	WR-RR-x	81
PFD-x	48	RULER	245	UCP-x	237-238	WRS-x	69
PFD-WMRK-x	23	S12x	149	UDx	203	WS1-ISRK-21G	105
PHBL-x	232	Sx	231	UFA-x	197	WSx-Mx-x	201
PHCM-x	212	S24D-x	149	UFAF-x	197	WSBx	233
PIVOT-MMR-x	125	SANGLEx	53	UMS1-x	197	WUSSx	196
PNL-CLN	244	SAX-x	83	UMSFpx	197	XLRM6	239
PPM-x	74	SBx	233	UNI-x	236		
PPM-DOx	75	SBX-x	67	UNIVx	239		
PPM-LIDx	75	SBX-FAN-K	67	UPx	210		
PROMRK-RRx	17	S-DEC	187	UPxP	210		
PROR4CN-RRx	115	SECL-x	231	UPS-x	166-167		
PROR4CN-ZRx	50	SFx	231	UPS-EBPR	166		

corporate headquarters

300 Fairfield Road, Fairfield, NJ 07004, U.S.A.
Voice: 800-266-7225 • Fax: 800-392-3955
International Voice: +1 973 839-1011
International Fax: +1 973 831-4982
middleatlantic.com

canada

Ottawa, Ontario (Canada Head Office)
113 Iber Road, Ottawa, Ontario K2S 1E7
Voice: 888-766-9770 • Fax: 888-599-5009
middleatlantic.ca

factory distribution

USA: New Jersey • California • Illinois
Canada: Ontario
The Netherlands: Eindhoven



A brand of  **legrand**®