

EMEA Catalog

RACKS AND ENCLOSURES | TECHNICAL FURNITURE | POWER | ACCESSORIES

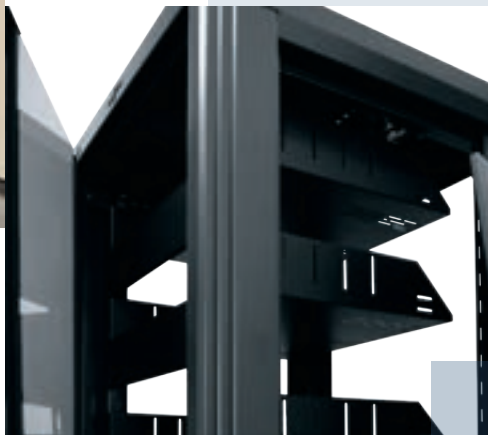

WHAT GREAT SYSTEMS ARE BUILT ON™



What Great Systems are Built on™

Middle Atlantic Products, a Brand of Legrand® has manufactured exceptional support & protection products to mount integrated AV systems in Residential, Commercial, Broadcast and Security applications since 1979.

All of our products are designed and engineered in the US to maximize

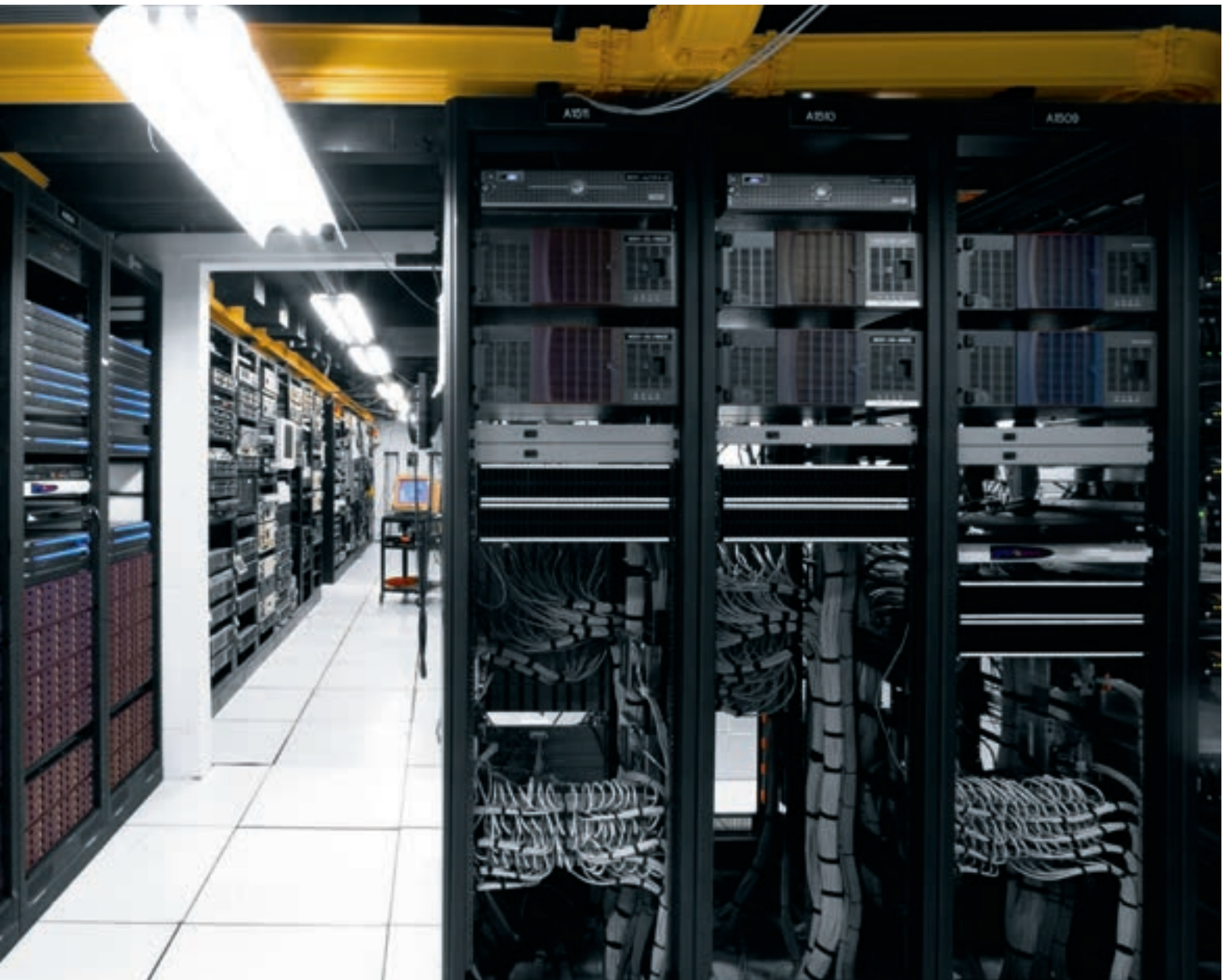

system reliability and to meet the needs of installers; from thermal considerations and built-in cable management, to pre-installed washers on our rack screws, we build in ways to save time and simplify the job.

At the heart of every installation, you'll find Middle Atlantic Products - what great systems are built on.



Customer First Philosophy

Our philosophy began as, and will always be, Customers First. Middle Atlantic's customer service team, technical support group & custom division are fully dedicated resources to ensure that we provide the right product and solution at the right time to meet our customers' needs.

Our 425,000 square foot headquarters is equipped with manufacturing capabilities such as laser fabrication cells which produce smooth edges that are friendly to both cables and



contractors, automated forming lines, robots and high-speed turret presses that provide quick throughput. It's these resources that allowed us to revolutionize the industry by stocking products nationwide to be ready on a moments notice. We've developed the broadest and deepest product lines in the industry – maximizing our customers' options, helping them consolidate vendors all while staying close to our core offering and expertise to ensure a value added experience.

Middle Atlantic Products are now fully integrated in the Legrand AV EMEA Headquarters in The Netherlands. This will allow customers to benefit from greater product availability, faster leadtimes and dedicated customer care and technical product support teams that operate in local timezones and languages.



RACKS AND ENCLOSURES

GANGABLE FLOOR-STANDING ENCLOSURES	12 - 21
BGR SERIES	12 - 13
MRK SERIES	14 - 15
VMRK SERIES	16 - 17
WRK SERIES	18 - 19
SLIM 5 SERIES	20 - 21
STAND-ALONE FLOOR-STANDING ENCLOSURES	22 - 31
BGR-SA SERIES	24 - 25
ERK SERIES	26 - 27
OPTIONS	28 - 31
WALL MOUNT RACKS AND CABINETS	32 - 47
DWR SERIES	34 - 35
EWR SERIES	36 - 37
SWR AND SBX SERIES	38 - 39
VWM SERIES	40 - 41
SFR AND WM SERIES	42 - 43
VPM AND PPM SERIES	44 - 45
HPM SERIES	46 - 47
SLIDE OUT RACKS	48 - 59
WR SERIES	50 - 51
AXS SERIES	52 - 55
AX-SXR SERIES	56 - 57
SRSR SERIES	58 - 59
SPECIALTY RACKS	60 - 73
MFR AND RFR SERIES	62 - 63
RK/BRK, OBRK AND MBRK SERIES	64 - 65
DR SERIES	66 - 67
PTRK AND CFR SERIES	68 - 69
IRCS SERIES	70 - 71
UNIVERSAL ACCESSORY OPTIONS	72 - 73

Table of Contents

TECHNICAL FURNITURE



FRAME TO FURNITURE™	74 - 79
C5 SERIES CREDENZAS	76 - 77
C3 SERIES LECTERNS	78 - 79

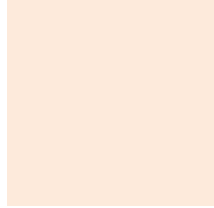

ACCESSORIES



SHELVES & STORAGE	84 - 97
CUSTOM RACKSHELVES	84 - 85
ADJUSTABLE & SLIDING SHELVES	86 - 89
RACKSHELVES	90 - 93
KEYBOARD SHELF	94
LCD RACKMOUNTS & OTHER SHELVES	95
RACKMOUNT STORAGE	96 - 97
LEVER LOCK™	98 - 101
CABLE MANAGEMENT	102 - 107
HORIZONTAL	104 - 106
VERTICAL	107
THERMAL MANAGEMENT	108 - 115
RACKMOUNT CONSOLES	116
LIGHTING	117
SECURITY OPTIONS & COVERS	118 - 119
BLANK & VENT PANELS	120 - 123
CONNECTOR PANELS	124 - 127
HARDWARE & ACCESSORIES	128 - 133

POWER



DC POWER DISTRIBUTION	82 - 83
-----------------------	---------

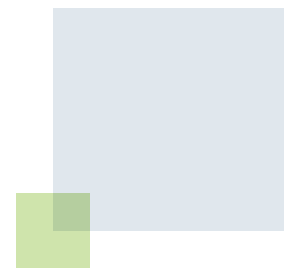

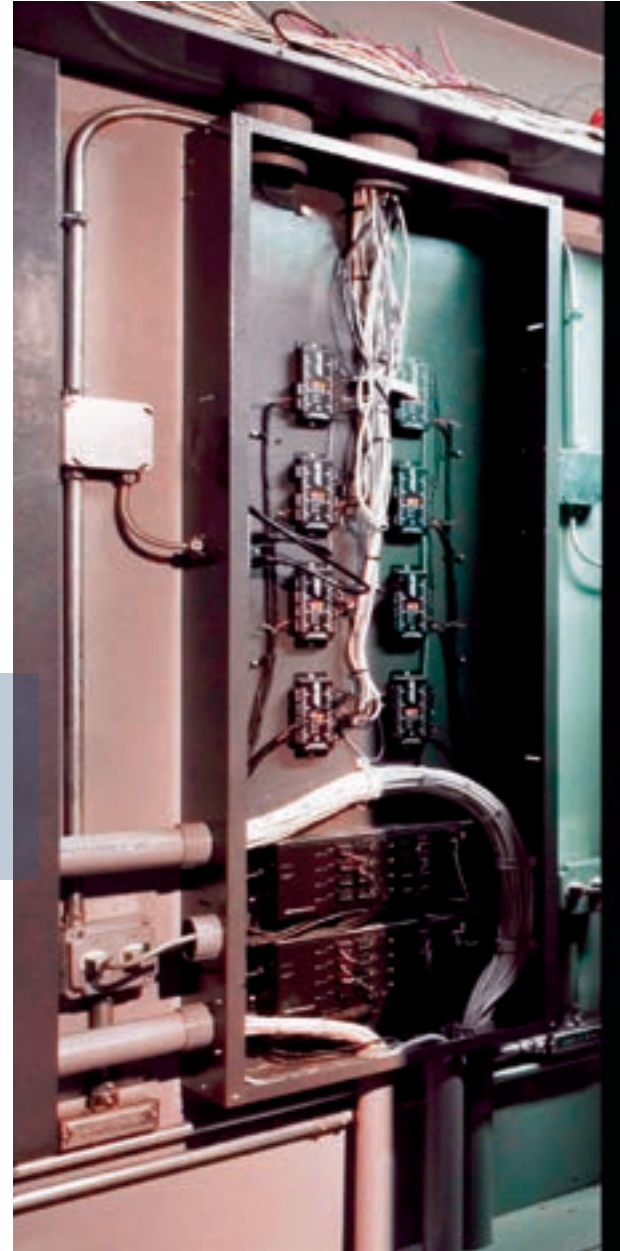

Racks and Enclosures

Racks and enclosures form the primary structure of an installation, and provide the “frame” to support electronic equipment, power, cooling and cable management.

Middle Atlantic offers the broadest and deepest range of rack solutions



in the industry to meet the needs of almost any application and maximize your options. Explore the products in the following pages or visit middleatlantic.com to find the perfect solution for you.



Gangable Floor-Standing Enclosures

Gangable racks are designed for larger installations where more than one rack is needed. Normally, they are floor-standing and feature large openings on the sides as well as front and back, and have holes or pre-installed nuts that allow the racks to be bolted together side-to-side.

(Some installers also prefer them for single-rack jobs because the open sides provide unrestricted access during installation.) Attaching the racks firmly together provides strength, stability, and allows cabling to pass between racks. Side panel sets are available to cover the



sides once the installation is complete; one set of side panels will close off an entire row of ganged racks.

Most floor-standing gangable racks range in capacity from 19 to 44 or 45 spaces, with the Extra Tall VMRK having up to 54 spaces. Solutions are also available to close off one or more sides in the middle of a row of ganged racks – perfect for blocking airflow from one rack to the next.

BGR SERIES	12 - 13
MRK SERIES	14 - 15
VMRK SERIES	16 - 17
WRK SERIES	18 - 19
SLIM 5 SERIES	20 - 21

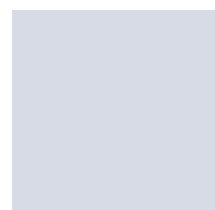



HIGHEST LEVEL OF INTEGRATION FLEXIBILITY



The BGR Series innovative rack delivers the highest level of integration flexibility and space efficiency.

- Designed to accommodate evolving AV systems
- Breakthrough design provides high strength without extra weight
- Wide open top and bottom offer many cabling and cooling options
- Standard front and rear adjustable 10-32 threaded rackrail with numbered spaces
- Includes standard vented rear door that accepts optional fans (except LRD models)
- Accepts Lever Lock™ system tool free cable management accessories, see pg. 206
- Accepts extender bay to add 76mm of useable depth to the front or rear at any time
- Accepts brush grommet rear door kit for a large cable passage without fishing

CERTIFICATIONS

- Seismic Certification
- UL
- RoHS
- GREENGUARD

MARKET SOLUTIONS



Broadcast



Commercial AV



Residential AV



Security



Structured Cabling



Education



International Fan Available



PRODUCT INFORMATION

PART #	RACKING HEIGHT	OVERALL HEIGHT	OVERALL DEPTH	USEABLE DEPTH	SIDE PANELS	ADD'L 10/32 THREADED RACKRAIL (PAIR)	ACCENT TRIM (SILVER)*
BGR-1927	845mm (19 space)	949mm	686mm	619mm	BSPN-19-27	BGR-RR19	BGR-TRIM19
BGR-2527	1111mm (25 space)	1216mm	686mm	619mm	BSPN-25-27	BGR-RR25	BGR-TRIM25
BGR-4127	1822mm (41 space)	1927mm	686mm	619mm	BSPN-41-27	BGR-RR41	BGR-TRIM41
BGR-4132	1822mm (41 space)	1927mm	813mm	746mm	BSPN-41-32	BGR-RR41	BGR-TRIM41
BGR-4527	2000mm (45 space)	2105mm	686mm	619mm	BSPN-45-27	BGR-RR45	BGR-TRIM45
BGR-4532	2000mm (45 space)	2105mm	813mm	746mm	BSPN-45-32	BGR-RR45	BGR-TRIM45

*available without rear door, suffix part # 'LRD' *accent trim also available in black, suffix part # 'B'

OPTIONS











Please refer to the enclosure options section on pgs. 44-50 or visit our website for more info.

FITS PART #	FRONT DOORS					REAR DOORS	SOLID TOP	TOP RAIL REDUCER	VENTED TOP	FAN TOPS			
	SOLID	PLEXI	VENTED	CURVED DOOR VENTED	CURVED DOOR PLEXI	CABLE ENTRY REAR DOOR**				15,63M ² /MIN	7,82M ² /MIN	15,63M ² /MIN WITH CONTROLLER	7,82M ² /MIN WITH CONTROLLER
BGR-1927	BFD-19	BPFD-19	BVFD-19	VFD-19A	PFD-19A	BGR-RDC19	-	-	-	-	-	-	-
BGR-2527	BFD-25	BPFD-25	BVFD-25	VFD-25A	PFD-25A	BGR-RDC25	-	-	-	-	-	-	-
BGR-2532	BFD-25	BPFD-25	BVFD-25	VFD-25A	PFD-25A	BGR-RDC25	-	-	-	-	-	-	-
BGR-4127	BFD-41	BPFD-41	BVFD-41	VFD-41A	PFD-41A	BGR-RDC41	BGR-STP9	BGR-TRR9	BGR-LVT9	IBGR-552FT	IBGR-276FT	IBGR-552FT-FC	IBGR-276FT-FC
BGR-4132	BFD-41	BPFD-41	BVFD-41	VFD-41A	PFD-41A	BGR-RDC41	BGR-STP9	BGR-TRR9	BGR-LVT9	IBGR-552FT	IBGR-276FT	IBGR-552FT-FC	IBGR-276FT-FC
BGR-4527	BFD-45	BPFD-45	BVFD-45	VFD-45A	PFD-45A	BGR-RDC45	BGR-STP9	BGR-TRR9	BGR-LVT9	IBGR-552FT	IBGR-276FT	IBGR-552FT-FC	IBGR-276FT-FC
BGR-4532	BFD-45	BPFD-45	BVFD-45	VFD-45A	PFD-45A	BGR-RDC45	BGR-STP9	BGR-TRR9	BGR-LVT9	IBGR-552FT	IBGR-276FT	IBGR-552FT-FC	IBGR-276FT-FC

**Order with part # 'LRD'

PART#	CABLE CHASE
BGR-CC-45FB	BGR front & back cable chase, 112mm width, fits 45 space racks
BGR-CC-41FB	BGR front & back cable chase, 112mm width, fits 41 space racks
BGR-CC-38LT	BGR top cable chase, 112mm width, 965mm deep
BGR-CC-32LT	BGR top cable chase, 112mm width, 965mm deep
BGR-CC-27LT	BGR top cable chase, 112mm width, 965mm deep

ADDITIONAL OPTIONS:

									
CBS-BGR caster kit	BS-BGR inner platform base	LF-HD leveling feet	BGR-Z4 seismic anchor kit	BGR-ISO ground isolation kit	BGR-ISO-Z4 seismic ground iso kit	BGR-STPx solid panels for 12 sp. top opening	BGR-TRRx top rail reducer kits	GANG-10T ganging hardware	Lever Lock™ see pg. 206



MULTI-BAY SPACE SAVING RACK



The MRK Series is designed for large-scale multi-bay jobs.

- Fully welded construction for strength
- Racks gang together when fully loaded
- Multiple lacing points and slotted rail brackets for cable management flexibility
- Standard front and rear adjustable 10-32 threaded rackrail with numbered spaces
- Racks with PRO suffix include two pairs of cage nut style rackrail
- Comes with standard configurable rear door; see pg. 226 for thermal management kits
- Preconfig version available see pg. 57
- Seismic certified up to 476 kgs.

CERTIFICATIONS

- Seismic Certification
- UL
- RoHS
- GREENGUARD
- OSHPOD

MARKET SOLUTIONS



Broadcast



Commercial
AV



Residential
AV



Security



Structured
Cabling



Education



International
Fan Available

PRODUCT INFORMATION

PART #	RACKING HEIGHT	OVERALL HEIGHT	USEABLE DEPTH	OVERALL DEPTH	SIDE PANELS	COMMERCIAL CASTER BASE (ADDS 24MM)	FINE FLOOR CASTER BASE (ADDS 24MM)	ADD'L 10/32 THREADED RACKRAIL	ADD'L CAGE NUT RACKRAIL
MRK-2426	1067mm (24 space)	1222mm	610mm	673mm	SPN-24-267	CBS-MRK-26	CBS-MRK-26R	MV-RR24	PROMRK-RR24
MRK-2431	1067mm (24 space)	1222mm	737mm	800mm	SPN-24-312	CBS-MRK-31	CBS-MRK-31R	MV-RR24	PROMRK-RR24
MRK-3726	1645mm (37 space)	1800mm	610mm	673mm	SPN-37-267	CBS-MRK-26	CBS-MRK-26R	MV-RR37	PROMRK-RR37
MRK-3731	1645mm (37 space)	1800mm	737mm	800mm	SPN-37-312	CBS-MRK-31	CBS-MRK-31R	MV-RR37	PROMRK-RR37
MRK-4026	1778mm (40 space)	1934mm	610mm	673mm	SPN-40-267	CBS-MRK-26	CBS-MRK-26R	MV-RR40	PROMRK-RR40
MRK-4031	1778mm (40 space)	1934mm	737mm	800mm	SPN-40-312	CBS-MRK-31	CBS-MRK-31R	MV-RR40	PROMRK-RR40
MRK-4036*	1778mm (40 space)	1934mm	851mm	914mm	SPN-40-36	CBS-MRK-36	CBS-MRK-36R	MV-RR40	PROMRK-RR40
MRK-4426*	1956mm (44 space)	2111mm	610mm	673mm	SPN-44-267	CBS-MRK-26	CBS-MRK-26R	MV-RR44	PROMRK-RR44
MRK-4431*	1956mm (44 space)	2111mm	737mm	800mm	SPN-44-312	CBS-MRK-31	CBS-MRK-31R	MV-RR44	PROMRK-RR44
MRK-4436*	1956mm (44 space)	2111mm	851mm	914mm	SPN-44-36	CBS-MRK-36	CBS-MRK-36R	MV-RR44	PROMRK-RR44
MRK-4442*	1956mm (44 space)	2111mm	1003mm	1067mm	SPN-44-423	CBS-MRK-42	-	MV-RR44	PROMRK-RR44

*available without rear door, suffix part # with 'LRD'

OPTIONS

Please refer to the enclosure options section on pgs. 44-50 or visit our website for more info.

FITS PART #	FRONT DOORS					SOLID TOP	25% OPEN AREA TOP	64% OPEN AREA PERF TOP	FAN TOPS	
	SOLID*	PLEXI	25% OPEN AREA PERF	64% OPEN AREA PERF	PLEXI VENTED				W/ (4) 114MM FANS (380 CFM TOTAL)	W/ (1) 254MM FAN (550 CFM TOTAL)
MRK-2426	FD-24	PFD-24	VFD-24	LVFD-24	-	MW-ST	MW-VT	MW-LVT	MW-4FT-380CFM	MW-10FT-550CFM
MRK-2431	FD-24	PFD-24	VFD-24	LVFD-24	-	MW-ST	MW-VT	MW-LVT	MW-4FT-380CFM	MW-10FT-550CFM
MRK-3726	FD-37	PFD-37	VFD-37	LVFD-37	-	MW-ST	MW-VT	MW-LVT	MW-4FT-380CFM	MW-10FT-550CFM
MRK-3731	FD-37	PFD-37	VFD-37	LVFD-37	-	MW-ST	MW-VT	MW-LVT	MW-4FT-380CFM	MW-10FT-550CFM
MRK-4026	FD-40	PFD-40	VFD-40	LVFD-40	-	MW-ST	MW-VT	MW-LVT	MW-4FT-380CFM	MW-10FT-550CFM
MRK-4031	FD-40	PFD-40	VFD-40	LVFD-40	-	MW-ST	MW-VT	MW-LVT	MW-4FT-380CFM	MW-10FT-550CFM
MRK-4036	FD-40	PFD-40	VFD-40	LVFD-40	-	MW-ST	MW-VT	MW-LVT	MW-4FT-380CFM	MW-10FT-550CFM
MRK-4426	FD-44	PFD-44	VFD-44	LVFD-44	PVFD-44	MW-ST	MW-VT	MW-LVT	MW-4FT-380CFM	MW-10FT-550CFM
MRK-4431	FD-44	PFD-44	VFD-44	LVFD-44	PVFD-44	MW-ST	MW-VT	MW-LVT	MW-4FT-380CFM	MW-10FT-550CFM
MRK-4436	FD-44	PFD-44	VFD-44	LVFD-44	PVFD-44	MW-ST	MW-VT	MW-LVT	MW-4FT-380CFM	MW-10FT-550CFM
MRK-4442	FD-44	PFD-44	VFD-44	LVFD-44	PVFD-44	MW-ST	MW-VT	MW-LVT	MW-4FT-380CFM	MW-10FT-550CFM



*see pg. 227 for fan panel options that fit knockouts



RUGGED, SPACE-SAVING DESIGN



The VMRK Series adds extra height to take full advantage of taller spaces.

- Specify a VMRK to maximize your racking capacity, and where seismic certification and open or removable sides are required or preferred
- Fully welded construction for strength
- 54 spaces of racking height
- Racks gang together when fully loaded
- Multiple lacing points and slotted rail brackets for cable management flexibility
- Standard front and rear adjustable 10-32 threaded with numbered spaces
- Includes standard solid locking rear door (except LRD models)

CERTIFICATIONS

- Seismic Certification
- UL/ETL Listed
- RoHS
- GREENGUARD

MARKET SOLUTIONS



Broadcast



Commercial AV



Residential AV



Security



Structured Cabling



Education



International Fan Available

PRODUCT INFORMATION

PART #	RACKING HEIGHT	OVERALL HEIGHT	USEABLE DEPTH	OVERALL DEPTH	OVERALL WIDTH	SIDE PANELS	ADD'L 10/32 THREADED Z-RAIL
VMRK-54*	2400mm (54 space)	2556mm	737mm	800mm	559mm	SPN-54-312	VRR-54

*available without rear door, suffix part # 'LRD'

OPTIONS

Please refer to the enclosure options section on pgs. 44-50 or visit our website for more info.

RACK OPTIONS: THE OPTIONS LISTED BELOW ARE THE MOST WIDELY USED ACCESSORIES FOR THIS SERIES OF ENCLOSURE BUT IS NOT INCLUSIVE OF ALL AVAILABLE ITEMS. FOR ADDITIONAL OPTIONS AND/OR MORE INFORMATION ON THE ITEMS LISTED BELOW REFERENCE THE ENCLOSURE OPTIONS SECTION OF THE CATALOG.								
FITS PART #	FRONT DOORS			REAR DOORS		SOLID TOP	FAN TOPS	
	SOLID	PLEXI	25% OPEN AREA PERF	64% OPEN AREA PERF	64% OPEN AREA PERF TOP		W/ (4) 114MM FANS (380 CFM TOTAL)	W/ (1) 254MM FAN (550 CFM TOTAL)
VMRK-54	FD-54	PFD-54	VFD-54	MW-LVRD-54	MW-ST	MW-LVT	MW-4FT-380CFM	MW-10FT-550CFM

Note: Due to flipping hazard, there is no caster base available for this rack.

WIDE AV MULTI-BAY RACK ENCLOSURE

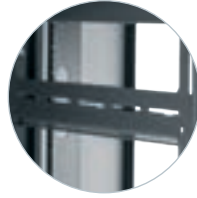

The WRK Series is designed for multi-bay jobs that require large cable capacity and greater air-flow.

- Fully welded construction for strength
- 616mm overall width provides space for side cabling or cooling airflow
- Convenient lacing points and slotted rail brackets for cable management
- Standard front and rear adjustable 10-32 threaded rackrail with numbered spaces
- Extra-wide rackrail features cable pass-throughs to facilitate front-to-rear cabling
- Comes with standard configurable rear door see pg. 227 for thermal management kits (except LRD)

For stand-alone model, refer to pgs. 36-37.

CERTIFICATIONS

- Seismic Certification
- UL/ETL Listed
- RoHS
- GREENGUARD

MARKET SOLUTIONS



Broadcast



Commercial
AV



Residential
AV



Security



Structured
Cabling



Education



International
Fan Available



PRODUCT INFORMATION

PART #	RACKING HEIGHT	OVERALL HEIGHT	USEABLE DEPTH	OVERALL DEPTH	CASTER BASE	ADD'L 10/32 THREADED RACKRAIL	ADD'L CAGE NUT RACKRAIL	LOCKABLE SIDE PANELS
WRK-24-32	1067mm (24 space)	1222mm	781mm	829mm	CBS-WRK-32	WRK-RR24	PROWRK-RR24	SPN-24-312
WRK-37-32	1645mm (37 space)	1800mm	781mm	829mm	CBS-WRK-32	WRK-RR37	PROWRK-RR37	SPN-37-312
WRK-44-27*	1956mm (44 space)	2111mm	654mm	702mm	CBS-WRK-27	WRK-RR44	PROWRK-RR44	SPN-44-267

OPTIONS Please refer to the enclosure options section on pgs. 44-50 or visit our website for more info.

RACK OPTIONS: THE OPTIONS LISTED BELOW ARE THE MOST WIDELY USED ACCESSORIES FOR THIS SERIES OF ENCLOSURE BUT IS NOT INCLUSIVE OF ALL AVAILABLE ITEMS. FOR ADDITIONAL OPTIONS AND/OR MORE INFORMATION ON THE ITEMS LISTED BELOW REFERENCE THE ENCLOSURE OPTIONS SECTION OF THE CATALOG.

FITS PART #	FRONT DOORS					REAR DOORS		SOLID TOP	VENTED TOP	FAN TOPS	
	SOLID*	PLEXI	25% OPEN AREA PERF	64% OPEN AREA PERF	PLEXI VENTED	64% OPEN AREA PERF	79% PERF SPLIT DOOR			W/ (4) 114MM FANS (380 CFM TOTAL)	W/ (1) 254MM FAN (550 CFM TOTAL)
WRK-24-32	FD-24	PFD-24	VFD-24	LVFD-24	-	-	-	MW-ST	MW-LVT	MW-4FT-380CFM	MW-10FT-550CFM
WRK-37-32	FD-37	PFD-37	VFD-37	LVFD-37	-	-	-	MW-ST	MW-LVT	MW-4FT-380CFM	MW-10FT-550CFM
WRK-44-32	FD-44	PFD-44	VFD-44	LVFD-44	PVFD-44	MW-LVRD-44	MW-CLVRD-44	MW-ST	MW-LVT	MW-4FT-380CFM	MW-10FT-550CFM



*see pg. 227 for fan panel options that fit knockouts

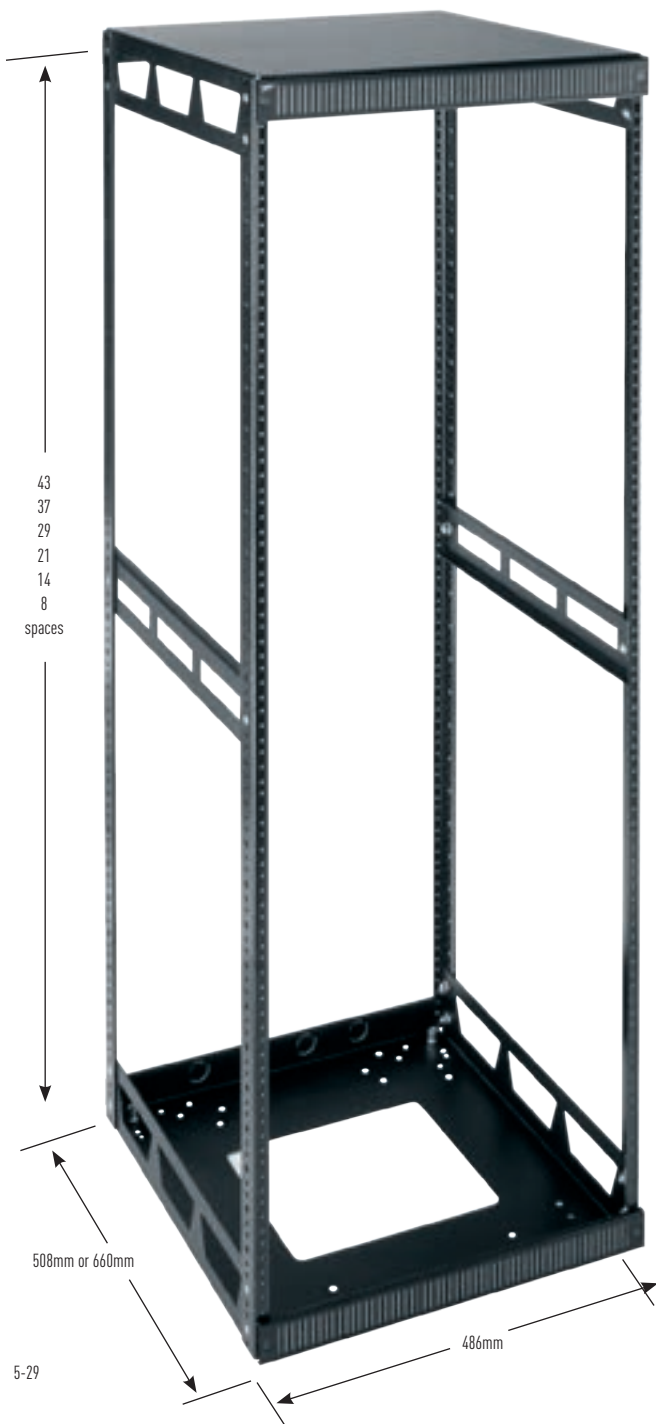

COST EFFECTIVE VERSATILE MULTI-BAY RACK

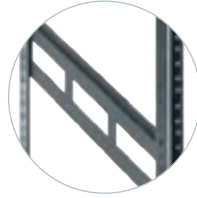

The Slim 5 Series is designed for multiple AV applications and locations.

- Available in 12 standard sizes and any height from 8 to 43 spaces
- Ships ready to assemble
- Strong steel construction with wide open access for easy integration
- Lightweight, open design is easy to work with
- Knock down design allows for flat shipment
- Unique interlocking corner joint for exceptional strength and easy assembly
- Accepts optional removable steel side panels for security and to control airflow
- Accepts optional attractive thermolaminate top and side panels (19 colors)
- Top includes two laser knockout locations to mount cooling fans
- Standard front and rear fixed 10-32 threaded rackrail with marked spaces

CERTIFICATIONS

- UL
- RoHS
- GREENGUARD

Market Solutions



Broadcast



Commercial
AV



Residential
AV



Security



Structured
Cabling



Education



International
Fan Available

GANGABLE FLOOR-STANDING ENCLOSURES

SLIM 5 SERIES

PRODUCT INFORMATION

508MM USEABLE DEPTH PART #	660MM USEABLE DEPTH PART #	RACKING HEIGHT	OVERALL HEIGHT
5-8	5-8-26	356mm (8 space)	451mm
5-14	5-14-26	622mm (14 space)	718mm
5-21	5-21-26	933mm (21 space)	1029mm
5-29	5-29-26	1289mm (29 space)	1384mm
5-37	5-37-26	1645mm (37 space)	1740mm
5-43	5-43-26	1911mm (43 space)	2007mm



- For a professional finished look try trim strips – see pg. 241

OPTIONS Please refer to the enclosure options section on pgs. 44-50 or visit our website for more info.

FITS PART #	SOLID FRONT DOOR	PLEXI FRONT DOOR	STEEL SIDE PANELS, PAIR	THERMOLAMINATE TOP/SIDE PANELS**	REAR ACCESS PANEL	ADJUSTABLE "SPLIT" REAR RACKRAIL	CABLE CHASE 76MM WIDE*
5-8	DO-5-8	DOP-5-8	SP-5-8	-	RAP8	5AR8	5CC8
5-14	DO-5-14	DOP-5-14	SP-5-14	TSP-5-14xx	RAP14	5AR14	5CC14
5-21	DO-5-21	DOP-5-21	SP-5-21	TSP-5-21xx	RAP21	5AR21	5CC21
5-29	DO-5-29	DOP-5-29	SP-5-29	TSP-5-29xx	RAP29	5AR29	5CC29
5-37	DO-5-37	DOP-5-37	SP-5-37	TSP-5-37xx	RAP37	5AR37	5CC37
5-43	DO-5-43	DOP-5-43	SP-5-43	TSP-5-43xx	RAP43	5AR43	5CC43
5-8-26	DO-5-8	DOP-5-8	SP-5-8-26	-	RAP8	5AR8-26	5CC8-26
5-14-26	DO-5-14	DOP-5-14	SP-5-14-26	TSP-5-14-26xx	RAP14	5AR14-26	5CC14-26
5-21-26	DO-5-21	DOP-5-21	SP-5-21-26	TSP-5-21-26xx	RAP21	5AR21-26	5CC21-26
5-29-26	DO-5-29	DOP-5-29	SP-5-29-26	TSP-5-29-26xx	RAP29	5AR29-26	5CC29-26
5-37-26	DO-5-37	DOP-5-37	SP-5-37-26	TSP-5-37-26xx	RAP37	5AR37-26	5CC37-26
5-43-26	DO-5-43	DOP-5-43	SP-5-43-26	TSP-5-43-26xx	RAP43	5AR43-26	5CC43-26

*Custom width cable chases available, please call for details.



Stand-Alone Floor-Standing Enclosures

Stand-alone racks are designed to house all types of electronic systems in smaller installations where one rack is sufficient for the need, or for where multiple racks are used but are not standing together in a row.

Racks in this section are floor-standing and have solid sides for strength, security, and to control cooling airflow.



For most models, a variety of options are available, including front and rear doors, solid, vented and fan tops, and caster and riser bases. Stand-alone racks range in capacity from 18 to 45 rack spaces at multiple depths.

BGR-SA SERIES	24 - 25
ERK SERIES	26 - 27
OPTIONS	28 - 31

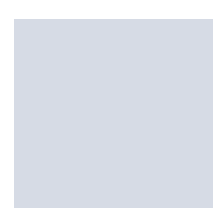



HIGHEST LEVEL OF SPACE EFFICIENCY



The BGR-SA Series has the highest level of space efficiency, strength and flexibility.

- Designed to accommodate evolving AV systems
- Breakthrough design provides high strength without extra weight
- Wide open top and bottom offer many cabling and cooling options
- Fixed solid side for security and to control airflow
- Standard front and rear adjustable 10-32 threaded rackrail with numbered spaces
- Includes standard vented rear door that accepts optional fans (Except LRD models)
- Accepts Lever Lock™ system tool free cable management accessories (see pg. 206)
- Accepts extender bay to add 76mm of useable depth to the front or rear at any time
- Accepts brush grommet rear door kit for a large cable passage without fishing

CERTIFICATIONS

- Seismic Certification
- UL/ETL Listed
- RoHS
- GREENGUARD
- OSHPOD

MARKET SOLUTIONS



Broadcast



Commercial AV



Residential AV



Security



Structured Cabling



Education



International Fan Available

PRODUCT INFORMATION

PART #*	RACKING HEIGHT	OVERALL HEIGHT	OVERALL DEPTH	USEABLE DEPTH	ADD'L 10/32 THREADED RACKRAIL (PAIR)	ACCENT TRIM (SILVER)
BGR-19SA-27	845mm (19 space)	949mm	686mm	619mm	BGR-RR19	BGR-TRIM19
BGR-25SA-27	1111mm (25 space)	1216mm	686mm	619mm	BGR-RR25	BGR-TRIM25
BGR-38SA-32	1689mm (38 space)	1794mm	813mm	746mm	BGR-RR38	BGR-TRIM38
BGR-41SA-27	1822mm (41 space)	1927mm	686mm	619mm	BGR-RR41	BGR-TRIM41
BGR-45SA-27	2000mm (45 space)	2105mm	686mm	619mm	BGR-RR45	BGR-TRIM45

*available without rear door, suffix part # 'LRD'. *accent trim also available in black, suffix part # 'B'

OPTIONS

















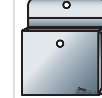

Please refer to the enclosure options section on pgs. 44-50 or visit our website for more info.

FITS PART #	FRONT DOORS					REAR DOORS				FAN TOPS				
	SOLID	PLEXI	VENTED	CURVED DOOR VENTED	CURVED DOOR PLEXI	CABLE ENTRY REAR DOOR**	SOLID TOP	TOP RAIL REDUCER	VENTED TOP	DUCT-COOL™ ADAPTER TOP	15,63M ³ /MIN	7,82M ³ /MIN	15,63M ³ /MIN WITH CONTROLLER	7,82M ³ /MIN WITH CONTROLLER
BGR-19SA-27	BFD-19	BPFD-19	BVFD-19	VFD-19A	PFD-19A	BGR-RDC19	-	-	-	-	-	-	-	-
BGR-25SA-27	BFD-25	BPFD-25	BVFD-25	VFD-25A	PFD-25A	BGR-RDC25	-	-	-	-	-	-	-	-
BGR-38SA-27	BFD-38	BPFD-38	BVFD-38	VFD-38A	PFD-38A	BGR-RDC38	BGR-STP9	BGR-TRR9	BGR-LVT9	BGR-DT9	IBGR-552FT	IBGR-276FT	IBGR-552FT-FC	IBGR-276FT-FC
BGR-41SA-27	BFD-41	BPFD-41	BVFD-41	VFD-41A	PFD-41A	BGR-RDC41	BGR-STP9	BGR-TRR9	BGR-LVT9	BGR-DT9	IBGR-552FT	IBGR-276FT	IBGR-552FT-FC	IBGR-276FT-FC
BGR-45SA-27	BFD-45	BPFD-45	BVFD-45	VFD-45A	PFD-45A	BGR-RDC45	BGR-STP9	BGR-TRR9	BGR-LVT9	BGR-DT9	IBGR-552FT	IBGR-276FT	IBGR-552FT-FC	IBGR-276FT-FC
BGR-45SA-32	BFD-45	BPFD-45	BVFD-45	VFD-45A	PFD-45A	BGR-RDC45	BGR-STP9	BGR-TRR9	BGR-LVT9		IBGR-552FT	IBGR-276FT	IBGR-552FT-FC	IBGR-276FT-FC

*All fan tops come with blank panels to close top of rack. **Only compatible with 'LRD' models.

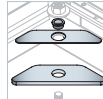
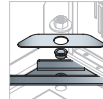
PART#	CABLE CHASE
BGR-CC-45FB	BGR front & back cable chase, 112mm width, fits 45 space racks
BGR-CC-41FB	BGR front & back cable chase, 112mm width, fits 41 space racks
BGR-CC-32LT	BGR top cable chase, 112mm width, 965mm deep
BGR-CC-27LT	BGR top cable chase, 112mm width, 965mm deep

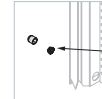
ADDITIONAL OPTIONS:

									
BGR-45EXT3 76mm front or rear extender	BGR-CC-xxFB cable chase lift off	BGR-CC-xxLT cable chase top only	BGR-TRIMxx silver front trim kit	BGR-TRIMxxB black front trim kit	BGR-RDxx cable entry rear door	TDRIFT drift pins for ganging racks	VBK-BGR vent blocker kit	DOC-SACK rear door document pocket	BGR-DT9 duct cool adapter
									
CBS-BGR caster kit	BS-BGR inner platform base	LF-HD leveling feet	BGR-Z4 seismic anchor kit	BGR-ISO ground isolation kit	BGR-ISO-Z4 seismic ground iso kit	BGR-STPx solid panels for 12 sp. top opening	BGR-TRRx top rail reducer kits	GANG-10T ganging hardware	Lever Lock™ see pg. 206

COST EFFECTIVE STAND-ALONE RACK

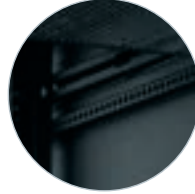

The ERK Series stand-alone rack has multi-bay capabilities for thermal management control, future growth or other purposes.

- Fully welded construction for strength
- Enclosure sides include top and bottom venting
- Convenient lacing points and slotted rail brackets for cable management
- Standard front adjustable 10-32 threaded rackrail with numbered spaces
- Comes with standard configurable rear door
- Ready-to-assemble knock down models are also available
- Preconfig version available see pg. 56

CERTIFICATIONS

- Seismic Certification
- UL2416
- RoHS
- GREENGUARD

MARKET SOLUTIONS



Broadcast



Commercial
AV



Residential
AV



Security



Structured
Cabling



Education



International
Fan Available



ERK-4425

STAND-ALONE FLOOR-STANDING ENCLOSURES

ERK SERIES

RACKS AND ENCLOSURES

PRODUCT INFORMATION

PART #*	RACKING HEIGHT	OVERALL HEIGHT	USEABLE DEPTH	OVERALL DEPTH	SKIRTED WHEELBASE (ADDS 95MM)	ADDITIONAL RACKRAIL
ERK-1820	800mm (18 space)	905mm	470mm	508mm	CBS-ERK-20	ERK-RR18
ERK-1825	800mm (18 space)	905mm	597mm	635mm	CBS-ERK-25	ERK-RR18
ERK-2120	933mm (21 space)	1038mm	470mm	508mm	CBS-ERK-20	ERK-RR21
ERK-2125	933mm (21 space)	1038mm	597mm	635mm	CBS-ERK-25	ERK-RR21
ERK-2720	1200mm (27 space)	1305mm	470mm	508mm	CBS-ERK-20	ERK-RR27
ERK-2725	1200mm (27 space)	1305mm	597mm	635mm	CBS-ERK-25	ERK-RR27
ERK-3520	1556mm (35 space)	1661mm	470mm	508mm	CBS-ERK-20	ERK-RR35
ERK-3525	1556mm (35 space)	1661mm	597mm	635mm	CBS-ERK-25	ERK-RR35
ERK-4020	1778mm (40 space)	1883mm	470mm	508mm	CBS-ERK-20	ERK-RR40
ERK-4025	1778mm (40 space)	1883mm	597mm	635mm	CBS-ERK-25	ERK-RR40
ERK-4420	1956mm (44 space)	2061mm	470mm	508mm	CBS-ERK-20	ERK-RR44
ERK-4425	1956mm (44 space)	2061mm	597mm	635mm	CBS-ERK-25	ERK-RR44

*available without rear door, suffix part # 'LRD'



*see pg. 227 for fan panel options that fit knockouts

OPTIONS

Please refer to the enclosure options section on pgs. 44-50 or visit our website for more info.

FITS PART #	FRONT DOORS				REAR DOOR		64% OPEN AREA PERF TOP	SOLID TOP	VENTED TOP	FAN TOPS	
	SOLID*	PLEXI	25% OPEN AREA PERF	64% OPEN AREA PERF	TOP & BOTTOM SLOT VENTED	CABLE ENTRY				W/ (3) 114MM FANS (285 CFM TOTAL)	W/ (1) 254MM FAN (550 CFM TOTAL)
ERK-1820	FD-18	PFD-18	VFD-18	LVFD-18	ERK-VRD-18	ERK-RDC18	-	-	-	-	-
ERK-1825	FD-18	PFD-18	VFD-18	LVFD-18	ERK-VRD-18	ERK-RDC18	-	-	-	-	-
ERK-2120	FD-21	PFD-21	VFD-21	LVFD-21	ERK-VRD-21	ERK-RDC21	-	-	-	-	-
ERK-2125	FD-21	PFD-21	VFD-21	LVFD-21	ERK-VRD-21	ERK-RDC21	-	-	-	-	-
ERK-2720	FD-27	PFD-27	VFD-27	-	ERK-VRD-27	ERK-RDC27	-	-	-	-	-
ERK-2725	FD-27	PFD-27	VFD-27	-	ERK-VRD-27	ERK-RDC27	-	-	-	-	-
ERK-3520	FD-35	PFD-35	VFD-35	LVFD-35	ERK-VRD-35	ERK-RDC35	ERK-LVT	ERK-ST	ERK-VT	ERK-4FT-285CFM	ERK-10FT-550CFM
ERK-3525	FD-35	PFD-35	VFD-35	LVFD-35	ERK-VRD-35	ERK-RDC35	ERK-LVT	ERK-ST	ERK-VT	ERK-4FT-285CFM	ERK-10FT-550CFM
ERK-4020	FD-40	PFD-40	VFD-40	LVFD-40	ERK-VRD-40	ERK-RDC40	ERK-LVT	ERK-ST	ERK-VT	ERK-4FT-285CFM	ERK-10FT-550CFM
ERK-4025	FD-40	PFD-40	VFD-40	LVFD-40	ERK-VRD-40	ERK-RDC40	ERK-LVT	ERK-ST	ERK-VT	ERK-4FT-285CFM	ERK-10FT-550CFM
ERK-4420	FD-44	PFD-44	VFD-44	LVFD-44	ERK-VRD-44	ERK-RDC44	ERK-LVT	ERK-ST	ERK-VT	ERK-4FT-285CFM	ERK-10FT-550CFM
ERK-4425	FD-44	PFD-44	VFD-44	LVFD-44	ERK-VRD-44	ERK-RDC44	ERK-LVT	ERK-ST	ERK-VT	ERK-4FT-285CFM	ERK-10FT-550CFM



CBS-ERK-20R

SKIRTED CASTER BASES

Adds 95mm overall height. Commercial grade casters are UL Listed and have a weight capacity of 590 kg. Fine floor casters protect flooring with a weight capacity of 318 kg.

COMMERCIAL GRADE CASTER BASE PART #	FINE FLOOR CASTER BASE PART #	FITS	RACK DEPTH
CBS-5	CBS-5R	Slim 5	508mm
CBS-5-26	CBS-5-26R	Slim 5	660mm
CBS-ERK-20	CBS-ERK-20R	ERK	508mm
CBS-ERK-25	CBS-ERK-25R	ERK	635mm



CBS-MRK-31

RECESSED CASTER BASES

Adds 24mm overall height. Wheels come pre-installed and work with LF leveling feet. Commercial grade casters are UL Listed and have a weight capacity of 590 kg. The fine floor casters protect flooring with a weight capacity of 318 kg.

COMMERCIAL GRADE CASTER BASE PART #	FINE FLOOR CASTER BASE PART #	FITS	RACK DEPTH
CBS-BGR		BGR	all
CBS-WRK-27	CBS-WRK-27R	WRK	686mm
CBS-WRK-32	CBS-WRK-32R	WRK	813mm
CBS-MRK-26	CBS-MRK-26R	MRK	660mm
CBS-MRK-31	CBS-MRK-31R	MRK	787mm
CBS-MRK-36	CBS-MRK-36R	MRK	914mm



LF

LEVELING FEET

Adjustable leveling feet fit Middle Atlantic floor standing steel racks that can be adjusted with a flat blade screwdriver or hex driver. One set required per rack.

PART #	DESCRIPTION	FITS
LF	10mm leveling feet	DRK, ERK, WRK, WRK-SA, VMRK, MRK
LF-HD	13mm leveling feet	BRG, BGR-SA, WMRK, SNE
LF-ISO	isolation leveling feet	DRK, ERK, WRK, WRK-SA, VMRK, MRK

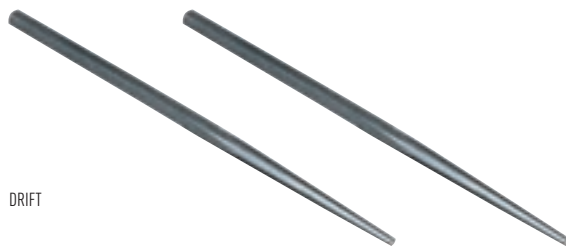

DRIFT

GANGING HARDWARE

Time-saving ganging hardware provides easy field alignment and joining of multi-bay enclosures.

PART #	DESCRIPTION
MAG-1/2	set of two 13mm magnetic sockets
GANG-10	8mm nuts/bolts to gang 10 racks or consoles



5WR

SWIVEL CASTERS

Bolt to bottom of all ERK and Slim 5 series rack systems adding 98mm overall height.

PART #	DESCRIPTION	WEIGHT CAPACITY	FITS
5W	set of 4 commercial grade casters	590 kg	ERK, Slim 5
5WL	set of 4 commercial locking grade casters	590 kg	ERK, Slim 5
5WR	set of 4 fine floor casters	318 kg	ERK, Slim 5
5WLR	set of 4 locking fine floor casters	318 kg	ERK, Slim 5

SOLID AND VENTED TOP OPTIONS

Select solid, slot pattern vented, or large perforated vented top options to address your thermal management needs.

PART #	FITS	STYLE
BGR-STP	BGR	solid
ERK-ST	ERK, WMRK	solid
ERK-VT	ERK, WMRK	slot pattern vented
ERK-LVT	ERK, WMRK	vented, 64% open area
MW-ST	DRK, MRK, VRK, VMRK, WRK, WRK	solid
MW-VT	DRK, MRK, VRK, VMRK, WRK, WRK	slot pattern vented
MW-LVT	DRK, MRK, VRK, VMRK, WRK, WRK	vented, 64% open area



MW-VT

FAN TOP OPTIONS - NON-POPULATED

Top options accept 114mm, 152mm or 254mm fans for active thermal management. See pg. 226 for fans.

PART #	FITS	FAN OPENINGS	STYLE
ERK-4FT	ERK, WMRK	laser knockouts	mounts up to four 114mm fans (MW-4FT) or three 114mm fans (ERK-4FT)
ERK-10FT	ERK, WMRK	finished hole	mounts one 254mm fan
MW-4FT	DRK, MRK, VRK, VMRK, WR, WRK	laser knockouts	mounts up to four 114mm fans (MW-4FT) or three 114mm fans (ERK-4FT) or up to 4 grommets (GK-46) for cable pass-through
MW-10FT	DRK, MRK, VRK, VMRK, WR, WRK	finished hole	mounts one 254mm fan

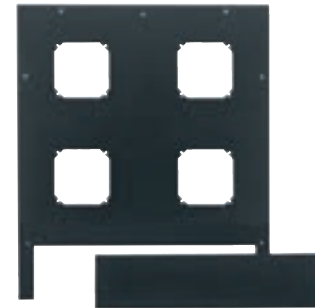

MW-4FT

TOP OPTIONS - INCLUDING FANS

Ships assembled. Integrated fan tops include 114mm, 152mm or 254mm fans, fan guards.

PART #	FITS	# OF FANS	FREE AIR CFM
IBGR-276FT*	BGR	four quiet 114mm fans	276
IBGR-552FT*	BGR	eight quiet 114mm fans	552

*Power supply wide range input 100VAC – 2240VAC and 50/60Hz compatible



MW-6FT-660CFM

THERMOSTATICALLY CONTROLLED INTEGRATED FAN TOP OPTIONS

Fan tops ship fully assembled and include 114mm, 152mm or 254mm fans, fan guards and proportional speed fan controller that increases fan life, reduces noise, saves energy, and reduces dust build up. ETL Listed in the US and Canada.

PART #	FITS	# OF FANS	FREE AIR CFM
IBGR-276FT-FC*	BGR	four quiet 114mm fans	276
IBGR-552FT-FC*	BGR	eight quiet 114mm fans	552

*Power supply wide range input 100VAC – 2240VAC and 50/60Hz compatible



LOCKING FRONT DOORS

Offered in lightly smoked plexi, 25% open area perf, 64% open area perf, plexi-vented and solid configurations. Beveled corners provide a stylish modern appearance while hinging either left or right. Black textured powder coat finish. Includes keylock.



BVFD-45



PFD-45



VFD-45

SOLID PART #	PLEXI PART #	CURVED PLEXI PART #	25% OPEN AREA PERF VENTED PART #	64% OPEN AREA PERF VENTED PART #	CURVED VENTED PART #	PLEXI VENTED PART #	SOLID SPLIT PART #	79% OPEN AREA SPLIT PERF PART #	FULLY VENTED PART #	FITS	# OF RACKSPACES
BFD-19	BPFD-19	PFD-19A	-	-	VFD-19A	BVFD-19	-	-	-	BGR	19
BFD-25	BPFD-25	PFD-25A	-	-	VFD-25A	BVFD-25	-	-	-	BGR	25
BFD-38	BPFD-38	PFD-38A	-	-	VFD-38A	BVFD-38	-	-	-	BGR	38
BFD-41	BPFD-41	PFD-41A	-	-	VFD-41A	BVFD-41	-	-	-	BGR	41
BFD-45	BPFD-45	PFD-45A	-	-	VFD-45A	BVFD-45	-	-	-	BGR	45
-	DPFD-44	-	DVFD-44	DIVRD-447	-	DPVFD-44	DCRD-44	DCLVRD-44	DFVRD-44	DRK	44
FD-8	PFD-8	-	VFD-8	LVFD-8	-	-	-	-	-	DWR, ERK, MRK, SR, VRK, VMRK, WRK	8
FD-10	PFD-10	-	VFD-10	LVFD-10	-	-	-	-	-	DWR, ERK, MRK, SR, VRK, VMRK, WRK	10
FD-12	PFD-12	-	VFD-12	LVFD-12	-	-	-	-	-	DWR, ERK, MRK, SR, VRK, VMRK, WRK	12
FD-16	PFD-16	-	VFD-16	LVFD-16	-	-	-	-	-	DWR, ERK, MRK, SR, VRK, VMRK, WRK	16
FD-18	PFD-18	-	VFD-18	LVFD-18	-	-	-	-	-	DWR, ERK, MRK, SR, VRK, VMRK, WRK	18
FD-21	PFD-21	-	VFD-21	LVFD-21	-	-	-	-	-	DWR, ERK, MRK, SR, VRK, VMRK, WRK	21
FD-24	PFD-24	-	VFD-24	LVFD-24	-	-	-	-	-	DWR, ERK, MRK, SR, VRK, VMRK, WRK	24
FD-27	PFD-27	-	VFD-27	LVFD-27	-	-	-	-	-	DWR, ERK, MRK, SR, VRK, VMRK, WRK	27
FD-35	PFD-35	-	VFD-35	LVFD-35	-	-	-	-	-	DWR, ERK, MRK, SR, VRK, VMRK, WRK	35
FD-37	PFD-37	-	VFD-37	LVFD-37	-	-	-	-	-	DWR, ERK, MRK, SR, VRK, VMRK, WRK	37
FD-40	PFD-40	-	VFD-40	LVFD-40	-	-	-	-	-	DWR, ERK, MRK, SR, VRK, VMRK, WRK	40
FD-42	PFD-42	-	VFD-42	LVFD-42	-	-	-	-	-	DWR, ERK, MRK, SR, VRK, VMRK, WRK	42
FD-44	PFD-44	-	VFD-44	LVFD-44	-	PVFD-44	-	-	-	DWR, ERK, MRK, SR, VRK, VMRK, WRK	44
FD-45	PFD-45	-	VFD-45	LVFD-45	-	-	-	-	-	DWR, ERK, MRK, SR, VRK, VMRK, WRK	45
FD-46	PFD-46	-	VFD-46	LVFD-46	-	-	-	-	-	DWR, ERK, MRK, SR, VRK, VMRK, WRK	46
FD-54	PFD-54	-	VFD-54	LVFD-54	-	-	-	-	-	DWR, ERK, MRK, SR, VRK, VMRK, WRK	54

REAR DOORS

Substitute a vented rear door for a solid rear door in selected sizes. Black textured powder coat finish. Fully vented rear doors have 64% open area. Split rear doors with 3 point latch offer 79% open area and require less floor space when accessing rear equipment connections.



DCLVRD-44



MW-LVRD-44



MW-CRD-44

SOLID SPLIT PART #	TOP & BOTTOM VENTED SLOT VENTED PART #	SLOT VENTS FULLY VENTED PART #	64% OPEN AREA SPLIT PERF PART #	79% OPEN AREA PERF PART #	FITS	# OF RACKSPACES
-	ERK-VRD-18	-	-	-	ERK	18
-	ERK-VRD-21	-	-	-	ERK	21
MW-CRD-24	-	-	-	MW-CLVRD-24	MRK, VRK, VMRK, WRK	24
-	ERK-VRD-27	-	-	-	ERK	27
-	ERK-VRD-35	-	-	-	ERK	35
-	-	-	-	-	MRK, VRK, VMRK, WRK	40
MW-CRD-42	-	-	-	MW-CLVRD-42	MRK, VRK, VMRK, WRK	42
DCRD-44	DVRD-44	DFVRD-44	DSVRD-44	DCLVRD-44	DRK	44
-	ERK-VRD-44	-	-	-	ERK	44
MW-CRD-44	MW-VRD-44	-	MW-LVRD-44	MW-CLVRD-44	MRK, VRK, VMRK, WRK	44
MW-CRD-45	-	-	-	MW-CLVRD-45	MRK, VRK, VMRK, WRK	45



Wall Mount Racks and Cabinet



Wall racks save floor space and are ideal for smaller installations or to house system distribution points. Many wall rack styles are available to meet a wide range of project needs.

Open-frame styles are great for controlled spaces such as utility rooms and some models can be mounted over conduit and similar obstructions.



Enclosed models provide security to protect equipment in more open spaces from tampering, dust, and other hazards, and many styles have hinged center sections to provide enhanced rear access to equipment and wiring. Wall racks range in capacity from 2 to 35 rackspaces

DWR SERIES	34 - 35
EWR SERIES	36 - 37
SWR AND SBX SERIES	38 - 39
WVM SERIES	40 - 41
SFR AND WM SERIES	42 - 43
VPM AND PPM SERIES	44 - 45
HPM AND DTRK SERIES	46 - 47

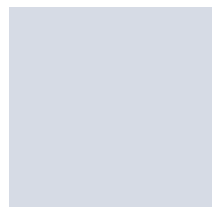



PIVOTING SECTIONAL WALL CABINET



The DWR Series provides access to rear equipment connections for medium to small systems.

- Robust welded steel construction
- Patented tool free Quick-Mount™ system for center section mounting
- Center section swing is reversible, and can be both keylocked and padlocked
- Center section is keyed differently from optional front door for security
- Designed for choice of active or passive cooling

CERTIFICATIONS

- Seismic Certification
- UL Listed
- RoHS
- UL2416
- OSHPOD

MARKET SOLUTIONS



Broadcast



Commercial AV



Residential AV



Security



Structured Cabling



Education



International Fan Available

DWR-35-22PD

PRODUCT INFORMATION

PART #	FULLY ASSEMBLED WITH PLEXI FRONT DOOR PART #	RACKING HEIGHT	OVERALL HEIGHT	USEABLE DEPTH	OVERALL DEPTH	UL LOAD CAPACITY
DWR-10-17	DWR-10-17PD	445mm (10 space)	622mm	381mm	432mm	91 kg
DWR-10-22	DWR-10-22PD	445mm (10 space)	622mm	508mm	559mm	91 kg
DWR-12-17	DWR-12-17PD	533mm (12 space)	711mm	381mm	432mm	91 kg
DWR-12-22	DWR-12-22PD	533mm (12 space)	711mm	508mm	559mm	91 kg
DWR-12-26	DWR-12-26PD	533mm (12 space)	711mm	610mm	660mm	91 kg
DWR-12-32	-	533mm (12 space)	711mm	762mm	813mm	91 kg
DWR-16-17	DWR-16-17PD	711mm (16 space)	889mm	381mm	432mm	91 kg
DWR-16-22	DWR-16-22PD	711mm (16 space)	889mm	508mm	559mm	91 kg
DWR-18-17	DWR-18-17PD	800mm (18 space)	978mm	381mm	432mm	113 kg
DWR-18-22	DWR-18-22PD	800mm (18 space)	978mm	508mm	559mm	113 kg
DWR-18-26	DWR-18-26PD	800mm (18 space)	978mm	610mm	660mm	113 kg
DWR-18-32	-	800mm (18 space)	978mm	762mm	813mm	113 kg
DWR-21-17	DWR-21-17PD	933mm (21 space)	1111mm	381mm	432mm	113 kg
DWR-21-22	DWR-21-22PD	933mm (21 space)	1111mm	508mm	559mm	113 kg
DWR-24-17	DWR-24-17PD	1067mm (24 space)	1245mm	381mm	432mm	136 kg
DWR-24-22	DWR-24-22PD	1067mm (24 space)	1245mm	508mm	559mm	136 kg
DWR-24-32	-	1067mm (24 space)	1245mm	762mm	813mm	136 kg
DWR-35-17	-	1556mm (35 space)	1734mm	381mm	432mm	136 kg
DWR-35-22	DWR-35-22PD	1556mm (35 space)	1734mm	508mm	559mm	136 kg
DWR-35-26	DWR-35-26PD	1556mm (35 space)	1734mm	610mm	660mm	136 kg

OPTIONS

Please visit our website for more info.

FITS PART #	FRONT DOORS				EXHAUST FAN KIT	ADDITIONAL 10-32 THREADED RACKRAIL
	SOLID	PLEXI	25% OPEN AREA PERF	64% OPEN AREA PERF		
DWR-10-17	FD-10	PFD-10	VFD-10	LVFD-10	DWR-FK17	DWR-RR10
DWR-10-22	FD-10	PFD-10	VFD-10	LVFD-10	DWR-FK22	DWR-RR10
DWR-12-17	FD-12	PFD-12	VFD-12	LVFD-12	DWR-FK17	DWR-RR12
DWR-12-22	FD-12	PFD-12	VFD-12	LVFD-12	DWR-FK22	DWR-RR12
DWR-12-26	FD-12	PFD-12	VFD-12	LVFD-12	DWR-FK26	DWR-RR12
DWR-12-32	FD-12	PFD-12	VFD-12	LVFD-12	DWR-FK32	DWR-RR12
DWR-16-17	FD-16	PFD-16	VFD-16	LVFD-16	DWR-FK17	DWR-RR16
DWR-16-22	FD-16	PFD-16	VFD-16	LVFD-16	DWR-FK22	DWR-RR16
DWR-18-17	FD-18	PFD-18	VFD-18	LVFD-18	DWR-FK17	DWR-RR18
DWR-18-22	FD-18	PFD-18	VFD-18	LVFD-18	DWR-FK22	DWR-RR18
DWR-18-26	FD-18	PFD-18	VFD-18	LVFD-18	DWR-FK26	DWR-RR18
DWR-18-32	FD-18	PFD-18	VFD-18	LVFD-18	DWR-FK32	DWR-RR18
DWR-21-17	FD-21	PFD-21	VFD-21	LVFD-21	DWR-FK17	DWR-RR21
DWR-21-22	FD-21	PFD-21	VFD-21	LVFD-21	DWR-FK22	DWR-RR21
DWR-24-17	FD-24	PFD-24	VFD-24	LVFD-24	DWR-FK17	DWR-RR24
DWR-24-22	FD-24	PFD-24	VFD-24	LVFD-24	DWR-FK22	DWR-RR24
DWR-24-32	FD-24	PFD-24	VFD-24	LVFD-24	DWR-FK32	DWR-RR24
DWR-35-17	FD-35	PFD-35	VFD-35	LVFD-35	DWR-FK17	DWR-RR35
DWR-35-22	FD-35	PFD-35	VFD-35	LVFD-35	DWR-FK22	DWR-RR35
DWR-35-26	FD-35	PFD-35	VFD-35	LVFD-35	DWR-FK26	DWR-RR35

Additional Options:



DWR-CVR
cover plate/shelf kit



DWRSR-ZL
minimum clearance latch for
side-by-side wall rackmounting

ECONOMICAL PIVOTING WALL CABINET



The EWR Series provides access to rear equipment connections for medium to small systems at an aggressive price.

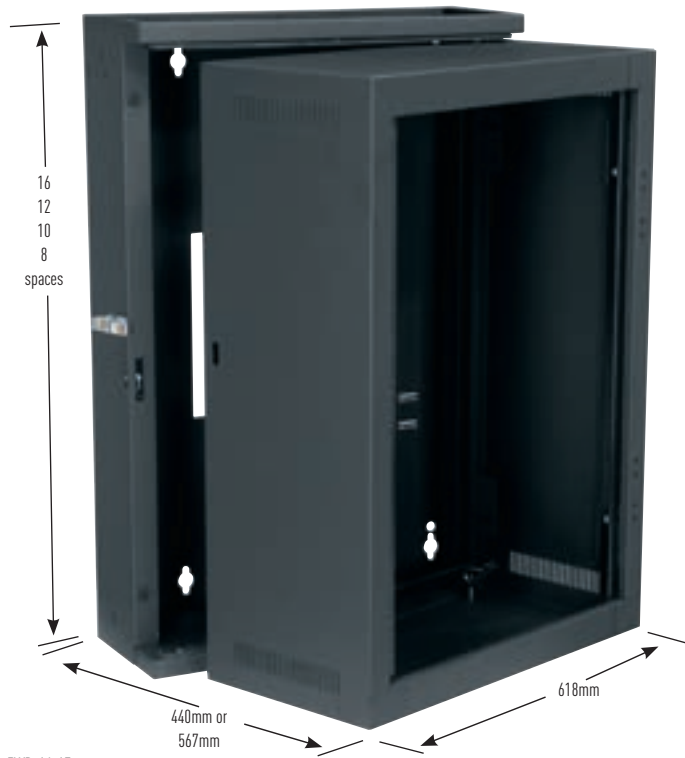

EWR-16-17

- Fully welded construction for strength
- Patented Tool Free Quick-Mount™ system for center section mounting
- Center section swing is reversible, and can be both keylocked and padlocked
- Center section is keyed differently from optional front door for security
- Optimized for passive thermal management

CERTIFICATIONS

- RoHS
- GREENGUARD
- UL2416

MARKET SOLUTIONS



Broadcast



Commercial
AV



Residential
AV



Security



Structured
Cabling



Education

PRODUCT INFORMATION

PART #	FULLY ASSEMBLED WITH SOLID FRONT DOOR PART #	RACKING HEIGHT	OVERALL HEIGHT	USEABLE DEPTH	OVERALL DEPTH	OVERALL WIDTH*	UL LOAD CAPACITY
EWR-10-17	EWR-10-17SD	445mm (10 space)	622mm	381mm	440mm	618mm	90.7 kg
EWR-12-17	EWR-12-17SD	533mm (12 space)	711mm	381mm	440mm	618mm	90.7 kg
EWR-16-17	EWR-16-17SD	711mm (16 space)	889mm	381mm	440mm	618mm	90.7 kg
EWR-16-22	EWR-16-22SD	711mm (16 space)	889mm	508mm	567mm	618mm	90.7 kg



- Accessory Bundles
- Equipped with multipacks of system essentials & available in 3 sizes, see pg. 129

OPTIONS Please visit our website for more info.

FITS PART #	FRONT DOORS				ADDITIONAL 10-32 THREADED RACKRAIL	RACKRAIL BRACKET EXTENDER*
	SOLID	PLEXI	64% OPEN AREA PERF	PARTIALLY VENTED		
EWR-10-17	FD-10	PFD-10	LVFD-10	EVFD-10	DWR-RR10	EWR-ARB-17
EWR-12-17	FD-12	PFD-12	LVFD-12	EVFD-12	DWR-RR12	EWR-ARB-17
EWR-16-17	FD-16	PFD-16	LVFD-16	EVFD-16	DWR-RR16	EWR-ARB-17
EWR-16-22	FD-16	PFD-16	LVFD-16	EVFD-16	DWR-RR16	EWR-ARB-22

*allows fully adjustable rail

SHALLOW PIVOTING VERSATILE WALL CABINET

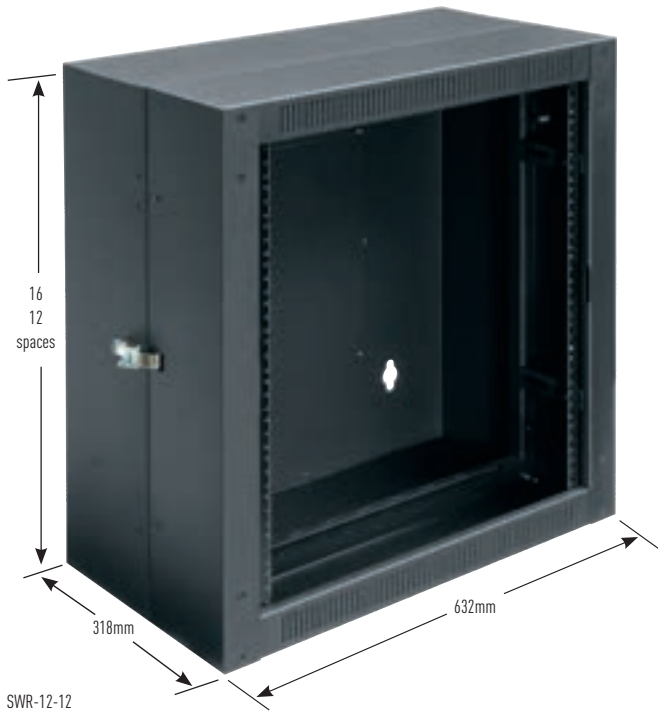

The SWR Series is ideal for wall mounting interconnect panels.

- Front section can be easily reversed for left or right hand swing
- Latch can be mounted top or bottom to allow side-by-side mounting
- Backpan features conduit entry laser knockouts at the top and bottom
- Standard front adjustable 10-32 threaded rackrail with # spaces

Certifications

- RoHS
- GREENGUARD

ECONOMICAL FIXED WALL RACK

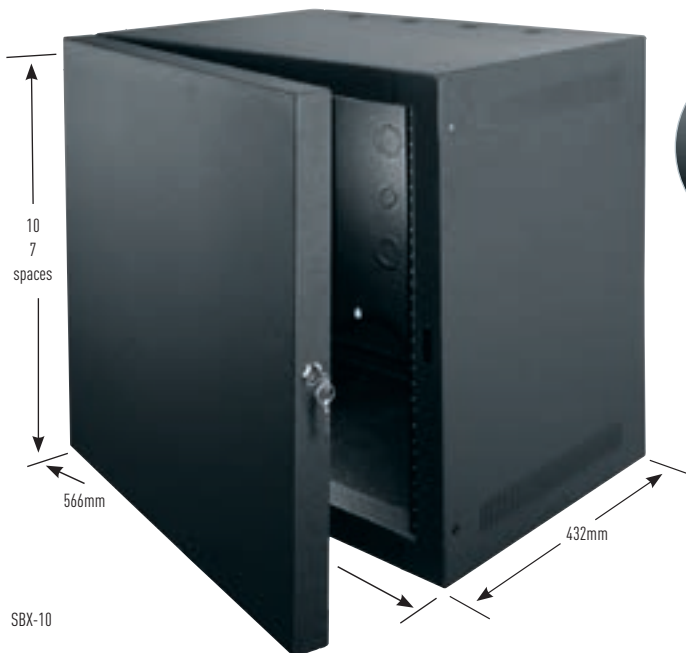

The SBX Series is ideal for use when seeking an economical solution for wall mounting smaller systems.

- Removable backpan simplifies installation
- Includes locking front door that swings open a full 180° on a rugged hinge
- Ventilation slots on each side promote passive thermal management accepts optional fans for active thermal management
- Laser and electrical knockouts at top, bottom, and rear for cable pass-through
- Standard heavy-gauge, 10-32 threaded rackrail with marked spaces

CERTIFICATIONS

- RoHS
- GREENGUARD

PRODUCT INFORMATION

PART #	RACKING HEIGHT	OVERALL HEIGHT	USEABLE DEPTH	OVERALL DEPTH	OVERALL WIDTH	WEIGHT CAPACITY
SWR-16-12	711mm (16 space)	816mm	302mm	318mm	632mm	68 kg

DOOR OPTIONS

SOLID PART #	PLEXI PART #	25% OPEN AREA PERF VENTED PART #	64% OPEN AREA PERF VENTED PART #	# OF RACKSPACES
FD-16	PFD-16	VFD-16	LVFD-16	16

MARKET SOLUTIONS



PRODUCT INFORMATION

PART #	RACKING HEIGHT	USEABLE DEPTH	WEIGHT CAPACITY
SBX-7	311mm (7 space)	375mm	34 kg
SBX-10	445mm (10 space)	375mm	45 kg

MARKET SOLUTIONS





MOST VERTICAL VERSATILITY

LOW-PROFILE WALL CABINET

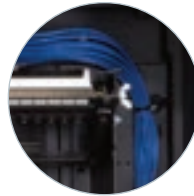

The VWM Series is the industry's highest capacity and most versatile low profile wall cabinet. This patent-pending design features multiple planes of vertical mounting, it allows deeper equipment to be mounted parallel to the wall, and is the first low profile cabinet to offer intuitive mounting for small devices. VWM cabinets are ideal for small to medium networking, surveillance and monitoring, distributed audio and paging systems. Select one of our pre-configured models or tailor a VWM cabinet to order for the specific needs of the application at middleatlantic.com.

- Maximizes space and expertly handles the highest density of components
- Unique design allows mounting of rackrail where it's needed: left, center or right justified and multiple vertical positions
- Choose pivoting or fixed rackrail: with multiple RU options available, all rackrail features both 10-32 thread and cage nut
- Outfit the cabinet's backpan or door with Lever Lock™ to mount small devices
- Available in 10" or 16" depth from the wall (up to 5 or 8RU) and 36 or 42" height along the wall (up to 31" or 37" useable depth)
- Supports thermal management, cable integrity, power distribution and maximizing space while providing a secure location for components of all sizes in an all-in-one system

Certifications

- UL2416
- GREENGUARD
- RoHS compliant

*Additional options including more colors, greater flexibility in door configuration as well as equipment mounting additions available when configuring the VWM in the design tool.

PRE-CONFIGURED MODELS



models that meet your specific application



putty or black color



2-gang electrical box and fixed or pivoting rackrail



full or split doors (top plexi or solid)

PRE-CONFIGURED PART #	DOOR	RACKRAIL INCLUDED	HEIGHT	DEPTH	FINISH
WWM-2-2-36K-PW	Solid	2 pivot RU, 2 fixed RU	915mm	305mm	putty
WWM-4-5-36K-PW	Solid	4 pivot RU, 5 fixed RU	915mm	305mm	putty
WWM-4-5-42K-PW	Solid	4 pivot RU, 5 fixed RU	1067mm	305mm	putty
WWM-SD-4-36K-BW	Split, solid top	4 fixed RU	915mm	305mm	black
WWM-SD-6-36K-BW	Split, solid top	6 fixed RU	915mm	458mm	black
WWM-SD-8-36K-BW	Split, solid top	8 fixed RU	915mm	458mm	black
WWM-PD-4-36K-PW	Split, plexi top	4 fixed RU	915mm	305mm	putty
WWM-PD-6-36K-PW	Split, plexi top	6 fixed RU	915mm	458mm	putty
WWM-PD-8-36K-PW	Split, plexi top	8 fixed RU	915mm	458mm	putty

UNIQUE OPTIONS



fixed and pivoting rackrail

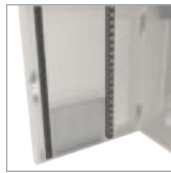

Lever Lock™ back pan & front door kits

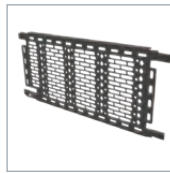

17" vertical Lever Lock™ Accessories



backpan brush grommet

OPTIONS AND ACCESSORIES

	PART #	RAIL TYPE	USEABLE RACKSPACES	MOUNTING CONFIGURATIONS	FITS 10" DEEP VWM	FITS 16" DEEP VWM
RACKRAIL OPTIONS*	WWM-RR-2	fixed	2	horizontal vertical diagonal	X	X
	WWM-RR-4	fixed	4		X	X
	WWM-RR-5	fixed	5		X	X
	WWM-RR-6	fixed	6			X
	WWM-RR-8	fixed	8			X
	WWM-RR-PIV-2	pivoting	2		100°	X
	WWM-RR-PIV-4	pivoting	4	X		X

*all rackrail options feature both 10-32 thread and cage nut

MARKET SOLUTIONS



Broadcast



Commercial AV



Residential AV



Security



Structured Cabling



Education



International Fan Available

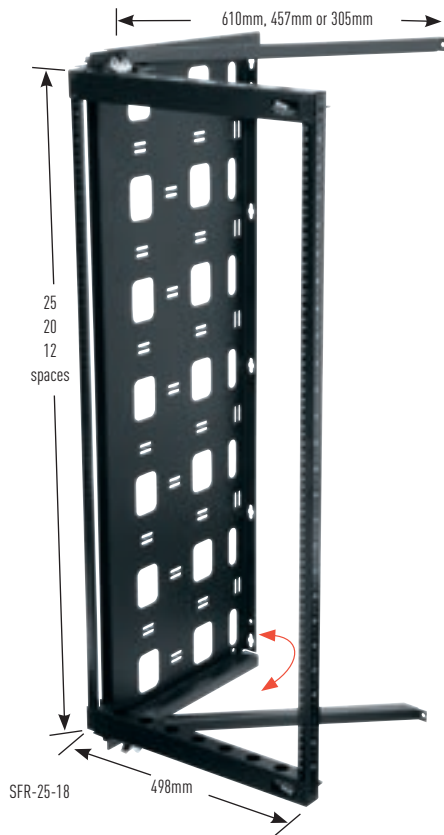

SWING FRAME WALL RACK



The SFR Series is ideal for patch panels, hubs, switches and other network equipment in a secure room or closet.

- Rugged steel construction provides the greatest strength in its class
- Unique design uses pivot points and can be inverted left or right swing
- Open-back design maximizes useable wall space
- 90° opening with positive stop for punching down
- Ready-to-assemble design allows for flat shipment via UPS
- Standard 10-32 threaded rackrail with marked spaces

CERTIFICATIONS

- RoHS
- GREENGUARD

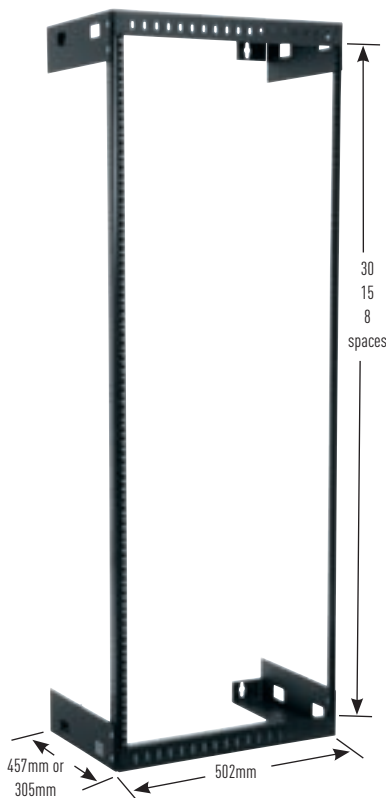

OPEN FRAME WALL MOUNT RACK



The WM Series is designed for quick and easy assembly, self squaring wall mount rack for all types of components.

- Rugged steel construction
- Ready-to-assemble design allows for flat shipment via UPS
- Self-aligning design for fast assembly
- 10-32 threaded rackrail
- Includes rack screws

CERTIFICATIONS

- RoHS
- GREENGUARD

WM-30-12



PRODUCT INFORMATION

305mm Depth Part #	457mm Depth Part #	Racking Height	Overall Height	Weight Capacity
SFR-12-12	SFR-12-18	533mm (12 space)	692mm	45 kg
SFR-20-12	SFR-20-18	889mm (20 space)	1048mm	45 kg
-	SFR-25-18	1111mm (25 space)	1270mm	45 kg



For additional cable management options

- Vertical cable management pg. 214
- Horizontal cable management pg. 210

MARKET SOLUTIONS



PRODUCT INFORMATION

Part #	Overall Height	Racking Height	Depth	Weight Capacity
WM-8-18	451mm	356mm (8 space)	457mm	68 kg
WM-15-18	762mm	667mm (15 space)	457mm	68 kg

MARKET SOLUTIONS





VERTICAL PANEL PANEL MOUNT



The VPM Series is ideal for applications where a protective enclosure is not required.

- Accommodates all depths of equipment
- Heavy duty 10-32 threaded rackrail
- Use two to provide 4-point mounting
- Includes hole for safety screw (for under desk mounting)
- 91 kg weight capacity

VPM-4

CERTIFICATIONS

- RoHS
- GREENGUARD

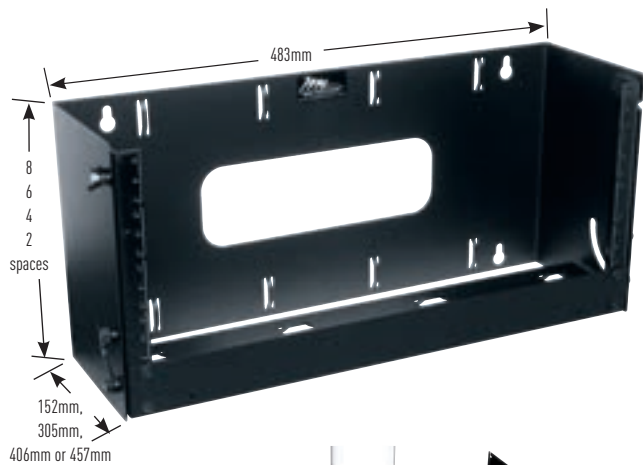

PIVOTING PANEL MOUNT



The PPM Series is designed for rear access of patch panels and network equipment with 90° positive stop drop down.

- Open back design for wall obstructions such as conduits or raceways
- Abundant internal tie points for cable management
- Standard 10-32 threaded rackrail
- Includes hook and loop cable fasteners and rack screws
- Optional security covers and doors available

PPM-4

PPM-6-160B

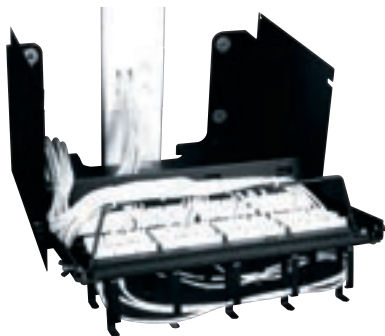

CERTIFICATIONS

- RoHS
- GREENGUARD



PRODUCT INFORMATION

Part #	Racking Height
VPM-2	89mm (2 space)
VPM-3	133mm (3 space)
VPM-4	178mm (4 space)

MARKET SOLUTIONS



PRODUCT INFORMATION

Part #	Backless PPM Part #	Security Top Cover Part #	Security Door Part #	Racking Height	Overall Height	Depth	Weight Capacity
PPM-2	-	-	-	89mm (2 space)	146mm	152mm	9 kg
PPM-4	-	-	-	178mm (4 space)	235mm	152mm	9 kg
PPM-6	-	-	-	267mm (6 space)	324mm	152mm	14 kg
PPM-6-12	-	PPM-LID12	PPM-D06*	267mm (6 space)	324mm	305mm	18 kg
-	PPM-6-160B	PPM-LID16	PPM-D06*	267mm (6 space)	324mm	406mm	18 kg
PPM-8-12	-	PPM-LID12	PPM-D08*	356mm (8 space)	413mm	305mm	27 kg
PPM-8-18	-	PPM-LID18	PPM-D08*	356mm (8 space)	413mm	457mm	27 kg

*When using door option, top cover is required

Additional Options:



PPM-D08
security door



PPM-LID16
lid, fits 406mm deep PPMs

MARKET SOLUTIONS



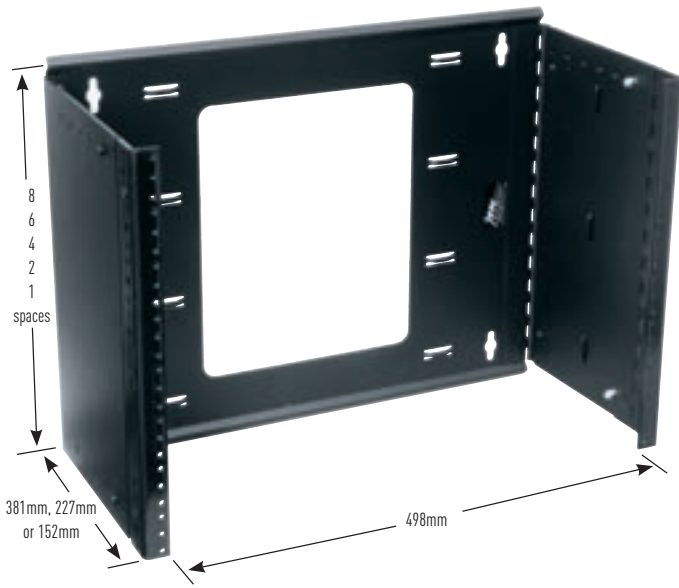

HPM-8-915

HINGED PANEL MOUNT



The HPM Series provides simple wall mounting of components and can be rackmounted to any 483mm open frame rack.

- Rugged steel construction
- Hinged to provide rear access to mounted components
- Universal keyhole mounting for left or right swing
- Standard 10-32 threaded rackrail
- Optional dust cover/modem shelf is available
- Includes rack screws and hook & loop fasteners

CERTIFICATIONS

- RoHS
- GREENGUARD

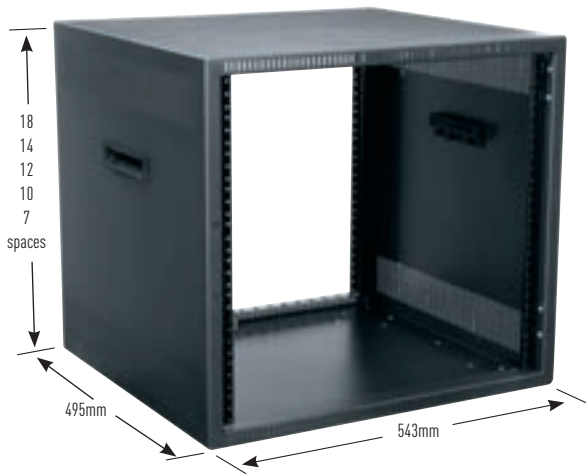

DTRK-1418

DESKTOP RACKS



The DTRK Series racks provides a rackmounting solution for desktop or under-desk applications.



- Ships fully assembled, with sturdy welded steel construction
- Optional brackets provide compatibility with select Lever Lock™ accessories
- Efficient mounting Lever Lock™ system compatible (see pg. 206)
- Standard fixed front and rear 10-32 threaded rackrail

CERTIFICATIONS

- UL
- RoHS
- GREENGUARD

PRODUCT INFORMATION

PART #	RACKING HEIGHT	HINGE TYPE	DEPTH	ADJUSTABLE DEPTH	WEIGHT CAPACITY
HPM-4	178mm (4 space)	single	152mm	-	-
HPM-4-915	178mm (4 space)	double	381mm	229mm - 381mm	7 kg
HPM-6	267mm (6 space)	single	152mm	-	-
HPM-6-915	267mm (6 space)	double	381mm	229mm - 381mm	9 kg
HPM-8-915	356mm (8 space)	double	381mm	229mm - 381mm	11 kg

OPTIONS

Please visit our website for more info.

PART #	RACKING HEIGHT
HPM-LID	top dust cover acts as an equipment shelf for 152mm HPM only

MARKET SOLUTIONS



PRODUCT INFORMATION

PART #	RACKING HEIGHT	OVERALL HEIGHT	USEABLE DEPTH	UL LOAD CAPACITY
DTRK-718	311mm (7 space)	358mm	470mm	136 kg
DTRK-1018	445mm (10 space)	492mm	470mm	136 kg
DTRK-1218	533mm (12 space)	581mm	470mm	136 kg
DTRK-1418	622mm (14 space)	670mm	470mm	136 kg
DTRK-1818	800mm (18 space)	848mm	470mm	136 kg

OPTIONS

Please visit our website for more info.

PART #	VENTED FRONT DOOR	PLEXI/VENTED FRONT DOOR	SOLID REAR ACCESS PANEL W/ BRUSH CABLE ENTRY	LL-DTRK ALLOWS VERTICAL LEVER LOCK* HEIGHT	COMMERCIAL GRADE CASTERS
DTRK-718	DT-VFD-7	DT-PVFD-7	DT-RAP7	-	DTRK-W
DTRK-1018	DT-VFD-10	DT-PVFD-10	DT-RAP10	533mm	DTRK-W
DTRK-1218	DT-VFD-12	DT-PVFD-12	DT-RAP12	533mm	DTRK-W
DTRK-1418	DT-VFD-14	DT-PVFD-14	DT-RAP14	533mm	DTRK-W
DTRK-1818	DT-VFD-18	DT-PVFD-18	DT-RAP18	533mm	DTRK-W

MARKET SOLUTIONS



Additional Options:



Lever Lock* requires optional LL-DTRK kit



Slide Out Racks

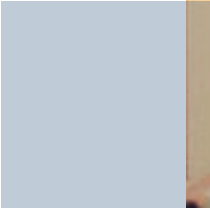

Slide out racks, pioneered by Middle Atlantic Products, solve a common challenge by providing rear access to equipment and connections where a rear open aisle is not possible.

They are ideal for cramped utility spaces, systems built into residential or commercial millwork and small systems in AV furniture.



All styles have robust weight capacities and pull forward to provide rear access; some styles also rotate to further increase accessibility.

WR SERIES	50 - 51
AX-SXR SERIES	52 - 53
SRSR SERIES	56 - 57

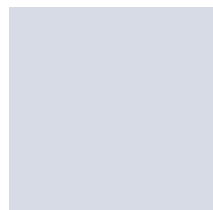

ROLL OUT ROTATING SYSTEM



The WR Series provides secure rear access to equipment connections for larger audio, video and security equipment installations.

- Host enclosure can be pre-installed on-site
- Detachable rack frame can be integrated with equipment and tested off-site
- Requires no additional accessories to roll out and rotate
- Engineered ventilation is optimized for passive thermal management
- Rack frame features built-in cable management tie points
- 102mm laser knockouts provided for cable pass-through and ganging multiple racks
- Standard front and rear 10-32 threaded rackrail with marked spaces
- Frame locks in closed position



CERTIFICATIONS

- UL2416
- RoHS
- GREENGUARD

MARKET SOLUTIONS



Broadcast



Commercial
AV



Residential
AV



Security



Structured
Cabling



Education



International
Fan Available

PRODUCT INFORMATION

PART #	OVERALL DEPTH	USEABLE DEPTH	USEABLE RACKING HEIGHT
WR-24-32	835mm	660mm	1067mm (24 space)
WR-37-32	835mm	660mm	1645mm (37 space)
WR-37-42	1089mm	914mm	1645mm (37 space)
WR-44-32	835mm	660mm	1956mm (44 space)
WR-44-42	1089mm	914mm	1956mm (44 space)

OPTIONS Please visit our website for more info.

FITS PART #	76MM DEEP SOLID FRONT DOOR*	76MM DEEP PLEXI FRONT DOOR*	ADDITIONAL THREADED RACKRAIL	REAR ACCESS PANEL
WR-24-xx	WRFD-24	WRPFD-24	WR-RR-24	WR-RAP-24
WR-37-xx	WRFD-37	WRPFD-37	WR-RR-37	WR-RAP-37
WR-44-xx	WRFD-44	WRPFD-44	WR-RR-44	WR-RAP-44

*Doors provide 76mm clearance from face of front rail. NOTE: When multiple units are installed and doors swing the same way, additional cable chase is required for door opening clearance.

SPACE-SAVING DESIGN

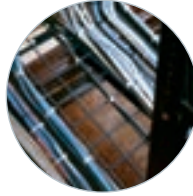

The AXS Series allows the rack frame to pull straight out for rear access to equipment in millwork or in-wall applications.

- Unique interlocking corner joint for exceptional strength and easy assembly
- Removable rack frame can be integrated off-site to save time
- Articulating cable carriers provide effective cable management
- Standard fixed front and rear 10-32 threaded rackrail
- Service stand raises service tracks to bottom of AXS, allowing it to pull out
- Service tracks include built-in level to save time



CERTIFICATIONS

- RoHS
- GREENGUARD

MARKET SOLUTIONS



Broadcast



Commercial AV



Residential AV



Security



Structured Cabling



Education



International Fan Available

PRODUCT INFORMATION

PART #		EXT. LENGTH	FRAME DEPTH	WEIGHT CAPACITY	ROUGH OPENING WIDTH	ROUGH OPENING WIDTH WHEN USING GASKET & GUIDE KIT	ROTATING
AXS-xx-26	xx equals # of useable space (15 to 43 space)	1219mm	660mm	295 kg	489mm	499mm	no
AXS-xx	xx equals # of useable space (15 to 43 space)	1219mm	508mm	295 kg	489mm	499mm	no
AX-SX-xx	xx equals # of useable space (10 to 43 space)	635mm	508mm	295 kg	489mm	499mm	no

SERVICE TRACKS* - PAIR OF REMOVABLE SERVICE TRACKS			
PART #	USE WITH	TRACK LENGTH	RACK FRAME EXT. DEPTH
TRACK25	AX-SX, SSAX	635mm	635mm
TRACK50	AXS, SAX, AXS-xx-26	1270mm	1219mm

SERVICE STANDS* - REMOVABLE TELESCOPING STAND THAT SUPPORTS & LEVELS THE SERVICE TRACKS			
PART #	HEIGHT RANGE OFF THE FLOOR	PART #	HEIGHT RANGE OFF THE FLOOR
TS310	76mm to 125mm	TS1640	406mm to 1016mm



Complete The Look

- RSH custom rackshelves pg.190

OPTIONS Please visit our website for more info.

PART #	DESCRIPTION	FITS
AXS-FAN	1 slim fan, 57 CFM	AX-SXR
AXS-FAN-K	2 slim fans, 114 CFM	AX-SXR
AXS-GG16	gasket and guide kit	406mm deep AXS
AXS-GG20	gasket and guide kit	508mm deep AXS
AXS-GG26	gasket and guide kit	660mm deep AXS
AXS-TEXTRIM	trim panel textured finish	any AXS
AXS-WT50	cable management tray	AXS, SAX
AXS-WT25	cable management tray	AX-SX, SSAX
BG17	5182mm brush gasket	any AXS

Additional Options:

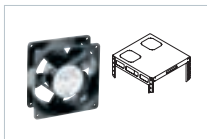

AXS-FAN-119
top accepts up to 2 fans



AXS-TEXTRIM
trim panel



AXS-WT50
cable management tray



AX-SXR

IN-WALL SLIDE OUT ROTATING RACK



The AX-SXR Series pulls out from an in-wall installation, it also turns once pulled out to provide more access to equipment.

- Specify when installing audio and video equipment flush into a wall or cabinet
- Ideal for use in tight spaces with limited room to slide out the rack
- Unique interlocking corner joint for exceptional strength and easy assembly
- Removable rack frame can be integrated off-site to save time
- Standard fixed front and rear 10-32 threaded rackrail with numbered spaces
- Service stand raises service tracks to bottom of AXS, allowing it to pull out
- Service tracks include built-in level to save time

CERTIFICATIONS

- Seismic Certified
- RoHS
- Greenguard

MARKET SOLUTIONS



PRODUCT INFORMATION

PART #		EXT. LENGTH	FRAME DEPTH	WEIGHT CAPACITY	ROUGH OPENING WIDTH	ROUGH OPENING WIDTH WHEN USING GASKET & GUIDE KIT
AX-SXR-xx	xx equals # of useable space (15 to 43 space)	787mm	508mm	204kg	489mm	499mm

SERVICE TRACKS* - PAIR OF REMOVABLE SERVICE TRACKS			
PART #	USE WITH	TRACK LENGTH	RACK FRAME EXT. DEPTH
TRACK31	AX-SXR	787mm	787mm

SERVICE STANDS* - REMOVABLE TELESCOPING STAND THAT SUPPORTS & LEVELS THE SERVICE TRACKS			
PART #	HEIGHT RANGE OFF THE FLOOR	PART #	HEIGHT RANGE OFF THE FLOOR
TS310	76mm to 279mm	TS1640	406mm to 1016mm



Complete The Look

- RSH custom rackselves pg. 190

Options

Please visit our website for more info.

FITS PART #	DESCRIPTION	FITS
AXS-FAN-119	1 slim fan, 1.61 m ² /m	AX-SXR
AXS-FAN-K-119	2 slim fans, 3.2 m ² /m	AX-SXR
AXS-GG20	gasket and guide kit	AX-SXR
AXS-TEXTRIM	trim panel textured finish	any AXS
BG17	5182mm brush gasket	any AXS

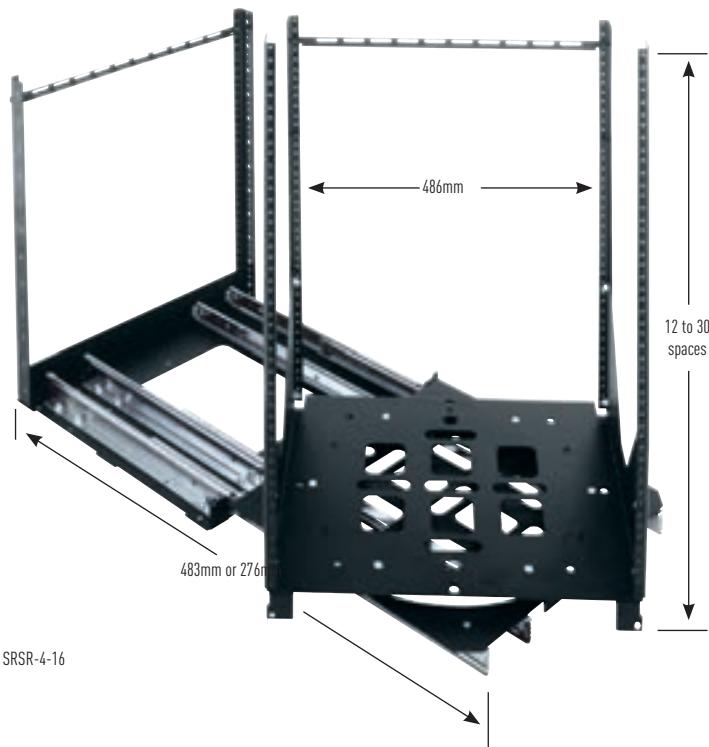

SLIDE OUT ROTATING SHELF



The SRSR Series allows the rack frame to pull out and rotate for rear access to equipment in millwork or in-wall applications.

- Removable rack frame allows in-shop integration and on-site installation of equipment
- Locks in the extended position for simplified equipment integration
- Rotating equipment bay locks in place at 0°, 60° and 90° for easy installation and servicing
- Self-centering mounting base makes it simple to align system within cabinet opening
- Rear cable support works in conjunction with rear rackrail for effective cable management

CERTIFICATIONS

- RoHS
- GREENGUARD

MARKET SOLUTIONS



Broadcast



Commercial
AV



Residential
AV



Security



Structured
Cabling



Education



International
Fan Available

SLIDE OUT RACKS

SRSR SERIES

PART #	DESCRIPTION	OVERALL DEPTH
SRSR-2-xx (# of useable spaces, from 12 to 24)	2 slide 57 kg capacity	483mm
SRSR-4-xx (# of useable spaces, from 12 to 30)	4 slide 113 kg capacity	483mm



Application Tip

- For in cabinet installs, use ICABCOOL to keep system cool, pg. 225

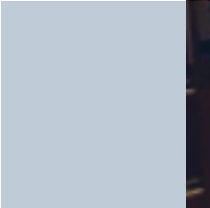

Specialty Racks

Middle Atlantic Products offers a wide range of equipment mounting solutions that were purpose-engineered for special installation challenges, and we call these models "Specialty Application Racks".

This section includes racks designed to roll from room to room, racks designed to fit into AV furniture, and more – even racks designed to hang from the ceiling.



And every solution features the same robust construction and attention to detail that you expect from Middle Atlantic.

We welcome your installation challenges – if you don't find a solution for your installation project needs, please call us for assistance.

MFR AND RFR SERIES	62 - 63
RK/BRK, OBRK AND MBRK SERIES	64 - 65
DR SERIES	66 - 67
PTRK AND CFR SERIES	68 - 69
IRCS SERIES	70 - 71
UNIVERSAL ACCESSORY OPTIONS	72 - 73

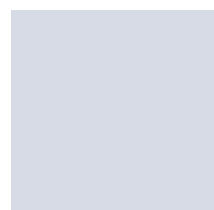



RUGGED AND RELIABLE



The MFR Series racks are engineered and rigorously tested to provide years of trouble-free service, these racks feature premium bolt-through casters and rigid construction for reliability.

- Cost-effective furniture rack
- Bolt-through casters (76mm) and internal steel bracing for strength (102mm casters on 20 space rack)
- Designed for passive cooling; optional fan kit is available
- Includes 10-32 threaded adjustable front rail
- Locking plexi front door is standard
- Ships fully assembled
- Optional flat screen mount holds most monitors up to 813mm

CERTIFICATIONS

- UL
- RoHS
- GREENGUARD



ELEGANT MOBILITY



The RFR Reference Series combines our most elegant design and highest reliability.

- Mobile presentation furniture rack, with wide, stable design
- Bolt-through casters (76mm) and internal steel bracing for strength
- Designed for passive cooling; optional blower kit is available
- Includes 10-32 threaded adjustable front rail
- Ships fully assembled
- Optional flat screen mount holds most monitors up to 813mm
- Efficient mounting Lever Lock™ system compatible (see pg. 206)

CERTIFICATIONS

- UL
- RoHS
- GREENGUARD

PRODUCT INFORMATION

PART #	OVERALL HEIGHT	RACKING HEIGHT	OVERALL DEPTH	USEABLE DEPTH
MFR-1227xx*	679mm	533mm (12 rackspace)	695mm	584mm
MFR-1627xx*	857mm	711mm (16 rackspace)	695mm	584mm
MFR-2027xx*	1067mm	889mm (20 rackspace)	695mm	584mm

* Replace 'xx' with GE = Grained Ebony Ash

OPTIONS

REAR RACKRAIL KITS*	RACKING HEIGHT
MFR-RRK-12	533mm (12 rackspace)
MFR-RRK-16	711mm (16 rackspace)
MFR-RRK-20	889mm (20 rackspace)
* NOTE: you must order rear rail in the same size as your rack order.	

FINISHES Please see pg. 249 for more info.

MARKET SOLUTIONS



PRODUCT INFORMATION

PART #	OVERALL HEIGHT	RACKING HEIGHT	OVERALL DEPTH	USEABLE DEPTH
RFR-1628xx*	889mm	711mm (16 rackspace)	718mm	590mm
RFR-2028xx*	1067mm	889mm (20 rackspace)	718mm	590mm
RFR-2428xx*	1244mm	1067mm (24 rackspace)	718mm	590mm

* Replace 'xx' with BR = Black Rain, CR = Cherry Rain, TR = Teak Rain.

OPTIONS

REAR RACKRAIL KITS*	RACKING HEIGHT	LEVER LOCK™ MOUNTS (2)**
RFR-ERRK-16	711mm (16 rackspace)	LL-RFR
RFR-ERRK-20	889mm (20 rackspace)	
RFR-ERRK-24	1067mm (24 rackspace)	

* NOTE: you must order rear rail in the same size as your rack order. **Accommodates all 432mm vertical Lever Lock options.

FINISHES Please see pg. 49 for more info.

MARKET SOLUTIONS



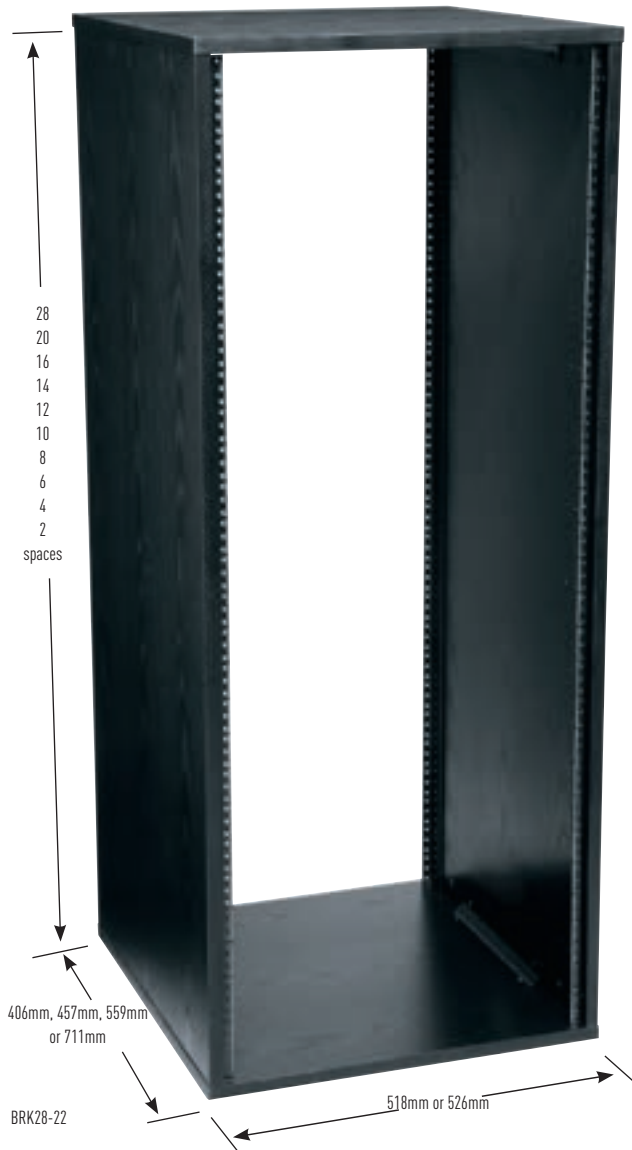

LAMINATE EQUIPMENT RACKS



The RK/BRK Series are versatile equipment racks are offered with a variety of options for superior equipment mounting, casters and aesthetics.

- Superior equipment mounting, mobility and aesthetics
- Ready-to-assemble design allows for flat shipment
- Easy assembled with included hardware
- Includes 10-32 threaded front rackrail
- Available in black, maple or oak laminate finish

CERTIFICATIONS

- RoHS
- GREENGUARD

MARKET SOLUTIONS



Broadcast



Commercial AV



Residential AV



Security



Structured Cabling



Education



International Fan Available



MBRK16



OBRK16

SPECIALTY RACKS

RK/BRK, OBRK AND MBRK SERIES

RACKS AND ENCLOSURES

PRODUCT INFORMATION

	SERIES	PART #	DEPTH	RACKING HEIGHT	OVERALL HEIGHT	WEIGHT CAPACITY
BLACK FINISH	RK	RK2	406mm	89mm (2 space)	127mm	91 kg
		RK4	406mm	178mm (4 space)	216mm	91 kg
		RK6	406mm	267mm (6 space)	305mm	91 kg
		RK8	406mm	356mm (8 space)	394mm	91 kg
		RK10	406mm	445mm (10 space)	483mm	91 kg
		RK12	406mm	533mm (12 space)	572mm	91 kg
		RK14	406mm	2114mm (14 space)	660mm	91 kg
		RK16	406mm	711mm (16 space)	749mm	91 kg
		RK20	406mm	889mm (20 space)	927mm	91 kg
BLACK FINISH	BRK	BRK6	457mm	267mm (6 space)	305mm	91 kg
		BRK8	457mm	356mm (8 space)	394mm	91 kg
		BRK8-22	559mm	356mm (8 space)	394mm	91 kg
		BRK10	457mm	445mm (10 space)	483mm	91 kg
		BRK12	457mm	533mm (12 space)	572mm	91 kg
		BRK12-22	559mm	533mm (12 space)	572mm	91 kg
		BRK12-28	711mm	533mm (12 space)	572mm	91 kg
		BRK14	457mm	2114mm (14 space)	660mm	91 kg
		BRK16	457mm	711mm (16 space)	727mm	91 kg
		BRK16-22	559mm	711mm (16 space)	572mm	91 kg
		BRK16-28	457mm	711mm (16 space)	572mm	91 kg
		BRK20	457mm	889mm (20 space)	927mm	91 kg
		BRK20-22*	559mm	889mm (20 space)	927mm	223 kg
		BRK20-28*	711mm	889mm (20 space)	927mm	91 kg
		BRK28-22*	559mm	4227mm (28 space)	1283mm	223 kg
BRK28-28*	711mm	4227mm (28 space)	1283mm	91 kg		
MAPLE FINISH	MBRK	MBRK8	406mm	356mm (8 space)	394mm	91 kg
		MBRK8-22	559mm	356mm (8 space)	394mm	91 kg
		MBRK12	406mm	533mm (12 space)	572mm	91 kg
		MBRK12-22	559mm	533mm (12 space)	572mm	91 kg
		MBRK12-28	559mm	533mm (12 space)	572mm	91 kg
		MBRK16	406mm	711mm (16 space)	572mm	91 kg
		MBRK16-22	559mm	711mm (16 space)	572mm	91 kg
		MBRK16-28	711mm	711mm (16 space)	572mm	91 kg
		MBRK20	406mm	889mm (20 space)	927mm	91 kg
		MBRK20-22*	559mm	889mm (20 space)	927mm	223 kg
		MBRK20-28*	711mm	889mm (20 space)	927mm	223 kg
		MBRK28-22*	559mm	4227mm (28 space)	1283mm	223 kg
MBRK28-28*	711mm	4227mm (28 space)	1283mm	223 kg		
OAK FINISH	OBRK	OBRK8	457mm	356mm (8 space)	394mm	91 kg
		OBRK12	457mm	533mm (12 space)	572mm	91 kg
		OBRK16	457mm	711mm (16 space)	749mm	91 kg
		OBRK20	457mm	889mm (20 space)	927mm	91 kg

*ships LTL

OPTIONS

Please visit our website for more info.

SMOKED TEMPERED GLASS DOOR	RACKING HEIGHT	FITS	REAR ACCESS PANEL BLACK FINISH	FITS			
RK-GD6	267mm (6 space)	all BRKs, MBRKs and OBRKs	-	all BRKs and MBRKs			
RK-GD8	356mm (8 space)		RK-RAP8				
RK-GD10	445mm (10 space)		-				
RK-GD12	533mm (12 space)		RK-RAP12				
RK-GD14	622mm (14 space)		-				
RK-GD16	711mm (16 space)		RK-RAP16				
RK-GD20	889mm (20 space)		RK-RAP20				
RK-GD28	1245mm (28 space)		RK-RAP28				
FAN KIT WITH ENERGY SAVING THERMOSTATIC CONTROL	FITS	QUICK POSITION SHELF	FITS	REAR RACKRAIL KITS	FITS	CASTER KITS (HARDWARE INCL.)	FITS
DC-FANKIT-4	559mm or deeper BRKs, MBRKs and OBRKs	SH-BRK (1) SH-BRK-3P (3)	457mm deep BRKs, MBRKs and OBRKs	RK-RRx (x=number of rackspaces)	all BRKs, MBRKs and OBRKs	RKW RKW-HD	all BRKs, MBRKs and OBRKs

DESKTOP RAIL RACKS



The DR Series rack quickly and inexpensively organizes desktop processing and test equipment.

- Gently sloped rack face for stability and to facilitate equipment viewing
- Ready-to-assemble design allows for flat shipment
- Standard fixed 10-32 threaded rackrail

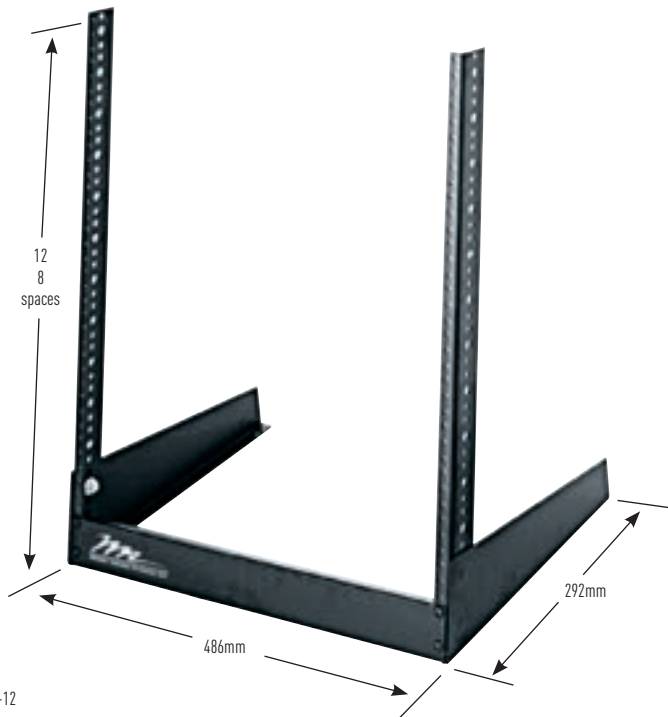

DR-12

CERTIFICATIONS

- RoHS
- GREENGUARD

MARKET SOLUTIONS



Broadcast



Commercial
AV



Residential
AV



Security



Structured
Cabling



Education



International
Fan Available



PRODUCT INFORMATION

PART #	RACKING HEIGHT	OVERALL HEIGHT	WEIGHT CAPACITY
DR-8	356mm (8 space)	408mm	34 kg
DR-12	533mm (12 space)	584mm	34 kg



PORTABLE ROLLING RACKS



The PTRK Series rack is ideal for serving a variety of applications with smooth rolling 102mm casters, advanced cable management and secure doors.

- Fully welded steel construction for strength
- Spring-loaded recessed side handles for rack transport
- Keylocked front and rear doors standard for security
- Side panels are vented for passive thermal management
- Rear door accepts 102mm fans
- Slots in bottom of rack for cable strain relief & security equipment
- Includes heavy-duty commercial grade locking casters

CERTIFICATIONS

- RoHS
- GREENGUARD

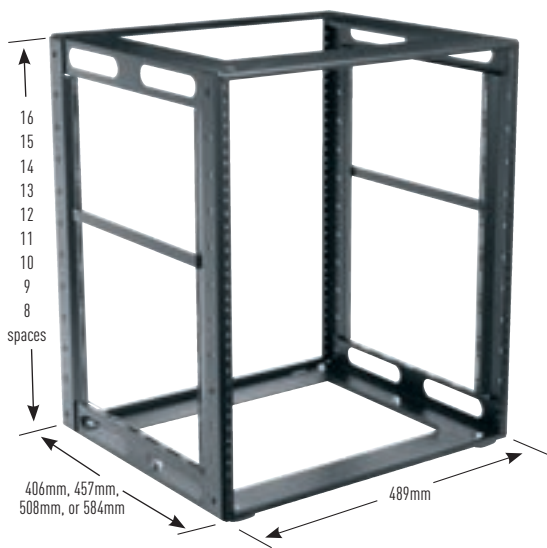

CABINET FRAME RACK



The CFR Series is designed to maximize useable rackspace in entertainment systems, cabinets and similar spaces.

- Low profile design maximizes useable rackspace
- Strong welded frame allows for in-shop integration and on-site installation
- Includes feature offset cable tie areas
- Uprights feature offset cable tie areas
- Taller sizes available, please call for details

CERTIFICATIONS

- UL
- RoHS
- GREENGUARD

PRODUCT INFORMATION

PART #	RACKING HEIGHT	OVERALL HEIGHT INCLUDING CASTERS	USEABLE DEPTH
PTRK-14	622mm (14 space)	857mm	546mm
PTRK-14MDK**	622mm (14 space)	883mm	546mm
PTRK-21	933mm (21 space)	1168mm	546mm
PTRK-21MDK**	933mm (21 space)	1194mm	546mm
PTRK-1426	622mm (14 space)	857mm	622mm
PTRK-1426MDK**	622mm (14 space)	883mm	622mm
PTRK-2126	933mm (21 space)	1168mm	622mm
PTRK-2126MDK**	933mm (21 space)	1194mm	622mm
PTRK-2726	1200mm (27 space)	1435mm	622mm
PTRK-2726MDK**	1200mm (27 space)	1460mm	622mm

**Includes graphite laminate top and plexi front door

MARKET SOLUTIONS



Broadcast



Commercial
AV



Residential
AV



Security



Structured
Cabling



Education



International
Fan Available

PRODUCT INFORMATION

406MM USEABLE DEPTH PART #	457MM USEABLE DEPTH PART #	OVERALL HEIGHT	USEABLE HEIGHT
CFR-8-16	CFR-8-18	379mm	356mm (8 space)
CFR-9-16	CFR-9-18	424mm	400mm (9 space)
CFR-10-16	CFR-10-18	468mm	445mm (10 space)
CFR-11-16	CFR-11-18	513mm	489mm (11 space)
CFR-12-16	CFR-12-18	557mm	533mm (12 space)
CFR-13-16	CFR-13-18	602mm	578mm (13 space)
CFR-14-16	CFR-14-18	646mm	622mm (14 space)

OPTIONS

Please visit our website for more info.

406MM USEABLE DEPTH PART #	457MM USEABLE DEPTH PART #	DESCRIPTION
5-RS16	5-RS18	low friction runner kit (adds 6mm to overall height)

MARKET SOLUTIONS



Broadcast



Commercial
AV



Residential
AV



Security



Structured
Cabling



Education



International
Fan Available



PRE-CONFIGURED RACK SYSTEM

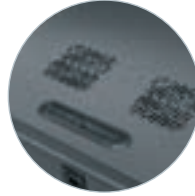

The IRCS Series pre-configured rack system is integration-ready and is fully assembled.

- Assembled with:
 - Glass front door
 - Side and rear access panels
 - Shelves and vent panels
 - Casters and leveling feet
 - Top mounted DC fans
 - Accessory bracket for vertical power strip or lacing strips
- Fully welded, ready-to-integrate design
- Ideal for installation in closets, basements, equipment rooms and other spaces in the rooms
- Attractive design with sleek metallic grey finish
- Quiet, efficient cooling with integrated, 138 CFM DC fans
- Includes accommodations for vertical power strip and thermostatic fan controller (see pg. 227)
- UL Listed, up to 544kg weight capacity

CERTIFICATIONS

- UL Listed
- RoHS
- GREENGUARD

MARKET SOLUTIONS



Broadcast



Commercial
AV



Residential
AV



Security



Structured
Cabling



Education



International
Options



PRODUCT INFORMATION

PART #	PRE-INSTALLED SHELVES	PRE-INSTALLED 2 SPACE BLANK PANELS	UL LOAD CAPACITY	RACKING HEIGHT	OVERALL HEIGHT
IRCS-1824	(3) 2 space, 406mm deep (23kg)	3	227kg	800mm (18 space)	981mm
IRCS-2724	(4) 2 space, 406mm deep (23kg) (1) 2 space, 457mm deep (23kg)	5	340kg	1199mm (27 space)	1381mm
IRCS-3524	(5) 2 space, 406mm deep (23kg) (1) 2 space, 457mm deep (23kg) (1) 3 space, 508mm deep (45kg)	7	454kg	1556mm (35 space)	1737mm
IRCS-4224	(5) 2 space, 406mm deep (23kg) (2) 2 space, 457mm deep (23kg) (2) 3 space, 508mm deep (45kg)	9	544kg	1867mm (42 space)	2048mm



LACE-12-2PK



LB-1A-4PK

CABLE MANAGEMENT

- Vertical lacing strips – perforated with many locations for securing cable bundles
- Horizontal lacer bars – L-shape design with tie points for securing cable bundles

VERTICAL LACING STRIPS PART #	RACKING HEIGHT	WIDTH	TIE POINTS	PRE-PACK QTY
LACE12-2PK	533mm (12 space)	51mm	round holes	2
LACE18-2PK	800mm (18 space)	51mm	round holes	2
LACE21-2PK	927mm (21 space)	51mm	round holes	2
LACE27-2PK	1199mm (27 space)	51mm	round holes	2
LACE35-2PK	1556mm (35 space)	51mm	round holes	2
LACE42-2PK	1867mm (42 space)	51mm	round holes	2

HORIZONTAL LACER BARS PART #	STYLE	PRE-PACK QTY
LB-1A-4PK	"L" bar	4
LB-2A-4PK	"L" bar, 51mm offset	4
LB-4A-4PK	"L" bar, 102mm offset	4



IFANPNL-2DC



IFANTOP-138DC

THERMAL MANAGEMENT

- Fan top attaches to top of QAR/MMR Series racks
 - Use 2 fan tops for up to 276 CFM & easy integration slide into place & tighten
- Fan Panel - traditional rackmount panel
- Fan control unit - runs fans when temperature threshold is crossed
 - Optional for all Essex fan products, includes temperature sensor

PART #	DESCRIPTION	RACKING HEIGHT	# OF FANS	FREE AIR CFM	MAX SOUND LEVEL	VENT BLOCKER
IFANPNL-2DC	fan panel	133mm (3 space)	2 DC	138 CFM	32 dBA	n/a
IFANTOP-138DC	fan top	n/a - fan top	2 DC*	138 CFM	32 dBA	included
FC-DC	thermostatic fan controller, accepts 4 DC fans					

* Two IFANTOP-138DC may be installed on QAR & MMR racks, for total of 4 fans/276 CFM/35 dBA

BUNDLED ACCESSORY PACKAGES

- Ordering made easy
- Bundled accessory packages enable easy ordering of frequently utilized options
- One part # includes the essential accessories which will be needed for an integrated system

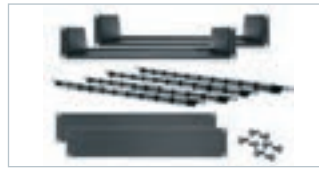

SMALL

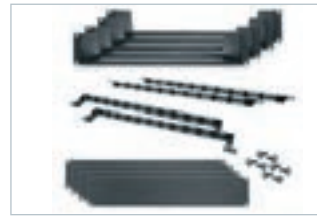

MEDIUM

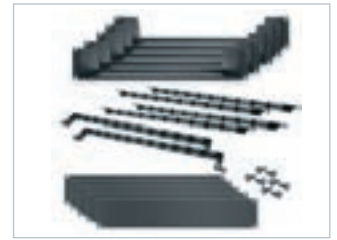

LARGE

Part #	BUNDLE-SMALL	BUNDLE-MEDIUM	BUNDLE-LARGE
Fits Essex Racks	10-18 RU	21-27 RU	35-42 RU
Shelves	(2) 2 RU	(4) 2 RU	(4) 2 RU & (2) 4 RU
Blank Panels	(2) 2 RU	(4) 2 RU	(6) 2 RU
Lacer Bars	(4) straight	(4) straight & (4) 51mm Offset	(8) straight & (4) 51mm Offset
Rack Screws	50	100	200

RACKMOUNT STORAGE AND SHELVES

- 2 & 4 RU drawers with integrator-installed keylock
- 2 & 4 RU vented shelves promote airflow

PART #	RACKING HEIGHT	USEABLE DEPTH	KEYLOCK	REAR CABLE ENTRY	PRE-PACK QTY	WEIGHT CAPACITY
RKDRAWER-2U-LK	89mm (2 space)	368mm	included, not installed	pass-through opening	1	16kg
RKDRAWER-4U-LK	178mm (4 space)	368mm	included, not installed	pass-through opening	1	16kg



RKDRAWER-4U-LK

PART #	RACKING HEIGHT	OVERALL DEPTH	USEABLE DEPTH	PRE-PACK QTY	WEIGHT CAPACITY
RKSHELF-2U-2PK	89mm (2 space)	406mm	402mm	2	23kg
RKSHELF-4U-2PK	178mm (4 space)	432mm	427mm	2	39kg



RKSHELF-2U-2PK

ACCESSORY BRACKET (PAIR)

- Allows for mounting of power, LACE or other vertical options

PART #
ESX-ACC-BKT





Technical Furniture

Technical furniture and mounting systems from Middle Atlantic are built for user ergonomics and system reliability. Just like our racks, they incorporate the best equipment mounting technologies that are:

- Optimized for Audio-Video and Security applications
- Engineered for fast, labor-saving installation



- Innovative solutions, promoting best practices for system reliability
- Designed and manufactured with the highest quality and standards
- The industry's highest customer service levels and quick delivery

Trust your AV installs to the furniture systems built from the rack up and certified for AV – only from Middle Atlantic Products.

C5 SERIES CREDENZAS	76 - 77
C3 SERIES LECTERNS	78 - 79





RACK FOUNDATION WITH A FURNITURE FINISH



Middle Atlantic Products is expanding its C5 Series Credenza offering to address the latest trends in commercial interior design.

- Frame to Furniture™ design complements an integrator's installation workflow
 - Frames are in stock guaranteeing quick delivery while allowing the integrator to immediately start the installation (the custom finishing kit is manufactured to order)
- Attractive styles, finishes and options reflect current design trends
- Frames are in stock guaranteeing quick delivery while allowing the integrator to immediately start the installation
- Built-in high static pressure MAP blower
- Veneer, high-pressure laminate and thermolaminate finishing options
- Available in 1, 2 or 3-bay models with standard or extra depth
- Vent finishes in white, black, silver or off-white
- Door hardware, locks and plexi door options available
- Push-touch latch included

CERTIFICATIONS

- UL Listed
- RoHS
- GREENGUARD

TO ORDER

Build a C5 Series credenza now. Go to our step-by-step guide online www.middleatlantic.com

OVER 100,000 WAYS TO CUSTOMIZE
+ MILLWORK KITS AVAILABLE
+ COLOR MATCH VENEER OPTION

POPULAR FINISHES

Veneer Options – Wood Grain



HPL Options – Wood Grain



Thermolaminate Options

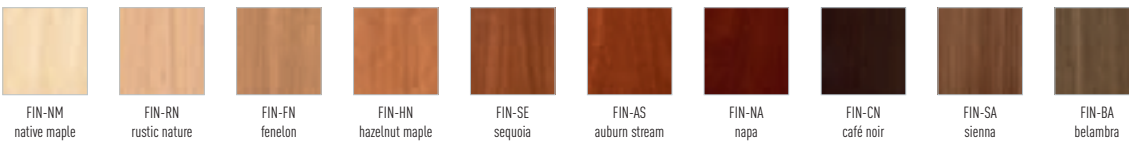

For EMEA availability C5 finishes & options please contact EMEA customer care av.emea.middleatlantic.support@legrand.com

Door Accents



Locks

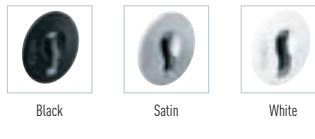

Vents



Doors





ADA COMPLIANT WALL MOUNT DESIGN

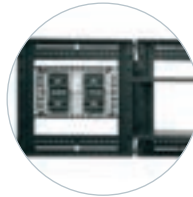

ADA compliant wall mount design
optimized for smaller AV systems

- Frame to Furniture™ design complements an integrator's installation workflow
- Fully assembled frames ship with furniture-grade wood panels
- Flexible equipment mounting storage options from vertical slide out racks and stationary rack unites removable Lever Lock™ Small device mounting system and shelving options
- Wall Mounted ADA compliant design
- Available in 1, 2 and 4 bay models and two heights
- Available in Moderno style
- Standard finishes available: High Pressure Laminate and Thermolaminate materials

FEATURES

Fast delivery of pre configured options.

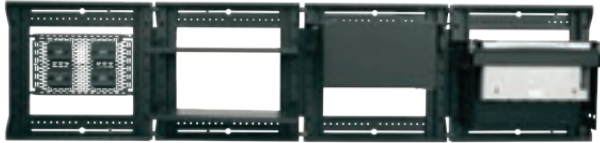

New metal contrasting doors for a modern look



Frame to furniture allows the integrator
to load the gear without waiting for the woodkit



For EMEA availability C5 finishes & options please contact EMEA customer care av.emea.middleatlantic.support@legrand.com



Power products

Systems require reliable, accessible, safe power distribution. Our power solutions are engineered and designed to U.S. standards to specifically meet the needs of a broad range of applications including commercial, residential, security and more.



For international customization, certification, or availability please contact export@middleatlantic.com.

DC POWER

82 - 83

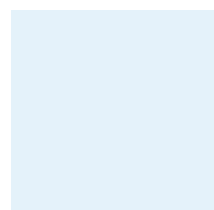



HIGHEST AVAILABLE POWER

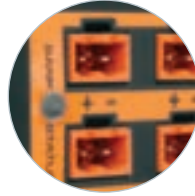

Design on reliability with the universal DC power solution equipped with the highest available power in the market—complete with superior current capacity and an industry-leading quantity of outputs!



- Industry-leading number of outputs with power distributed to as many as 24 devices
- Maximum current capacity, up to 300W of power
 - 5V, 40A Max (200W)
 - 12V, 25A Max (300W)
 - 24V, 12.5A Max (300W)
 - 12V and 24V, 12.5A and 6.25A respectively (300W)
- Reliable multi-level protection on both AC input and DC outputs to ensure maximum uptime
 - MOV surge and overload protection on the AC input
 - Individual redundancy built in with auto-resetting PTC overload protection on each individual output
- Greater mounting flexibility with multi-mount design that fits in 1 rackspace or can mount at the back or side of the rack simply by rotating mounting brackets
- LED indicator lights alerting maximum capacity on each voltage bank
- Leads trimmed to suitable length leaves less cable to manage, enhancing aesthetics and increasing airflow
- Ultra-quiet, thermostatic temperature controlled fan with automatic speed adjustment

CONNECT UP TO 24 DEVICES!



300 WATTS OF POWER!

PRODUCT INFORMATION

PART #	DESCRIPTION	OUTPUTS	WATT MAX OUTPUT
PD-DC-200-5V	maximum power, 200W DC power distribution	5V	200
PD-DC-300-12V	maximum power, 300W DC power distribution with 12V outputs	12V	300
PD-DC-300-24V	maximum power, 300W DC power distribution with 24V outputs	24V	300
PD-DC-300-12-24V	maximum power, 300W DC power distribution with split-bank	12V and 24V	300

To order your regional power version add the below suffix behind the part code

- UK plug
- EU Schuko plug
- CH Swiss plug
- IEC C13 universal cord

PD-DC-300-12V-UK = PD-DC-300-12V + UK power cord cable

ACCESSORIES

CUSTOM RACKSHELVES



RSH SERIES CUSTOM RACKSHELVES

Custom Rackshelves from Middle Atlantic are the first choice of professional installers for mounting and trimming non-rackmount components. With these innovative shelves virtually any component can be installed in a standard 483mm enclosure without modification. The result is a neatly-trimmed installation with a perfect fit and no gaps because the shelf is sized for the selected component and the face plate is custom cut to provide a perfect opening.

- Assembles easily in minutes
- Includes rear brackets to keep components from sliding backward
- Fully ventilated ears and bottom
- Choice of durable powder coat, brushed or anodized finishes
- Depths are automatically provided in 292mm, 356mm, 394mm, 445mm, or 521mm styles based on dimensions of your component
- Accepts any component up to 450mm wide
- Perfect fit both looks great and promotes proper thermal management
- Individual custom faces (less rack ears and shelf bottom) are also available

*Note: Custom faces do not work with standard shelves



ADVANCED IN DESIGN

RSH Series Custom Rackshelves in single-rackspace size feature an advanced design unlike any other custom rackmount product.

- The industry's shortest custom rackmount, occupying only a single rackspace
- Unique 'face-after' design allows for easy installation and switch-out of components
- Tool-free shelf assembly in seconds

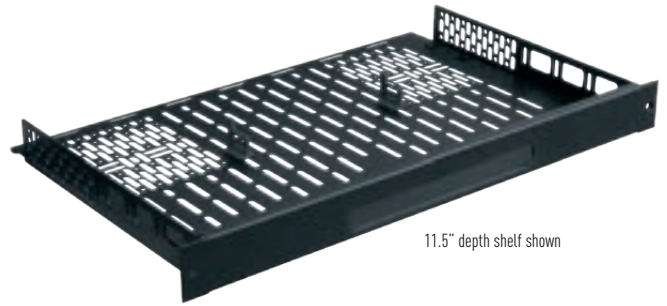

11.5" depth shelf shown



Any RSH face can be cut to accommodate multiple components.
8" depth 1 RU model shown

ADJUSTABLE AND SLIDING RACKSHELVES

Middle Atlantic Products offers a wide range of adjustable and sliding shelves to support your project needs. Most models in this section are designed for 4-point mounting and are adjustable to fit a range of rack sizes. Note that unlike lower-quality offerings, Middle Atlantic shelves in this section include heavy-duty models designed with weight capacities up to 91kg for sliding models and 181kg for fixed models.



SLIDING SHELF

Sliding shelves allow for easy maintenance of your components right on the shelf, and access to connections and cabling from the front of the rack. Middle Atlantic offers several styles of sliding shelves, including low profile, standard and heavy-duty to meet project needs and budgets.

- Adjustable 4-point mounting to fit in many rack models
- SS and SSHD-28 models include cable tie points at rear of shelf

PART #	RACKING HEIGHT	SHELF AREA	MATERIAL	BASE	REAR EAR ADJUSTABLE RANGE	SHELF EXTENSION	WEIGHT CAPACITY
SS	36mm (less than 1space)	445mm w x 375mm d	black powder coat, steel	solid	403mm – 595mm	356mm	23kg
SSL	36mm (less than 1space)	425mm w x 356mm d	black laminate	solid	403mm – 595mm	289mm	16kg

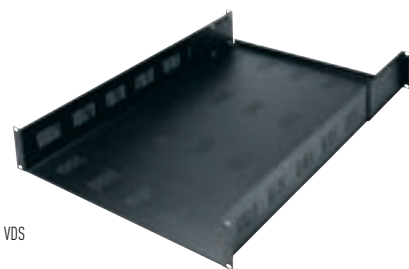

ADJUSTABLE RACKSHELF

These vented 4-point mounting shelves were designed specifically for heavy equipment and adjust to allow 4-point mounting in many available rack depths.

- Partially vented bottoms to allow some cooling airflow
- Weight capacity up to 136kg, depending on model
- Steel construction with durable powder coat finish

PART #	RACKING HEIGHT	SHELF AREA	WEIGHT CAPACITY
VDS	89mm (2 rackspace)	441mm w x 648mm d	45kg

TELESCOPING HEAVY-DUTY RACKSHELF

Unlike standard adjustable shelves, the entire VSA Series shelf telescopes to reach rear rail.

- 4-point mounting for a high 181kg weight capacity
- Fully vented bottoms with cable management tie points
- Steel construction with durable powder coat finish



PART #	RACKING HEIGHT	OVERALL DEPTH	WEIGHT CAPACITY
VSA-1626	38mm (less than 1 rackspace)	438mm w x 406mm (min.) to 660mm (max) d	181kg

RACKSHELVES

Middle Atlantic Products offers a wide range of adjustable and sliding shelves to support your project needs. Note that unlike lower-quality offerings, Middle Atlantic shelves in this section include heavy-duty models designed with weight capacities up to 91kg for sliding models and 181kg for fixed models.

- Choice of solid bottom and fully vented shelves
- Choice of ready-to-use and ready-to-assemble models
- Choice of models that accept optional clamps, or have clamps included
- Some popular models are available in Contractor packs
- All types are finished in a durable black powder coat



U1



U2V



U317



Contractor Pack sample

UTILITY SHELVES

Utility shelves are a workhorse of installation, able to hold a wide range of equipment needed in the rack. Some models are also available in Contractor packs to save space and reduce packaging waste.

- Choice of solid bottom and fully vented shelves
- Choice of ready-to-use and ready-to-assemble models
- Choice of models that accept optional clamps, or have clamps included
- Some popular models are available in Contractor packs
- All types are finished in a durable black powder coat

SOLID PART #	VENTED PART #	RACKING HEIGHT	OVERALL DEPTH	USEABLE DEPTH	WEIGHT CAPACITY
U1	U1V	44mm (1 rackspace)	273mm	256mm	16kg
U2	U2V	89mm (2 rackspace)	370mm	365mm	23kg
U3	U3V	133mm (3 rackspace)	370mm	365mm	32kg
	U317*	133mm (3 rackspace)	370mm	365mm	32kg
U4	U4V	178mm (4 rackspace)	394mm	389mm	39kg

*partially vented, see image

CONTRACTOR AND MASTER PACKS

Contractor/master packs make storage and selection easy.

PART #	TYPE	PACK	RACKING HEIGHT	QTY
U1-RP12	solid	contractor	44mm (1 rackspace)	12
U2-RP6	solid	contractor	89mm (2 rackspace)	6
U1MP	solid	master	44mm (1 rackspace)	50
U2MP	solid	master	89mm (2 rackspace)	50
U3MP	solid	master	133mm (3 rackspace)	36
U1V-4	vented	contractor	44mm (1 rackspace)	4
U2V-4	vented	contractor	89mm (2 rackspace)	4
U3V-4	vented	contractor	133mm (3 rackspace)	4
U4V-4	vented	contractor	178mm (4 rackspace)	4

CLAMPING RACKSHELVES

Clamping shelves captivate components with rubber-lined clamps from the top and adjustable rear brackets.

- Vented bottom
- UL Listed

PART #	TYPE	RACKING HEIGHT	CLAMP HEIGHT RANGE	WEIGHT CAPACITY
CAP5	all ready-to-assemble	222mm (5 rackspace)	162mm - 206mm	45kg
CAP6	all ready-to-assemble	267mm (6 rackspace)	203mm - 251mm	45kg
CAP7	all ready-to-assemble	311mm (7 rackspace)	248mm - 295mm	45kg
CAP8	all ready-to-assemble	356mm (8 rackspace)	292mm - 340mm	45kg
RC-2	all assembled	89mm (2 rackspace)	25mm - 70mm	23kg
RC-3	all assembled	133mm (3 rackspace)	70mm - 117mm	32kg
RC-4	all assembled	178mm (4 rackspace)	114mm - 162mm	39kg



CAP6



OCAP-2



VRS

SAT-CABLE BOX RACKSHELVES

These unique shelves use minimal shelf structure to provide the maximum open area around the supported component – ideal for high-heat components such as satellite and cable boxes. Perfect for installations with multiple video sources such as sports bars, gyms, and hotels.

- Universal fit accommodates most popular cable and satellite box sizes
- Sturdy steel construction with durable black powder coat finish
- OCAP Series: rubber-lined clamps on top and bottom
- VRS Series: holds up to 6 boxes vertically, eliminates need for individual shelves

PART #	EQUIPMENT ORIENTATION	RACKING HEIGHT	DEPTH	WEIGHT CAPACITY	USEABLE HEIGHT
OCAP-2	horizontal	89mm (2 rackspace)	356mm	11kg	67mm
OCAP-3	horizontal	133mm (3 rackspace)	356mm	11kg	111mm
VRS	vertical	89mm (2 rackspace)	381mm	16kg	

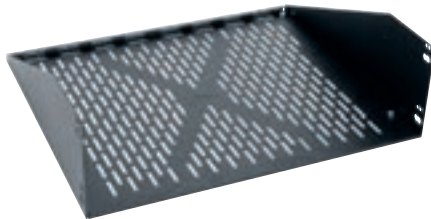

WUSS

WIDE UNIT SHELF SYSTEM

Some components are too wide to fit the 441mm inside width of standard rackshelves. These shelf systems adjust to hold units up to 572mm wide.

- Fully vented bottom aids equipment cooling
- Steel construction with durable powder coat finish
- Saves room by requiring no rackspace
- UL Listed

PART #	USEABLE SHELF AREA	WEIGHT CAPACITY
WUSS14*	441mm (min.) to 575mm w x 356mm d	23kg

*Available in 356mm depth - fits DWR Series and other shallow racks! NOTE: this rackshelf works with all Middle Atlantic enclosures except those that use 'Z-Rail.'

SMALL DEVICE MOUNTING SHELVES

These innovative shelves are designed to mount multiple small devices while providing cable management and tie down points.

- Fully vented bottoms with flexible device mounting patterns
- Steel construction with durable powder coat finish



MS Series

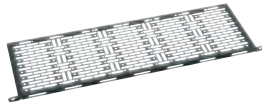

- Holds small items in front or rear of rack



UFA Series



- Available faceplate that easily mounts after install to conceal devices



UMS Series



- Patented design includes counter sunk holes to match popular Extron® devices up to 483mm
- Available in half rack size



UTR Series



- Includes hook and loop strips for component mounting

SERIES	PART #	TYPE	RACKING HEIGHT	DIMENSIONS	WEIGHT CAPACITY	FINISH	PRE-PACK QTY	INCLUDED PANEL	CONTRACTOR/MASTER PACK
MS	MS-11	shelf		13mm h x 445m w x 280mm d	7kg	black powder coat	1		
	MS-11-4	shelf		13mm h x 445m w x 280mm d	7kg	black powder coat	4		
	MS-5.5	shelf		13mm h x 445m w x 140mm d	14kg	black powder coat	1		
	MS-5.5-4	shelf		13mm h x 445m w x 140mm d	14kg	black powder coat	4		
UFA	UFA-8	shelf	44mm (1 rackspace)	438mm w x 203mm d	16kg	black powder coat	1		
	UFA-8-4	shelf	44mm (1 rackspace)	438mm w x 203mm d	16kg	black powder coat	4		
	UFA-14.5	shelf	44mm (1 rackspace)	438mm w x 368mm d	11kg	black powder coat	1		
	UFA-14.5-4	shelf	44mm (1 rackspace)	438mm w x 368mm d	11kg	black powder coat	4		
	UFA-8-F1	shelf	44mm (1 rackspace)	438mm w x 203mm d	16kg	black powder coat	1	1 space	
	UFA-8-F2	shelf	89mm (2 rackspace)	438mm w x 203mm d	16kg	black powder coat	1	2 space	
	UFAF-1	panel	44mm (1 rackspace)			black powder coat	1		
	UFAF-1A	panel	44mm (1 rackspace)			black brushed and anodized	1		
	UFAF-2	panel	89mm (2 rackspace)			black powder coat	1		
	UFAF-2A	panel	89mm (2 rackspace)			black brushed and anodized	1		
	UFAF-3	panel	133mm (3 rackspace)			black powder coat	1		
	UFAF-3A	panel	133mm (3 rackspace)			black brushed and anodized	1		
	UFAF-4	panel	178mm (4 rackspace)			black powder coat	1		
	UFAF-4A	panel	178mm (4 rackspace)			black brushed and anodized	1		
UMS	HR-UMS1-11.5	half rack shelf	44mm (1 rackspace)	254mm w x 292mm d		black powder coat			
	HR-UMS1-3.5	half rack shelf	44mm (1 rackspace)	254mm w x 89mm d		black powder coat			
	HR-UMS1-5.5	half rack shelf	44mm (1 rackspace)	254mm w x 140mm d		black powder coat			
	UMS1-11.5	panel	44mm (1 rackspace)	448mm w x 292mm d	11kg	black powder coat			
	UMS1-11.5K	panel	44mm (1 rackspace)	448mm w x 292mm d	11kg	black powder coat		4 partial blank panels (1/4 & 1/2 width & 1/8 height) & hardware	
	UMS1-3.5	panel	44mm (1 rackspace)	448mm w x 89mm d	11kg	black powder coat			
	UMS1-3.5K	panel	44mm (1 rackspace)	448mm w x 89mm d	11kg	black powder coat		4 partial blank panels (1/4 & 1/2 width & 1/8 height) & hardware	
	UMS1-5.5	panel	44mm (1 rackspace)	448mm w x 140mm d	11kg	black powder coat			
	UMS1-5.5K	panel	44mm (1 rackspace)	448mm w x 140mm d	11kg	black powder coat		4 partial blank panels (1/4 & 1/2 width & 1/8 height) & hardware	
	UMSFP1-1/2	filter blank panel		42mm x 221mm		black powder coat			
	UMSFP1-1/4	filter blank panel		42mm x 110mm		black powder coat			
UMSFP1-1/8	filter blank panel		17mm x 110mm		black powder coat				
UTR	UTR1	shelf	44mm (1 rackspace)	254mm	11kg	black powder coat	50		UTR1MP
							12		UTR1-RP12

ACCESSORIES

KEYBOARD SHELF AND SUPPORT BRACKETS



RM-KB

RACKMOUNT COMPUTER KEYBOARD SHELF

Rackmount computer keyboard systems occupy only 1 rackspace and include articulating arm to provide effective cable management. Finished in a durable black powder coat.

- The RM-KB include a high quality full 101 key AT style keyboard with touchpad and padded wrist-rest

PART #	DESCRIPTION	RACKING HEIGHT	REAR ADJUSTABLE RANGE
RM-KB	rackmount computer keyboard	44mm (1 rackspace)	432mm – 635mm



CSA typical usage

CHASSIS SUPPORT BRACKETS

Chassis support brackets are a simple way to support heavy equipment within the rack and facilitates ventilation of high heat-generating equipment.

- Holds equipment without attaching the rack screws – ideal for fast swap outs
- Compatible with MRK, VRK, and VMRK when used with Z-rail or Z-rail adapter

PART #	OVERALL DEPTH	PRE-PACK QTY	WEIGHT CAPACITY
CSA-18	257mm	2	45kg
CSA-22	559mm	2	45kg
CSA-22-H	559mm	2	91kg
CSA-26	660mm	2	45kg
CSA-26-H	660mm	2	91kg

NOTE: designed for mounting to Z-Rail or to a Z-Rail adapter - not compatible with standard L-shaped rackrail without hardware or rackrail adjustments

WALL MOUNT SHELF

Wall mounting non-rackmount components is much easier with our WMS wall mount shelf. Furniture version features attractive wooden side panels with rounded outside corners for safety.

- Vented bottoms
- Metal parts have durable powder coat finish

PART #	FINISH	WEIGHT CAPACITY
WMS-20	Black (steel)	91kg

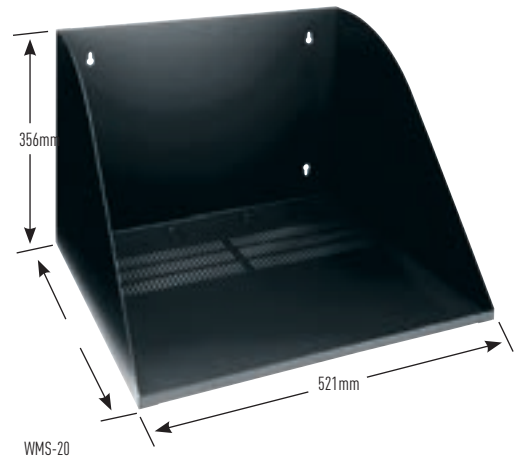

RACKMOUNT STORAGE

Middle Atlantic offers a broad selection of utility and special-purpose storage products to support your project needs. Many installers find that storing documents, manuals, or tools at the installation site increases efficiency and service speed. Models in this section include standard and heavy-duty drawers and lockboxes, as well as inserts for storing media and protecting sensitive contents.

UNIVERSAL MOUNTING DRAWERS

The universal mounting drawer was designed with our patented pattern to mount small devices traditionally located outside the rack to the bottom of the drawer.



D2-UMS-28



D2-UMS-28

articulating cable arm keeps wires from getting pinched when the drawer is pulled open or closed shut

- Smaller components typically mounted to the wall can now be mounted securely within the rack
- Bottom of drawer can be removed before installation to mount small devices and can be screwed into place
- Articulating cable arm keeps wires from getting pinched
- Pattern of holes and slots accommodates nearly any mounting hole pattern, and can also be used for wire tie or other cable fastening methods
- Provides abundant cable management and device tie down points
- Drawer locks for added security
- 4-point mounting for added strength
- Black powder coat finish

PART #	USEABLE MOUNTING AREA	RACKING HEIGHT	WEIGHT CAPACITY
D2-UMS-28	330mm w x 533mm d	89mm (2 space)	20kg

HEAVY DUTY DRAWERS

These drawers have a fully enclosed top and generous inside dimensions measuring 403mm wide by 368mm deep. 2, 3 and 4 space models include drawer mat and rear cable grommet.



D2



D4

- Spring-loaded latches; installed keylock option available
- Steel construction with a 23kg weight capacity
- Choice of black textured or brushed and anodized face finish
- TD8FLK model includes file hanging kit
- UL Listed

BLACK ANODIZED PART #	BLACK ANODIZED PART # W/ LOCK	RACKING HEIGHT
D2	D2LK	89mm (2 rackspace)
D3	D3LK	133mm (3 rackspace)
D4	D4LK	178mm (4 space)

*does not include drawer mat

ECONOMY UTILITY DRAWERS

The UD Series drawers offer an economical rack storage solution. Full extension ball bearing slides extend a full 356mm to reveal inside dimensions measuring 403mm wide by 368mm deep.

- Face formed drawer pulls; user-installed latch & keylock options
- Black powder coat finish
- Steel construction with 23kg weight capacity
- UL Listed

PART #	RACKING HEIGHT
UD1*	44mm (1 rackspace)
UD2	89mm (2 rackspace)
UD3	133mm (3 rackspace)
UD4	178mm (4 space)

* NOTE: UD1 does not accommodate a lock



UD2



UD4

LOCKBOXES

Safely secure gear in a rackmount LBX Series lockbox. 432mm interior width.

- Steel construction with 23kg weight capacity
- UL Listed

PART #	RACKING HEIGHT	OVERALL DEPTH
LBX-3	133mm (3 space)	229mm



LBX-3

ADDITIONAL ACCESSORIES FOR DRAWERS

LATCH



- User-installed UD latch

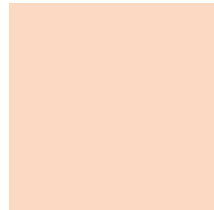

Lever Lock™

Finally! A place to mount non-rackmount and small devices without sacrificing rackspace. Lever Lock™ is a unique and patented system that allows integrators to maximize space in a rack by mounting small devices in the “no man’s land” area between the rackrail and the side panel or rear. Also great for routing cables!

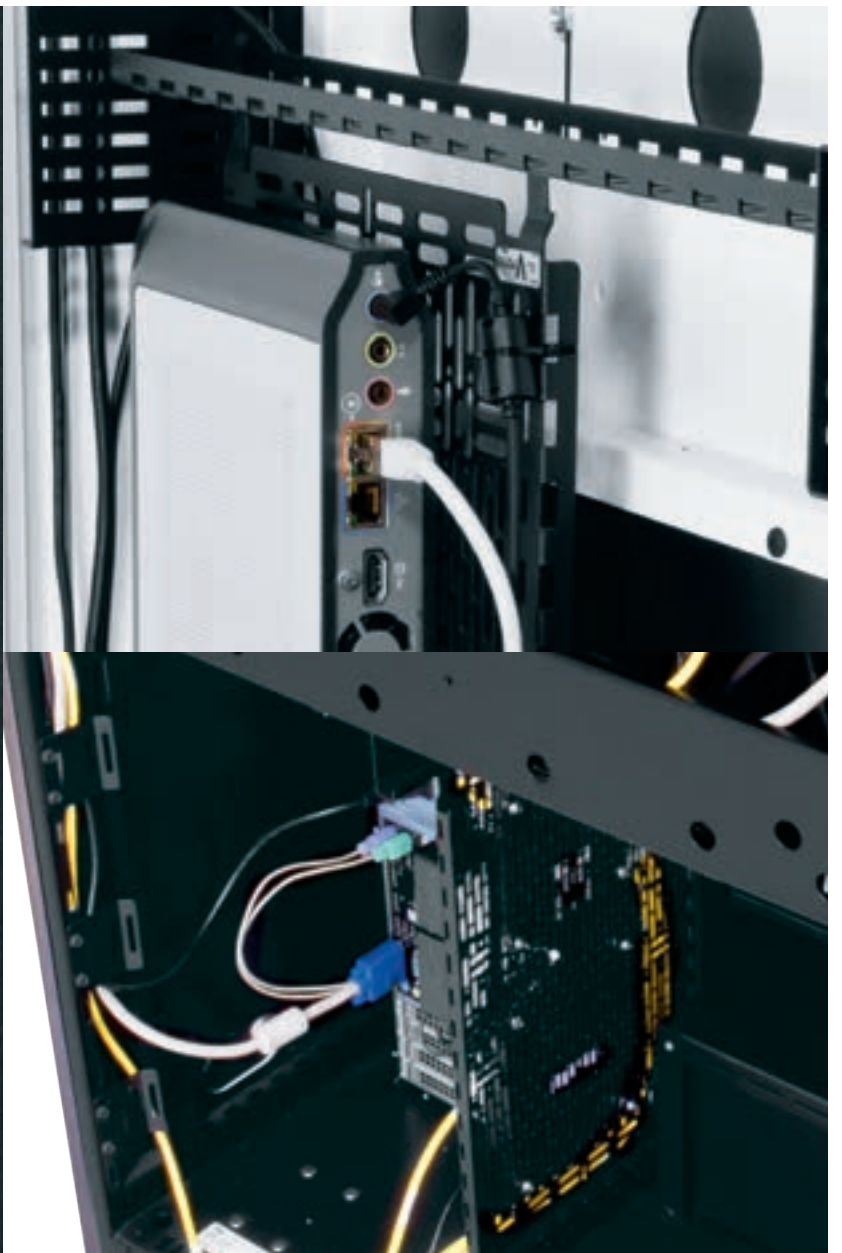

This tool-free system is comprised of plates and bars that can mount vertically and horizontally to accommodate virtually any system. To date- over 14 product families accept Lever Lock and Middle Atlantic continues to add products each year.

Just look for the "Lever Lock™ Ready" badge throughout the catalog or reference the chart on the following page.

LEVER LOCK™

100-101



INTERNAL MANAGEMENT SYSTEM

The patent-pending Lever Lock™ internal management system maximizes space utilization within a rack or furniture. Uniquely designed to facilitate Lever Lock™ cable management and device mounting within the rack through the use of unique tool-free bars and accessory mounting plates.

- Maximizes space within a rack or furniture system
- Universal mounting pattern accommodates most small devices
- Locks in place without tools in Lever Lock™ compatible products (see chart below)
- Offered in a variety of sizes for vertical and horizontal mounting

PART #	4 PACK PART #	DESCRIPTION
LL-H2A21		559mm long horizontal 51mm off-set angle
LL-H4A21		559mm long horizontal 102mm off-set angle
LL-HA21	LL-HA21-4	559mm long horizontal angle
LL-HC21	LL-HC21-4	559mm long horizontal channel
LL-HR21	LL-HR21-4	559mm long horizontal round
LL-VA17	LL-VA17-4	345mm long vertical angle
LL-VA21	LL-VA21-4	432mm long vertical angle
LL-VC17	LL-VC17-4	345mm long vertical channel
LL-VC21	LL-VC21-4	432mm long vertical channel
LL-VDIN17	LL-VDIN17-4	345mm long vertical DIN rail
LL-VDIN21	LL-VDIN21-4	432mm long vertical DIN rail
LL-VP1710		345mm long vertical 254mm deep plate
LL-VP2110		432mm long vertical 254mm deep plate
LL-MP21		7 piece multipack includes (2) LL-VC21, (4) LL-HA21, and (1) LL-VP2110
LL-VP176-SWP		432mm high 152mm Deep, vertical accessory mounting plate plus structured wiring pattern

PRODUCTS ACCEPTING LEVER LOCK™	PG.
BGR Series Racks	12
WWM Series Wall Racks	40
RFR Series Racks	96
DTRK Series Racks	110
C3 Series Lecterns	136

Look for the Lever Lock™ ready badge in the rack and furniture sections for compatible products.

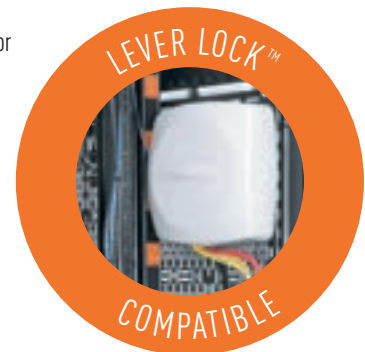

use vertical channels or angles to lace cable bundles from top to bottom

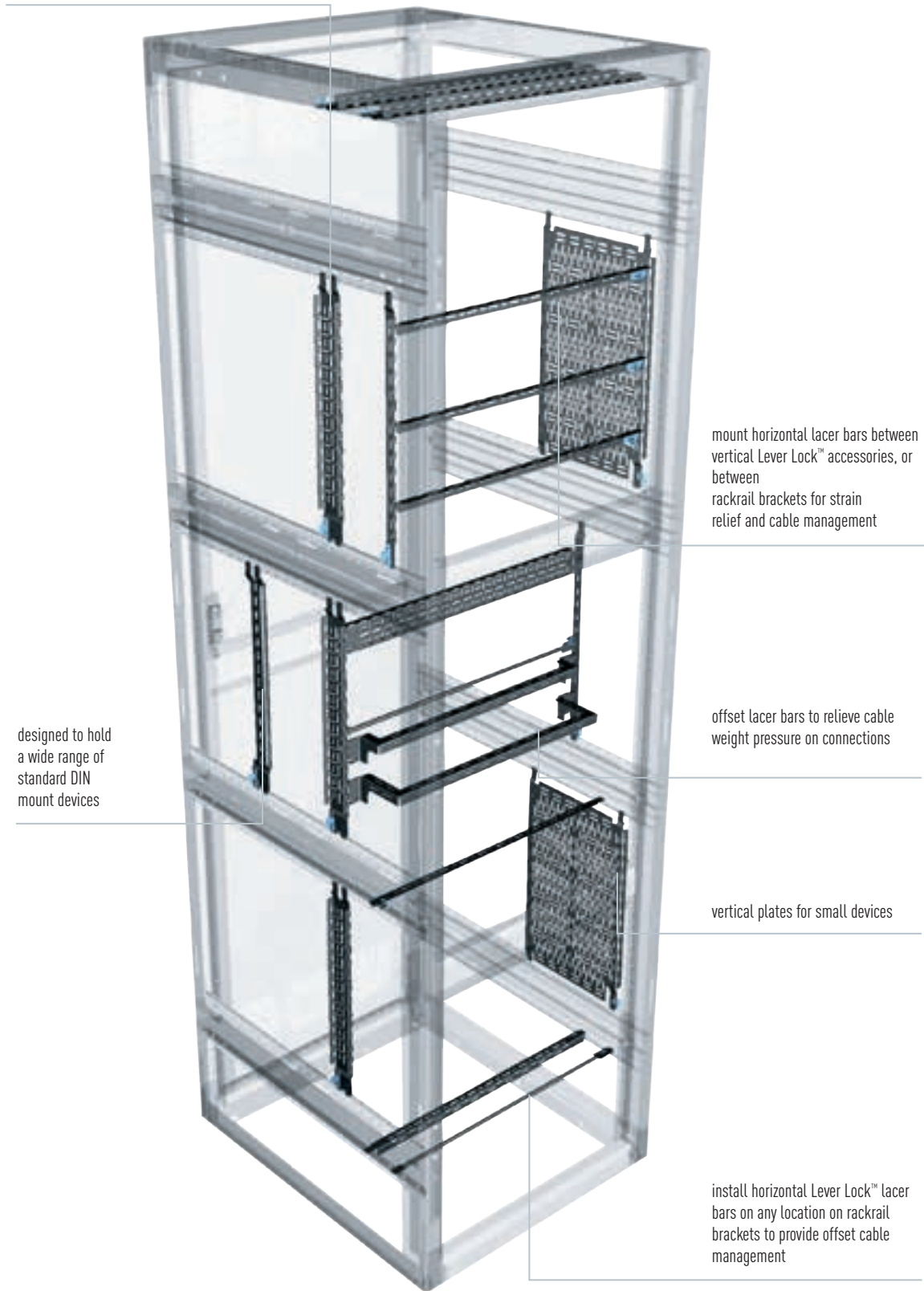

mount horizontal lacer bars between vertical Lever Lock™ accessories, or between rackrail brackets for strain relief and cable management

designed to hold a wide range of standard DIN mount devices

offset lacer bars to relieve cable weight pressure on connections

vertical plates for small devices

install horizontal Lever Lock™ lacer bars on any location on rackrail brackets to provide offset cable management

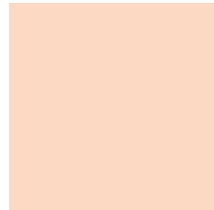

Cable Management

System needs for cabling & connectivity is growing exponentially. The more cables, the more critical it becomes to manage the cable entry, exit and within the enclosure to obtain a neat, organized system- but more importantly, allows for proper airflow & thermal management.

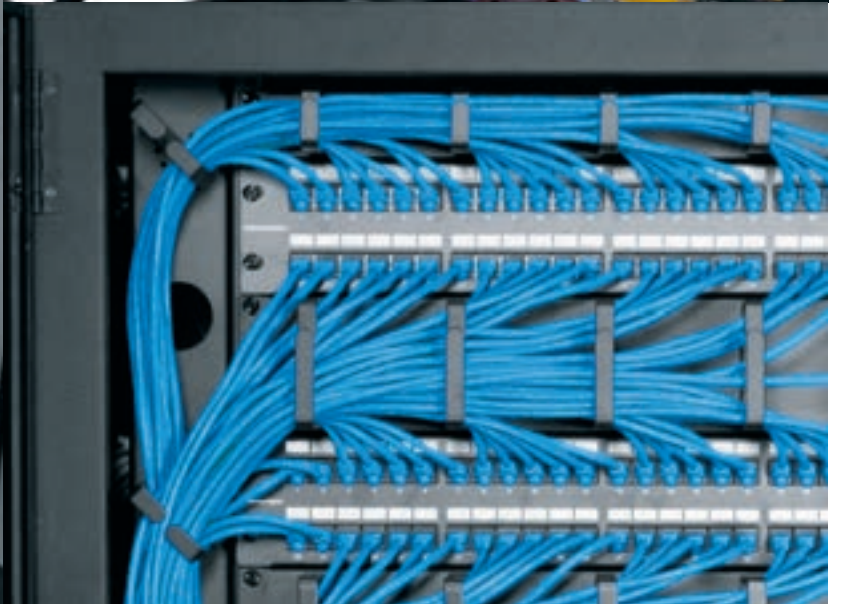

Middle Atlantic Products offers a range of cable support products to meet any system needs including vertical & horizontal options, ducts, ladders and all the accessories.

HORIZONTAL	104 - 106
VERTICAL	107

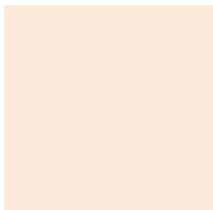

HORIZONTAL CABLE MANAGEMENT

Middle Atlantic Products offers a range of horizontal cable support products prevent cable strain by organizing and routing cables from rear component connections to the side of the rack.

LBP SERIES, HORIZONTAL LACER BARS

Horizontal lacer bars provide cabling support in the region of the mounted equipment itself, carrying cables horizontally from the sides of the rack to the connection points.

- Choice of round, rectangular, and "L" shaped profiles
- Choice of straight and offset styles
- Steel construction with black powder coat finish (except rectangular lacing bars of aluminum construction)
- Sold in packs of 10 pieces

PART #	SHAPE	OFFSET	QUANTITY
LBP-1S*	rectangular	-	10
LBP-1R	round	-	10
LBP-1R4	round	102mm offset	10
LBP-1.5	round	38mm offset	10
LBP-1.5R90	round	38mm offset	10
LBP-4R90	round	102mm offset	10
LBP-6R90	round	152mm offset	10
LBP-10R90	round	254mm offset	10
LBP-1A	L-shaped	-	10
LBP-2A	L-shaped	51mm offset	10
LBP-4A	L-shaped	102mm offset	10
LBP-6A	L-shaped	152mm offset	10

*aluminum construction

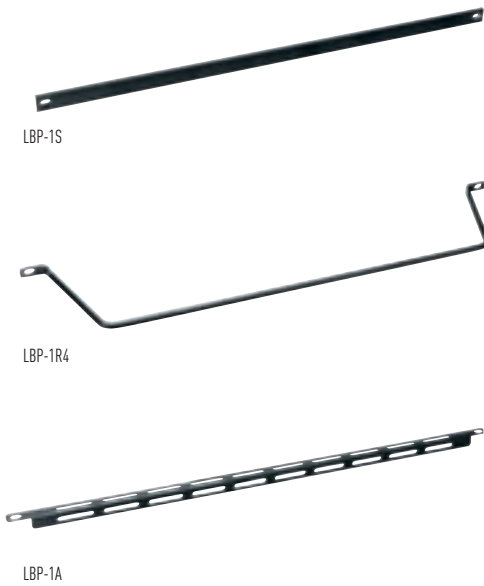

- cable management friendly hardware see pg. 122

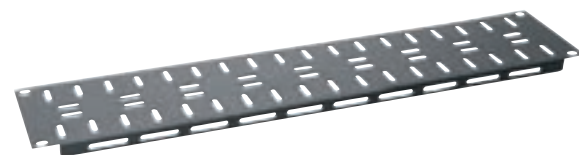

LBP-LTF



LBP SERIES, HORIZONTAL LACER BARS

- For large amounts of cable or mounting small devices

PART #	RACKING HEIGHT	QUANTITY	PANEL WIDTH
UP1	44mm (1 space)	1	483mm
LBP-LTF	89mm (2 space)	10	483mm

LB SERIES, TELESCOPING LACER BAR SYSTEM

Telescoping lacer bars are adjustable to meet the specific mounting requirements of various enclosures. Unique design accepts mounting of Middle Atlantic Products vertical power strips and vertical lacer strips.

- Choice of adjustable models for side-to-side (LBH products) and front-to-back support (LBFR products)
- LBFR-5A lacer bars have similar function but are fixed length
- Steel construction with black powder coat finish
- Sold in packs of 2

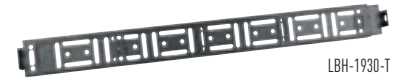

LBH-1930-T

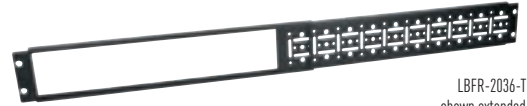

LBFR-2036-T
shown extended

PART #	DESCRIPTION	TELESCOPING RANGE (MOUNTING HOLE TO MOUNTING HOLE)	USEABLE DEPTH OF RACK (REQUIRES REAR RACKRAIL)	HEIGHT	PRE-PACK QUANTITY
LBH-1930-T	horizontal telescoping lacer bar	483mm to 762mm		44mm	2
LBFR-1626-T	front to rear telescoping lacer bar	406mm to 660mm	518mm to 695mm	73mm	2
LBFR-2036-T	front to rear telescoping lacer bar	508mm to 914mm	543mm to 949mm	73mm	2
LBFR-3650-T	front to rear telescoping lacer bar	914mm to 1270mm	949mm to 1305mm	73mm	2
LBFR-5A-16	front to rear lacer bar (fits SAX and SSAX racks)	368mm only	406mm	73mm	2

HCM SERIES, HORIZONTAL CABLE MANAGERS

Organize patch cords and similar cabling while maintaining the a required bend radius. Available in a wide variety of styles to suit most applications. For optimal performance, do not exceed a 50% fill rate when passing cables through cable rings.

- Choice of styles including "D-ring" and "micro-clip"
- Choice of one and two space sizes
- Steel construction with black powder coat finish



HCM-1



HCM-2DV



D-RING

PART #	DESCRIPTION	PANEL WIDTH	CABLE RINGS FILL AREA	END RINGS FILL AREA
HCM-1	44mm (1 rackspace) "micro-clip" style	483mm	22mm ²	
HCM-1D	44mm (1 rackspace) "D-Ring" style	483mm	83mm ²	
HCM-1DV	44mm (1 rackspace) "D-Ring" style, w/ end D-Rings	483mm	83mm ²	190mm ²
HCM-2DV	89mm (2 rackspace) "D-Ring" style, w/ end D-Rings	483mm	190mm ²	190mm ²

ACCESSORIES

HORIZONTAL CABLE MANAGEMENT



HHCM shown open

HHCM shown closed

HHCM SERIES, HINGED HORIZONTAL CABLE MANAGERS

Conceal patch cables while providing cable strain relief with the hinged horizontal cable managers.

- Hinged front panel has a magnetic closure
- Helps maintain the required bend radius
- Steel construction with black powder coat finish

PART #	RACKING HEIGHT	DEPTH
HHCM-1	44mm (1 rackspace)	92mm
HHCM-2	89mm (2 rackspace)	92mm



PHCM typical

PHCM SERIES, HORIZONTAL CABLE MANAGERS

Ample cable pass-throughs provided for dressing cables above, below, to the sides and behind the cable manager.

- Available in single and 4-packs

SINGLE PIECE PART #	4 PACK PART #	DESCRIPTION
PHCM-1-2	PHCM-1-2-P4	1 rackspace (44mm) plastic finger horizontal cable manager, 51mm deep



BR1 application

BR SERIES, BRUSH GROMMET CABLE PASS-THROUGH PANEL

The brush grommet panel provides a clean, organized cable entry method when mounted above any work surface. Also fits in opening on all MW Series top options.

- Built-in cable management tray
- Steel construction with black powder coat finish

PART #	RACKING HEIGHT
BR1	44mm (1 rackspace)
BR2	89mm (2 rackspace)

VERTICAL CABLE MANAGEMENT

Middle Atlantic Products offers a range of vertical cable support products to prevent cable strain by organizing and routing cables along side the rack. Properly dressed installations not only look better, but better support the thermal management strategy and make ongoing maintenance and changes easier.



OWP Series
LACE-44-OWP



OP Series
LACE-40-OP



LP Series
LACE-44LP



P Series
LACE-P



1SP Series
LACE-44-1SP



1P Series
LACE-441P

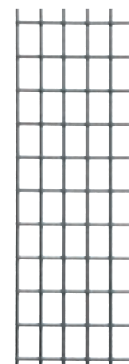

WB6 Series
LACE-WB6-24

SERIES	PART #	RACKING HEIGHT	WIDTH	TIE POINTS	QTY	COMPATIBLE CABLE MANAGEMENT OPTIONS			
						CABLE TIES	TWS	TW12	CAGE NUTS
OWP	LACE-5254-OWP	52-54 rackspace	121mm	mixed slip-on posts, cage nut holes and round holes	6	✓	✓	✓	✓
	LACE-44-OWP	44 rackspace	121mm	mixed slip-on posts, cage nut holes and round holes	6	✓	✓	✓	✓
	LACE-40-OWP	40 rackspace	121mm	mixed slip-on posts, cage nut holes and round holes	6	✓	✓	✓	✓
	LACE-37-OWP	37 rackspace	121mm	mixed slip-on posts, cage nut holes and round holes	6	✓	✓	✓	✓
	LACE-23-OWP	23 rackspace	121mm	mixed slip-on posts, cage nut holes and round holes	6	✓	✓	✓	✓
	LACE-13-OWP	13 rackspace	121mm	mixed slip-on posts, cage nut holes and round holes	6	✓	✓	✓	✓
OP	LACE-5254-OP	52-54 rackspace	83mm	mixed slip-on posts, cage nut holes and round holes	6	✓	✓	✓	✓
	LACE-44-OP	44 rackspace	83mm	mixed slip-on posts, cage nut holes and round holes	6	✓	✓	✓	✓
	LACE-40-OP	40 rackspace	83mm	mixed slip-on posts, cage nut holes and round holes	6	✓	✓	✓	✓
	LACE-37-OP*	37 rackspace	83mm	mixed slip-on posts, cage nut holes and round holes	6	✓	✓	✓	✓
	LACE-23-OP	23 rackspace	83mm	mixed slip-on posts, cage nut holes and round holes	6	✓	✓	✓	✓
	LACE-13-OP	13 rackspace	83mm	mixed slip-on posts, cage nut holes and round holes	6	✓	✓	✓	✓
P	LACE-P	45 rackspace	51mm	round holes	6	✓	✓		
	LACE-37P	37 rackspace	51mm	round holes	6	✓	✓		
	LACE-13P	13 rackspace	51mm	round holes	6	✓	✓		
1SP	LACE-44-1SP	44 rackspace	25mm	10 pre-installed tie saddles	6	✓	inc.	✓	
1P	LACE-44-1P	44 rackspace	25mm	tie saddles	6	✓	✓		
	LACE-37-1P	37 rackspace	25mm	tie saddles	6	✓	✓		
WB6	LACE-WB6-24	24 rackspace	152mm	vertical wire grid lace	1				
	LACE-WB6-42	42 rackspace	152mm	vertical wire grid lace	1				
	LACE-WB6-45	45 rackspace	152mm	vertical wire grid lace	1				



Thermal Management

Thermal Management plays a critical role in overall system reliability because heat has been proven to substantially reduce the service life of most equipment.

Maintaining the recommended constant operating temperature for most equipment (max 29.5 Celsius) will help provide a long service life for the equipment inside an enclosure.



Why 29.5 Celsius? Most studies have shown that for every 10° rise, digital equipment life is reduced by approximately 40%!

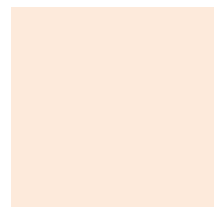



IUQFP-4D



IUQFP-4RT



IUQFP-4DRA
designer look and finish

IUQFP SERIES, ULTRA QUIET FAN PANELS

These award-winning premium cooling panels are quiet and effective. Ideal for cooling smaller systems in visible locations such as living spaces and AV studios. Designer versions also feature dimmable displays and have a black brushed and anodized finish.

- Compact two-space size saves rackspace
- Thermostatic, proportional speed fan control is quiet and saves energy
- Includes local and remote overtemp notification for system reliability
- Choice of black powder coat or black brushed and anodized finish

CERTIFICATIONS

- CE

240V PART #	RACKING HEIGHT	# OF FANS	OVERTEMP NOTIFICATION			USER DEFINABLE OVERTEMP SETTING	FAN FAILURE NOTIFICATION LOCAL & REMOTE DISPLAY	FREE AIR RATING	MAX SOUND LEVEL	FINISH	AESTHETICS
			LOCAL LED	LOCAL DISPLAY	REMOTE						
IUQFP-2	89mm (2 space)	2	✓	-	✓	-	-	50 CFM	24 dB	black powder coat	basic
IUQFP-2D	89mm (2 space)	2	✓	✓	✓	✓	✓	50 CFM	24 dB	black powder coat	basic
IUQFP-4	89mm (2 space)	4	✓	-	✓	-	-	100 CFM	27 dB	black powder coat	basic
IUQFP-4D	89mm (2 space)	4	✓	✓	✓	✓	✓	100 CFM	27 dB	black powder coat	basic
IUQFP-4DRA	89mm (2 space)	4		dimnable	✓	✓	✓	100 CFM	27 dB	black, brushed & anodized	designer
IUQFP-4RA	89mm (2 space)	4			✓			100 CFM	27 dB	black, brushed & anodized	designer

IQBP SERIES, QUIET BLOWER PANELS

This unique product series from Middle Atlantic uses a pair of our custom-designed blowers to move up to 100mm of cooling air quietly in only one rackspace! Intelligent proportional speed control, and high static pressure to maintain airflow even through crowded rackspace.



IQBP-2

- Compact one-space unit saves rackspace
- Choice of black powder coat or black brushed and anodized finish
- Half rack size available

CERTIFICATIONS

- CE

240V PART #	BLACK FINISH	# OF BLOWERS	MAX SOUND LEVEL	FREE AIR RATING	RACKING HEIGHT	OVERALL WIDTH
IQBP-2A	Anodized	2	32 dB	100 CFM	44mm (1 space)	483mm
IQBP-2	Flat	2	32 dB	100 CFM	44mm (1 space)	483mm



FTA-3

FTA SERIES, FAN TRAY SYSTEM

Locates fans directly above hot equipment to help supplement rack cooling systems by moving hot air in the right direction.

- Uses 102mm DC fans for quiet operation
- 8 fan mounting positions and optional add-on fan to position fans where needed
- Energy-saving thermostatic control
- Adjustable mounting range of 457-813mm
- Compact one-space unit saves rackspace
- Ideal for use with VRS vented rackmount shelf, pg. 196

240V PART #	DESCRIPTION	FREE AIR RATING
IFTA-3	3 fan tray	207mm
IFTA-6	6 fan tray	414mm

QUIET-COOL SERIES™, COMPONENT, CABINET AND CLOSET COOLING

Middle Atlantic offers this unique set of products called Quiet-Cool Series™, which was designed to provide effective thermal management for several specific installation environments. Every product in this series employs smart thermostatic control to save energy and reduce unnecessary noise.

COMPONENT COOLER

- Lays on top of hot components to move air

CERTIFICATIONS

- CE

240V PART #	DESCRIPTION	FREE AIR RATING	MAX SOUND LEVEL
ICOMP-COOL	1 fan, power supply	8mm	19 dB
ICOMP-COOL-3*	3 fans, connects to single power supply	8mm per fan	24 dB
ICOMP-COOL50	system activates automatically when needed	50mm	29 dB
ICOMP-COOL50P	platform, system activates automatically when needed	50mm	29 dB

*914mm length between connectors



ICOMP-COOL50

CABINET COOLER

- Mounts inside small cabinets, credenzas, or similar enclosures to move air

CERTIFICATIONS

- CE

240V PART #	DESCRIPTION	FREE AIR RATING	MAX SOUND LEVEL
ICAB-COOL	cabinet cool system	20 CFM	24 dB
ICAB-COOL50	cabinet cool system	50 CFM	29 dB
ICAB-COOL-2	dual cabinet cool system	40 CFM	27 dB



ICAB-COOL50

CLOSET COOLER

- For small systems in enclosed closes

CERTIFICATIONS

- CE

240V PART #	DESCRIPTION	FREE AIR RATING	MAX SOUND LEVEL
ICLS-COOL1	active exhaust, passive intake	50 CFM	25 dB
ICLS-COOL2	active exhaust, active intake	50 CFM	28 dB



ICLS-COOL1

FANS, FAN KITS AND ACCESSORIES

Middle Atlantic offers a range of high quality fans and fan kits to let installers implement their selected thermal management strategy. Fan kits include fans, guards, and necessary vent blockers, and are designed for specific racks or usage locations such as for rear doors as noted. Some kit models also include intelligent thermostatic controls to save energy and minimize unnecessary noise.

- Fans are ball-bearing design for long life and quiet operation
- Fans include mounting hardware and cords
- Fan kits include fans, guards, and necessary vent blockers

FANS



AXS-FAN



FAN-6

PART #	VOLTAGE	SIZE	DEPTH	FREE AIR DB RATING	FREE AIR RATING
QFAN	120V	114mm	38mm	<30 dBA	50 CFM
FAN-10	120V	254mm	89mm	49 dBA	550 CFM
FAN-119	240V	114mm	38mm	39 dBA	95 CFM
QFAN-119	240V	114mm	38mm	<30 dBA	50 CFM

FAN KITS

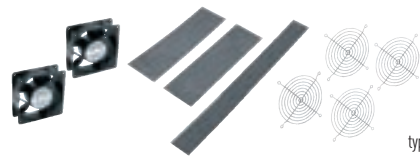

typical fan kit

PART #	APPLICATION	# OF FANS	FREE AIR RATING	OTHER ITEMS INCLUDED
IMFR-FANKIT-2	rear panel, fits MFR Series	2	50 CFM	power supply, 240V

FILTER PANEL



FILTER

PART #	RACKING HEIGHT	DESCRIPTION
FILTER	133mm (3 spaces)	1" thick, washable fan filter panel

FAN GUARDS

PART #	FITS
GUARD	114mm fan
GUARD-10	254mm fan

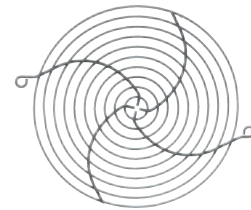

VBK SERIES, VENT BLOCKER KIT

Vent blockers prevent the recirculation of hot air between top-mount fans and nearby vent openings to ensure the heated air will be forced out through the top mounted fans.

- Kits include the properly sized blockers for the intended model

PART #	FITS
VBK-E20	ERK-xx20, DWR-xx-26
VBK-E28	ERK-xx28

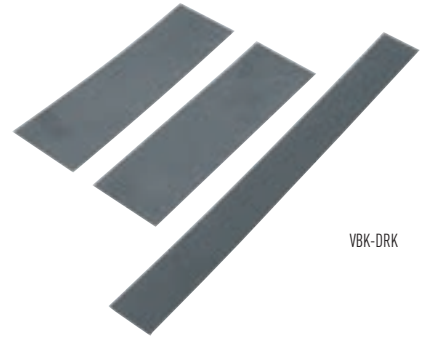

VBK-DRK

FC SERIES, THERMOSTATIC AC FAN CONTROL

These controllers extend both equipment and fan life and reduce service calls by varying the fan speed of up to four fans based on temperature.

- Control up to four fans, depending on model
- 3 user-selected temperature ranges
- Includes temperature sensor with 1524mm cord
- ETL Certified

CERTIFICATIONS

- CE

PART #	DESCRIPTION	# OF FAN CONTROLLED OUTLETS
FC-4-1CA	mounts to rackrail brackets or any flat surface	4



FC-4-1CS

ACCESSORIES HIGH DEFINITION RACKMOUNT CONSOLES

HIGH DEFINITION RACKMOUNT CONSOLES

High Definition LCD Rackmount Consoles are designed for the needs of the AV system, with a 100% digital platform that maintains complete digital signal integrity. This results in data that remains intact between source and display with no compatibility issues and no need for specialty cabling or accessories. Supporting a broad range of applications, rackmount consoles are ideal whenever rackmount control and system monitoring is required.



RM-KB-LCD17KVMHD

- High definition (1080p), widescreen (16:9)
- Designed for digital video, featuring an HDMI® certified 100% digital platform including HDMI/DVI inputs and HDCP compliance
- No special cables required – compatible with industry standard cables and extenders
- KVM model is IP-enabled for remote monitoring and management
- Models available in standard console configuration for single systems or console with 8 Port KVM for managing multiple systems from a single station
- Compact, 1-rackspace design includes 432mm widescreen display, keyboard & touchpad
- Dual rail design allows monitor to reside in open position for system monitoring while keyboard is recessed
- Fast one-person installation with quick-install rails
- Front USB port
- Supplied with U.S. style line cord

CERTIFICATIONS

- CE



RM-KB-LCD17HD



RM-KB-LCD17KVMHD

PART #	SCREEN SIZE	RESOLUTION	RACKING HEIGHT	INPUTS	REMOTE CONSOLE OUTPUTS	IP-ENABLED
RM-KB-LCD17HD	432mm (16:9)	1080p (HD)	44mm (1 space)	VGA, DVI, HDMI, USB	VGA, DVI, HDMI, USB	-
RM-KB-LCD17KVMHD				HDMI (8), USB (8), DVI (6)	HDMI, USB (2)	yes

Lighting

Middle Atlantic offers a range of rackmount lighting and work lights to meet a variety of needs. Rackmount lighting is there when you need it; we offer styles for both back-of-the-rack and end-user front accessible lighting. And, we offer several styles of work light to meet installer and maintenance needs. Explore the offerings below to find the most appropriate model.

LT-GN SERIES, LED GOOSENECK LIGHT

- Portable lights can be powered by USB port or standard 120V outlet
- Rackmount panel version has two independently positionable lights
- Lights have off/on switch
- Long-lasting LED sources stay cool and bright

PART #	DESCRIPTION	POWERED BY
LT-GN	goose-neck LED light with USB connector	PDLT-815RVA, PD-915RV-RN, LT-1Rx or any computer w/ standard USB port
LT-GN-PL	goose-neck LED light with USB 120V adapter	Any 120V power outlet, including vertical power strips
LT-GN-PNL	one rackspace rackmount panel with dual goose-neck LED lights	
LT-GN-WL	magnetic worklight, goose-neck, includes 32 LED lights	



LT-1R SERIES, RACKMOUNT LIGHT

Rackmount lighting features retractable LED light for evenly distributed illumination of the rackmounted components below.

- One-space design to save space
- Choice of black powder coat or black brushed and anodized finish

PART #	CORD LENGTH	CHASSIS DEPTH	FINISH
LT-1R	2743mm	189mm	black powder coat
LT-1RA	2743mm	189mm	black brushed and anodized



WL Series, Magnetic Work Light

- Powerful magnets keep lights in place and attach to any steel rack surface
- Cool, efficient fluorescent bulb
- UL Listed

PART #	DESCRIPTION	POWERED BY
WL-60	magnetic work light, jointed arm, v13W fluorescent bulb, long 18' cord	Any 120V power outlet, including vertical power strips



SECURITY OPTIONS

Middle Atlantic Products knows that many systems are installed in semi-accessible or accessible locations and so we offer a selection of security covers, doors and rackscrews to protect valuable equipment and critical connections. Models in this section include solid and vented covers as well as lockable solid and plexi doors to match the needs of the project.

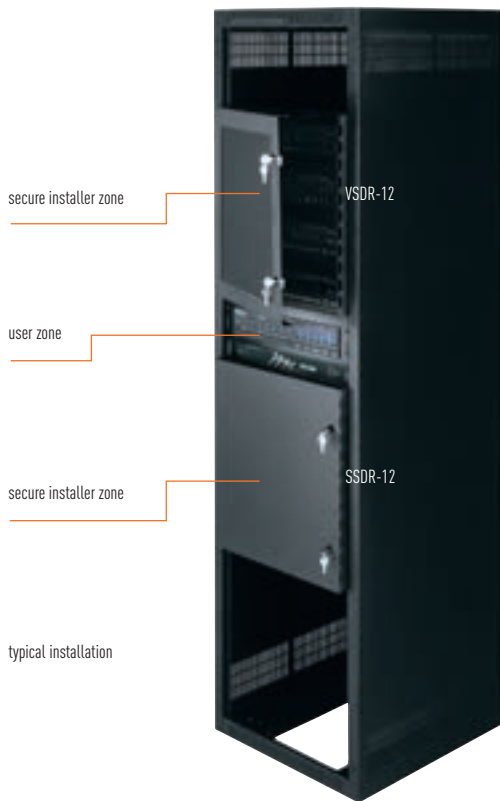

SECURITY DOORS

Hinged, keylocked security doors allow front access to a select portion of rackmount equipment. Mount equipment which needs to be secured behind these doors in the "installer zone" to keep unauthorized users from tampering. Keep equipment which needs to be client-accessed in the open portion of the rack in the "user zone."

- Choice of plexiglass, vented, and solid styles
- Sturdy steel construction with black powder coat finish

SOLID PART # KNOB CLEARANCE 35MM	PLEXI PART # KNOB CLEARANCE 29MM	VENTED PART # KNOB CLEARANCE 29MM	RACKING HEIGHT
SSDR-8	PSDR-8	VSDR-8	356mm (8 rackspace)
SSDR-12	PSDR-12	VSDR-12	533mm (12 rackspace)
SSDR-15			667mm (15 rackspace)
SSDR-16	PSDR-16	VSDR-16	711mm (16 rackspace)
SSDR-20	PSDR-20	VSDR-20	889mm (20 rackspace)
SSDR-21			933mm (21 rackspace)

HINGED SECURITY COVERS

Cover specific equipment while allowing access with a key. Smoked plexiglass doors allow visibility to protected equipment.

- Steel frame with keylocked 3/406mm smoked-gray plexiglass door
- 38mm depth easily clears controls on most equipment
- Use with security screws for additional security (pg. 240)
- Available in 2, 3, 4, and 8 rackspace sizes

PART #	RACKING HEIGHT
SECL-2	89mm (2 rackspace)
SECL-3	133mm (3 rackspace)
SECL-4	178mm (4 rackspace)
SECL-8	356mm (8 rackspace)



SECL-2



SECL-3



SECL-4

FIXED SECURITY COVERS

Fight equipment tampering with these tough fixed security covers. Secure and cost-effective.

- Choice of regular or fine metal perforation or fixed plexiglass window for easy equipment viewing
- 25mm depth clears controls on most equipment
- Use with security screws for additional security

TYPE	PART #	RACKING HEIGHT
Regular Perf Allows unobstructed view of knob settings, 64% open area	S1	44mm (1 rackspace)
	S2	89mm (2 rackspace)
	S3	133mm (3 rackspace)
	S4	178mm (4 rackspace)
Fine Perf Allows sight of LEDs, most secure, 25% open area	SF1	44mm (1 rackspace)
	SF2	89mm (2 rackspace)
	SF3	133mm (3 rackspace)
	SF4	178mm (4 rackspace)
Plexiglass	SL-1	44mm (1 rackspace)
	SL-2	89mm (2 rackspace)
	SL-3	133mm (3 rackspace)



S1
regular perforated



SF1
fine perforated



SL-1
plexiglass

BLANK PANELS

Blank panels cover open areas on an installed rack face, providing a clean, professional appearance. Blank panels also serve an essential thermal management function by blocking unwanted airflow.

- Completes a finished, professional appearance
- Supports thermal management by preventing recirculation of hot air
- Sizes from 1/3 space up to 6 space panels
- Matching finishes are available



EB1-H



EB1/3



FEB1

ECONOMY BLANK STEEL PANELS

- 1/3 and 1/2 space panels ideal for non-fullspace components
- Panels in contractor packs are individually poly-bagged for protection

FLANGED PART #	FLAT PART #	RACKING HEIGHT
EB1	FEB1	44mm (1 rackspace)
EB2	FEB2	89mm (2 rackspace)
EB3	FEB3	133mm (3 rackspace)
EB4	FEB4	178mm (4 rackspace)
EB5	FEB5	222mm (5 rackspace)
EB6	FEB6	267mm (6 rackspace)
EB1/2		22mm (1/2 rackspace)
EB1/3		15mm (1/3 rackspace)
EB1-H*		44mm (1 rackspace)

CONTRACTOR/MASTER PACKS		
FLANGED PART #	FLAT PART #	QTY
EB1-CP12	FEB1-CP12	12
EB2-CP12	FEB2-CP12	12
EB3-CP6	FEB3-CP6	6
EB4-CP6	FEB4-CP6	6
EB1MP	FEB1MP	50
EB2MP	FEB2MP	25

*blank panel has handles for gripping pull-out rack systems

FLAT BLACK ALUMINUM BLANK PANELS

- Choice of flanged or flat styles
- Sizes from 1 space up to 4 space panels
- Aluminum construction; can be machined if needed
- Panels in contractor packs are individually poly-bagged for protection



PBL-2



PHBL-3



PBL-11D

FLANGED PART #	FLAT PART #	RACKING HEIGHT
PBL-1	PHBL-1	44mm (1 rackspace)
PBL-2	PHBL-2	89mm (2 rackspace)
PBL-3	PHBL-3	133mm (3 rackspace)
PBL-4	PHBL-4	178mm (4 rackspace)
PBL-11D*		44mm (1 rackspace)

CONTRACTOR/MASTER PACKS		
FLANGED PART #	FLAT PART #	QTY
PBL1-CP12	PHBL1-CP12	12
PBL2-CP12	PHBL2-CP12	12
PBL3-CP6	PHBL3-CP6	6
PBL4-CP6	PHBL4-CP6	6

*comes with ID strip

TEXTURED BLANK STEEL PANELS

- Complements RSH4S custom rackselves and other textured accessories
- Sturdy steel construction
- Sizes from 1 space up to 6 space panels
- Panels in contractor packs are individually poly-bagged for protection

FLANGED PART #	RACKING HEIGHT	CONTRACTOR/MASTER PACKS	
		FLANGED PART #	QTY
SB1	44mm (1 rackspace)	SB1-CP12	12
SB2	89mm (2 rackspace)	SB2-CP12	12
SB3	133mm (3 rackspace)	SB3-CP6	6
SB4	178mm (4 rackspace)	SB4-CP6	6
SB5	222mm (5 rackspace)		
SB6	267mm (6 rackspace)		



BLACK BRUSHED AND ANODIZED BLANK PANELS

- The most aesthetic blank panels available with a black brushed and anodized finish
- Choice of flanged or flat styles
- Aluminum construction with premium anodized finish
- Sizes from 1/3 space up to 6 space panels
- 1/3 and 1/2 space panels ideal for non-fullspace components
- Complements RSH4A custom rackselves and other anodized accessories

FLANGED PART #	FLAT PART #	RACKING HEIGHT	FLANGED PART #	FLAT PART #	RACKING HEIGHT
BL1	HBL1	44mm (1 rackspace)		HBL6	267mm (6 rackspace)
BL2	HBL2	89mm (2 rackspace)	BL1/2		22mm (1/2 rackspace)
BL3	HBL3	133mm (3 rackspace)	BL1/3		15mm (1/3 rackspace)
BL4	HBL4	178mm (4 rackspace)	BL1-H*		45mm (1 rackspace)
	HBL5	222mm (5 rackspace)			

*blank panel has handles for gripping pull-out rack systems



WRINKLED BLANK PANELS

- Sturdy steel construction with flanges for extra strength
- Sizes from 1 space up to 4 space panels

FLANGED PART #	RACKING HEIGHT
WSB1	44mm (1 rackspace)
WSB2	89mm (2 rackspace)
WSB3	133mm (3 rackspace)
WSB4	178mm (4 rackspace)



VENT PANELS

Vent panels cover open areas on an installed rack face, providing a clean, professional appearance, while maintaining open area for cooling airflows. Middle Atlantic Products stocks many variations to meet every project need.

Note: venting is not always better – for more information on cooling strategies and practices, please see our white paper or contact our professional technical support department.

- Completes a finished, professional appearance
- Supports thermal management by allowing cooling airflows
- Sizes from 1 space up to 4 space panels
- Matching finishes are available

FLAT BLACK VENT PANELS

- Sturdy steel construction
- Sizes from 1 to 4 spaces
- VTB models manufactured with light blocking material
- Panels in contractor packs are individually poly-bagged for protection



17% OPEN AREA	RACKING HEIGHT
FLAT PART #	
EVT1	44mm (1 rackspace)
EVT2	89mm (2 rackspace)
HR-EVT1*	44mm (1 rackspace)
HR-EVT2*	89mm (2 rackspace)

64% OPEN AREA	25% OPEN AREA	RACKING HEIGHT
PERF PART #	PERF PART #	
VT1	VTF1	44mm (1 rackspace)
VT2	VTF2	89mm (2 rackspace)
VT3	VTF3	133mm (3 rackspace)
VT4	VTF4	178mm (4 rackspace)

64% OPEN AREA	RACKING HEIGHT
PART #	
VTB-1	44mm (1 rackspace)
VTB-2	89mm (2 rackspace)
VTB-3	133mm (3 rackspace)

CONTRACTOR PACKS	
PART #	QTY
EVT1-CP12	12
EVT2-CP12	12

CONTRACTOR PACKS		
PART #	PART #	QTY
VT1-CP12	VTF1-CP12	12
VT2-CP12	VTF2-CP12	12
VT3-CP6	VTF3-CP6	6
VT4-CP6	VTF4-CP6	6

*Designed specifically for the HRF Series, pg. 106

PBL-11D

BLACK BRUSHED AND ANODIZED VENTED PANELS

Brushed and anodized vent panels to match other anodized components and accessories are available from 1 to 3 rackspaces.

- Aluminum construction
- Black brushed and anodized finish

17% OPEN AREA	20% OPEN AREA	RACKING HEIGHT
ANODIZED PART #	PART #	
EVIA-1	VIP-1	44mm (1 rackspace)
EVIA-2	VIP-2	89mm (2 rackspace)
	VIP-3	133mm (3 rackspace)

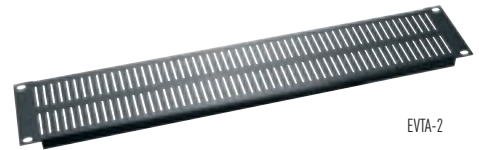

EVIA-2



VTP-2

HINGED ACCESSORY MOUNTING PANEL

Provide quick access to rack interiors for servicing and maintenance.

- Available in solid, vented or with patented universal mounting pattern for small component mounting
- Tool-less captive, threaded thumbscrews will not get lost

SOLID PART #	UNIVERSAL MOUNTING PART #	VENTED PART #	RACKING HEIGHT
AP-2	APM-2	APV-2	89mm (2 rackspace)
	APM-3		133mm (3 rackspace)
AP-4	APM-4	APV-4	178mm (4 rackspace)
AP-6		APV-6	267mm (6 rackspace)



APM-3



AP-4

CONNECTOR PANELS

Middle Atlantic Products offers a wide selection of utility and special-purpose chassis and connector panels to support your project needs. As is the case with our other products, each of these models was designed with speed and effectiveness in mind to provide installers with excellent installation results, and work with all our rack systems.



UNI-1

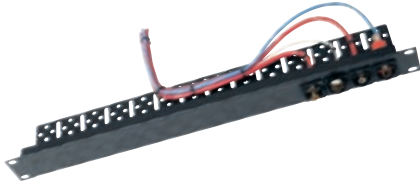

UNI-1-C

UNIVERSAL CONNECTOR PANEL

The UNI Series laser-cut connector panels feature knockouts designed to accept a number of connectors, including XLR and Neutrik.

- Design allows mounting of both male and female connectors to the same holes simply by knocking out the correct pattern
- Incorporates a 67mm strain relief shelf with tie-points for cable management (UNI-1)

PART #	LASER-CUT KNOCKOUTS	RACKING HEIGHT
UNI-1	16	44mm (1 rackspace)
UNI-2	32	89mm (2 rackspace)
UNI-1-C	16	44mm (1 space) - includes cable management

UCP SERIES, MODULAR PANEL SYSTEM

Build Your Own Custom Connector Panel Using Off-The-Shelf Components! Middle Atlantic Products UCP Series modular custom panel system assembles quickly and easily using either a 2 or 4 space frame kit and your selections from an extensive collection of prepunched modules.

- Modules accept popular connectors such as XLR, Neutrik, Elco, Canare and more
- UCP modular assemblies simply bolt together using supplied hardware
- When completed, all hardware is flush to create a professional appearance
- Visible parts have a black brushed and anodized finish
- Blank and vented panels are also available to fill unused spots
- All modules are constructed of aluminum

UCP Series Frame Kit

- Bolts modules to them in any combination

FRAME KITS PART #	RACKING HEIGHT
FK2	44mm (1 rackspace)
FK4	89mm (2 rackspace)

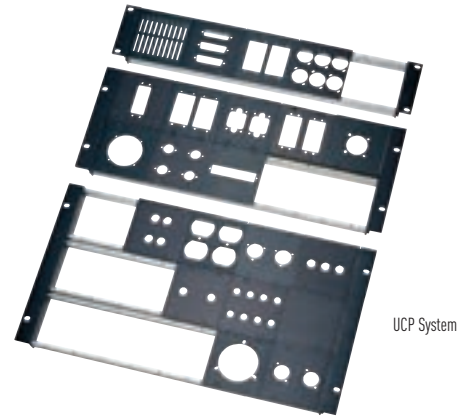
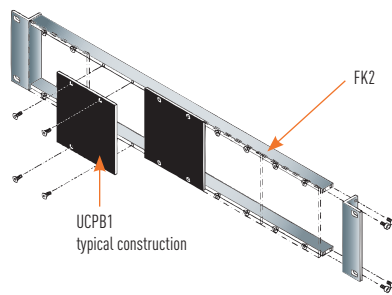

UCP SERIES CHASSIS

The 2 space UCP chassis holds five modules in the front, and five modules in the rear. Shipped fully-assembled, each unit is comprised of four threaded FK bars, a pair of ears 229mm deep, top and bottom, and all necessary module mounting hardware. The top & bottom can be easily removed, leaving the frame intact.

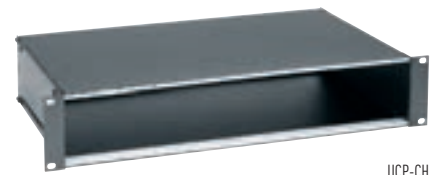

UCP SERIES CABLE TRAY, 2 SPACE

The UCP cable tray includes FK2 bars, mounting ears and bottom. 127mm deep tray provides superior cable strain relief with a multitude of wire-tie slots. Occupies 2 rackspaces (89mm).

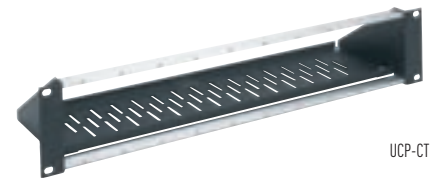

UCP SERIES HINGED FRAME KIT, 2 SPACE

This hinged version of the FK2 frame kit allows rear access to modules. Captive 10-32 threaded thumbscrews hold the frame closed and require no tools to open. Kit includes a pair of threaded FK bars, hinged ear, captive thumbscrew ear, and all module mounting hardware.



HARDWARE AND FASTENERS

Don't forget the rack screws! Professional installers know that sometimes the smallest products and details can make the difference in appearance, function, and speed. Don't let an inferior screw mar your installation – insist on Middle Atlantic hardware.

RACK SCREWS, SECURITY SCREWS AND FASTENERS

- Choice of head designs and finishes (rust-resistant finish is available)
- Most models are 19mm long with pre-installed washers and self-guiding pilot points
- Cable-friendly screws are 10mm long with rounded tip to resist chafing
- Security screws, including the patented high security Guardian Series™, provide additional equipment protection

SHOULDER WASHERS,
100 PIECES



Works with pre-installed washers on our screws to isolate equipment

SW

	SERIES	TYPE	# OF PIECES	HEAD TYPE	LENGTH	FINISH	FACTORY INSTALLED WASHER	SELF GUIDING PILOT POINTS	SECURITY ACCOMMODATIONS	COMPATIBLE BIT	RECOMMENDED & PRIMARY USE(S)
	HG	10-32 threaded	100 500 (HG500)	truss-head	19mm	black gloss, salt spray resistant	yes	yes	no	no	premium rack screws provide best bit engagement in the industry
	HM	10-32 threaded	100 500 (HM500)	truss-head	19mm	black matte	yes	yes	no	no	premium rack screws provide best bit engagement in the industry
	HP	10-32 threaded	100 500 (HP500)	truss-head	19mm	black matte	yes	no	no	no	for standard rackmounting applications; fits under optional trim strips
	HW	10-32 threaded	100 (HW100) 500 (HW500)	trim-head	19mm	black matte	yes	no	no	no	for standard rackmounting applications
	HSK	10-32 threaded	100	square post drive	19mm	black matte	yes	no	Guardian Series™ patented security hardware	optional SPBIT	highest level of security
	HTX	10-32 threaded	50	star post drive	19mm	black matte	yes	no	requires star post bit	optional TBIT	security
	HS	10-32 threaded	100	square drive	19mm	black matte	yes	no	requires square bit	optional SBIT	security
	HPQ	10-32 threaded	100 500 (HPQ-500)	truss-head	10mm	black matte	no	rounded end allow wires to be dressed inside rack without chafing	no	no	ideal for mounting vent panels and cable management bars
	HP-24	12-24 threaded	100 500 (HP24-500)	heat treated to prevent head stripping	16mm	black matte	washers included	no	no	no	telecommunications and data
	HP-6MM	6mm threaded Phillips head	100	heat treated to prevent head stripping	16mm	black matte	washers included	no	no	no	telecommunications and data
	CN1032-50	cage nut hardware, for use with 10-32 rackscrews	50	cage nut hardware	n/a	n/a	n/a	n/a	no	no	slide out servers with square hole rail
	CN6MM-100	cage nut hardware, for use with 6mm rackscrews	100	cage nut hardware	n/a	n/a	n/a	n/a	no	no	slide out servers with square hole rail

TRIM STRIPS

As a final aesthetic complement to any installation, add our finishing trim strips.

- A quick, clean and effective method of covering rack screws once the job is complete
- Each channel-shaped trim strip measures 45 spaces (2000mm long)
- Features internal grooves that fit into the supplied snap washers
- Offered in black brushed and anodized or black powder coat finish
- Cut easily to size with a hacksaw
- Sold in individual strips.



without trim strip installed



without trim strip installed

PART #	FINISH	INCLUDES
TA	black brushed & anodized	mounting screws (16), snap washers (16), end caps (8)
TS	black powder coat	mounting screws (16), snap washers (16), end caps (8)

PANELS FOR DECORA® DEVICES

Mount any low-voltage Decora device directly onto rackrail of standard 483mm enclosure. Great mounting solution for RPS Series remote power switches (pg. 186) and TEMP-DEC temperature displays (pg. 224).

- Panels take up only one rackspace
- Available models hold from one to four devices
- Flanged steel construction with durable black powder coat finish

PART #	DESCRIPTION
DECP-1X1	44mm (1 space) mounts up to 1 Decora device
DECP-1X2	44mm (1 space) mounts up to 2 Decora devices
DECP-1X3	44mm (1 space) mounts up to 3 Decora devices
DECP-1X4	44mm (1 space) mounts up to 4 Decora devices



DECP-1X1



DECP-1X3

OTHER HARDWARE

This section includes useful hardware that solves specific installation challenges, including such varied items as rail bracket adapters to touch-up paint. Browse the products in this section – you might find a solution you have been hoping for.

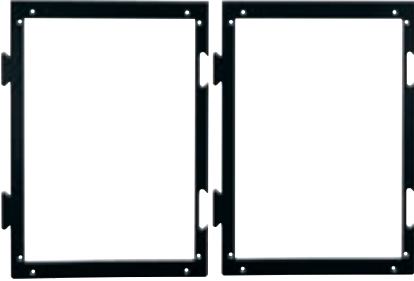

BGR-TEMP-27

MULTI-BAY FLOOR LAYOUT TEMPLATE

- Template allows accurate installation planning and mounting
- Ideal for pre-drilling floor anchor bolts, etc.
- Designed for accurate single and multi-bay layouts

MULTI-BAY FLOOR LAYOUT TEMPLATE	ACCOMMODATES
BGR-TEMP-27	BGR 686mm depth racks
BGR-TEMP-32	BGR 813mm depth racks
BGR-TEMP-38	BGR 965mm depth racks
MRK-TEMP-26	MRK 660mm depth racks
MRK-TEMP-31	MRK 787mm depth racks
MRK-TEMP-36	MRK 914mm depth racks
WRK-TEMP-27	WRK 686mm depth racks
WRK-TEMP-32	WRK 813mm depth racks

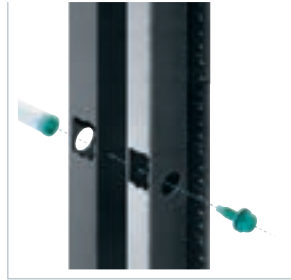

BOND-G24

SPIKE, RACK BONDING KITS

Combines ganging and electrical bonding in one step by piercing powder coat finish at bonding points without removing paint.

- Eliminates bonding wires between racks
- Provides low impedance ground
- Displaces powder coat finish without corrosion protection of painted surface
- Does not require anti-oxidant protection
- Durable and visible green finish

PART #	DESCRIPTION
BOND-G24	24 sets, 1 installation tool, 4 sets recommended per rack



ACC-KEY

KEYS

PART #	DESCRIPTION
ACC-KEY	additional set of keys for drawers and LBX
SFD-KEY	key for front door
SRD-KEY	key for rear door



DOC

DOCUMENT HOLDER

PART #	DESCRIPTION	FITS
DOC	document holder for rear door	fits on most rear doors
DOC-SACK	document holder for rear door	compatible with BGR enclosures

RRF RACKRAIL

All-steel RRF rackrail is threaded for 10-32 screws and is finished in a durable black e-coat finish. With EIA standard spacing, they are sold in pairs and designed for use with 486mm wide rough openings.

- Sturdy 3mm thick steel construction

PART #	RACKING HEIGHT
RRF2	89mm (2 space)
RRF4	178mm (4 space)
RRF6	267mm (6 space)
RRF8	356mm (8 space)
RRF10	445mm (10 space)
RRF12	533mm (12 space)
RRF14	622mm (14 space)
RRF16	711mm (16 space)
RRF18	800mm (18 space)
RRF21	933mm (21 space)
RRF27	1200mm (27 space)
RRF45	2000mm (45 space)



DRIFT PINS FOR GANGING

- Easily align racks while ganging*

PART #	DESCRIPTION
DRIFT	set of two tapered drift pins
TDRIFT	ganging drift pins, non-tapered

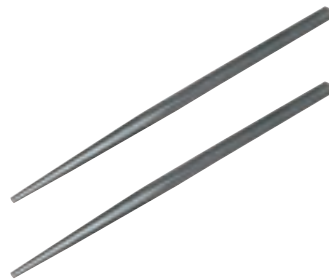

*not compliant with BGR

DRIFT

GANGING HARDWARE

- Kit of 8mm flange nuts and bolts to gang up to 10 racks

PART #	DESCRIPTION
GANG-10	8mm nuts/bolts to gang 10 racks or consoles

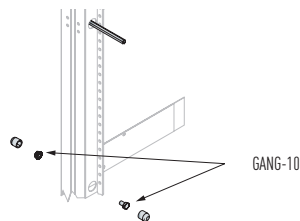

GANGING HARDWARE

- Makes ganging racks easier, comes as a set of two 13mm magnetic sockets

PART #
MAG-1/2

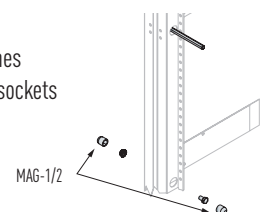

2 SPACE RACKRAIL RECESSOR, 76MM DEPTH

- Enables installer to recess equipment 76mm behind rackrail
- Comes as a pair

PART #
RR2-3RCN

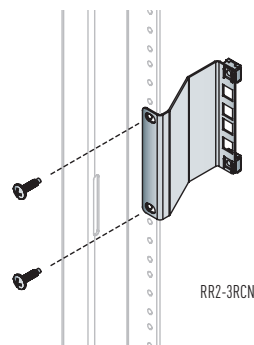



WHAT GREAT SYSTEMS ARE BUILT ON™ | legrandav.com

USA P 800.266.7225 E av.support@legrand.com

CANADA P 888.766.9770 W middleatlantic.ca

EMEA P +31 495 580 840 E av.emea.sales@legrand.com

©2019 LEGRAND AV INC. EMEAMASTERCATALOG2019 40M1/19 All other brand names or marks are used for identification purposes and are trademarks of their respective owners. All patents are protected under existing designations. Other patents pending. Not responsible for typographical errors.

EMEA HEADQUARTERS
LEGRAND AV NETHERLANDS B.V
FRANKLINSTRAAT 14
6003 DK
THE NETHERLANDS



COMMERCIAL BRANDS

Chief | Da-Lite | Middle Atlantic | Projecta | Vaddio