

AVer Pro-AV Camera Control using Visca over IP UDP and RS-232 commands

August 2021

Steps to verify the AVer PTZ310/PTZ330, TR530/320 and TR311HN / TR311 / TR313 / TR331 / TR333 cameras can be controlled with Visca commands, UDP-IP and RS-232.

Visca over IP offers the ability to send several different control commands over a network (RJ45) connection, without the need to add additional cabling.

The AVer **CL01** Camera controller can control up to 255 separate cameras on the same subnet using the Visca over IP protocol.

AVer has high quality image Cameras (TR311 / TR530 / PTZ330) that will integrate with these workflows for peak performance and ease of use. We will show the configuration process for the PTZ310/330, TR310/333, and TR530/320 Cameras using the Visca Over IP protocol.

There are several 3rd party controllers available that integrate with the AVer Pro-AV cameras, Crestron, Extron, QSC, Altona, RTI, to name a few. In this document we will discuss how to test the basic controls via software should there be an issue where the before mentioned controllers are not working as expected.



There are some pre-requisites for this to happen, see below.

Hercules Software

In order to verify “network” connectivity and control at a basic level, there is a “free” software available (Windows) for use to test the Visca over IP command strings. This is a valuable tool in order to “bypass” any hardware issues or programming issues from the devices being used.

It can be found here:

<https://www.hw-group.com/software/hercules-setup-utility>

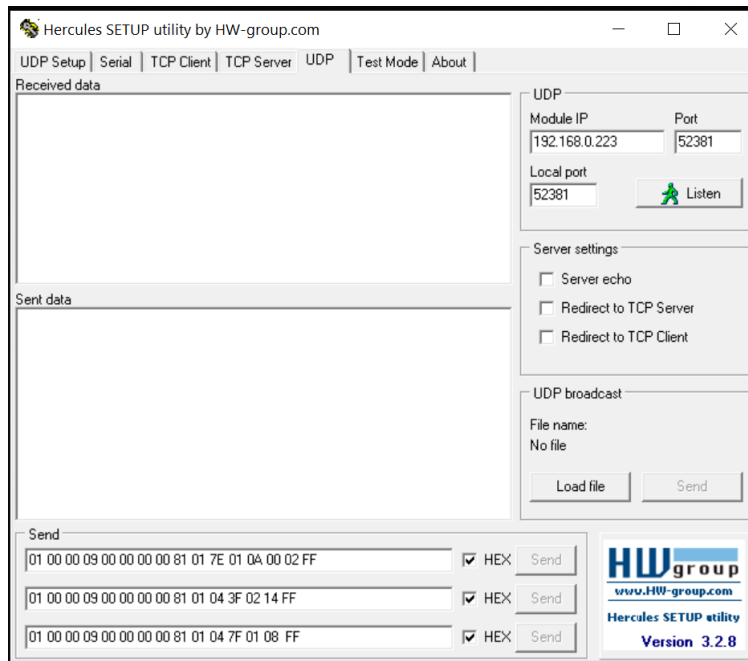

Network Connection

The AVer cameras can be connected in one of several different ways, one of those is to connect the cameras via network, using a good quality Cat5E (or better) network cable to a Gigabit network switch.

*Note: Some of our cameras do support PoE+.

PTZ310/N and PTZ330/N require **25watts** per LAN port

TR311/311HN/313/331/333 require **18 watts** per LAN port.

Here is a typical camera network connection diagram.

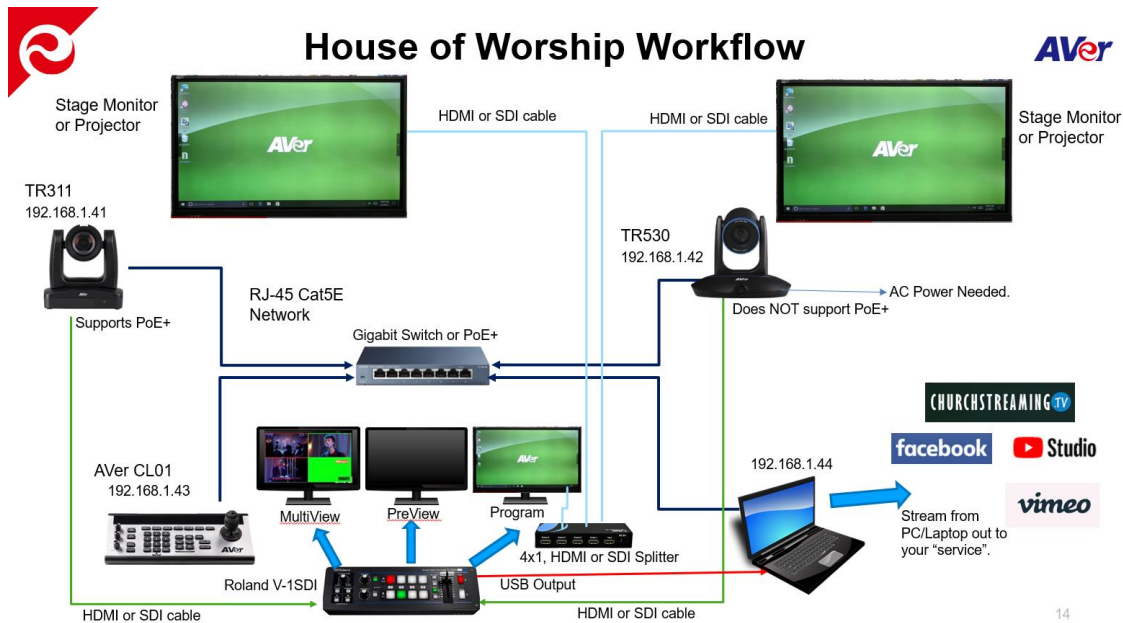

In order for the AVer CL01 to communicate to the cameras via Visca Over IP, set the camera Protocol to SonyVisca, selectable via the CL01 menu.

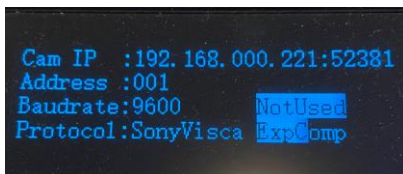

*Note: For more detailed information on the CL01 setup and configuration, refer to the CL01 Camera Controller Connection Guide or User Manual.

<https://www.averusa.com/pro-av/support/>

Network Ports

In order to check camera settings and camera control via a Chrome or IE-11 browser, verify the following ports are open/available.

VISCA Control port: 52381

Internet protocol: IPv4

CGI port: 80

Transport protocol: UDP

RTSP port: 554

AVer PTZ310 / PTZ330 Camera Setup

The AVer PTZ310/330(N) offer exceptional optical quality up to 1080p/60 video standards, Quad Output, NDI support, SRT Ready, SmartShoot motion tracking, and PoE+ support.

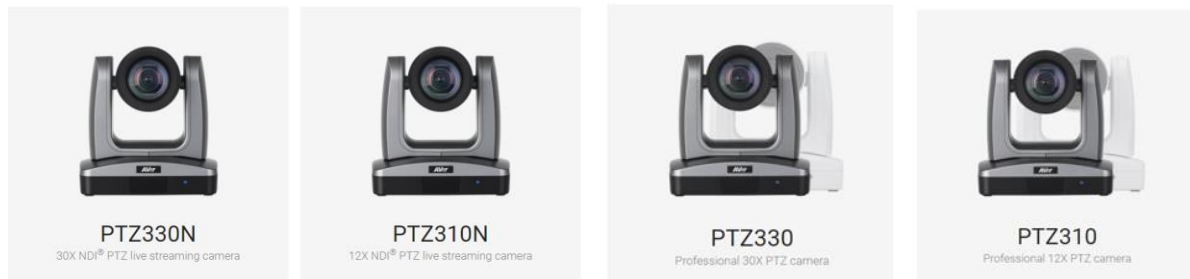

WebUI Network Connection:

1. Once all the equipment is connected, network IP's have been assigned and configured, verify you can gain access to the PTZ310/330 Camera by typing in the camera IP address in a Chrome or IE-11 browser.

***Note:** Edge, Safari and other browsers are not supported.

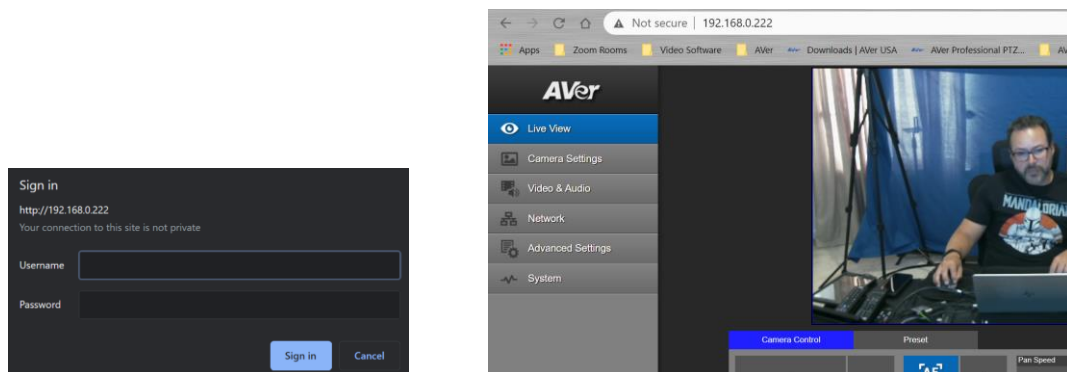

If this is the first time accessing the cameras WebUI, it will ask you for the default login credentials, which are: “admin” and “admin”

It will then ask you to change the default values, PLEASE write that information down, and then login with the NEW credentials.

2. Next, verify you can control the camera via the WebUI PTZ controls and can control the Presets, Save, Load functions.

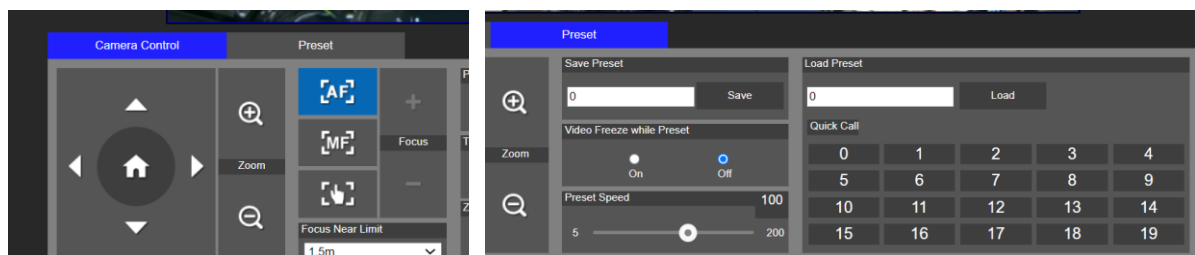

WebUI Network Connection (continued):

3. At this point you should have full control of the camera, ability to Save and Recall Presets, if you do NOT have control, most likely the control port has been disabled/blocked. Verify that port **52381** is open on the network.
4. Once the basic controls have been verified working from the WebUI of the camera, the next step is to verify that sending Visca over IP commands work via the Hercules software.

Hercules Software Testing

In this next section we will discuss using the Hercules software in a very specific way to test the Visca over IP commands are being recognized by the AVer camera.

1. Open the Hercules software and select the UDP tab.

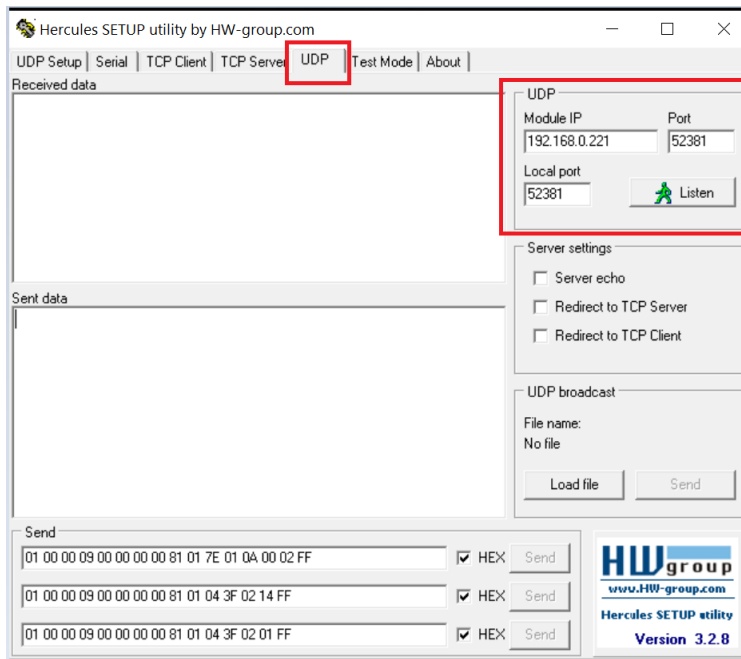

2. Next, enter the IP address of the camera as well as the Port number 52381.
3. Next, select “Listen”, you should see a green message appear, “UDP socket created”.

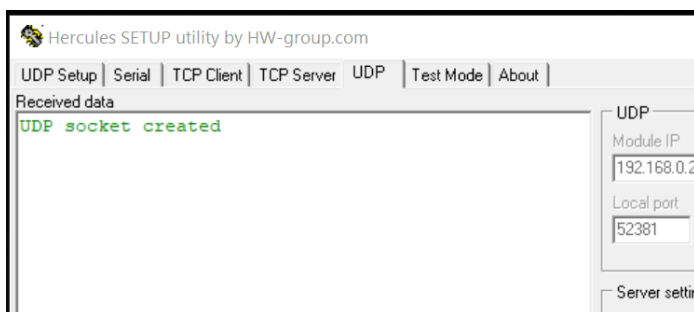

Hercules Software Testing (continued)

- Next, we now want to send a basic command to the camera via Visca over IP. For a complete list of commands, refer to the PTZ310/PTZ330/PTZ330N Control Codes document.

<https://www.averusa.com/pro-av/support/> look in the “Download” section.

In this example we will send a **Power Off** command to the camera.

01 00 00 09 00 00 00 00 81 01 04 00 03 FF

CAM_Power	On	8x 01 04 00 02 FF
	Off	8x 01 04 00 03 FF

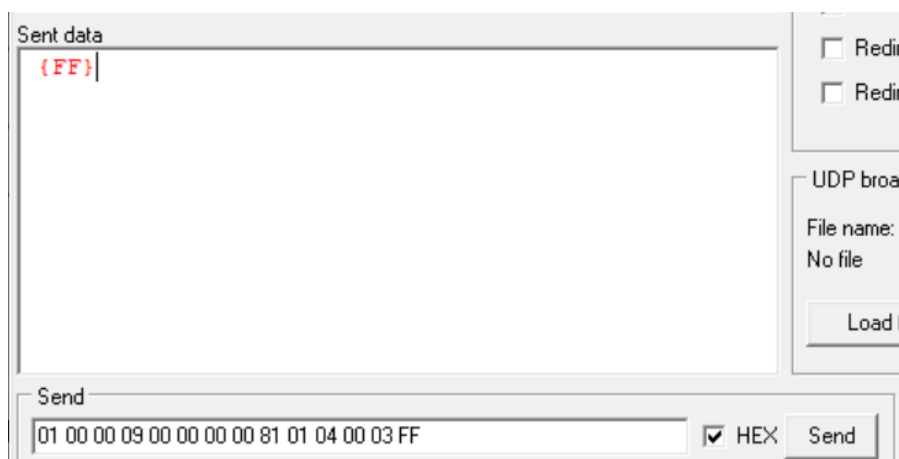

- Sending the **Power Off** command is pretty instant, the camera “may” go to a preset before powering off, if it is configured that way, the end result should be that the camera has an “Orange” LED on the front now and no video output.
- Next, let us send a **Power On** command.

01 00 00 09 00 00 00 00 81 01 04 00 02 FF



The Orange LED should now start to blink for about 5 seconds, then the Power Up routine kicks in. The PTZ310/330 camera will take about 45 seconds to boot up.

Hercules Software Testing (continued)

7. Next, let us test the **Presets, Recall Preset #1**

01 00 00 09 00 00 00 00 81 01 04 3F 02 01 FF

CAM_Memory	Reset	8x 01 04 3F 00 pp FF	pp: 0x00 To 0xFF pp: 0x5A => SmartFrame Enable pp: 0x5B => SmartFrame Disable pp: 0x5C => SmartFrame Trigger pp: 0x5D => SmartShoot Enable pp: 0x5E => SmartShoot Disable pp: 0x5F => Trun on OSD menu
	Set	8x 01 04 3F 01 pp FF	
	Recall	8x 01 04 3F 02 pp FF	

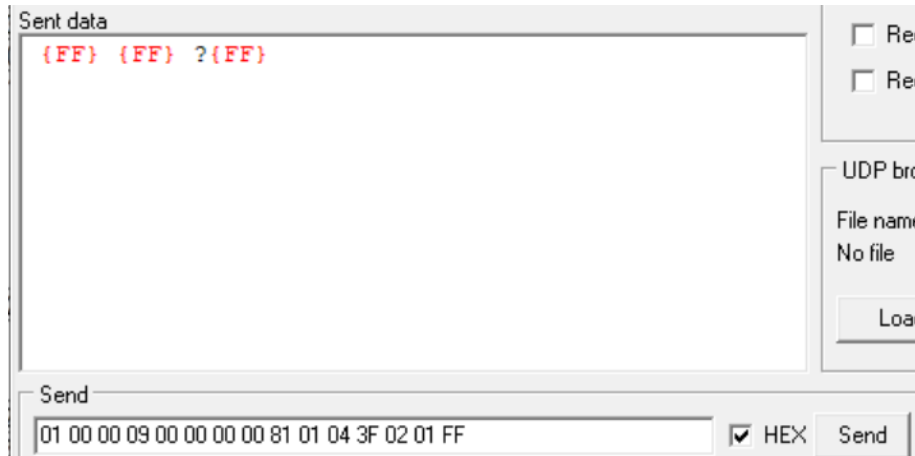

At this point, the camera should have moved to Preset #1 if it was configured.

8. If the commands being sent are NOT working, check the UDP ports.

In Windows open a “CMD” window and type in: **netstat -a -p udp**

```

UDP    192.168.0.121:52104    *:*
UDP    192.168.0.121:52381    *:*
: \Users\v002712>
UDP    0.0.0.0:5355          *:*
UDP    0.0.0.0:52381        *:*
UDP    0.0.0.0:52787        *:*
UDP    0.0.0.0:59446        *:*

```

Verify that Port 52381 is listed.

9. Verify/check your Network cable connections and how they are made, adhering to BICSI standards. Typically, 568B wiring is the most common for network connections.
10. If you are using a Managed network switch, verify ports are opened.
11. This concludes the basic Visca over IP verification testing for the AVer PTZ310/330 cameras.

AVer TR311 / TR311HN / TR313 / TR331 / TR333 Camera Setup

The AVer TR311/333(N) cameras offer exceptional optical quality up to 4K UHD 2160p/60 video standards, Quad Output, NDI HX support, SRT Ready, Advanced AI Auto Tracking, and PoE+ support.

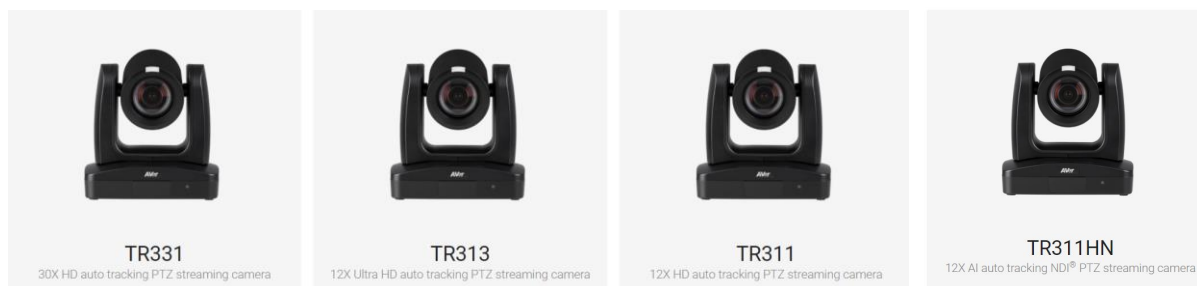

WebUI Network Connection:

- Once all the equipment is connected, network IP's have been assigned and configured, verify you can gain access to the TR311/333 Camera by typing in the IP address in a Chrome or IE-11 browser.

***Note:** Edge, Safari and other browsers are not supported.

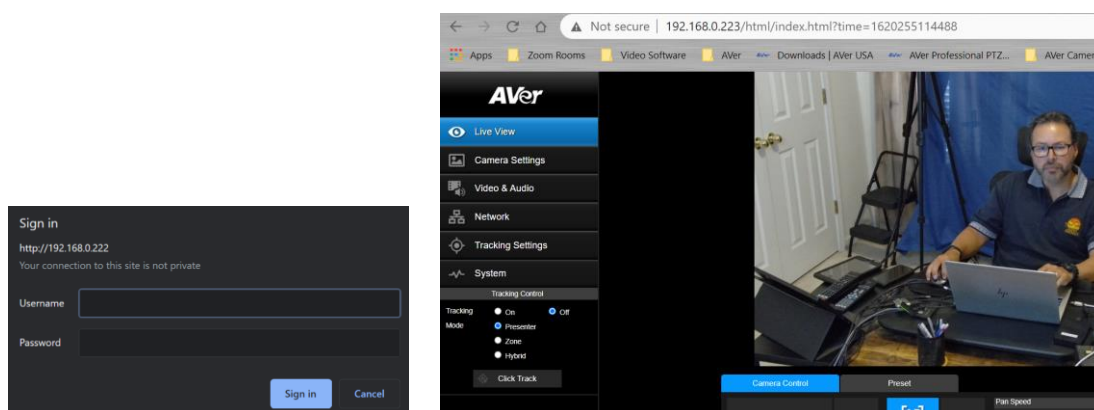

If this is the first time accessing the cameras WebUI, it will ask you for the default login credentials, which are: “admin” and “admin”

It will then ask you to change the default values, PLEASE write that information down, and then login with the NEW credentials.

Video and Audio Settings, Video Mode Available Outputs

Video Standard->	Stream Only (Various)	USB Only (Various)	USB + Streaming (Various)	NDI (1080p/60)
SDI Output	✓	✓	✓	✓
HDMI Output	✓	✓	✓	✓
USB Output	✗	✓	✓	✗
RTSP Output	✓	✗	✓	✓

WebUI Network Connection (continued):

2. Next, verify you can control the camera via the WebUI PTZ controls and can control the Presets, Save, Load functions.

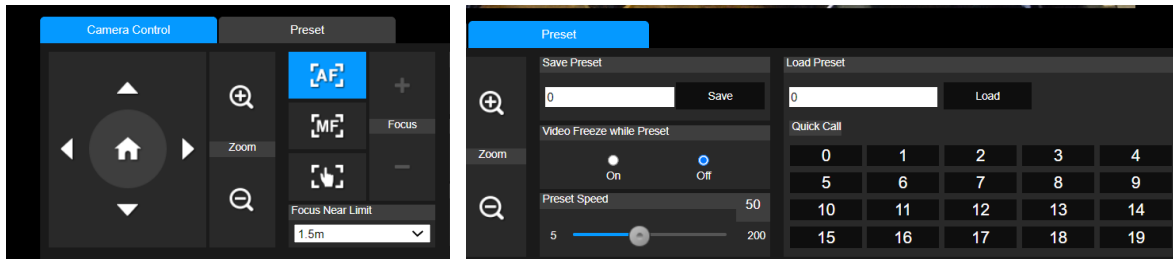

3. At this point you should have full control of the camera, ability to Save and Recall Presets, if you do NOT have control, most likely the control port has been disabled/blocked. Verify that port **52381** is open on the network.
4. Once the basic controls have been verified working from the WebUI of the camera, the next step is to verify the sending of Visca over IP commands work via the Hercules software.

Hercules Software Testing

In this next section we will discuss using the Hercules software in a very specific way to test the Visca over IP commands are being recognized by the AVer camera.

1. Open the Hercules software and select the UDP tab.

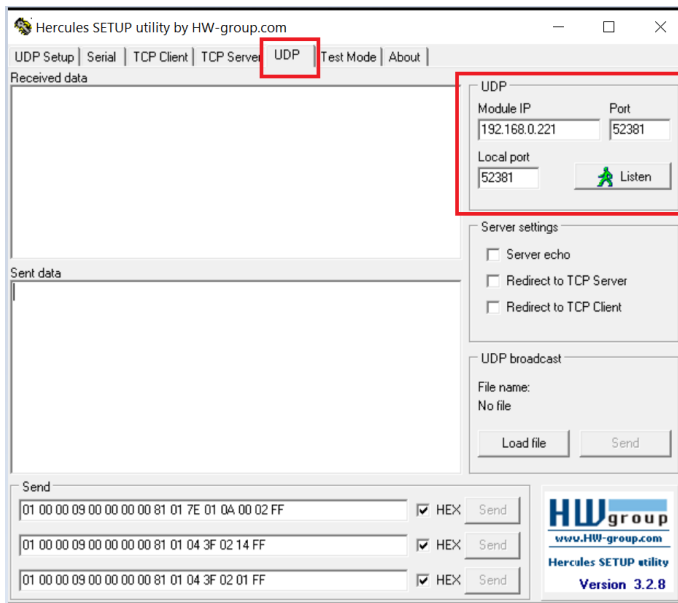

2. Next, enter the IP address of the camera as well as the Local/Port number 52381.
3. Next, select “Listen”, you should see a green message appear, “UDP socket created”.



4. Next, we now want to send a basic command to the camera via Visca over IP. For a complete list of commands, refer to the TR310/311HN/313/331/333 Control Codes document.

<https://www.averusa.com/pro-av/support/> look in the “Download” section.

In this example we will send a **Power Off** command to the camera.

01 00 00 09 00 00 00 00 81 01 04 00 03 FF

Command Set	Command	Command Packet	Comments
CAM_Power	On	8x 01 04 00 02 FF	Power ON/OFF
	Off	8x 01 04 00 03 FF	

Hercules Software Testing (continued)



5. Sending the **Power Off** command is pretty instant, the camera “may” go to a preset before powering off, if it is configured that way, the end result should be that the camera has an “Orange” LED on the front now and no video output.

6. Next, let us send a **Power On** command.

01 00 00 09 00 00 00 00 81 01 04 00 02 FF



The Orange LED should now start to blink, then the Power Up routine kicks in. The TR311/333 camera will take about 1 minute to completely boot up.

7. Next, let us test the **Presets, Recall Preset #1**

01 00 00 09 00 00 00 00 81 01 04 3F 02 01 FF

CAM_Preset	Reset	8x 01 04 3F 00 pp FF	pp: Preset Number 0x00-0xFF
	Set	8x 01 04 3F 01 pp FF	
	Recall	8x 01 04 3F 02 pp FF	



At this point, the camera should have moved to Preset #1 if it was configured.

Hercules Software Testing (continued)

Switch Command, to “switch” who the camera is tracking, 2 people in the shot



Tracking Enable



Tracking Disable

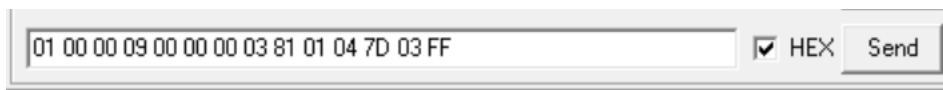

8. If the commands being sent are NOT working, check the UDP ports.

In Windows, open a “CMD” window and type in: **netstat -a -p udp**

```
UDP    192.168.0.121:52104    *:*
UDP    192.168.0.121:52381    *:*
:\Users\v002712>
UDP    0.0.0.0:5355          *:*
UDP    0.0.0.0:52381        *:*
UDP    0.0.0.0:52787        *:*
UDP    0.0.0.0:59446        *:*
```

Verify that Port 52381 is listed.

9. Verify/check your Network cable connections and how they are made, adhering to BICSI standards. Typically, 568B wiring is the most common for network connections.
10. If you are using a Managed network switch, verify ports are opened.
11. This concludes the basic Visca over IP verification testing for the AVer TR311/333 cameras.

AVer TR530 / TR320 Camera Setup

The AVer TR530 / TR320 cameras offer exceptional optical quality up to 1080p/60 video standards, Quad Output, (2) SDI Outputs, HDMI Output, Auto Tracking, and RTSP output.

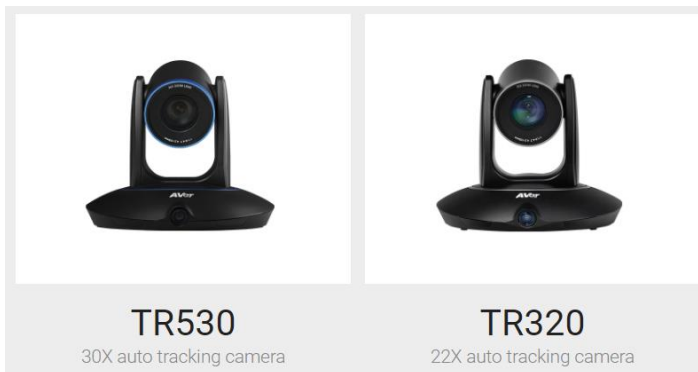

WebUI Network Connection:

1. Once all the equipment is connected, network IP's have been assigned and configured, verify you can gain access to the TR530/320 Camera by typing in the IP address in a Chrome or IE-11 browser.

***Note:** Edge, Safari and other browsers are not supported.

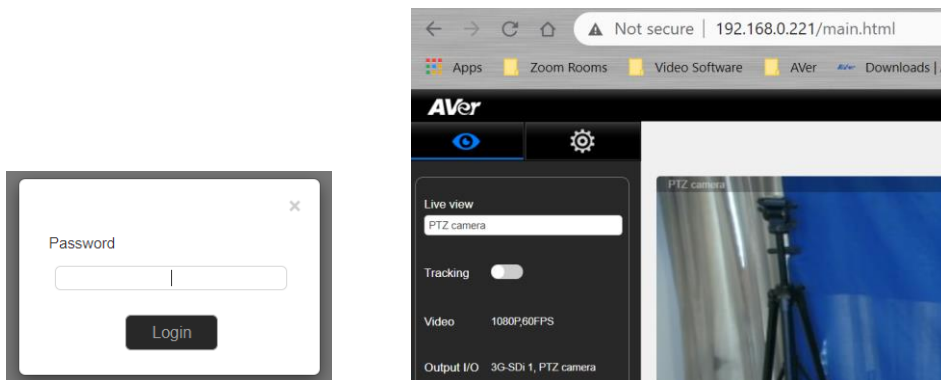

If this is the first time accessing the cameras WebUI, it will ask you for the default login password, which is: "admin"

It "may" ask you to change the default values, PLEASE write that information down, and then login with the NEW credentials.

2. Next, verify you can control the camera via the WebUI PTZ controls and can control the Presets, Save, Load functions.

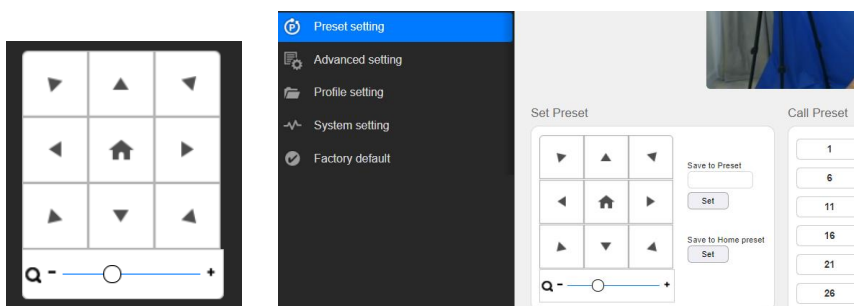

WebUI Network Connection (continued):

- Next, with the TR530 / TR320 camera we must verify that the camera has been configured for use with Visca Over IP, this is done by checking the *Advanced Setting* tab.

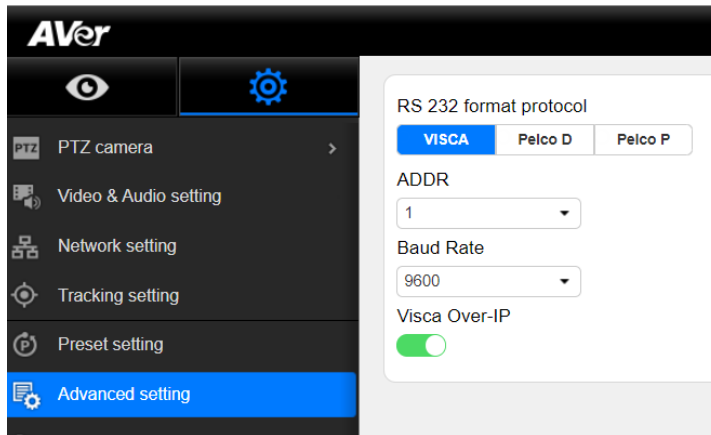

Make sure it has been ENABLED.

- Next, at this point you should have control of the camera, ability to Save and Recall Presets, if you do NOT have control, most likely the control port has been disabled/blocked. Verify that port **52381** is open on the network.
- Once the basic controls have been verified working from the WebUI of the camera, the next step is to verify that sending Visca over IP commands work via the Hercules software.

Hercules Software Testing

In this next section we will discuss using the Hercules software in a very specific way to test the Visca over IP commands are being recognized by the AVer camera.

1. Open the Hercules software and select the UDP tab.

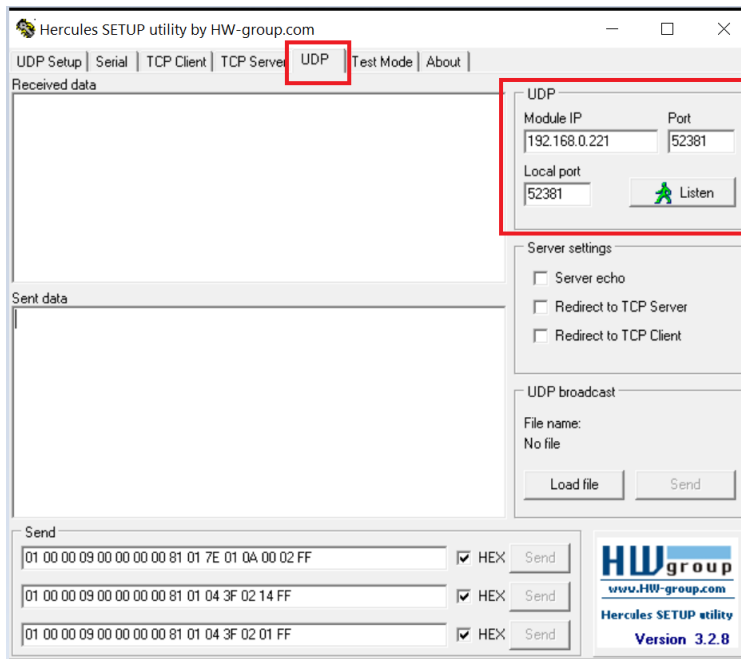

2. Next, enter the IP address of the camera as well as the Port number 52381.
3. Next, select “Listen”, you should see a green message appear, “UDP socket created”.

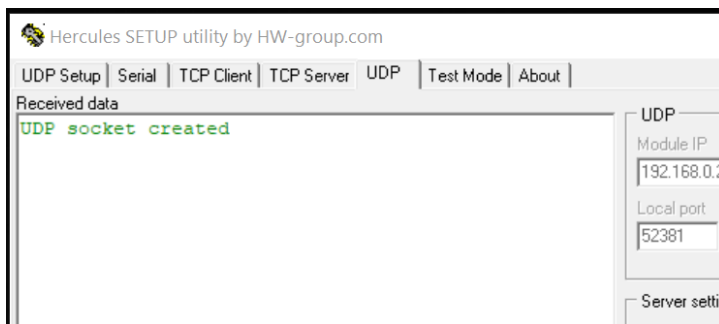

4. Next, we now want to send a basic command to the camera via Visca over IP. For a complete list of commands, refer to the TR530 / TR320 Control Codes document. <https://www.averusa.com/pro-av/support/> look in the “Download” section.

NOTE:

In the previous camera examples, we showed Power On/OFF, the TR530/320 camera does NOT support the Power ON command via Visca OVER IP. It does; however, work when connected via RS-232.

CAM_Power	On	8x 01 04 00 02 FF	*RS-232 support, over IP not support
	Off	8x 01 04 00 03 FF	

Hercules Software Testing (continued)

In this example we will send a **Camera Menu** command to the camera.

01 00 00 09 00 00 00 00 81 01 06 06 10 FF

CAM_Menu	recall	8x 01 04 3F 02 YY FF	Display ON/OFF
----------	--------	----------------------	----------------

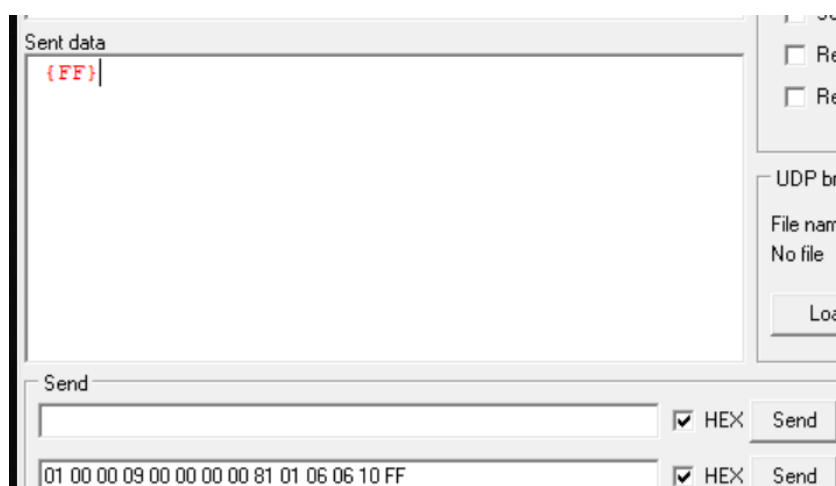

5. You should see the OSD camera Menu display on the HDMI/SDI output of the camera.
6. Sending the command again will then remove the OSD camera Menu.
7. Next, let us test the **Presets, Recall Preset #1**

01 00 00 09 00 00 00 00 81 01 04 3F 02 01 FF

CAM_Preset	reset	8x 01 04 3F 00 YY FF	YY = preset num(0-0x7F)
	set	8x 01 04 3F 01 YY FF	
	recall	8x 01 04 3F 02 YY FF	



At this point, the camera should have moved to Preset #1 if it was configured.

Hercules Software Testing (continued)

8. If the commands being sent are NOT working, check the UDP ports.

In Windows, open a "CMD" window and type in: **netstat -a -p udp**

```
UDP    192.168.0.121:52104    *:*
UDP    192.168.0.121:52381    *:*
:\Users\v002712>
UDP    0.0.0.0:5355          *:*
UDP    0.0.0.0:52381        *:*
UDP    0.0.0.0:52787        *:*
UDP    0.0.0.0:59446        *:*
```

Verify that Port 52381 is listed.

9. Verify/check your Network cable connections and how they are made adhering to BICSI standards. Typically, 568B wiring is the most common for network connections.
10. If you are using a Managed network switch, verify ports are opened.
11. This concludes the basic Visca over IP verification testing for the AVer PTZ310/330 cameras.

Crestron Example:

I had captured some Crestron control line syntax from another project, they were using Toolbox, this example shows Recalling Preset 5 on a TR530 camera.

```
User set CAM1_Preset5_tp to Press
CAM1_Preset5_tp          1
CAM1_Preset4_fb         0
CAM1_Preset5_fb         1
CAM_Preset4_fb          0
CAM_Preset5_fb          1
User set CAM1_Preset5_tp to Release
CAM1_Preset5_tp         0
CAM1_tx$                \x81\x01\x04?\x02\x04\xff
//CAM1_rx$              \x90AA
//CAM1_rx$              \xFF\x90Q
//CAM1_rx$              Q\xff
```

AVer Pro-AV RS-232 Control

Using the RS-232 and RS-422 control protocol offers the ability to send several different control commands over a dedicated control cable without the need to be concerned about Network firewalls, Ports used, or adding additional equipment like a network switch and Cat5E cabling.

With the RS232/RS422 serial connection, there are different protocols that can be used, below is a summary of the protocols.

VISCA: Up to 7 cameras can be addressed.

Pelco-P: Up to 32 cameras can be addressed.

Pelco-D: Up to 256 cameras can be addressed, (Address 0-255).

VISCA over IP: Up to 256 cameras can be addressed on the same network subnet.

The AVer **CL01** Camera controller can control up to 255 separate cameras on the same subnet using the Visca over IP protocol. Looking at the information above, using VISCA control, we can only control up to 7 cameras.

AVer has high quality image Cameras (TR311 / TR530 / PTZ330) that will integrate with these workflows for peak performance and ease of use. We will show the configuration process for the PTZ310/330, TR310/333, and TR530/320 Cameras using the Visca protocol.

There are several 3rd party controllers available that integrate with the AVer Pro-AV cameras, Crestron, Extron, QSC, Altona, RTI, to name a few. In this document we will discuss how to test the basic controls via software should there be an issue where the before mentioned controllers are not working as expected.



There are some pre-requisites for this to happen, see below.

Hercules Software

In order to verify “RS232 control” connectivity and control at a basic level, there is a “free” software available (Windows) to test the Visca-RS232 command strings. This is a valuable tool to “bypass” any hardware issues or programming issues from the devices being used.

It can be found here:

<https://www.hw-group.com/software/hercules-setup-utility>

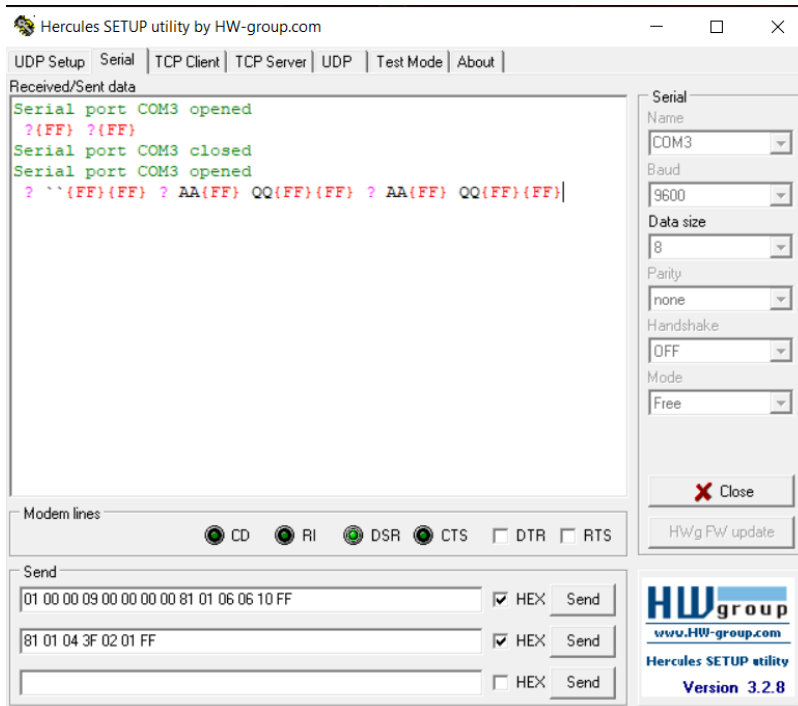

RS-232 Adaptor

If not already in your toolkit, purchase an RS-232 (9-Pin) to USB cable, it will be needed to test the RS-232 connection and commands.

[USB to Serial Adaptor](#)



Once connected, it should show up in your “Device Manager” and have a COM Port associated with it, i.e., COM2.

PTZ310 / PTZ330 RS-232 Connection

The AVer cameras can be connected in one of several different ways, one of those is to connect the cameras via a dedicated control cable.

Here is a typical camera RS-232 connection diagram.



For the **AVer CL01** to communicate to the cameras via Visca, set the camera Protocol to Visca and configure the correct Address of the camera via the **CL01 Sub-Menu**, selectable via the CL01 menu.

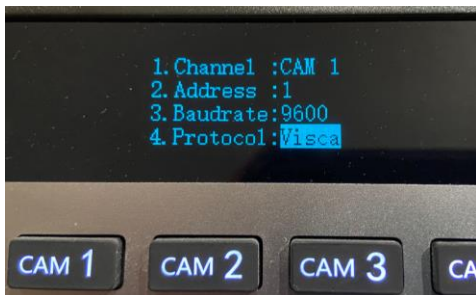

***Note:** For more detailed information on the CL01 setup and configuration, refer to the CL01 Camera Controller Connection Guide or User Manual.

<https://www.averusa.com/pro-av/support/>

AVer PTZ310 / PTZ330 RS-232 Camera Setup

The AVer PTZ310/330(N) offer exceptional optical quality up to 1080p/60 video standards, Quad Output, NDI support, SRT Ready, SmartShoot motion tracking, and PoE+ support.

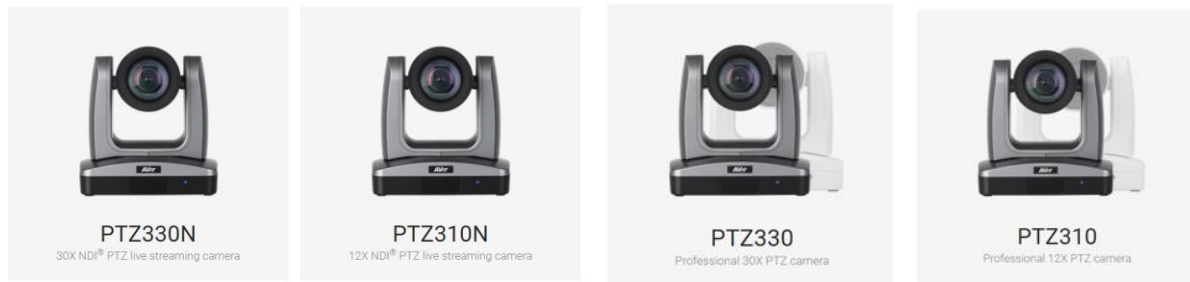

OSD Menu

Connect the HDMI or SDI output of the camera to a monitor to gain access to the OSD menu.

From here configure the camera to suite your environment, in this example we will be using Address #1 for setting up CAM 1.

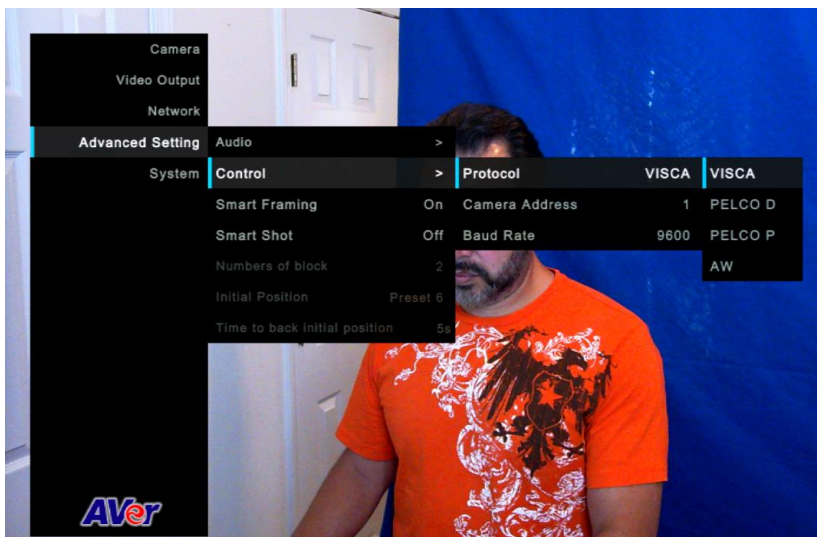

Verify the following via the OSD menu:

1. Control Type: RS232
2. Protocol: VISCA
3. Camera Address: 1, or whatever you want it to be (1 – 7).
4. Baude Rate: 9600, to start with.
5. If using a CL01 controller, match the CL01 with the camera settings.

RS-232 Connection:

***Note:** An RS232 Y-cable splitter (In/Out) is used to “daisy chain” the cameras together when connecting more than (1) camera.

Part Number: PTRSINOUT, [Din9-M to (2) Din8-F]

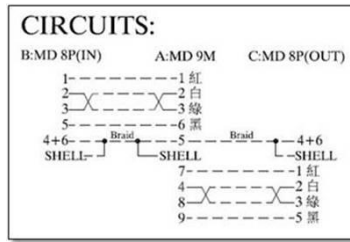

There is an RS232 accessories cable used with the PTZ cameras to connect its MiniDin9 connection using a Mini DIN8 to 9Pin DSub connector.

Part Number: PTDIN8PT1, Din8-M to 9-Pin DSub-F

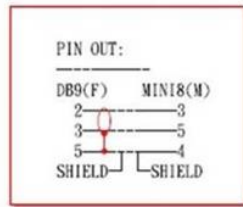
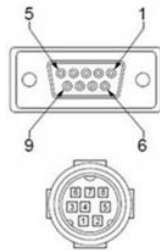

Below is a connection diagram of the AVer PTZ series of cameras connected via RS-232 cabling and a PC using a USB to Serial converter (DSub9-M).

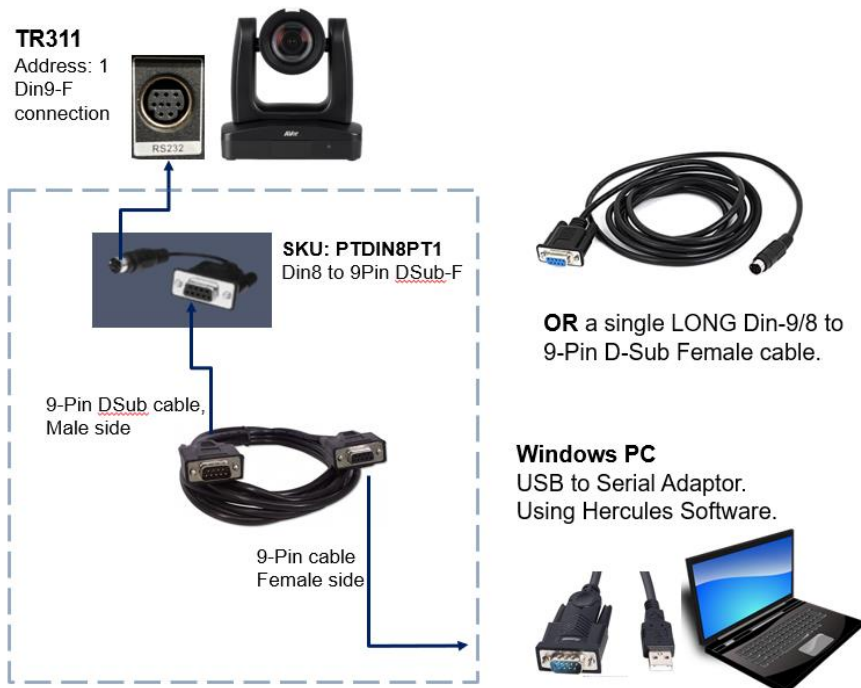

Hercules Software Testing

In this next section we will discuss using the Hercules software in a very specific way to test the Visca commands are being recognized by the AVer camera.

1. Open the Hercules software and select the Serial tab.

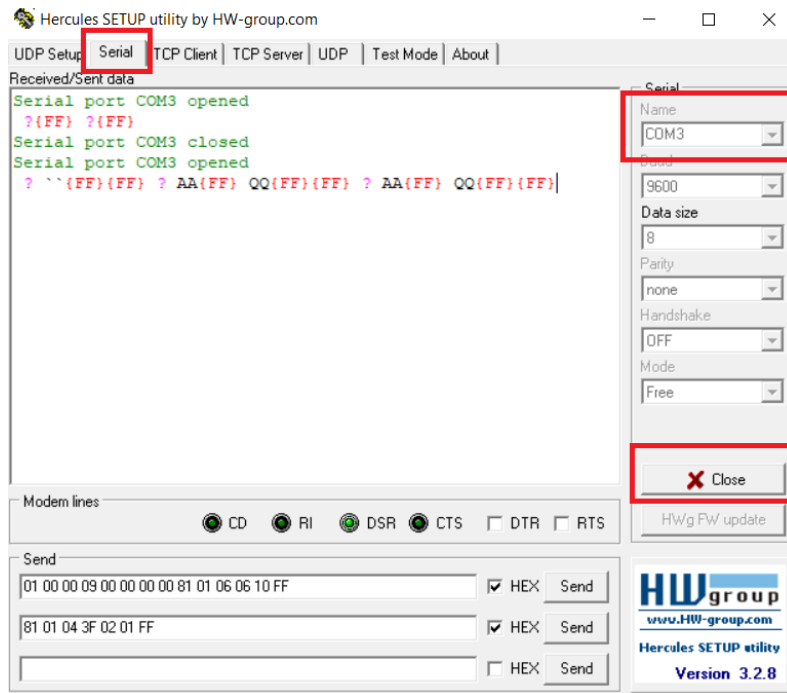

2. Next, configure the COM Port to match what is being used by your computer, i.e., COM3.
3. Next, select "Open", you should see a green message appear, "Serial Port socket created".



If the Serial or USB cable is not seen, then you will see an error message.

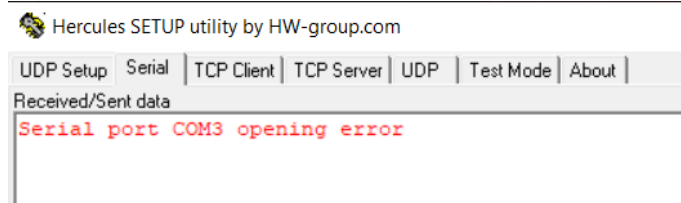

4. Next, we now want to send a basic command to the camera via Visca over IP. For a complete list of commands, refer to the PTZ310/PTZ330/PTZ330N Control Codes document.

<https://www.averusa.com/pro-av/support/> look in the "Download" section.

Hercules Software Testing RS-232 (continued)

5. In this example we will send a **Power Off** command to the camera.

81 01 04 00 03 FF

CAM_Power	On	8x 01 04 00 02 FF
	Off	8x 01 04 00 03 FF

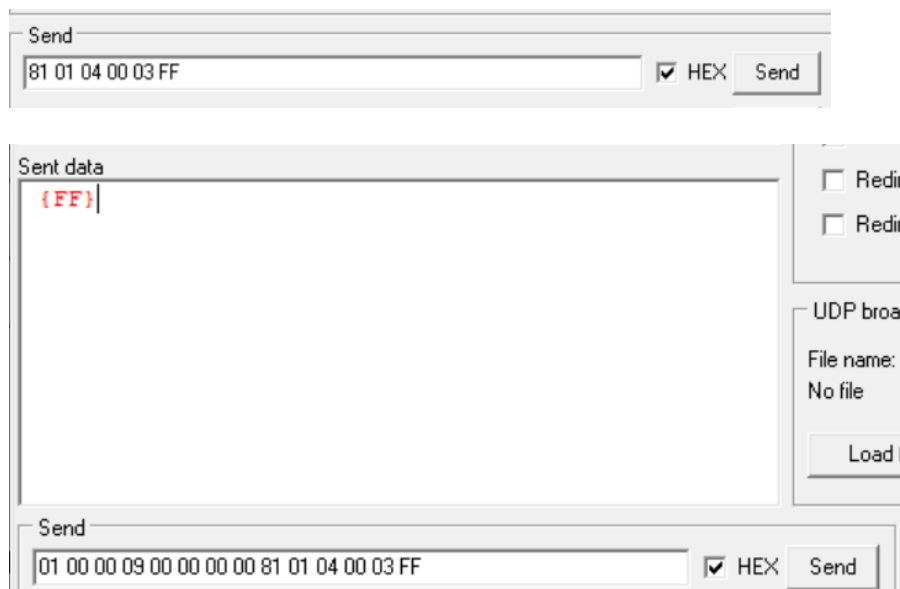

Sending the **Power Off** command is instant, the camera “may” go to a preset before powering off, if it is configured that way, the end result should be that the camera has an “Orange” LED on the front now and no video output.

6. Next, send a **Power On** command.

81 01 04 00 02 FF



The Orange LED should now start to blink for about 5 seconds, then the Power Up routine kicks in. The PTZ310/330 camera will take about 45 seconds to boot up.

7. Next, let us test the **Presets, Recall Preset #1**

01 00 00 09 00 00 00 00 81 01 04 3F 02 01 FF

CAM_Memory	Reset	8x 01 04 3F 00 pp FF	pp: 0x00 To 0xFF pp: 0x5A => SmartFrame Enable pp: 0x5B => SmartFrame Disable pp: 0x5C => SmartFrame Trigger pp: 0x5D => SmartShoot Enable pp: 0x5E => SmartShoot Disable pp: 0x5F => Trun on OSD menu
	Set	8x 01 04 3F 01 pp FF	
	Recall	8x 01 04 3F 02 pp FF	

Hercules Software Testing RS-232 (continued)

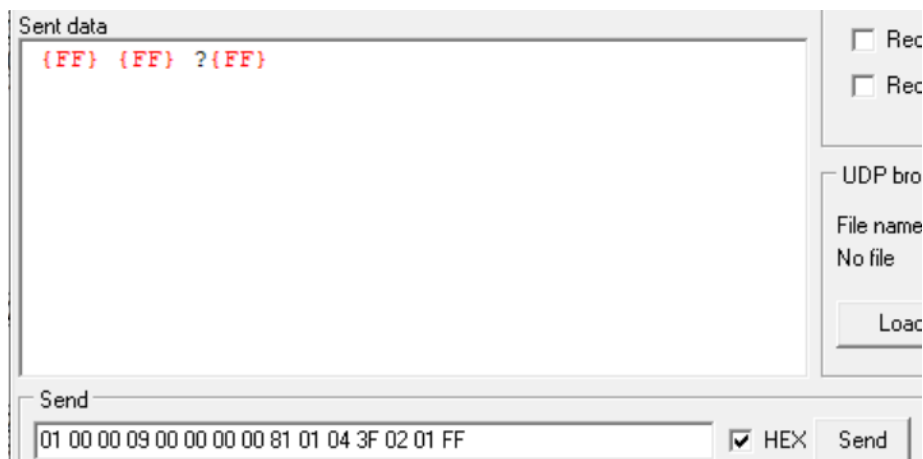

At this point, the camera should have moved to Preset #1 if it was configured.

8. If the commands being sent are NOT working, check the COM port setup.
 - Verify that the COM Port # listed in Windows is the one being used in Hercules.
 - Verify/check your cable connections and they are securely in place.
 - Verify camera is setup to use RS-232 protocol.

9. This concludes the basic Visca RS-232 verification testing for the AVer PTZ310/330 cameras.

AVer TR311 / TR311HN / TR313 / TR331 Camera Setup

The AVer TR311/333(N) cameras offer exceptional optical quality up to 4K UHD 2160p/60 video standards, Quad Output, NDI HX support, SRT Ready, Advanced AI Auto Tracking, and PoE+ support.

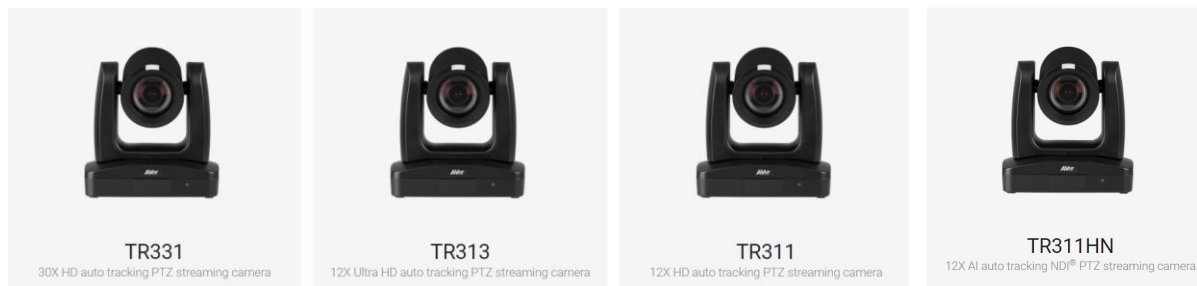

OSD Menu

Connect the HDMI or SDI output of the camera to a monitor to gain access to the OSD menu.

From here configure the camera to suite your environment, in this example we will be using Address #1 for setting up CAM 1.

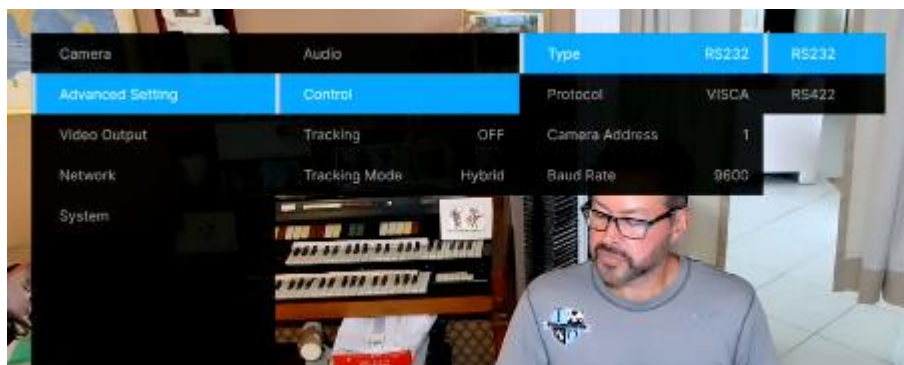

Verify the following via the OSD menu:

1. Control Type: RS232
2. Protocol: VISCA
3. Camera Address: 1, or whatever you want it to be (1 – 7).
4. Baude Rate: 9600, to start with.
5. If using a CL01 controller, match the CL01 with the camera settings.

RS-232 Connection:

***Note:** An RS232 Y-cable splitter (In/Out) is used to “daisy chain” the cameras together when connecting more than (1) camera to control.

Part Number: PTRSINOUT, [Din9-M to (2) Din8-F]

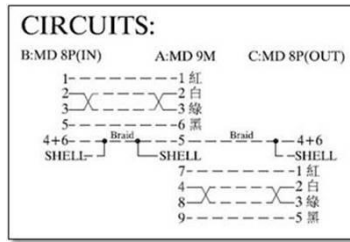

There is an RS232 accessories cable used with the PTZ cameras to connect its MiniDin9 connection using a Mini DIN8 to 9Pin DSub connector.

Part Number: PTDIN8PT1, Din8-M to 9Pin DSub-F

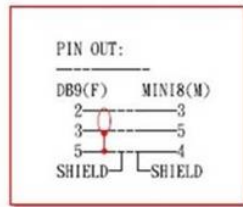
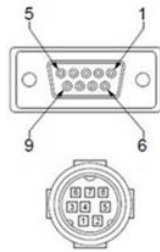

Below is a connection diagram of the AVer PTZ series of cameras connected via RS-232 cabling and a PC using a USB to Serial converter (DSub9-M).

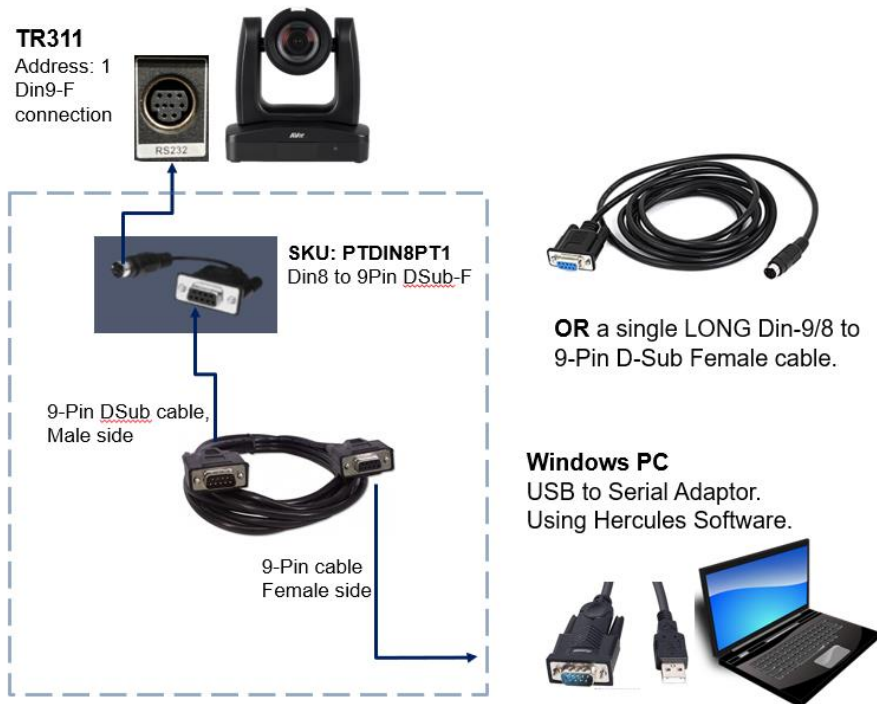

Hercules Software Testing RS-232

In this next section we will discuss using the Hercules software in a very specific way to test the Visca commands are being recognized by the AVer camera.

1. Open the Hercules software and select the Serial tab.

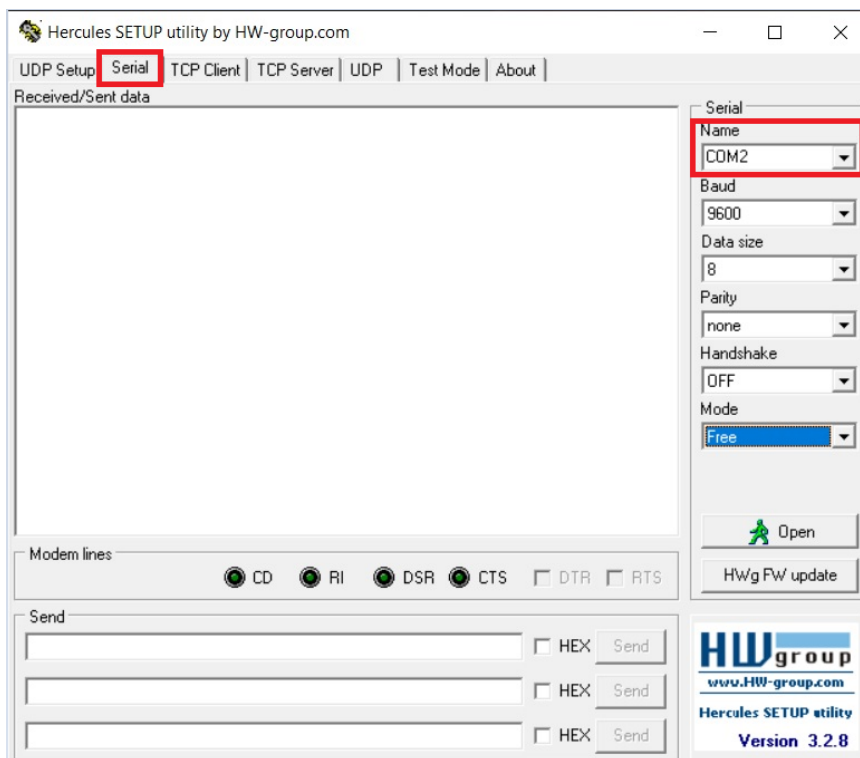

2. Next, configure the COM Port # to match what is being used by your computer, i.e., COM3.
3. Next, select "Open", you should see a green message appear, "Serial Port socket created".

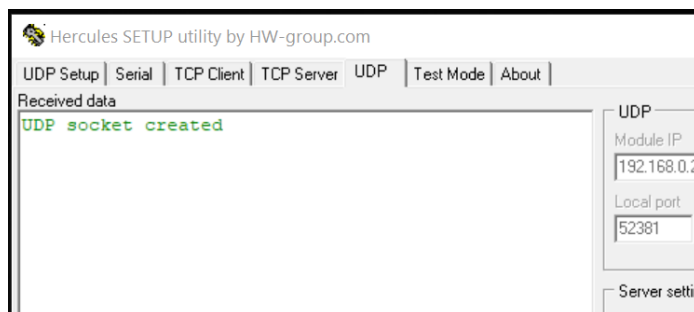

4. Next, we now want to send a basic command to the camera via Visca over IP.
For a complete list of commands, refer to the TR311/311HN/313/331/333 Control Codes document.

<https://www.averusa.com/pro-av/support/> look in the "Download" section.

Hercules Software Testing RS-232 (continued)

- In this example we will send a **Power Off** command to the camera.

81 01 04 00 03 FF



Command Set	Command	Command Packet	Comments
CAM_Power	On	8x 01 04 00 02 FF	Power ON/OFF
	Off	8x 01 04 00 03 FF	



Sending the **Power Off** command is instant, the camera “may” go to a preset before powering off, if it is configured that way, the end result should be that the camera has an “Orange” LED on the front now and no video output.

- Next, send a **Power On** command.

81 01 04 00 02 FF

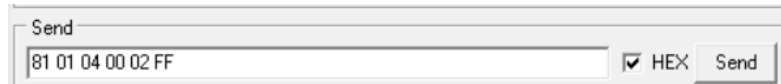

The Orange LED should now start to blink for about 5 seconds, then the Power Up routine kicks in. The TR311/331 cameras will take about 60 seconds to boot up completely.

- Next, let us test the **Presets, Recall Preset #1**

81 01 04 3F 02 01 FF

CAM_Memory	Reset	8x 01 04 3F 00 pp FF	pp: 0x00 To 0xFF pp: 0x5A => SmartFrame Enable pp: 0x5B => SmartFrame Disable pp: 0x5C => SmartFrame Trigger pp: 0x5D => SmartShoot Enable pp: 0x5E => SmartShoot Disable pp: 0x5F => Trun on OSD menu
	Set	8x 01 04 3F 01 pp FF	
	Recall	8x 01 04 3F 02 pp FF	

Hercules Software Testing RS-232 (continued)

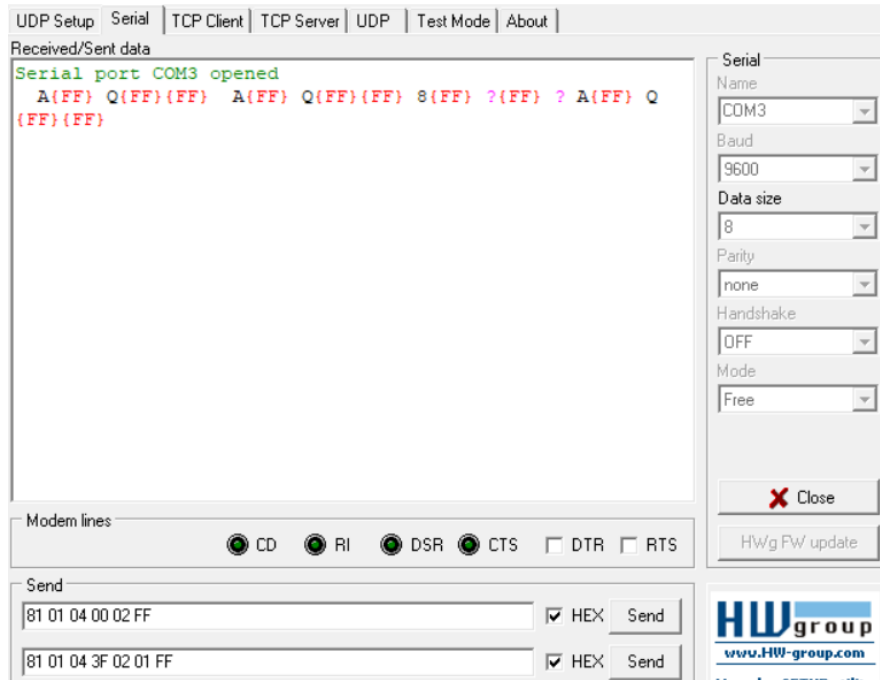

At this point, the camera should have moved to Preset #1 if it was configured.

8. Additional TR311/331 RS-232 commands to try:

Tracking Enable

81 01 04 7D 02 FF

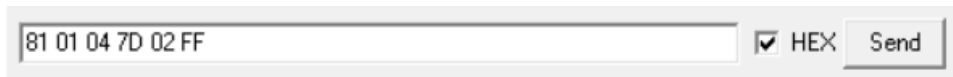

Switch Command, to “switch” who the camera is tracking, 2 people in the shot

81 01 04 3F 02 01 FF

Tracking Disable

81 01 04 7D 03 FF

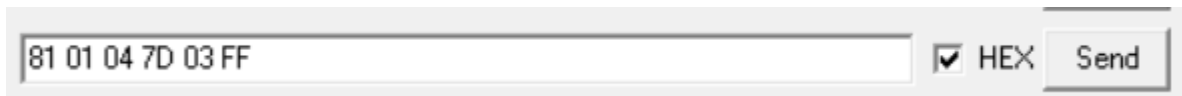

9. If the commands being sent are NOT working, check the COM port setup.

- Verify that the COM Port # listed in Windows is the one being used in Hercules.
- Verify/check your cable connections and they are securely in place.
- Verify TR311/331 camera is set to RS-232 control protocol.

10. This concludes the basic Visca RS-232 verification testing for the AVer TR311/331 cameras.

AVer TR530 / TR320 Camera Setup

The AVer TR530 / TR320 cameras offer exceptional optical quality up to 1080p/60 video standards, Quad Output, (2) SDI Outputs, HDMI Output, RTSP output, and Auto Tracking.

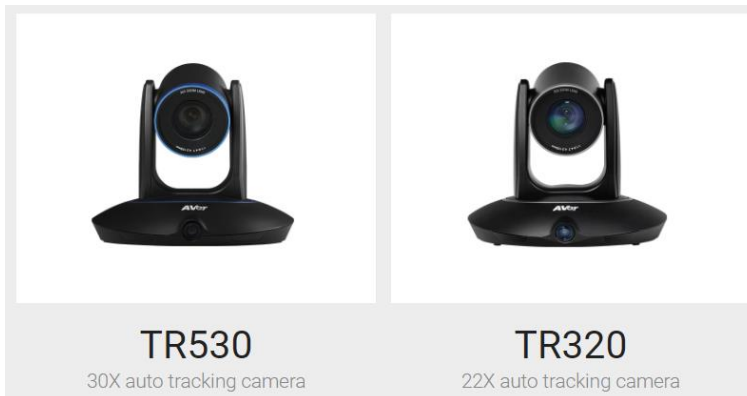

OSD Menu

Connect the HDMI or SDI output of the camera to a monitor to gain access to the OSD menu.

From here configure the camera to suite your environment, in this example we will be using Address #1 for setting up CAM 1.

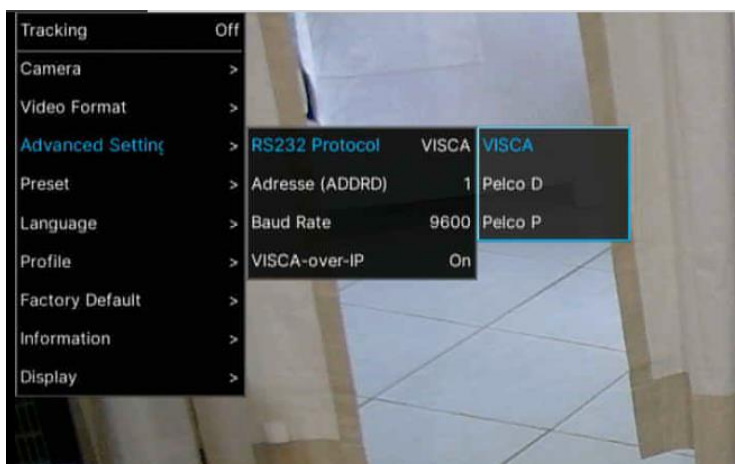

Verify the following via the OSD menu:

1. RS232 Protocol: VISCA
2. Address: 1, or whatever you want it to be (1 – 8).
4. Baude Rate: 9600, to start with.
5. If using a CL01 controller, match the CL01 with the camera settings.

TR530 / TR320 WebUI Network Connection

If the TR530 / TR320 camera is connected via the network, you can gain access to the camera's WebUI by typing in the IP address in a **Chrome** or **IE-11** browser.

***Note:** Edge, Safari, and other browsers are not supported.

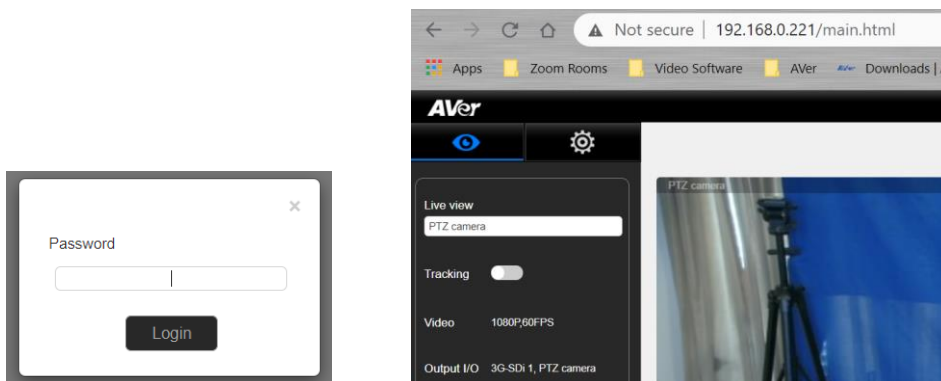

If this is the first time accessing the cameras WebUI, it will ask you for the default login password, which is: "admin"

It "may" ask you to change the default values, PLEASE write that information down, and then login with the NEW credentials.

1. Next, go to the Advanced settings, you can verify the control settings there as well.

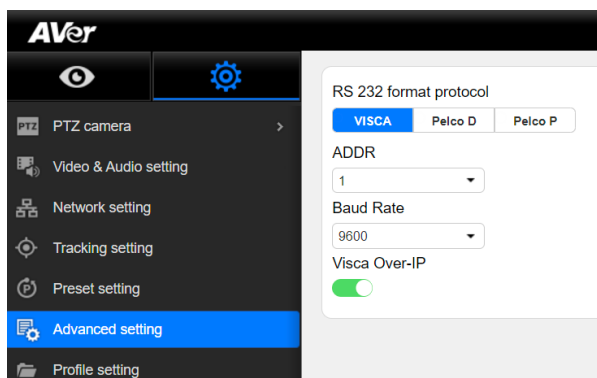

2. Once the basic controls have been verified working from the WebUI of the camera, the next step is to verify that sending RS-232 Visca commands via the Hercules software.

RS-232 Connection:

***Note:** An RS232 Y-cable splitter (In/Out) could be used to “daisy chain” the cameras together when connecting more than (1) camera to control, the pinouts would need to match and be verified.

AVer Pro-AV does not provide this cable, it would need to be purchased from another source.

Din6-M to (2) DIN6-F



There is an RS232 accessories cable used with the PTZ cameras to connect its MiniDin6 connection using a Mini DIN6 to 9Pin DSub-F connector.

Part Number: COMVCC232, Din6-M to 9Pin DSub-F



Below is a connection diagram of the AVer TR530/320 series of cameras connected via RS-232 cabling and a PC using a USB to Serial converter (DSub 9).



**TR530 / TR320 RS-232 Camera Control with PC
(1 Camera Setup)**



Hercules Software Testing RS-232

In this next section we will discuss using the Hercules software in a very specific way to test the Visca over IP commands are being recognized by the AVer camera.

1. Open the Hercules software and select the Serial tab.

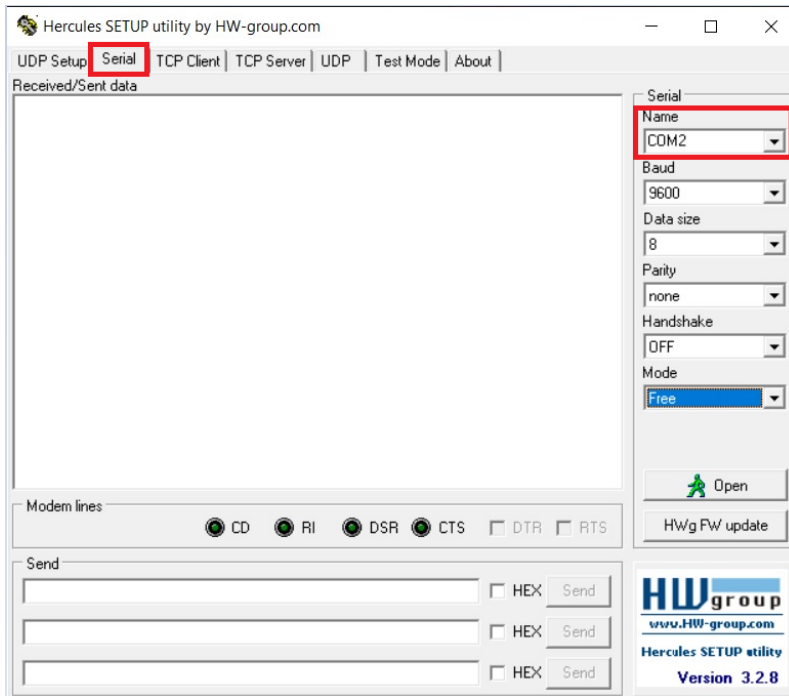

2. Next, configure the COM Port # to match what is being used by your computer, i.e., COM2.
3. Next, select “Open”, you should see a green message appear, “Serial Port opened”.



4. Next, we now want to send a basic command to the camera via Visca over IP. For a complete list of commands, refer to the TR530 / TR320 Control Codes document. <https://www.averusa.com/pro-av/support/> look in the “Download” section.

NOTE:

In the previous camera examples, we showed Power On/OFF, the TR530/320 camera does NOT support the Power ON command via Visca OVER IP. It does; however, work when connected via RS-232.

CAM_Power	On	8x 01 04 00 02 FF	*RS-232 support, over IP not support
	Off	8x 01 04 00 03 FF	

Hercules Software Testing RS-232 (continued)

- In this example we will send a **Camera Menu** command to the camera.

81 01 06 06 10 FF

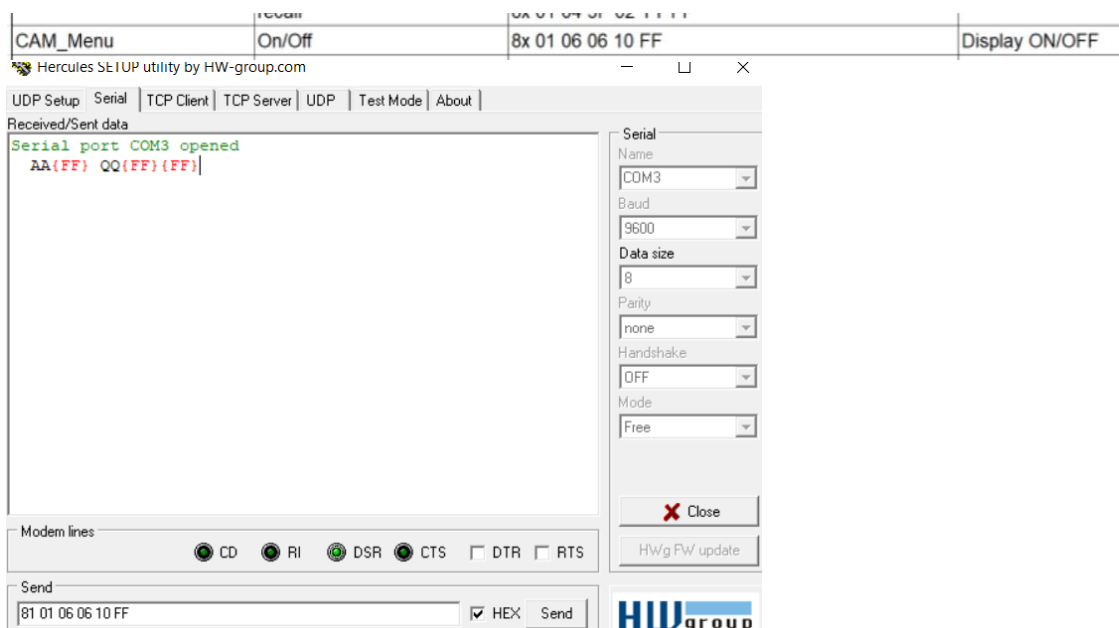

- You should see the OSD camera Menu display on the HDMI/SDI output of the camera.

- Sending the command again will then remove the OSD camera Menu.

- Next, let us test the **Presets, Recall Preset #1**

81 01 04 3F 02 01 FF

CAM_Preset	reset	8x 01 04 3F 00 YY FF	YY = preset num(0-0x7F)
	set	8x 01 04 3F 01 YY FF	
	recall	8x 01 04 3F 02 YY FF	

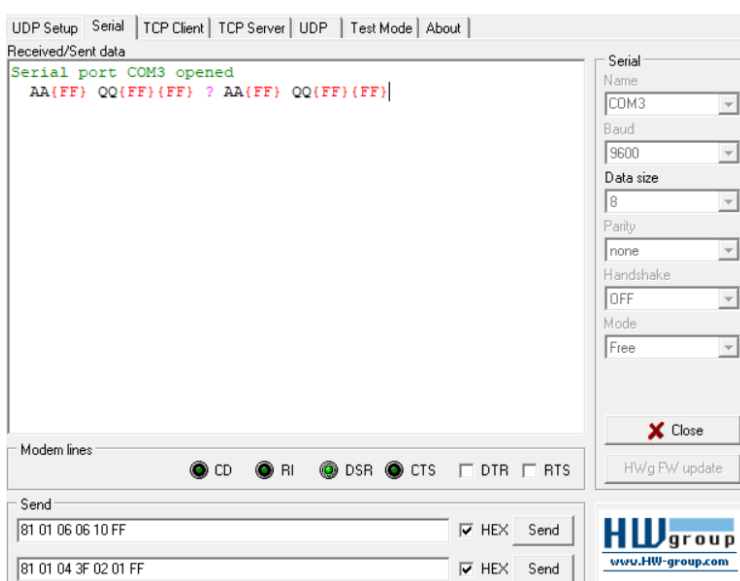

At this point, the camera should have moved to Preset #1 if it was configured.

Hercules Software Testing RS-232 (continued)

9. Next, let us test the **Power OFF** command

81 01 04 00 03 FF

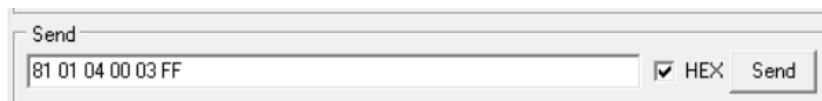

CAM_Power	On	8x 01 04 00 02 FF	*RS-232 support, over IP not support
	Off	8x 01 04 00 03 FF	

The TR530/320 can take up to 10seconds before you see the LED light begin to blink, then turn Red.

10. Next, let us test the **Power ON** command

81 01 04 00 02 FF

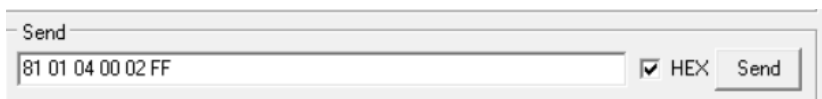

The Power On command is pretty instant; the front LED should turn blue.

The TR530/320 camera takes about 60 seconds to fully boot up.

11. If the commands being sent are NOT working, check the COM port setup.

- Verify that the COM Port # listed in Windows is the one being used in Hercules.
- Verify/check your cable connections and they are securely in place.

12. This concludes the basic Visca RS-232 verification testing for the AVer TR530/320 cameras.

AVer CL01 Camera Controller Pinout RS-232

9pin DSub-M

Pin 2 – RXD

Pin 3 – TXD

Pin 5 – GND/Shield



RS-422 AVer TR311 to TR331 and PTZ310 / PTZ330 Camera Setup

The AVer cameras can also be controlled via RS-422, the following will cover the RS-422 hardware connections. The VISCA tests will be the same as mentioned before using the Hercules software.



OSD Menu

Connect the HDMI or SDI output of the camera to a monitor to gain access to the OSD menu.

From here configure the camera to suite your environment, in this example we will be using Address #1 for setting up CAM 1.

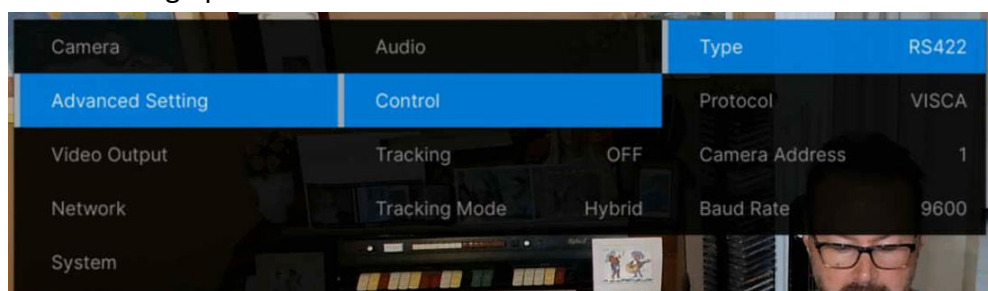

Verify the following via the OSD menu:

1. Control Type: RS422
2. Protocol: VISCA
3. Camera Address: 1, or whatever you want it to be (1 – 7).
4. Baude Rate: 9600, to start with.
5. When using a CL01 controller, match the CL01 with the camera settings.

CL01 RS422 Connection



RS-422 Connection:

For the RS-422 connection to the camera, an RJ-45 cable is needed using Cat5E cable, 8-Pin Male connector on the camera side, and open wires on the CL01 side.

Below is a connection diagram of the AVer TR311 and PTZ310 series of cameras connected via RS-422 cabling and the AVer CL01 4-pin Phoenix connector.

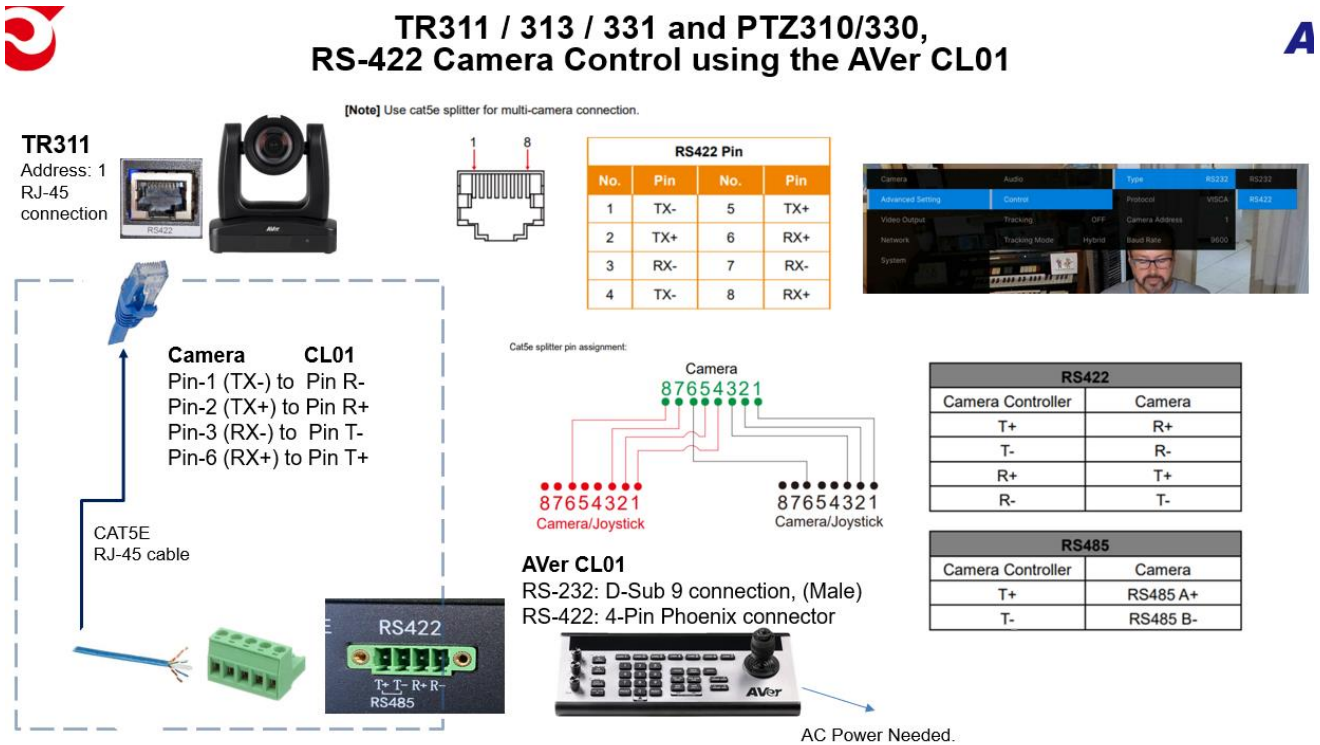

Multiple Camera RS-422 Connection

■ RS422

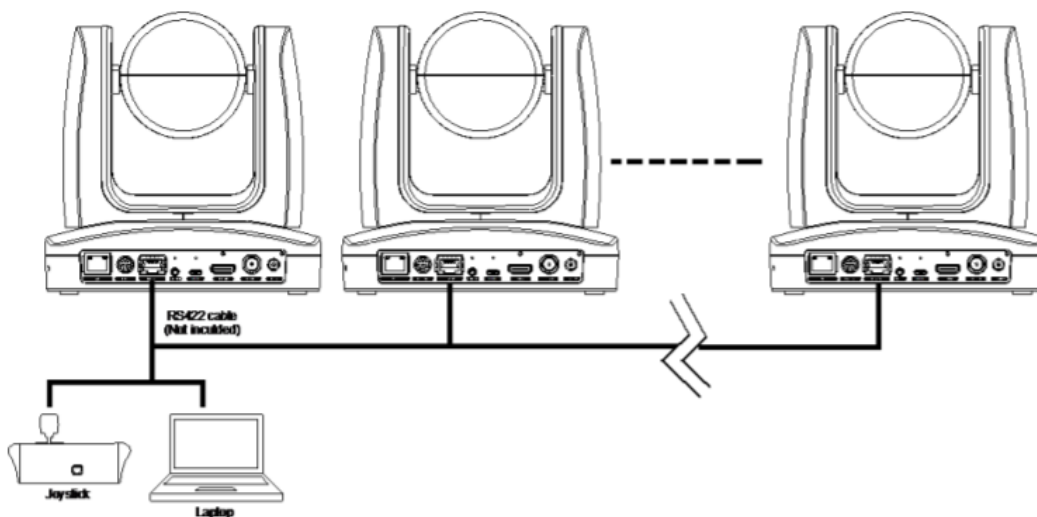

Multiple Camera RS-422 Connection (continued)

[Note] Use cat5e splitter for multi-camera connection.

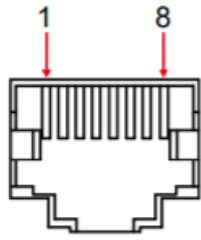

RS422 Pin			
No.	Pin	No.	Pin
1	TX-	5	TX+
2	TX+	6	RX+
3	RX-	7	RX-
4	TX-	8	RX+

Cat5e splitter pin assignment:

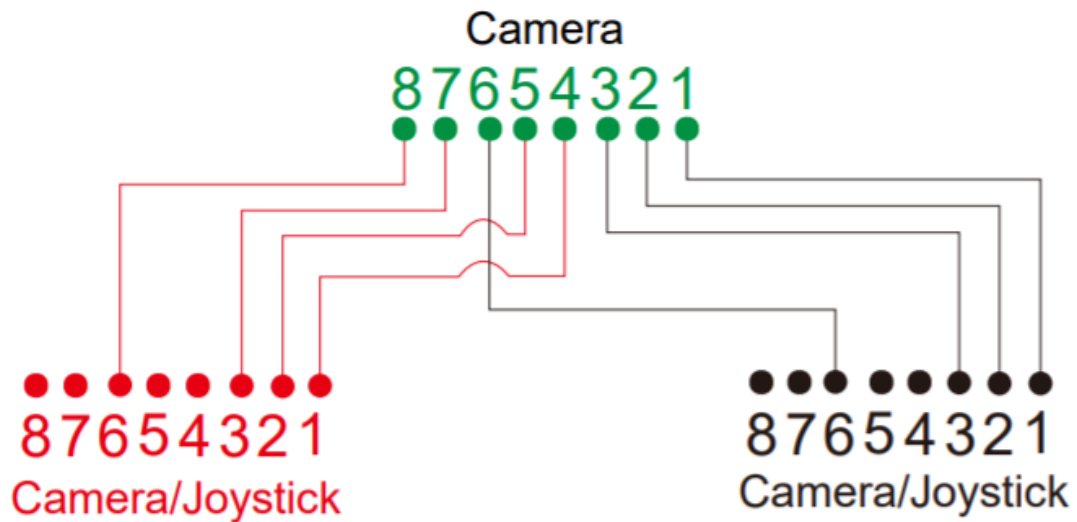

AVer Pro-AV Cable Drawings

AVer PTZ and TR311 Camera RS-232 Cable Pinout Definitions

SKU: PTRSINOUT

MiniDin9-M to (2) MiniDin8-F



SKU: PTDIN8PT1

MiniDin8-M to 9Pin DSub-F

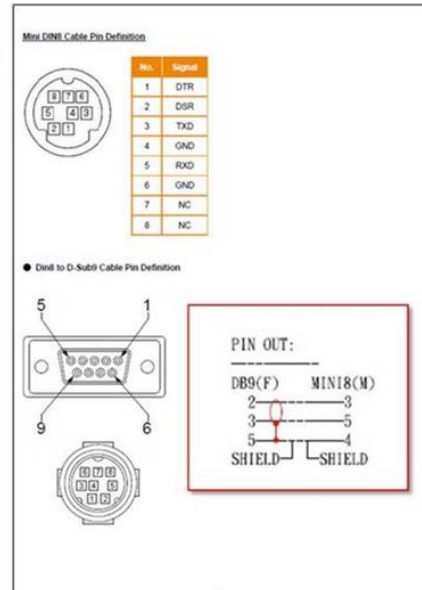
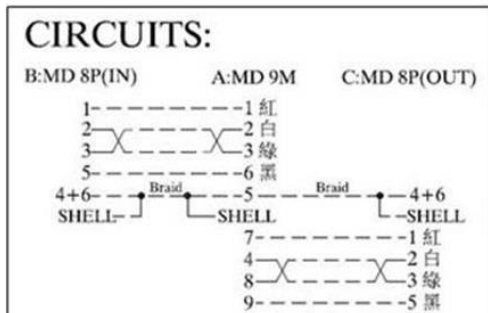

AVer TR530 / TR320 Camera RS-232 Cable Pinout Definitions

SKU: COMVCC232

Din6-M to DSub9-F cable



RS232 Pin Definition

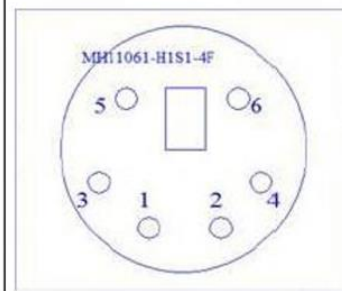

Pin	Definition
1	RS232_DTR
2	RS232_DSR
3	N.C.
4	RS232_TXD
5	GND
6	RS232_RXD

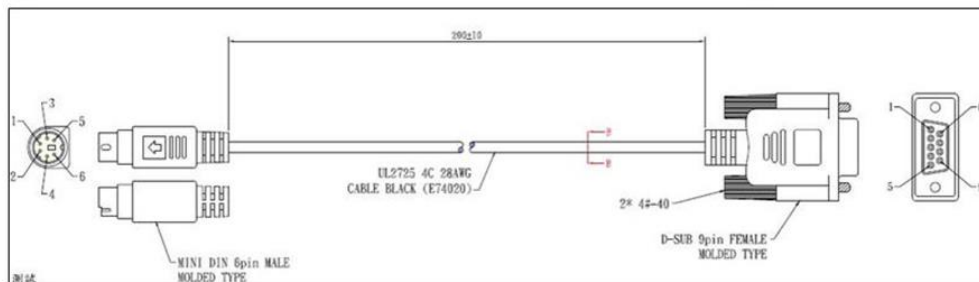

RS-232 Pro-AV Camera Control Diagrams



TR311 / 313 / 331 and PTZ310/330, RS-232 Camera Control using a PC

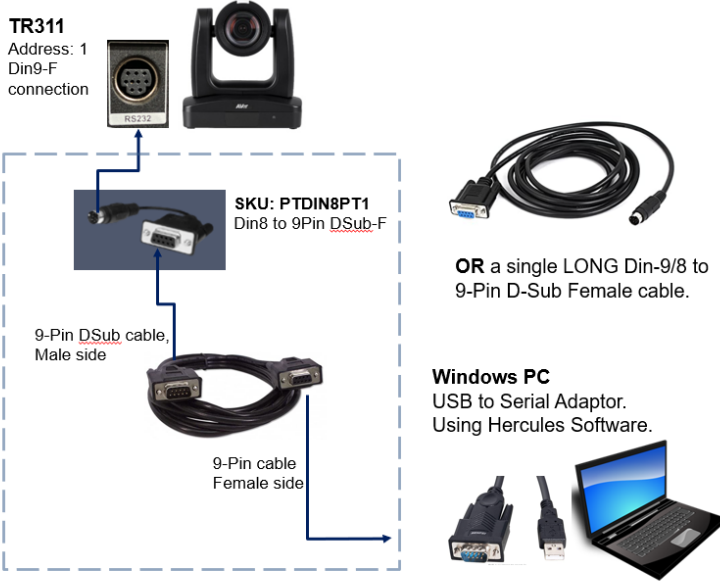

● RS232 Port Pin Definition

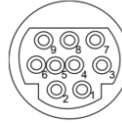

Function	Mini DIN9 PIN #	I/O Type	Signal	Description
VISCA IN	1	Output	DTR	Data Terminal Ready
	2	Input	DSR	Data Set Ready
	3	Output	TXD	Transmit Data
	6	Input	RXD	Receiver Data
VISCA OUT	7	Output	DTR	Data Terminal Ready
	4	Input	DSR	Data Set Ready
	8	Output	TXD	Transmit Data
	9	Input	RXD	Receiver Data
	5	---	---	Not connect

19



PTZ310 / PTZ330, RS-232 Camera Control (2) Cam Setup

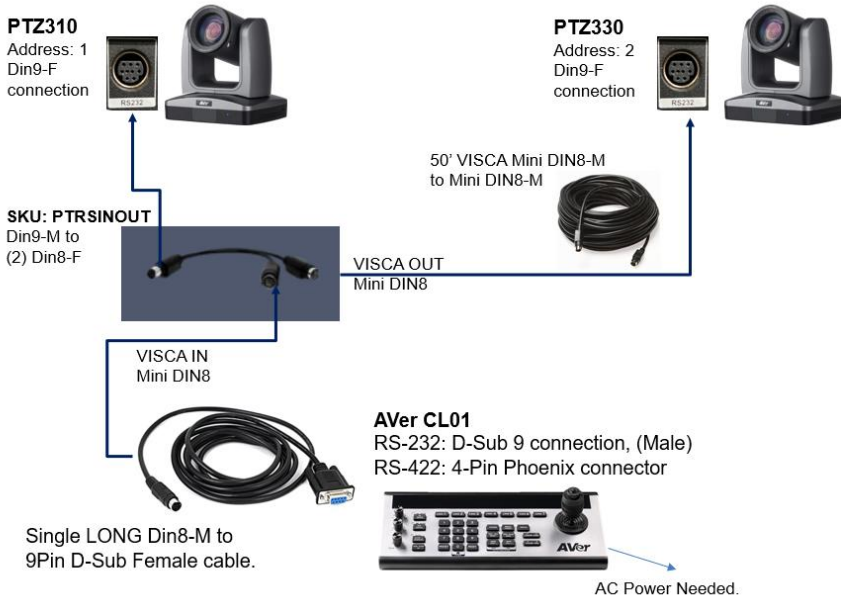

PTRSINOUT cable pinout

● RS232 Port Pin definition

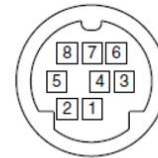

RS232 Pin	
No.	Pin
1	DTR
2	DSR
3	TXD
4	GND
5	RXD
6	GND
7	NC
8	NC

22

RS-232 Pro-AV Camera Control Diagrams (continued)



TR311 / 313 / 331, RS-232 Camera Control (2 or more) Cam Setup



20



TR530 / TR320 RS-232 Camera Control with CL01 (1 Camera Setup)

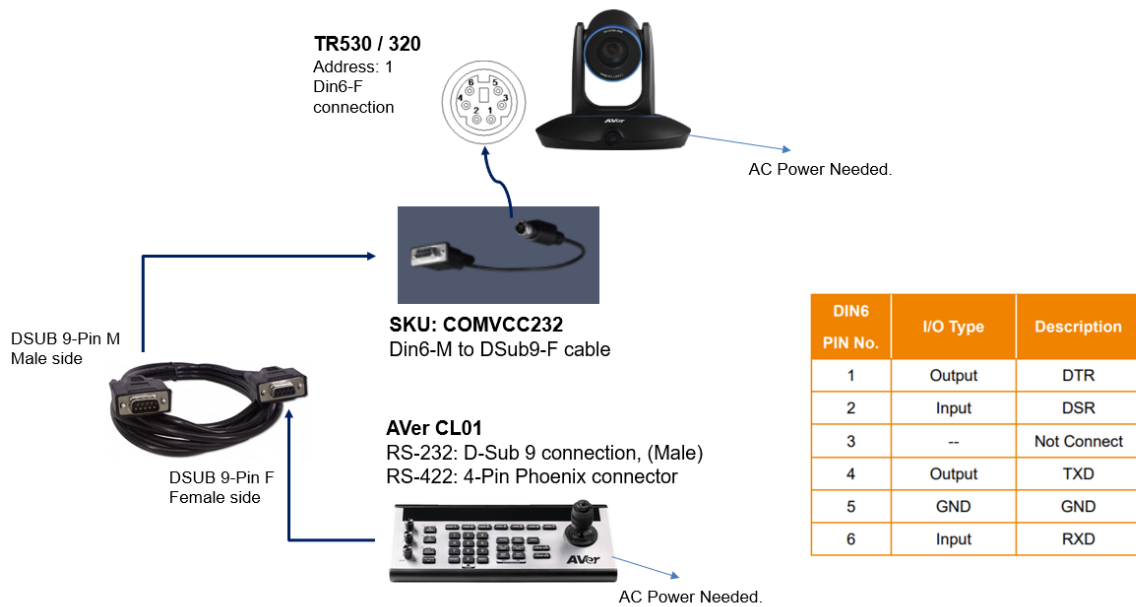

25

VISCA over IP Packets

If you are using a 3rd party controller, Crestron, Extron, QSC, Altona, etc. verify the command structure you are using is correct for BOTH the controller and the camera.

VISCA over IP commands need to be sent in full packet order:

Packet header + VISCA command.

Let's take **PT_Up** as an example.

The full command should be **01 00 00 09 00 00 00 00 81 01 06 01 08 08 03 01 ff**.

RED part of command is for VISCA over IP packet header. **BLUE** part of command is for VISCA command.

Also, after any pan tilt movement command is sent, it needs to send **PT_Stop** command to stop movement, which should be **01 00 00 09 00 00 00 00 81 01 06 01 08 08 03 03 ff**.

For the VISCA over IP header, the 3rd & 4th bytes of the header are important.

They indicate length of payload (VISCA command).

At this point, the value could be varying depending on what VISCA command is sent.

For example:

Inquiry (listed as "info") - 01 00 00 **05** 00 00 00 00 **81 09 00 02 FF**

Settings (listed as "framing") - 01 00 00 **07** 00 00 00 00 **81 01 04 7D 00 00 FF**

Command (movements) - 01 00 00 **09** 00 00 00 00 **81 01 06 01 08 08 03 01 FF**

