

OWI INC

USER MANUAL: Model: AMP-BT2SIC5 / AMP-BT2SIC6

Speaker Combination Models

AMP-BT2SIC51 / AMP-BT2SIC52 / AMP-BT2SIC54
AMP-BT2SIC51SVC / AMP-BT2SIC52SVC / AMP-BT2SIC54SVC
AMP-BT2SIC61 / AMP-BT2SIC62 / AMP-BT2SIC64
AMP-BT2SIC61SVC / AMP-BT2SIC62SVC / AMP-BT2SIC64SVC



OWI Incorporated
17141 Kingsview Ave. Carson CA 90746-1207 USA
Tel. 310-515-1900 Fax 310-515-1606

info@owi-inc.com
www.owi-inc.com
Technical Support 310-515-1900

OWI User Manual: Model AMP-BT2SIC5 / AMP-BT2SIC6 Speaker Amplifier
Model AMP-BT2SIC5 / AMP-BT2SIC6 Speaker Amplifier

PROPRIETARY NOTICE

The OWI Inc. product information and design disclosed herein were originated by and are the property of OWI Inc. OWI Inc. reserves all patent, proprietary design, manufacturing, reproduction, use and sales rights thereto, and to any article disclosed therein, except to the extent right(s) are expressly granted to others.

COPYRIGHT NOTICE

This manual is Copyright 2014 by OWI Inc. All rights reserved. Reproduction in whole or in part without written prior permission from OWI, Inc. is prohibited.

UNPACKING AND INSPECTION NOTICE

Immediately upon receipt of the equipment, inspect the shipping container and the contents carefully for any discrepancies or damage. Should there be any, notify the freight company and OWI, Inc. or the dealer where purchased at once.

LIMITED WARRANTY

1. This product has been thoroughly tested and inspected at the factory. It is warranted for one year from the date of purchase.
IT IS THE OWNERS' RESPONSIBILITY TO ESTABLISH THE DATE OF PURCHASE BY ACCEPTABLE EVIDENCE AT TIME SERVICE IS SOUGHT.
2. Any unit, which in the judgment of OWI INC, is defective or develops defects under normal use will be replaced or repaired without cost within the warranty period.
3. This warranty will be considered void if the unit is dropped, misused, abused and altered in any manner, overdriven with excess amplification exceeding manufacturer's specification, improperly serviced or accidentally damaged.
4. OWI Inc. shall have no liability whatsoever for consequential damages. The sole responsibility at the discretion of OWI Inc. under this warranty shall be limited to the repair of the product or replacement thereof. Any and all implied warranties including the implied warranty of merchantability are limited to the duration of this express limited warranty.
OWI, Inc. is NOT liable for incidental or consequential damages of any kind.
5. IMPORTANT: This warranty is void unless the attached card is completed and mailed to OWI Inc. within 10 days following the date of purchase. Units must be sent to OWI Inc. or to the dealer where purchased.

RETURN SHIPPING INSTRUCTIONS, Obtain a RETURN AUTHORIZATION from:
OWI Inc., 17141 Kingsview Ave, Carson, CA 90746.
Phone (310) 515-1900, Fax (310) 515-1606

FCC Notice: This equipment has been tested and found to comply with the limits for a Class A digital device, pursuant to part 15 of the FCC Rules. These limits are designed to provide reasonable protection against harmful interference when the equipment is operated in a commercial environment. This equipment generates, uses, and can radiate radio frequency energy and, if not installed and used in accordance with the instruction manual, may cause harmful interference to radio communications. Operation of this equipment in a residential area is likely to cause harmful interference in which case the user will be required to correct the interference at his or own expense.

Modifications not expressly approved by the manufacturer could void the user's authority to be operated under FCC rules.

Table of Contents

Description	Page
Proprietary, Copyright Notices	2
Unpacking and Inspection	2
Warranty Information	2
Return Shipping Instructions	2
Table of Contents	3
Important Safety Instructions	4 - 5
Introduction	6
Specifications	7 - 8
Illustration: Connection and Control	9
Chained Self Amplified Speakers Wiring	10
Bluetooth Operation	11
One, Two, Four Speaker Combination Wiring	12
Input Connectors Wiring	13
Volume Control Wiring Diagram	14
Installation	15 - 18
Warranty	19
Back Cover	20

IMPORTANT SAFETY INSTRUCTIONS

CAUTION



RISK OF ELECTRIC SHOCK - DO NOT OPEN



NOTE: Installation is to be completed by a qualified electrical technician according to NEC/CEC code and applicable local codes.

CAUTION: The power supply is not to be used in air handling spaces.

CAUTION: To reduce the risk of electric shock: Do not remove the cover or back: No user-serviceable parts inside: refer servicing to qualified personnel.

The lightning flash with arrowhead within an equilateral triangle is intended to alert the user to the presence of uninsulated “dangerous voltage” within the product’s enclosure that may be of sufficient magnitude to constitute a risk of electric shock to persons.

The exclamation point within an equilateral triangle is intended to alert the user of the presence of important operating and maintenance (servicing) instructions in the literature accompanying the appliance.

The apparatus shall not be exposed to dripping or splashing and that no objects filled with liquids, such as vases, shall be placed on the apparatus.

IMPORTANT SAFETY INSTRUCTIONS

1. Read these instructions. All the safety and operation instructions should be read before this OWI product is operated.
2. Keep these instructions - The safety and operating instructions should be kept for future reference.
3. Heed all warnings - All warnings on this product and in these operating instructions should be followed.
4. Follow all instructions - All operating and other instructions should be followed.
5. Do not use this apparatus near water - for example, near a bathtub, washbowl, kitchen sink, laundry tub, in a wet basement, near a swimming pool, or a swamp.
6. Clean only with dry cloth.
7. Do not block any ventilation openings. Install in accordance with the manufacturer’s instructions. - This OWI product should be situated so that its location or position does not interfere with its proper ventilation. For example, the component should not be situated on a bed, sofa, rug, or similar surface that may block any ventilation openings, or placed in a built-in installation such as a bookcase or cabinet that may impede the flow of air through ventilation openings.
8. Do not install the unit near any heat sources such as radiators, heat registers, stoves or other apparatus (including amplifiers) that produce heat.

9. Do not defeat the safety purpose of the polarized or grounding-type plug. A polarized plug has two blades with one wider than the other. A grounding type plug has two blades and a third grounding prong. The wider blade or the third prong is provided for your safety. If the provided plug does not fit into your outlet, consult an electrician for replacement of the obsolete outlet.
10. Protect the power cord from being walked on or pinched particularly at plugs, convenience receptacles, and the point where they exit the apparatus.
11. Only use attachment/accessories specified by the manufacturers.



Portable Cart Warning

12. Use only with the cart, stand, tripod, bracket or table specified by the manufacturer, or sold with the apparatus. When a cart is used, use caution when moving the cart/apparatus combination to avoid injury from tip-over.
13. Unplug this apparatus during lightning storms or when unused for long periods of time.
14. Refer all servicing to qualified service personnel. Servicing is required when the apparatus has been damaged in any way, such as power-supply cord or plug is damaged, liquid has been spilled or objects have fallen into the apparatus, the apparatus has been exposed to rain or moisture, does not operate normally, or has been dropped. The user should not attempt to service this OWI product beyond those means described in this operating manual. All other servicing should be referred to the OWI Service Department.
15. **WARNING:** To reduce the risk of fire or electric shock, do not expose this apparatus to rain or moisture.
16. To prevent electric shock, do not use this polarized plug with an extension cord, receptacle or other outlet unless the blades can fully be inserted to prevent blade exposure.
17. Exposure to extremely high noise levels may cause permanent hearing loss. Individuals vary considerably in susceptibility to noise-induced hearing loss, but nearly everyone will lose some hearing if exposed to sufficiently intense noise for a period of time. The U.S. Government's Occupational Safety and Health Administration (OSHA) has specified the permissible noise level exposures shown in the following chart. According to OSHA, any exposure in excess of these permissible limits could result in some hearing loss. To ensure against potentially dangerous exposure to high sound pressure levels, it is recommended that all persons exposed to equipment capable of producing high sound pressure levels use hearing protectors while the equipment is in operation. Ear plugs or protectors in the ear canals or over the ears must be worn when operating the equipment in order to prevent a permanent hearing loss if exposure is in excess of the limits set forth here.
18. OWI recommends that this apparatus be placed on a switched power outlet, one that switches both sides and has contact separation of at least 3 millimeters.

End of IMPORTANT SAFETY INSTRUCTIONS

Introduction

The OWI **AMP-BT2SIC5 / AMP-BT2SIC6** is a self powered speaker/amplifier. This unit can drive up to four speakers connected series parallel to have a net impedance of 8 ohms. With an included UL Listed, **Level 5** (Energy Star), 15 volt, 3.5 ampere power supply, the amplifier can output 40 watts, or 10 watts per speaker in a four speaker hook-up.

Special features of the OWI Model AMP-BT2SIC5 / AMP-BT2SIC6 include:

Bluetooth Feature

Certified SIG Bluetooth Version 3.0, Frequency Range 2.40 – 2.48 MHz, Supports A2DP, AVRCP, HFP/HSP and SPP, Password Protected.

Energy Star Mode

If no audio is present on any input, the power consumption of the speaker amplifier is less than one (1) watt.

Two (2) audio inputs: Line In and Jack Line In

The **LINE IN** inputs accepts a balanced input via a Phoenix style screw terminal plug. The **JACK LINE IN** accepts unbalanced input via 3.5 mini jack. The mini jack accept stereo inputs. The stereo channels are summed together. This input is muted during Priority Override.

Priority Override Feature

The **Priority** input accepts balanced input levels of resistor selected 100 volts audio, 70 volts audio, 25 volts audio and 1 volt (approximately line level) audio. Audio on the **Priority** input suspends audio on the **Line In and Jack Line In** inputs and switches the speaker amplifier to pass the **Priority** audio. After the **Priority** audio stops, the unit waits before returning to the **Line In and Jack Line In** audio input.

Balanced Line Level Output

A nominal 0dB level, balanced output is available at LINE OUT. The source of this output is both balanced and Jack Line In sources.

Power Amplifier Features

The power amplifier outputs 2 times 20 watts or 40 watts total into 8 ohms and 15VDC power. The class D power amplifier has reduced radiated electromagnetic interference (EMI) due to a special feature of the power amplifier, operating in a patented spread spectrum. The power amplifier protects itself from over-temperature, over-current, over-voltage conditions. The power amplifier will shut itself down during these conditions.

IMPORTANT NOTE! This amplifier is intended for audio use only! Continuous sine wave drive into a load will cause the amplifier to shut itself down when it heats up.

OWI User Manual: Model AMP-BT2SIC5 / AMP-BT2SIC6 Speaker Amplifier
 Model AMP-BT2SIC5 / AMP-BT2SIC6 Speaker Amplifier

SPECIFICATIONS (MODEL AMP-BT2SIC5 / AMP-BT2SIC6)

BLUETOOTH SPECIFICATIONS
AMP-BT2SIC5 / AMP-BT2SIC6
Certified SIG Bluetooth Version 3.0
Frequency Range 2.40 – 2.48 MHz
Supports A2DP, AVRCP, HFP/HSP and SPP
Password Protected

ELECTRICAL AMPLIFIER	SPECIFICATIONS	
	AMP-BT2SIC5	AMP-BT2SIC6
Input voltage, nominal	(25 watts) 15 volts DC	(25 watts) 15 volts DC
Input current, operating (15VDC)	1.667 amperes peak	1.667 amperes peak
Input volt-amperes, peak (15VDC)	25 volt-amperes	25 volt-amperes
Input voltage, maximum	16.5 volts, DC	16.5 volts, DC
Frequency Response,		
EQ set to flat	50Hz to 15 kHz	50Hz to 15 kHz
Bass	±10dB@50Hz	±10dB@50Hz
Treble	±10dB@10kHz	±10dB@10kHz
THD + Noise	<1% at 15 watts, "A" weighted	<1% at 15 watts, "A" weighted
S/N	>90 dB	>90 dB
Max Power Output (28V in)	2 times 20 watts or a total of 40 watts	2 times 20 watts or a total of 40 watts
DC Power, Standby	1.5 watts	1.5 watts
AC Power, Sleep Mode (Energy Star)	less than 1 watt	less than 1 watt
DC Power,		
Short Circuit protected	Yes	Yes
Over current protected	Yes	Yes
Over voltage protected	Yes	Yes
Over temperature protected	Yes	Yes
Minimum Load Impedance	4.0 Ω (Two 8 Ω Speakers in parallel)	4.0 Ω (Two 8 Ω Speakers in parallel)
Minimum Input impedance, Priority in	20,000 Ω	20,000 Ω
Minimum Input impedance, Bal. Line in	820 Ω	820 Ω
Minimum Input impedance, mini-jack	2300 Ω	2300 Ω
Dynamic Mic input impedance	300 Ω	300 Ω
Warranty	1 year	1 year

OWI User Manual: Model AMP-BT2SIC5 / AMP-BT2SIC6 Speaker Amplifier
Model AMP-BT2SIC5 / AMP-BT2SIC6 Speaker Amplifier

Mechanical "UL rating is dependent upon use of the Backcan and Tile Bridge"

	SPECIFICATIONS	
	AMP-BT2SIC5	AMP-BT2SIC6
Speaker Diameter	5.25 inches	6.5 inches
Weight of Amplifier/Speaker Assembly	2.55 pounds	3.15 pounds
Height of Amplifier/Speaker Assembly	4 inches	4.5 inches
Backcan "Suitable for use in air handling spaces"	UL Listed Enclosure	UL Listed Enclosure
Tile Bridge "Suitable for use in air handling spaces"	UL Listed Support Truss	UL Listed Support Truss

POWER SUPPLY

PS15VDC35AL5	SPECIFICATIONS
Input	100 to 240 VAC, 50-60 Hz, 1.4A Note: Be sure to use the correct polarity on the power input.
Output	15 VDC, 3.5 amperes
Wire gauge and length	Minimum 18 gauge up to 40 feet maximum length
Electrical, Power Supply	UL Listed, Level 5 (Energy Star)
Weight	0.45 pounds
Size	4.7"H x 2"W x 1.2"D

CAUTION: The Power Supply is not to be used in air handling spaces.

**Note: Maximum power requires the replacement of the 15 volt supply with a 22 volt supply and Energy Star and UL approvals no longer apply.*

Power Supply Wire Gauge and Length - Minimum 18 gauge up to 40 feet maximum length

NON-AMPLIFIED SPEAKER	SPECIFICATIONS	
	IC5	IC6
DESCRIPTION:	5.25", 2-way, coaxial	6.5", 2-way, coaxial
IMPEDANCE:	8 ohms	8 ohms
SENSITIVITY (1W/1M):	85dB	86dB
DISPERSION:	120 degrees	120 degrees
MAX POWER (8 Ohms)	40 watts	50 watts
NOMINAL POWER (8 Ohms)	20 watts	25 watts
FREQUENCY RESPONSE:	80Hz ~ 20 kHz	65Hz ~ 20 kHz
WOOFER SIZE:	5.25"	6.5"
WOOFER MATERIAL:	Paper, PP coated	Paper, PP coated
TWEETER SIZE:	0.5"	0.5"
TWEETER MATERIAL:	PEI	PEI
GRILL MATERIAL:	Aluminum	Aluminum
OVERALL DIMENSIONS (Diameter X Height): Inches	Φ7.95*3.15	Φ8.93*3.45
CUT OUT SIZE (Diameter): Inches	Φ6.61	Φ7.68
WEIGHT: lbs.	2.26	2.5
MOUNTING HARDWARE:	Mounting Clamps	Mounting Clamps

End of Specifications

Illustration: Connection and Control

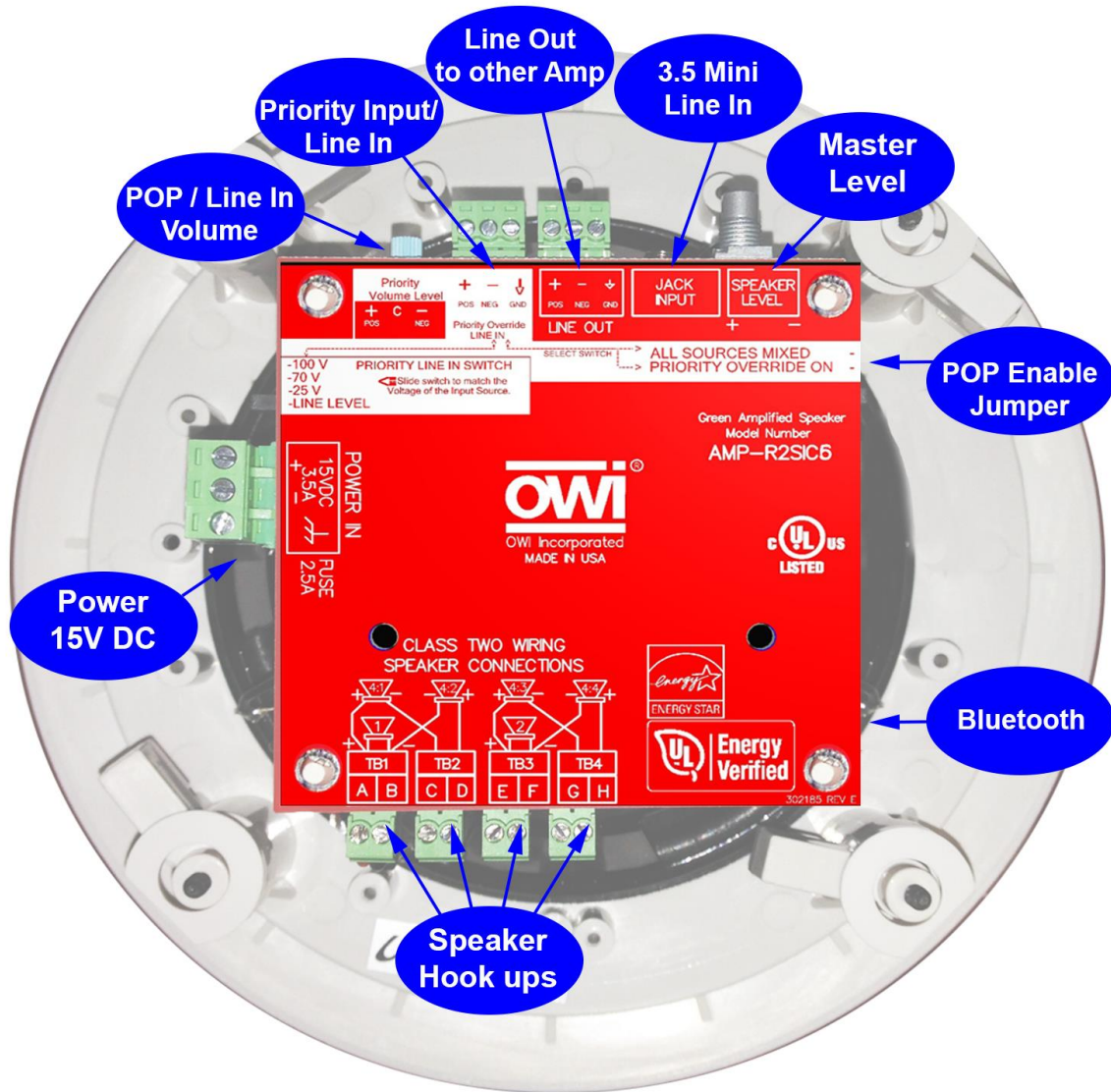

AMP-BT2SIC5 / AMP-BT2SIC6 TO ANOTHER AMP-BT2SIC5 / AMP-BT2SIC6 SPEAKER WIRING SINGLE LINE DIAGRAM

Chained Self Amplified Speakers Wiring

To add more Amplified Speakers, connect the output of the Amplified Speakers to the input of the next Amplified Speaker

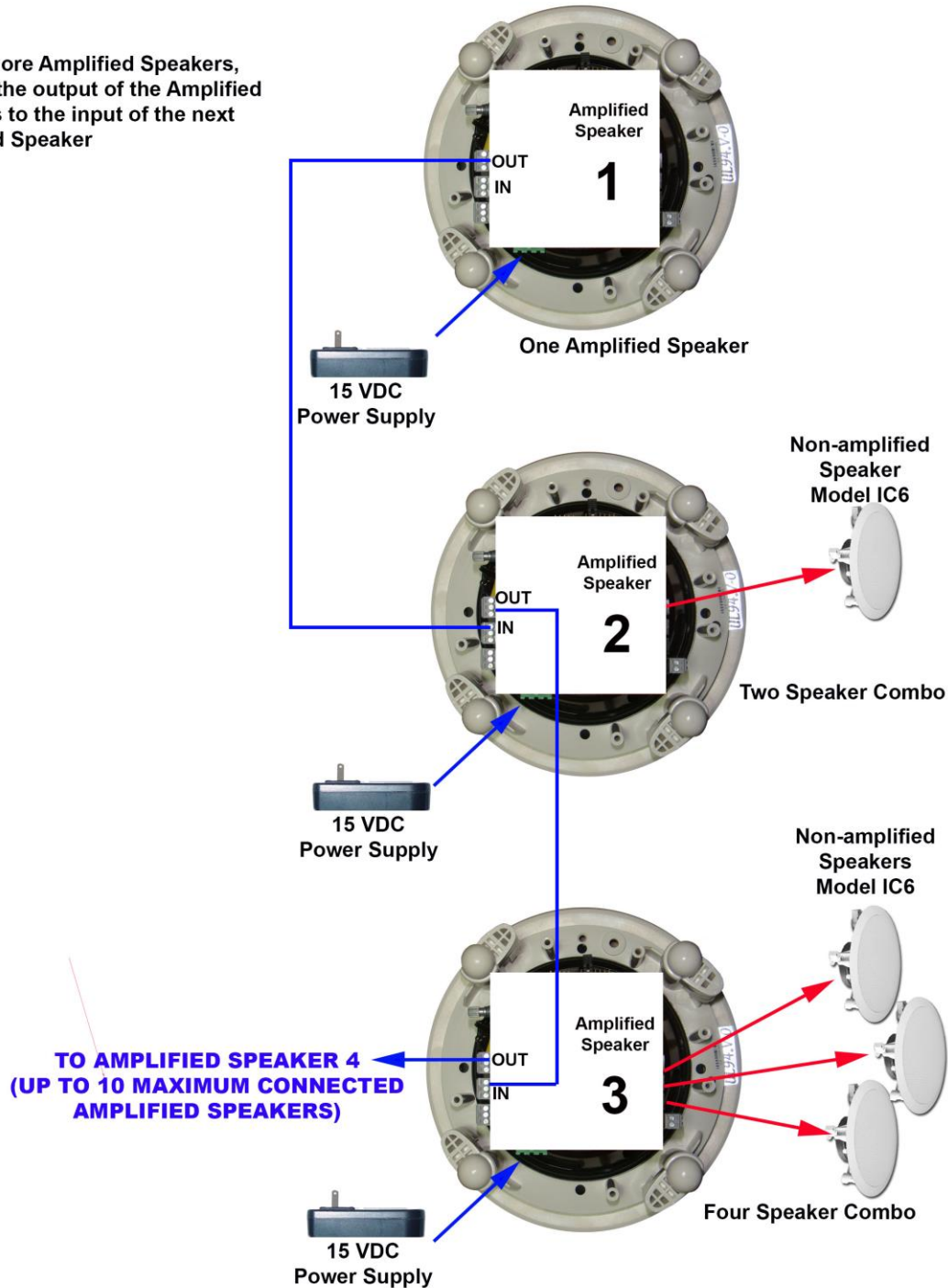

BLUETOOTH OPERATION

Discovery

- When the speaker amp is first turned ON, the Red LED light will turn ON and the speaker amp should be discoverable by a Bluetooth enabled device such as a PC, tablet, iPhone or other smartphone.
- Open the device Bluetooth manager and review its list of discoverable Bluetooth devices. The speaker amp will appear as OWI-XXXX where XXXX is the last 4 digits of the speaker amp MAC address. Note: The speaker amp MAC address is identified on a label located on the speaker amp board.

Pairing

- Select the OWI-XXXX Bluetooth device from the list and the device will pair with the speaker amp. Note: If the speaker amp is password protected, you will be required to enter the correct PIN before the pairing process will begin. If the PIN has not been changed on the speaker amp, entering 1234 will begin the pairing process.

Operation

Once the speaker amp is paired with the device, audio from the device should pass through and be heard from the speaker(s) connected to the speaker amp.

Reset Bluetooth settings

It is possible to reset all Bluetooth settings including the Bluetooth PIN to the factory default values.

- Turn the power OFF to the speaker amp.
- Locate the 5pin header on the speaker amp board.
- Plug in the reset receptacle onto the header.
- Turn the power ON to the speaker amp.
- Wait 10secs
- View the newly generated PIN listed on your device 'PIN XXXX' where XXXX is the new PIN. Note: every time the reset receptacle is installed onto the 5pin header, a new PIN will be generated.
- Write down the PIN and keep in a safe place.
- Turn the power OFF to the speaker amp.
- Remove the reset receptacle from the 5pin header.
- All Bluetooth settings including the PIN have been reset to the factory settings.

OWI User Manual: Model AMP-BT2SIC5 / AMP-BT2SIC6 Speaker Amplifier
 Model AMP-BT2SIC5 / AMP-BT2SIC6 Speaker Amplifier
One, Two, Four Speaker Combination Wiring

AMPLIFIED SPEAKER TO NON-AMPLIFIED SPEAKER HOOK UPS

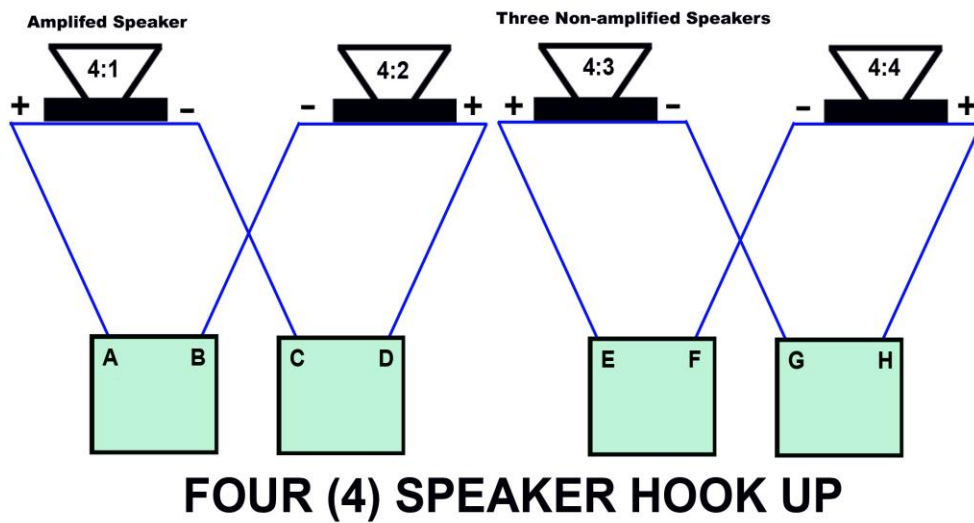
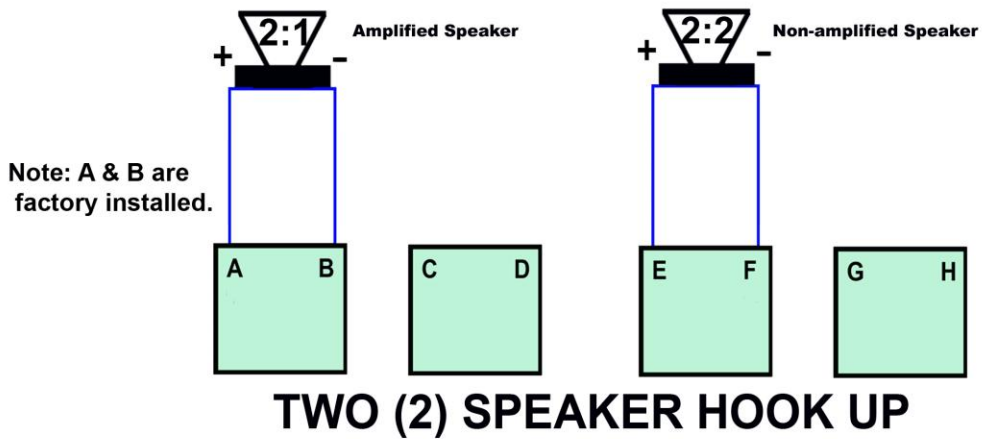
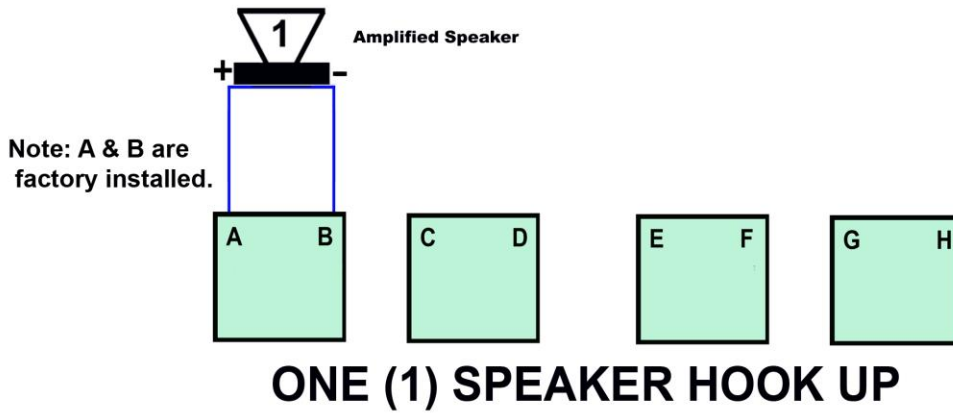

INPUT CONNECTORS WIRING

Note: Jack Line In is the same as STEREO LINE IN, immediately below.

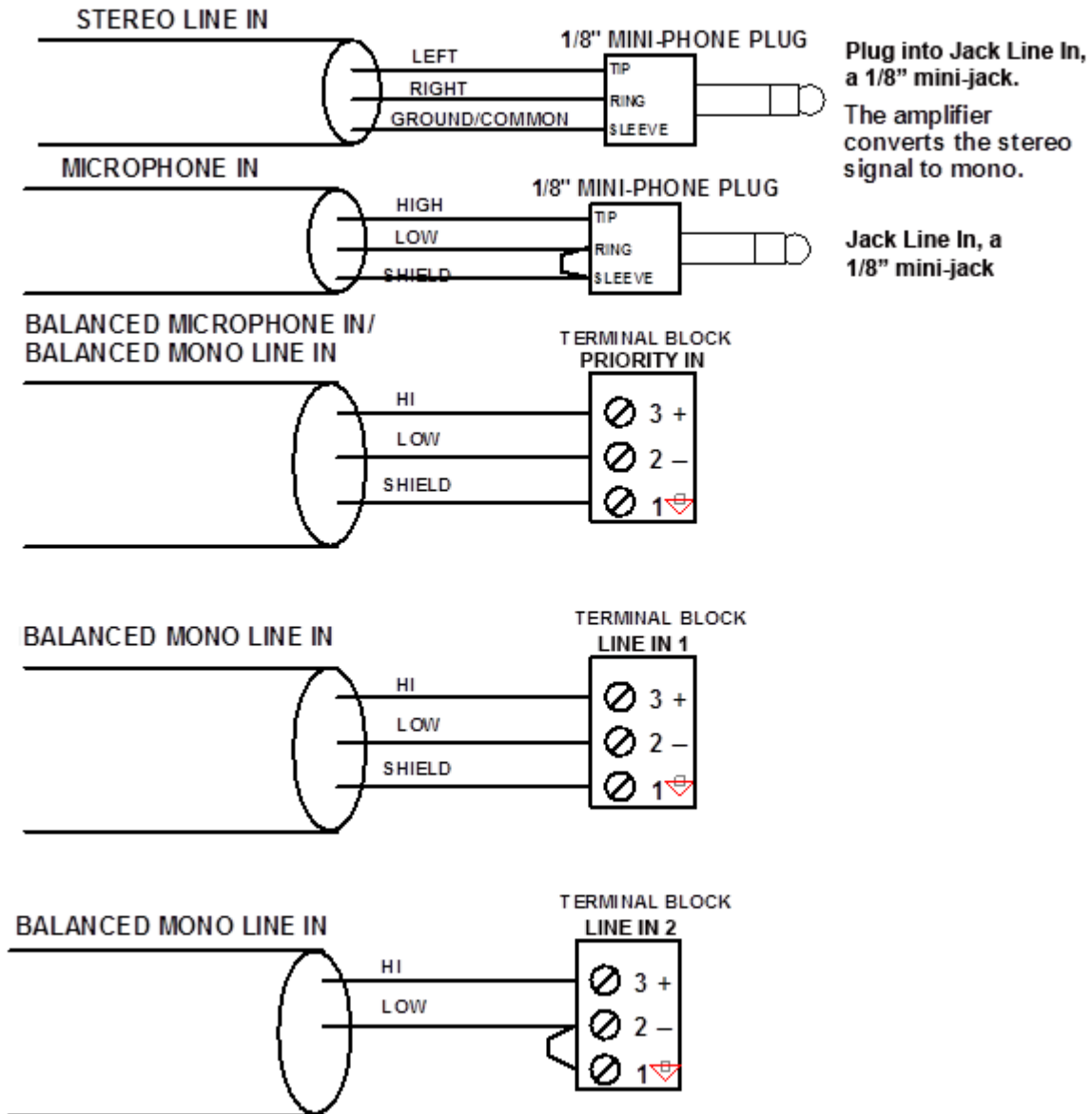

VOLUME CONTROL WIRING DIAGRAM



MODEL AMPSTVCW
Stereo/Mono Mixer Volume Control

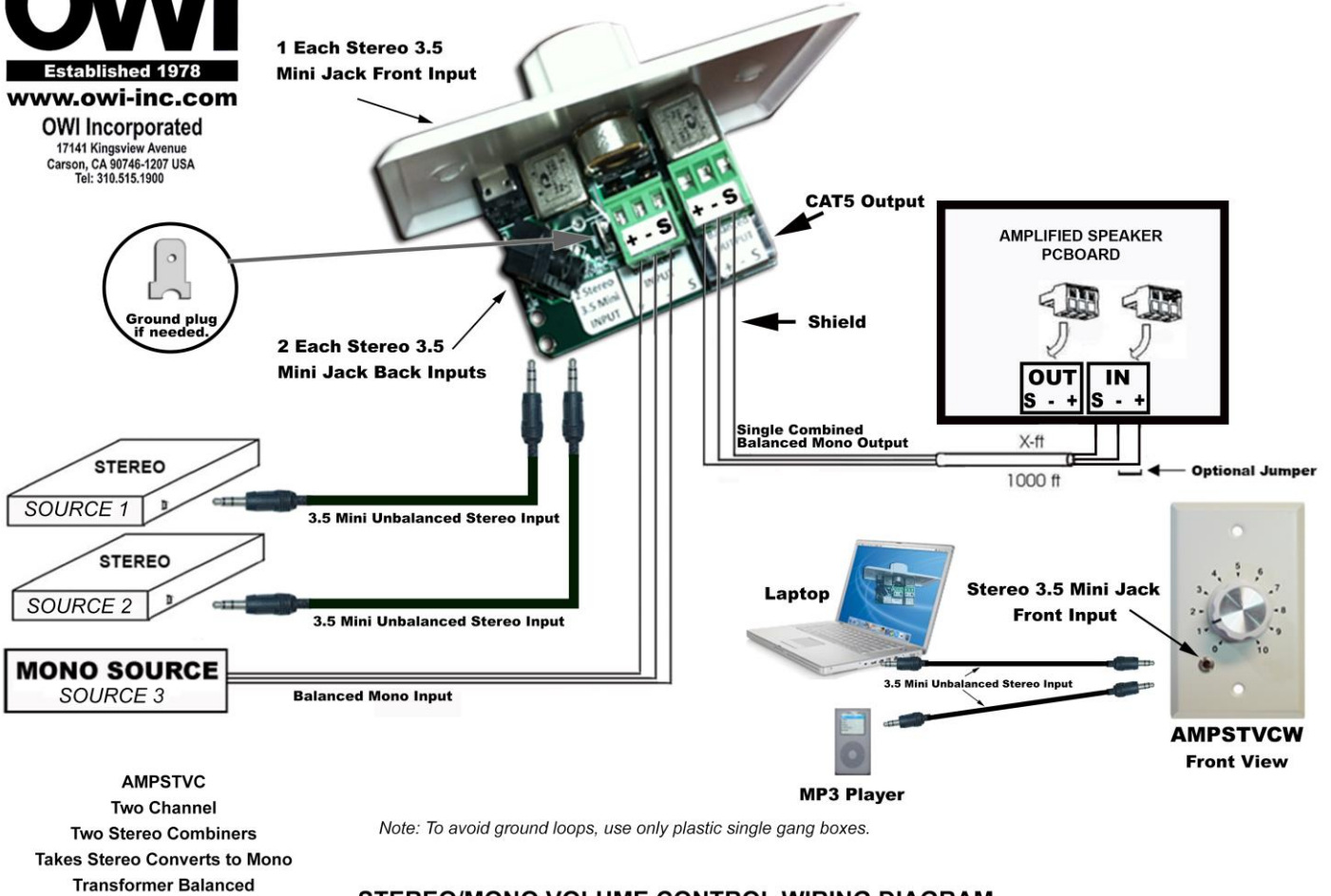

STEREO/MONO VOLUME CONTROL WIRING DIAGRAM

09/17/15

INSTALLATION

NOTE: Installation is to be completed by a qualified electrical technician according to NEC/CEC code and applicable local codes.

Installation Instructions for Speaker Combination Model AMP-BT2SIC5 / AMP-BT2SIC6

The AMP-BT2SIC5 / AMP-BT2SIC6 carton includes:

1. One (1) each AMP-BT2SIC5 / AMP-BT2SIC6 (In-ceiling 2 Source Amplified Speaker)
2. One (1) each UL Listed, Level 5 (Energy Star) Power Supply (*electrical wire not included*)
3. Four (4) each Mounting screws
4. One (1) each cardboard mounting template
5. One (1) each User Manual

The AMP-BT2SIC5 / AMP-BT2SIC6 Combination carton includes items 1 to 5 above plus the following:

1. UL Listed 8 ohms in-ceiling speaker model IC5 / IC6
 2. UL Listed Backcan Enclosure (See Pages 15 & 16)
 3. UL Listed Tile Bridge (See Pages 15 & 16)
- *Note: Quantity of Ceiling speakers, tile bridge and backcan depends on the SKU of the AMP-BT2SIC5 / AMP-BT2SIC6 Combination Program.*

Speaker Placement

Before installing your OWI speakers, consider the placement carefully, taking into effect the location of electrical, plumbing and other fixtures.

Placement in Ceiling

OWI speakers should be located above the primary listening area.

Mounting your OWI speakers

Determine the best area to mount your OWI speakers. It will be necessary to run your speaker wires to that location. This location must be free of obstructions, such as electrical conduits, HVAC ducts, or water lines.

Be sure the mounting surface is between 3/8 and 1 ¼ inches thick and that there is at least a 3 inch clearance behind the mounting surface (5 inch if using an OWI backcan). Make sure that no objects block the back of the speaker.

Remove the round cardboard disc from the template supplied and keep it for later use as a paint mask, if you decide to paint your speakers.

Use the template to mark the position for the mounting hole at the selected location. If you are not certain that no obstruction exists (electrical wiring, plumbing, etc.), you should start by cutting a small hole in the center of your penciled mounting hole with a drywall or keyhole saw, cutting at a 45 degree angle towards the inside of the hole. Cutting a small hole at this angle will make drywall repair much easier. Once you have determined there are no obstructions in your desired mounting location, start cutting the finished hole at a 90 degree angle to the ceiling surface.

Route the speaker wires from your amplifier to your opening. Avoid routing the speaker wire near electrical wires. If you have to run them parallel, make certain to space the speaker wires at least 2 feet from the AC line. Do not nail or staple the speaker wire.

Prepare Your OWI Speakers for Mounting

Insert a paper clip into one of the grille openings, then pull upwards to remove the grille.

Turn the mounting tab 90° and push toward the grill. The grill will safely pop off.

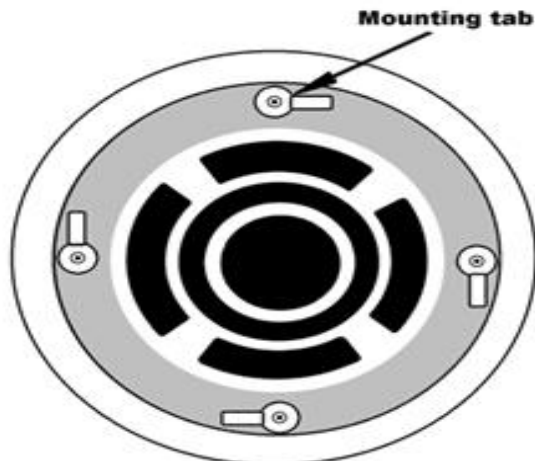
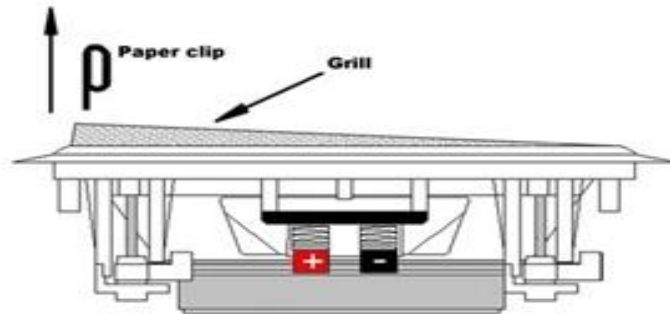

Be sure to position the four Mounting Tabs on your OWI speaker inward then insert the four (4) screws (supplied) from the front of the speaker into the screw opening.

DRYWALL/STUCKO/SHEET ROCKS CEILING ASSEMBLY

The Quick and Easy Way to Install the OWI TB (Tile Bridge) and the Backcan Enclosure with a 6-1/2" or 5-1/4" OWI In-Ceiling Speaker.

1. Position the enclosure over the speaker hole and align it with the screw holes in the tile bridge. Insert and tighten 4 screws through the enclosure into the holes on top of the tile bridge.

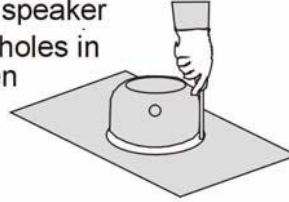

2. Insert and tighten four screws to attach the tile bridge to the beam.

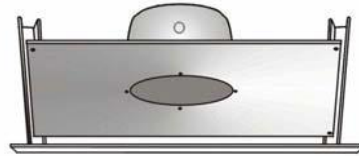

3. After hole is cut in the ceiling, connect the wires and install the speaker by tightening the screws of the four clamps.

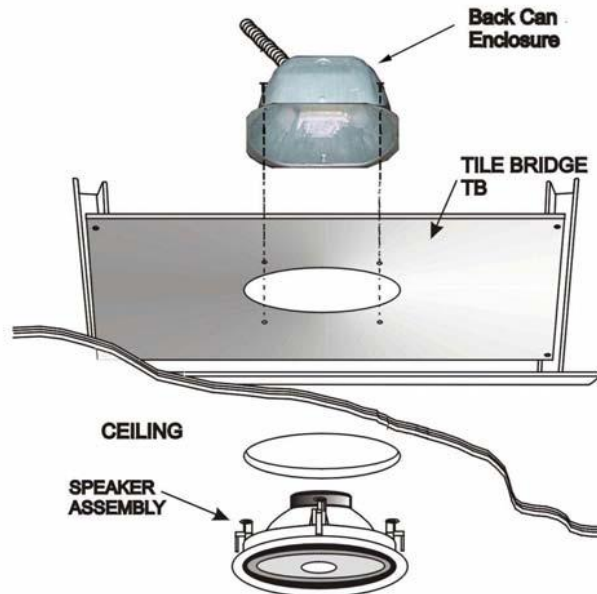
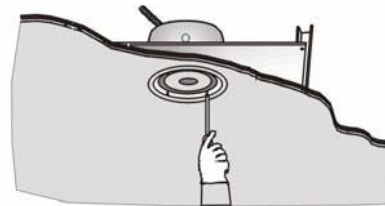

OWI INCORPORATED
17141 Kingsview Avenue, Carson, CA 90746-1207 USA
Tel: 310.515.1900 Fax: 310.515.1606
Email: info@owi-inc.com Website: www.owi-inc.com





OWI INCORPORATED
 17141 Kingsview Avenue, Carson, CA 90746-1207 USA
 Tel: 310.515.1900 Fax: 310.515.1606
 Email: info@owi-inc.com Website: www.owi-inc.com



The Quick and Easy Way to Install the OWI TB (Tile Bridge) and the Backcan Enclosure with a 6-1/2" or 5-1/4" OWI In-Ceiling Speaker.

The TB will work on a 2' X 4', 2' X 2' lay-in type ceilings.

<p>1. Use one tile bridge (TB) as a template to make cut outs for all the ceiling tiles.</p>		<p>5. Remove the template and saw out the circle (speaker hole). Set ceiling tiles aside.</p>	
<p>2. To save time, cut 2 ceiling tiles at the same time. Lay the ceiling tile face to face.</p>		<p>6. Place one ceiling tile face down on the floor or on top of a table. Position the TB tile bridge across the tile with the speaker holes coinciding with each other.</p>	
<p>3. After finding the center of the ceiling tile, position the tile bridge template across the tile.</p>		<p>7. Position the enclosure over the speaker hole and align it with the screw holes in the tile bridge. Insert and tighten 4 screws through the enclosure into the holes on top of the tile bridge through the ceiling tile.</p>	
<p>4. Draw a circle using the speaker hole of the template (tile bridge).</p>		<p>8. After connecting the speaker wire, insert the speaker assembly through the hole and tighten the screws of the 4 clamps. The 4 clamps will hold the TB and the ceiling tile together.</p>	

TEE BAR CEILING ASSEMBLY

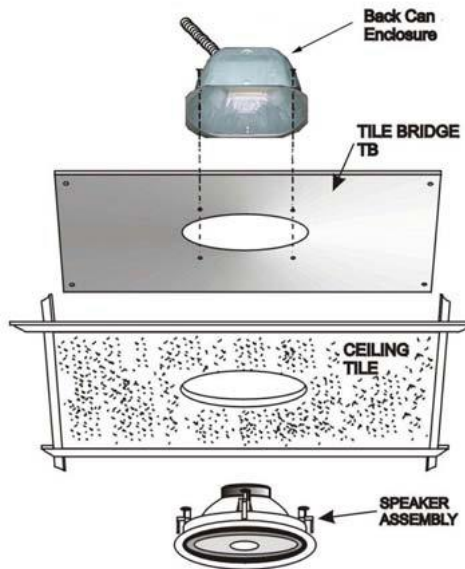

OWI SPEAKER SYSTEM LIMITED WARRANTY REGISTRATION

(Save this portion for your records)

1. Your OWI Speaker System has been thoroughly tested and inspected at the factory. It is warranted for 1 year from date of purchase.
IT IS THE OWNERS' RESPONSIBILITY TO ESTABLISH THE DATE OF PURCHASE BY ACCEPTABLE EVIDENCE AT TIME SERVICE IS SOUGHT.
2. WHAT WE WILL PAY FOR AND WHAT YOU MUST PAY FOR:
OWI INC. will repair or replace unit(s) covered by this warranty, without charge to the consumer for labor or materials. YOU ARE RESPONSIBLE FOR ANY INSTALLATION OR REMOVAL CHARGES AND FOR ANY INITIAL SHIPPING CHARGES if the unit(s) must be shipped for warranty service. However, we will pay the return shipping charges to any destination within the U.S.A. if the repairs are covered by the warranty.
3. Any unit which in the judgment of OWI Inc. is defective or develops defects under normal use will be replaced or repaired without cost within the warranty period.
4. This warranty will be considered void if unit has been dropped, misused, abused, altered in any manner, overdriven with excessive amplification exceeding manufacturer's specification, improperly serviced or accidental damage.
5. OWI Inc. shall have no liability whatsoever for consequential damage. The sole responsibility and discretion of OWI Inc. under this warranty shall be limited to the repair of the product or replacement thereof.
6. IMPORTANT: This warranty is void unless the attached card is completed and mailed to OWI Inc. within 10 days following the date of purchase. Units must be sent to OWI Inc. or to the dealer where purchased.

OWI INCORPORATED
17141 Kingsview Ave
Carson, CA 90746-1207 USA

Date Purchased: _____
Model Number: _____
Serial Number: _____

(Keep this part for your record)

-----CUT AND MAIL-----



OWI INCORPORATED
17141 Kingsview Ave
Carson, CA 90746-1207 USA

LIMITED WARRANTY

Model Number: _____
 Model Name: _____
 Serial No. _____
 Date of Purchase: Month: _____ Day _____ Year _____
 Owner's Name: _____
 Address: _____
 City: _____ State _____ Zip _____
 Dealer's Name: _____ City _____ State _____
 Purchased from (please check one):
 Video _____, Electronic _____, Mailorder _____, Mass Merchandiser _____, Installer _____
 Others (please specify) _____
 Remarks: _____

OWI User Manual: Model AMP-BT2SIC5 / AMP-BT2SIC6 Speaker Amplifier
Model AMP-BT2SIC5 / AMP-BT2SIC6 Speaker Amplifier



OWI Incorporated
Established 1978

OWI Incorporated

17141 Kingsview Ave. Carson CA 90746-1207 USA
Tel. 310-515-1900 Fax 310-515-1606

www.owi-inc.com