

2MP HDCVI Fixed Bullet Camera

Starlight+ Technology and True Wide Dynamic Range

HDCVI



- 1/2.8-in. 2 MP Progressive-scan CMOS Sensor
- 2 MP (1920 x 1080) at 30 fps Maximum Resolution
- 3.6 mm Fixed Lens
- Starlight+ Technology for Low-light Applications
- True Wide Dynamic Range (120 dB) and 3D Noise Reduction
- ArcticPro Series Camera — Operational down to -40°C (-40°F)
- Supports Multiple Video Formats: HDCVI, CVBS, AHD and TVI
- HD or SD Output, Switchable
- Built-in Microphone
- Maximum IR Length 80 m (262.47 ft)
- IP67 Ingress Protection
- Five-year Warranty*



System Overview

Experience the superior clarity of Dahua's 2 MP HDCVI camera for vast coverage and superior image details. The 2 MP HDCVI series leverages existing coax infrastructures to deliver forensic-level images seamlessly and over long distances. The camera offers a 3.6 mm fixed lens, a multi-language On-screen Display, and HD/SD switchable output. The camera is ideal for hosting diverse applications — Starlight Technology and True Wide Dynamic Range allow the camera to operate in any lighting condition and the IP67 rating makes the camera suitable for the harshest environments.

Functions

Starlight+ Technology

For challenging low-light applications, Dahua's Starlight low light Technology offers best-in-class light sensitivity, capturing details in low light applications. The camera uses a set of optical features to balance light throughout the scene, resulting in clear images in dark environments.

Three Signals over One Coaxial Cable

HDCVI technology simultaneously transmits video, audio, and data over a single coaxial cable. Dual-way data transmission allows the HDCVI camera to communicate with an HCVR to send control signals or to trigger alarms.

Long Distance Transmission

HDCVI technology guarantees real-time transmission over long distances without loss of video quality. HDCVI cameras provide the same resolution as most IP network camera systems using existing RG-59, RG-6, or CAT 6 UTP cabling.

Simplicity

HDCVI technology seamlessly integrates traditional analog surveillance systems with upgraded, high-quality HD video, making it the best choice to protect security investments. The plug and play approach enables full HD video surveillance without the hassles of configuring a network.

Super Adapt

The Super Adapt function is a built-in algorithm that automatically adjusts the camera's optical settings as environmental conditions change to produce optimal video quality. This function helps to make initial configuration easy since it does not require setting the optical settings manually once the camera is installed.

Broadcast-quality Audio

Audio information is used as supplementary evidence in video surveillance applications. This HDCVI camera transmits audio signals over the coaxial cable, eliminating the need for separate audio wiring. In addition, the camera uses unique audio processing and transmission technology that eliminates noise to best duplicate source audio, guaranteeing high-quality and highly effective audio information.

Multiple-format Support

The camera supports multiple video formats including, HDCVI, CVBS, AHD, and TVI. The camera can switch between these four formats via the switch located on the video output cable, making the camera compatible with not only HDCVI DVRs but also most existing HD/SD DVRs.

True Wide Dynamic Range

The camera achieves vivid images, even in the most intense contrast lighting conditions, using industry-leading wide dynamic range (WDR) technology. For applications with both bright and low lighting conditions that change quickly, True WDR optimizes both the bright and dark areas of a scene at the same time to provide usable video.

Protection

The camera is subjected to rigorous dust and water immersion tests and certified to the IP67 Ingress Protection rating making it suitable for demanding outdoor applications. The camera allows for $\pm 30\%$ input voltage tolerance, suitable for the most unstable conditions for outdoor applications, and its 4KV lightning rating provides effective protection for both the camera and its structure against lightning.

Technical Specification

Camera

Image Sensor	1/2.8-in. CMOS Sensor
Effective Pixels	1920 (H) x 1080 (V), 2 MP
Scanning System	Progressive
Electronic Shutter Speed	1/30 s to 1/100,000 s
Minimum Illumination	Color: 0.001 lux at F1.6, 30 IRE 0 lux at F1.6 with IR On
S/N Ratio	More than 65 dB
IR Distance	Up to 80.0 m (262.47 ft)
IR Control	Auto, Manual
IR LEDs	Four (4)

Lens

Lens Type	Fixed Lens
Mount Type	M12
Focal Length	3.6 mm
Maximum Aperture	F1.6
Angle of View	Horizontal: 86° Vertical: 46° Diagonal: 101°
Iris Type	Fixed Iris
Close Focus Distance	1100.0 mm (43.31 in.)

Installation Angle

Range	Pan: 0° to 360° Tilt: 0° to 90° Rotation: 0° to 360°
-------	--

DORI Distances¹

Detect (8 ppf)	Observe (19 ppf)	Recognize (38 ppf)	Identify (76 ppf)
53.70 m (176.18 ft)	21.50 m (70.54 ft)	10.70 m (35.10 ft)	5.40 m (17.72 ft)

Video

Maximum Resolution	1080p (1920 x 1080), 960H (960 x 480)	
Frame Rate	HDCVI	1080p at 30 fps
	AHD	1080p at 30 fps
	TVI	1080p at 30 fps
	CVBS	960 x 480H at 30 fps
Video Output	One (1) BNC, Transmits HDCVI High-definition signal or CVBS, AHD or TVI Channel, switchable	
Video Transmission ²	RG-59/U Coax	720p: 800 m (2624.67 ft) 1080p: 500 m (1640.42 ft)
	RG-6/U Coax	720p: 1200 m (3937.01 ft) 1080p: 800 m (2624.67 ft)
	CAT 6 UTP (balun required)	720p: 450 m (1476.38 ft) 1080p: 300 m (984.25 ft)
Day/Night	Auto (ICR), Manual	
OSD Menu	Multi-language	
BLC Mode	BLC, HLC, True WDR	
WDR	120 dB	
Gain Control	Auto, Manual	
Noise Reduction	3D	
White Balance	Auto, Manual	
Mirror	On, Off	
Smart IR	Auto, Manual	
Privacy Masking	Off/On (8 areas, rectangular)	

Certifications

CE	EN55032 EN55024 EN50130-4
Safety	UL60950-1 CAN/CSA C22.2 No.60950-1
Electromagnetic Compatibility (EMC)	CFR 47 FCC Part 15 subpart B ANSI C63.4-2014

Interface

Video	One (1) Port, BNC HDCVI, TVI, AHD, CVBS selectable via DIP Switch
Audio	One (1) Built-in Microphone

Electrical

Power Supply	12 VDC ± 30%
Power Consumption	Maximum 7.7 W (12 VDC, IR On)

Environmental

Operating Conditions	-40° C to +60° C (-40° F to +140° F) Less than 95% RH
Storage Conditions	-40° C to +60° C (-40° F to +140° F) Less than 90% RH
Ingress Protection	IP67

1. The DORI distance is a measure of the general proximity for a specific classification to help pinpoint the right camera for your needs. The DORI distance is calculated based on sensor specifications and lab test results according to EN 62676-4, the standard that defines the criteria for the Detect, Observe, Recognize and Identify classifications.
2. Transmission distance results verified by real-scene testing in Dahua's test laboratory. Actual transmission distances may vary due to external influences, cable quality, and wiring structures.

Construction

Casing	Metal
Dimensions	244.10 mm x 90.70 mm x 90.40 mm (9.61 in. x 3.57 in. x 3.56 in.)
Net Weight	0.77 kg (1.70 lb)
Gross Weight	1.04 kg (2.29 lb)

Ordering Information

Type	Part Number	Description
2 MP Camera	A22DF63	2 MP Starlight+ 3.6 mm Fixed Lens Bullet Camera, True WDR
Accessories, optional	PFA130-E	Waterproof Junction Box (use alone, with PFA152-E pole mount or with PFA151 corner mount)
	PFA151	Corner Mount Bracket (use with PFA130-E junction box)
	PFA152-E	Pole Mount (use with PFA130-E junction box)
	PFM800-E	Passive HDCVI Balun
	DH-PFM321D-US	12 VDC, 1 A Power Adapter

Accessories

Optional:



PFA130-E
Junction Box



PFA151
Corner Mount



PFA152-E
Pole Mount



DH-PFM321D-US
12 VDC, 1 A
Power Adapter



PFM800-E
Passive HDCVI Balun

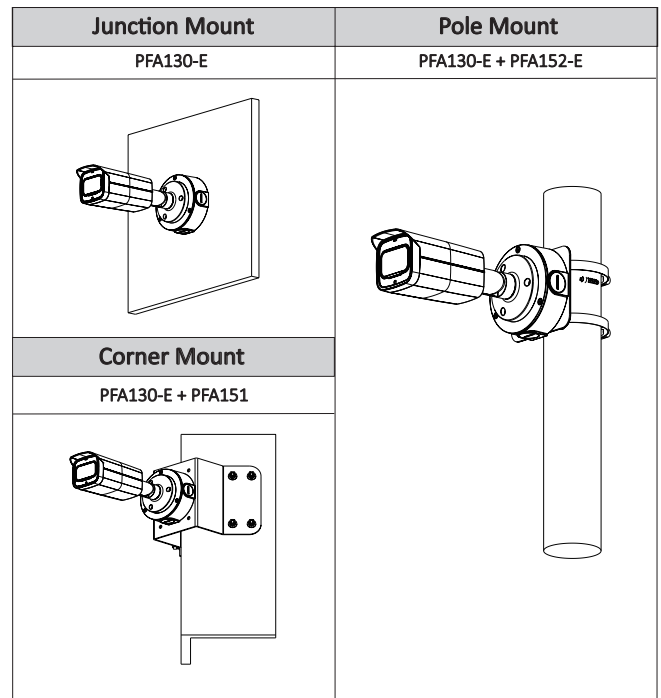

Dimensions (mm/in.)

