

SAMSUNG

FULL MANUAL

HW-LST70T

Imagine the possibilities

Thank you for purchasing this Samsung product.

To receive more complete service, please register
your product at www.samsung.com/register

SAFETY INFORMATION









SAFETY WARNINGS

TO REDUCE THE RISK OF ELECTRIC SHOCK, DO NOT REMOVE THE COVER (OR BACK).

NO USER-SERVICEABLE PARTS ARE INSIDE.

REFER SERVICING TO QUALIFIED SERVICE PERSONNEL.

Refer to the table below for an explanation of symbols which may be on your Samsung product.

	<p style="text-align: center;">CAUTION RISK OF ELECTRIC SHOCK. DO NOT OPEN.</p>	
	<p>This symbol indicates that high voltage is present inside. It is dangerous to make any kind of contact with any internal part of this product.</p>	
	<p>This symbol indicates that this product has included important literature concerning operation and maintenance.</p>	
	<p>Class II product : This symbol indicates that it does not require a safety connection to electrical earth (ground). If this symbol is not present on a product with a power cord, the product MUST have a reliable connection to protective earth (ground).</p>	
	<p>AC voltage : This symbol indicates that the rated voltage marked with the symbol is AC voltage.</p>	
	<p>DC voltage : This symbol indicates that the rated voltage marked with the symbol is DC voltage.</p>	
	<p>Caution, Consult instructions for use : This symbol instructs the user to consult the user manual for further safety related information.</p>	

WARNING

- To reduce the risk of fire or electric shock, do not expose this appliance to rain or moisture.

CAUTION

- TO PREVENT ELECTRIC SHOCK, MATCH WIDE BLADE OF PLUG TO WIDE SLOT, FULLY INSERT.
- This apparatus shall always be connected to a AC outlet with a protective grounding connection.
- To disconnect the apparatus from the mains, the plug must be pulled out from the mains socket, therefore the mains plug shall be readily operable.
- Do not expose this apparatus to dripping or splashing. Do not put objects filled with liquids, such as vases on the apparatus.
- To turn this apparatus off completely, you must pull the power plug out of the wall socket. Consequently, the power plug must be easily and readily accessible at all times.

Wiring the Main Power Supply Plug (UK Only)

IMPORTANT NOTICE

The mains lead on this equipment is supplied with a moulded plug incorporating a fuse. The value of the fuse is indicated on the pin face of the plug and if it requires replacing, a fuse approved to BS1362 of the same rating must be used. Never use the plug with the fuse cover removed. If the cover is detachable and a replacement is required, it must be of the same colour as the fuse fitted in the plug. Replacement covers are available from your dealer. If the fitted plug is not suitable for the power points in your house or the cable is not long enough to reach a power point, you should obtain a suitable safety approved extension lead or consult your dealer for assistance.

However, if there is no alternative to cutting off the plug, remove the fuse and then safely dispose of the plug. Do not connect the plug to a mains socket as there is a risk of shock hazard from the bared flexible cord. Never attempt to insert bare wires directly into a mains socket. A plug and fuse must be used at all times.

IMPORTANT

The wires in the mains lead are coloured in accordance with the following code:– BLUE = NEUTRAL BROWN = LIVE As these colours may not correspond to the coloured markings identifying the terminals in your plug, proceed as follows:– The wire coloured BLUE must be connected to the terminal marked with the letter N or coloured BLUE or BLACK. The wire coloured BROWN must be connected to the terminal marked with the letter L or coloured BROWN or RED.

WARNING : DO NOT CONNECT EITHER WIRE TO THE EARTH TERMINAL WHICH IS MARKED WITH THE LETTER E OR BY THE EARTH SYMBOL , OR COLOURED GREEN OR GREEN AND YELLOW.

PRECAUTIONS

1. Ensure that the AC power supply in your house complies with the power requirements listed on the identification sticker located on the bottom of your product. Install your product horizontally, on a suitable base (furniture), with enough space around it for ventilation (7~10 cm). Make sure the ventilation slots are not covered. Do not place the unit on amplifiers or other equipment which may become hot. This unit is designed for continuous use. To fully turn off the unit, disconnect the AC plug from the wall outlet. Unplug the unit if you intend to leave it unused for a long period of time.

2. During thunderstorms, disconnect the AC plug from the wall outlet. Voltage peaks due to lightning could damage the unit.
3. Do not expose the unit to other heat sources. This could lead to overheating and cause the unit to malfunction.
4. Protect the product from excess heat (e.g. a fireplace) or equipment creating strong magnetic or electric fields. Unplug the power cable from the AC wall socket if the unit malfunctions. Your product is not intended for industrial use. It is for personal use only. Condensation may occur if your product has been stored in cold temperatures. If transporting the unit during the winter, wait approximately 2 hours until the unit has reached room temperature before using.
5. The battery used with this product contains chemicals that are harmful to the environment. Do not dispose of the battery in the general household trash. Do not expose the battery to excess heat or fire. Do not short circuit, disassemble, or overheat the battery.
CAUTION : Danger of explosion if the battery is replaced incorrectly. Replace only with the same or equivalent type.

DURABILITY

- The Soundbar provides the robust durability by IP55 so that it can be used in outdoor environment (when installed and used as per the instructions in this User Manual).
- The remote control of this product provides durability by IP56.

Protection against solids	IP		Protection against water
	5	5	
No protection	0	0	No protection
Solids > 50 mm	1	1	Vertically falling water
Solids > 12 mm	2	2	Vertically water - enclosure tilted 15°
Solids > 2.5 mm	3	3	Sprayed water 60° from vertical
Solids > 1.0 mm	4	4	Splashed water from all directions
Dust Protected	5	5	Hosing jets from all directions
Dust tight	6	6	Strong hosing jets from all directions
-		7	Temporary Immersion: 1 m for 30 minutes
-		8	Immersion: manufacturer defined depth and time

Despite the IP55 and IP56 ratings, your Soundbar and remote control are not impervious to water damage in any situation. To help prevent damage to your products, avoid the products being subjected to:

- Water projected by a source greater than 6.3 mm against enclosure from any direction or submersion in water.
- Water projected at greater than 30 kPa (4.4 psi) with a water volume greater than 12.5 litres/minute for more than 3 minutes and extreme weather conditions.

CONTENTS

01	Checking the Components	7
	Inserting Batteries before using the Remote Control (AAA batteries X 2)	8
02	Product Overview	9
	Front Panel / Bottom Panel of the Soundbar	9
	Rear Panel of the Soundbar	10
03	Using the Remote Control	11
	How to Use the Remote Control	11
	Using the Hidden Buttons (Buttons with more than one function)	14
	Output specifications for the different sound effect modes	14
	Adjusting the Soundbar volume with a TV remote control	15
04	Connecting the Soundbar	16
	Connecting Electrical Power	16
	How to mount the AC/DC adapter	16
05	Installing the Wall Mount	17
	Installation Precautions	17
	Method 1. TV mount	17
	Method 2. Wall mount	20
06	Using a wired connection to the TV	22
	Connecting using an Optical Cable	22
07	Using a wireless connection to the TV	24
	Method 1. Connecting via Bluetooth	24
	Method 2. Connecting via Wi-Fi	26

08	Connecting an External Device	27
	Connecting using an Optical Cable	27
09	Connecting a Mobile Device	28
	Method 1. Connecting via Bluetooth	28
	Method 2. Connecting via Wi-Fi (Wireless Network)	31
	Using the Tap Sound	32
10	Connecting an Amazon product	33
	Connect and use with an Amazon product (Amazon Echo)	33
	Use voice commands to control the Soundbar	33
11	Software Update	34
	Auto Update	34
	USB Update	34
	Initialisation	34
12	Troubleshooting	35
13	Licence	36
14	Open Source Licence Notice	37
15	Important Notes About Service	37
16	Specifications and Guide	38
	Specifications	38

01 CHECKING THE COMPONENTS

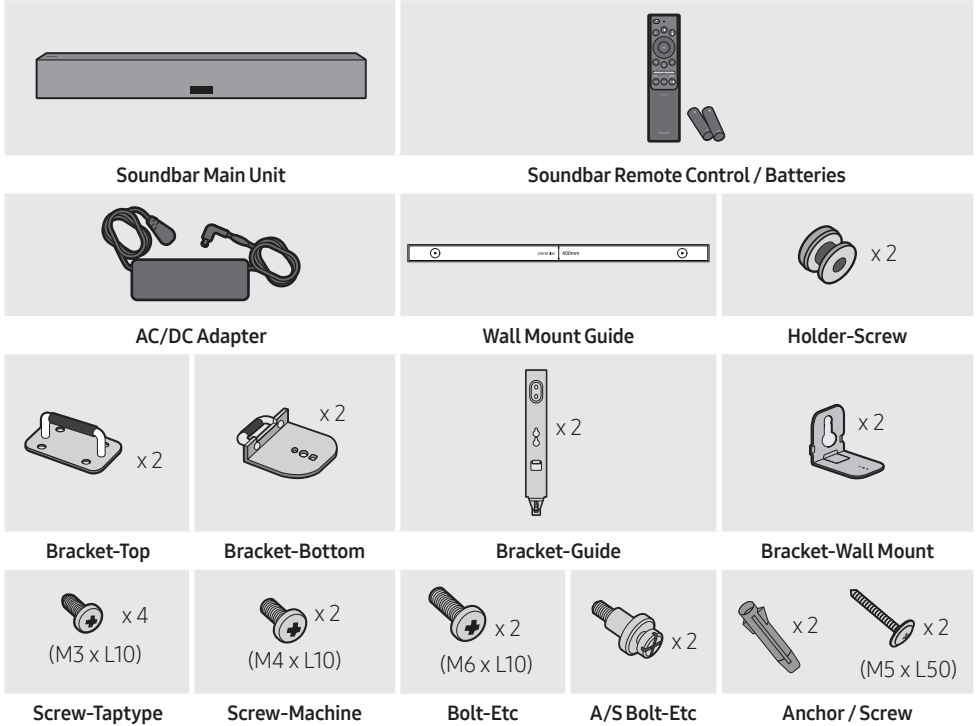

- For more information about the power supply and power consumption, refer to the label attached to the product. (Label: Bottom of the Soundbar Main Unit)
- To purchase additional components or optional cables, contact a Samsung Service Centre or Samsung Customer Care.
- For Soundbar wall mounting components, see pages 17-21.
- This Soundbar is intended only for TV mount or wall mount.
- Design, specifications, and App screen are subject to change without prior notice.
- The appearance of the accessories may differ slightly from the illustrations above.

Inserting Batteries before using the Remote Control (AAA batteries X 2)

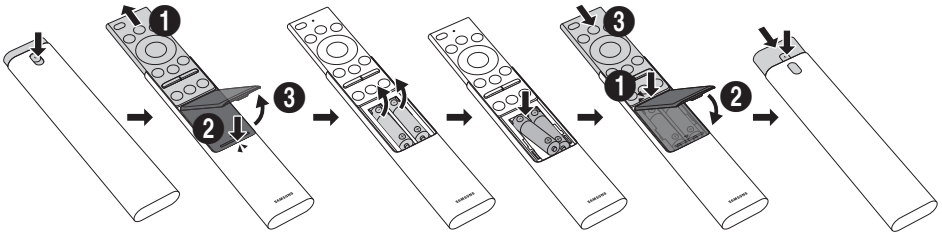

1. Press the ▲ button at the top rear of the Soundbar remote control. The body will pop out slightly from the body cover.
2. Turn the remote over, push the body of the remote upwards until the battery compartment is revealed, and then remove the battery cover.
3. If there are batteries in the remote, to remove the existing batteries.
4. Insert two new batteries (1.5V AAA type) into the battery compartment making sure that the batteries' polarities (+, -) are oriented correctly.
5. Once the batteries have been inserted, attach the battery cover and then slide down the body of the remote.
6. Turn the remote over, press and hold the ▲ button on the top rear, and then slide the body of the remote down into place.
 - Alkaline batteries are recommended for longer battery life.

02 PRODUCT OVERVIEW

Front Panel / Bottom Panel of the Soundbar

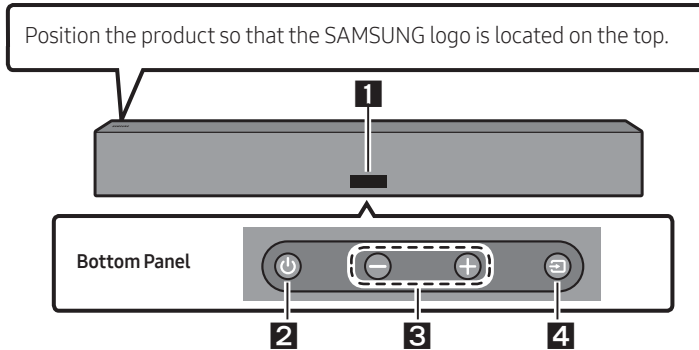

1	Display Displays the product's status and current mode.								
2	⏻ (Power) Button Turns the power on and off.								
3	- + (Volume) Button Adjusts the volume.								
4	📶 (Source) Button Selects the source input mode. <table border="1"><thead><tr><th>Input mode</th><th>Display</th></tr></thead><tbody><tr><td>Optical Digital input</td><td>D.IN</td></tr><tr><td>Wi-Fi mode</td><td>WIFI</td></tr><tr><td>BLUETOOTH mode</td><td>BT</td></tr></tbody></table>	Input mode	Display	Optical Digital input	D.IN	Wi-Fi mode	WIFI	BLUETOOTH mode	BT
Input mode	Display								
Optical Digital input	D.IN								
Wi-Fi mode	WIFI								
BLUETOOTH mode	BT								

- When you plug in the AC cord, the power button will begin working in 4 to 6 seconds.
- When you turn on this unit, there will be a 4 to 5 second delay before it produces sound.
- If you hear sounds from both the TV and Soundbar, go to the **Settings** menu for the TV audio and change the TV speaker to **External Speaker**.

Rear Panel of the Soundbar

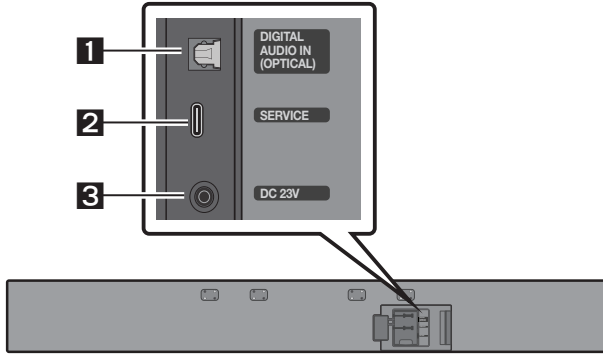







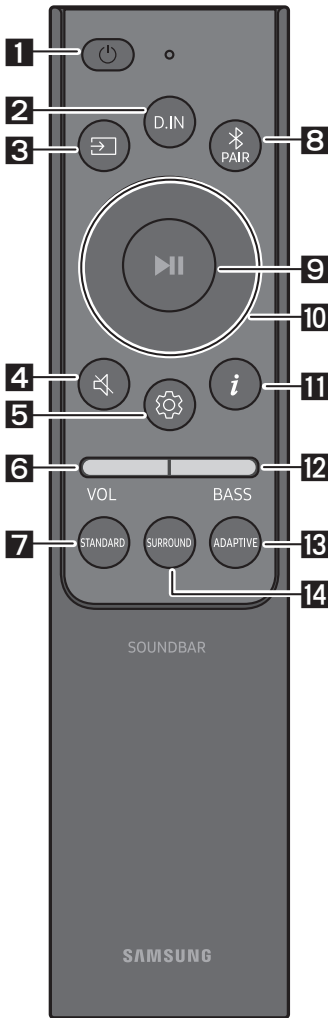

1	DIGITAL AUDIO IN (OPTICAL) Connect to the digital (optical) output of an external device. (See page 27)
2	SERVICE Connect a USB storage device to upgrade the product's software.
3	DC 23V (Power Supply In) Connect the AC/DC power adaptor. (See page 16)









- When disconnecting the power cable of the AC/DC power adaptor from a wall outlet, pull the plug. Do not pull the cable.
- Do not connect this unit or other components to an AC outlet until all connections between components are complete.

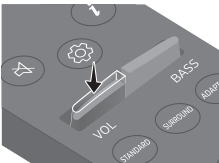

03 USING THE REMOTE CONTROL

How to Use the Remote Control

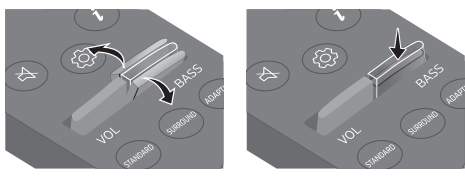

<p>1</p>  <p>Power</p>	<p>Turns the Soundbar on and off.</p> <ul style="list-style-type: none"> • Auto Power Down Function The unit turns off automatically in the following situations: <ul style="list-style-type: none"> – In D.IN / Wi-Fi / BT mode if there is no audio signal for 18 minutes.
<p>2</p>  <p>D.IN</p>	<p>Press to enter the “D.IN” mode.</p>
<p>3</p>  <p>Source</p>	<p>Press to select a source connected to the Soundbar.</p>
<p>4</p>  <p>Mute</p>	<p>Press the  (Mute) button to mute the sound. Press it again to unmute the sound.</p>
<p>5</p>  <p>Sound Control</p>	<p>When pressed, the setting items such as TREBLE, or SYNC are displayed in sequence. The desired item can be adjusted using the Up/Down buttons.</p> <ul style="list-style-type: none"> – To adjust the TREBLE volume, select Sound Control → TREBLE, and then use the Up/Down buttons to adjust the volume within a -6 to +6 range. – Press and hold the  (Sound Control) button for about 5 seconds to adjust the sound for each frequency band. 150Hz, 300Hz, 600Hz, 1.2kHz, 2.5kHz, 5kHz, and 10kHz are selectable using the Left/Right buttons and each can be adjusted to a setting between -6 to +6 using the Up/Down buttons. (Make sure the Sound mode is set to “STANDARD”.) – If the video on the TV and audio from the Soundbar are not synchronised, select SYNC in Sound Control, and then set the audio delay between 0~300 milliseconds by using the Up/Down buttons. – SYNC is only supported for some functions.

<p>6</p>	<p> VOLUME</p>	<div style="display: flex; justify-content: space-around;">   </div> <p>Push the button up or down to adjust the volume.</p> <ul style="list-style-type: none"> • Mute Press the VOL button to mute the sound. Press it again to unmute the sound.
<p>7</p>	<p> STANDARD</p>	<p>Press this button to outputs the original sound.</p>
<p>8</p>	<p> Bluetooth PAIR</p>	<p>Switch the Soundbar to Bluetooth pairing mode. Press the button and wait for the “BT PAIRING” screen to connect to a new Bluetooth device.</p>
<p>9</p>	<p> Play / Pause</p>	<p>You can also play or pause music by pressing the button.</p>
<p>10</p>	<p> Up/Down/ Left/Right</p>	<div style="display: flex; align-items: center;">  <div style="margin-left: 20px;"> <p>Press the indicated areas to select Up/Down/Left/Right.</p> <p>Press Up/Down/Left/Right on the button to select or set functions.</p> <ul style="list-style-type: none"> • Repeat To use the Repeat function, press the Up button. • Music Skip Press the Right button to select the next music file. Press the Left button to select the previous music file. </div> </div>
<p>11</p>	<p> Info</p>	<p>When pressed, the information for the connected sources and Bluetooth devices appears.</p>

12	 BASS	 <p>Push this button up or down to adjust the bass volume within a -6 to +6 range.</p>
13	 ADAPTIVE	<p>Press this button to analyzes the content in real time and automatically provides the optimal sound field based on the characteristics of the content.</p>
14	 SURROUND	<p>Press this button to provide a wider sound stage than standard.</p>

Using the Hidden Buttons (Buttons with more than one function)

Hidden Button		Reference page
Remote Control Button	Function	
BASS (Up)	TV remote control On/Off (Standby)	page 15
 (Sound Control)	7 Band EQ	page 11

Output specifications for the different sound effect modes

Effect	Input	Output
STANDARD	2.0 ch	2.0 ch
	5.1 ch	3.0 ch
SURROUND	2.0 ch	3.0 ch
	5.1 ch	3.0 ch
ADAPTIVE	2.0 ch	2.0 ch
	5.1 ch	3.0 ch

Adjusting the Soundbar volume with a TV remote control

Adjust the Soundbar volume using the TV's remote control.

- This function can be used with IR remote controls only. Bluetooth remote controls (remote controls that require pairing) are not supported.
- Set the TV speaker to **External Speaker** to use this function.
- Manufacturers supporting this function:
VIZIO, LG, Sony, Sharp, PHILIPS, PANASONIC, TOSHIBA, Hisense, RCA

1. Turn Off the Soundbar.
2. Push up and hold the **BASS** button for 5 seconds.
Each time you push the **BASS** button up and hold it for 5 seconds, the mode switches in the following order: "**SAMSUNG-TV REMOTE**" (Default mode), "**OFF-TV REMOTE**", "**ALL-TV REMOTE**".

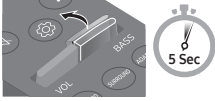
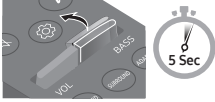
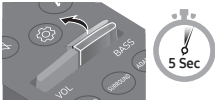
Remote Control Button	Display	Status
	(Default mode) SAMSUNG-TV REMOTE	Enable a Samsung TV's IR remote control.
	OFF-TV REMOTE	Disable the TV remote control.
	ALL-TV REMOTE	Enable a third-party TV's IR remote control.

04 CONNECTING THE SOUNDBAR

Connecting Electrical Power

Connect the Soundbar to an electrical outlet in the following order:

1. Connect the AC/DC adapter to the Soundbar.
 2. Connect the power cord to a wall socket.
- For more information about the required electrical power and power consumption, refer to the label attached to the product.
(Label: Bottom of the Soundbar Main Unit)

CAUTION ! TO REDUCE THE RISK OF FIRE OR ELECTRIC SHOCK, DO NOT EXPOSE AC/DC ADAPTOR TO RAIN OR MOISTURE.

AC/DC Adapter

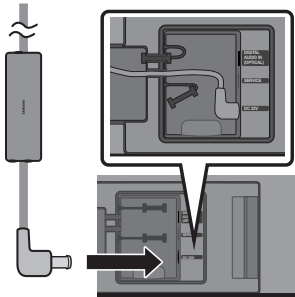

Rear of the Soundbar Main Unit

- While the cable is not in use, seal it with the silicone.

NOTES

- If you unplug and reconnect the power cord when the product is turned on, the Soundbar turns on automatically.
- Never forcibly pull the power cord of AC/DC adapter.
- When installing the AC/DC adapter horizontally, place it with the Samsung logo facing upward.

How to mount the AC/DC adapter

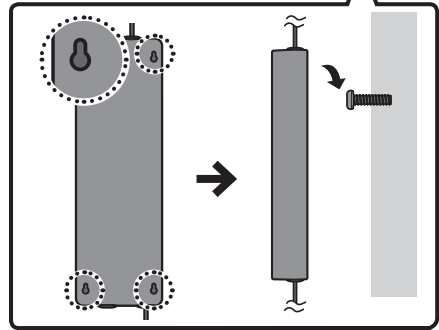
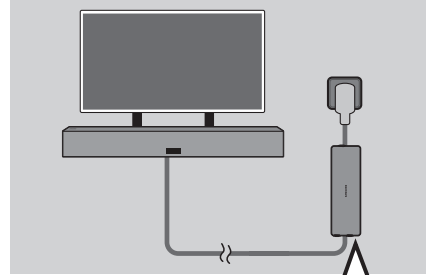

- Tighten 2 or 4 screws (not supplied) on the wall or table and then insert them into the grooves on the rear of the AC/DC adapter. You cannot install the adapter directly on the floor.
- For the mounting screws, see the following figures.

Recommended Screw specification (not supplied)

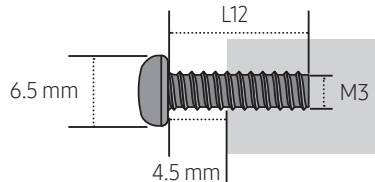

05 INSTALLING THE WALL MOUNT

Method 1. TV mount

Installation Precautions

- Install on a vertical wall only.
- Verify whether the wall is strong enough to support the product's weight. If not, reinforce the wall or choose another installation point.
- Purchase and use the fixing screws or anchors appropriate for the kind of wall you have (plaster board, iron board, wood, etc.). If possible, fix the support screws into wall studs.
- Purchase wall mounting screws according to the type and thickness of the wall you want to mount the Soundbar on.
 - Diameter: M5
 - Length: 35 mm or longer recommended.
- Connect cables from the unit to external devices before you install the Soundbar on the wall.
- Make sure the unit is turned off and unplugged before you install it. Otherwise, it may cause an electric shock.
- When installing the Soundbar, keep away from other heat sources (e.g. a fireplace).
- For the stable use of the product, it should be installed in a place where there is no risk of freezing due to snow accumulation or exposure to rain for a long time.
- When leaving the Soundbar outdoors, dust or foreign substances may accumulate. When not in use, be sure to keep it covered with a cloth or cover.
 - It is recommended to use cover for Weather Resistance against water & dust.
- For more information about TV installation on a wall, refer to the TV's wall mounting guide.
- Samsung does not assume the responsibility for the damage caused by improper installation of the product.
- It is recommended that the Soundbar is installed undercover, protected from extreme weather conditions.

Pre-connection Checklist

- This Soundbar is compatible with the Samsung outdoor TV model called "The Terrace" with the following model names: QN**LST**, GQ**LST**, QA**LST**, QE**LST** (e.g., QN65LST7T)

TV mount Components

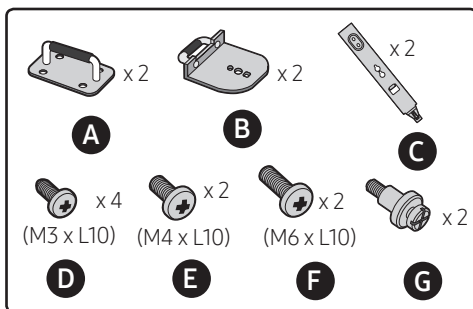

Installation Example

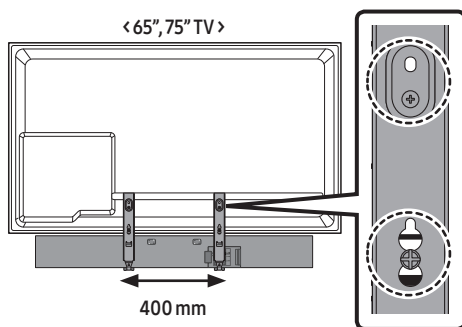

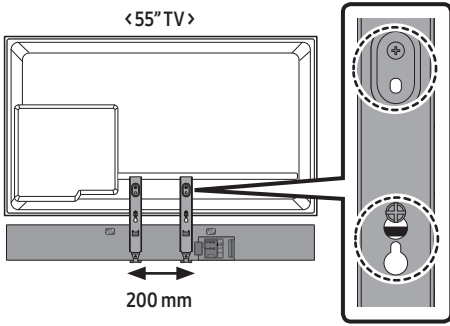

1. < Rear of the Samsung TV >

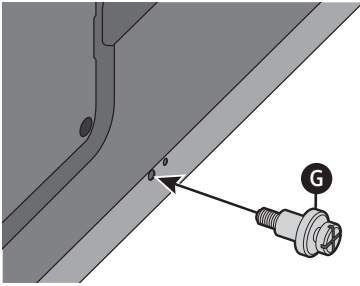

2. < Rear of the Samsung TV >

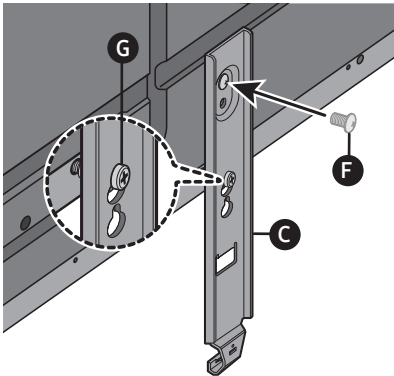

- Tighten the TV with it lying down



3. < Rear of the Soundbar >

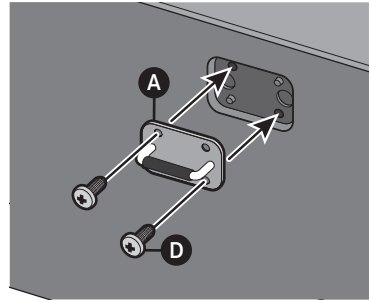

4. < Bottom of the Soundbar >

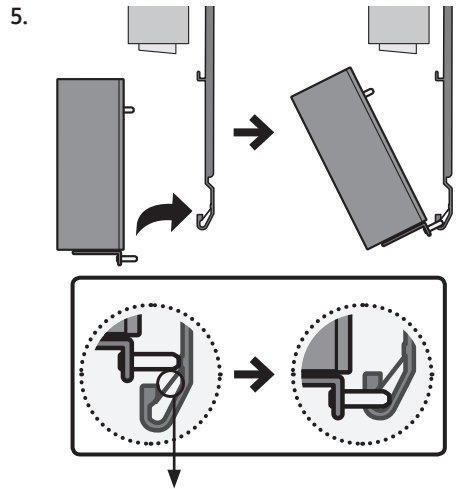
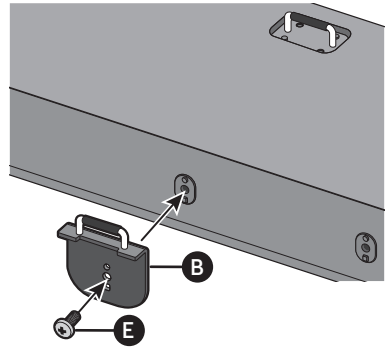

Deviation preventing plate

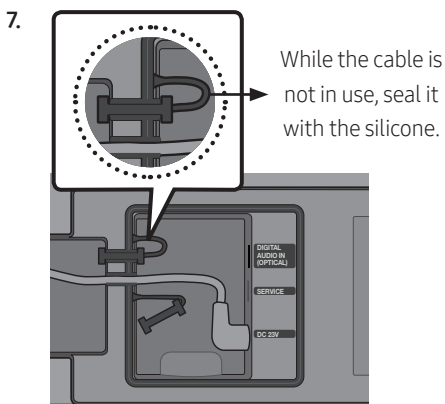
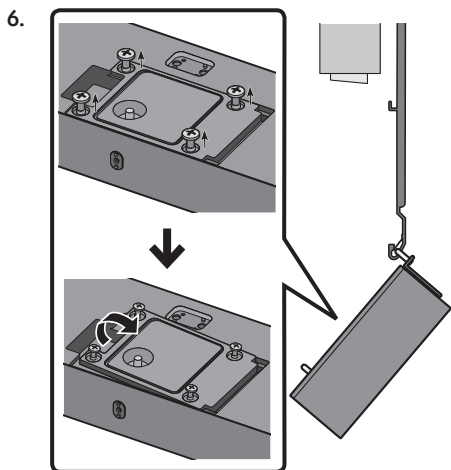

- After the cable is connected, close its cover and then tighten the loosened screws.

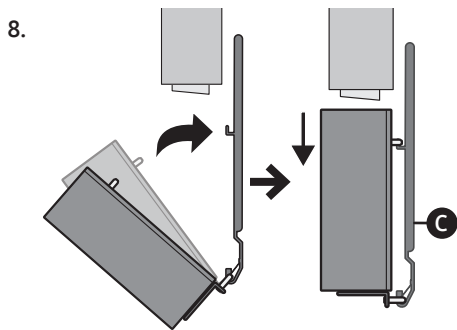

- Before hooking up the Soundbar to **C**, slightly lift the product and then push it down for assembly.

NOTES

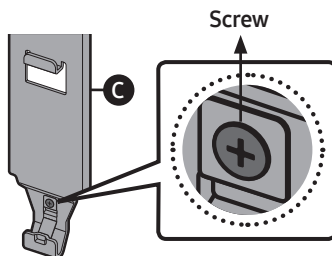

- When separating the Soundbar from the TV, please loosen the screw on the **C**.
- When removing the Soundbar, be careful because the deviation preventing plate may be deformed.

Method 2. Wall mount

Wallmount Components

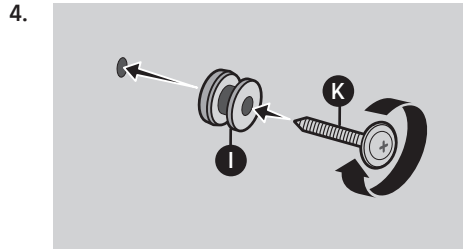
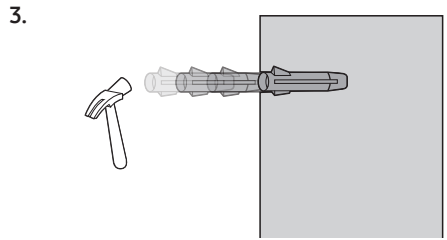
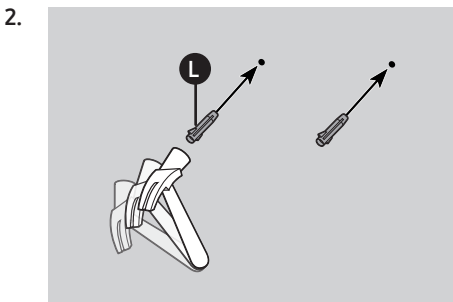
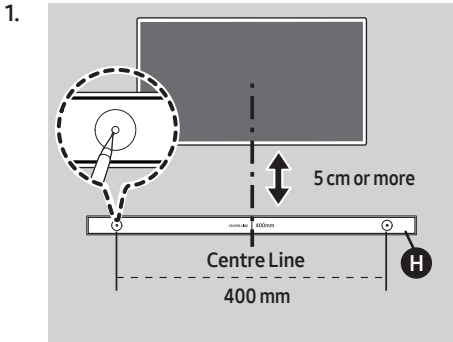
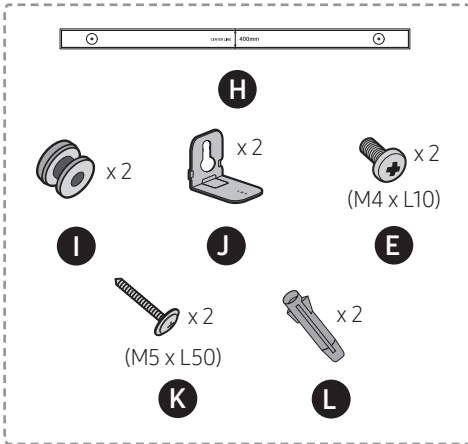

• Recommended torque : 10-12 kgf.cm

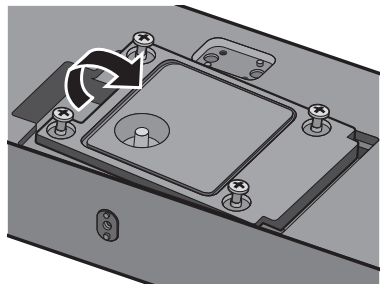
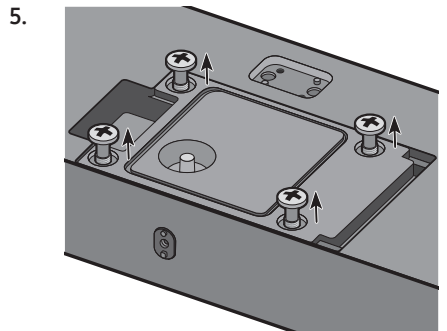

6.

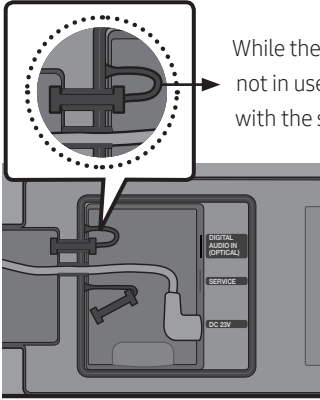

While the cable is not in use, seal it with the silicone.

- After the cable is connected, close its cover and then tighten the loosened screws.

7.

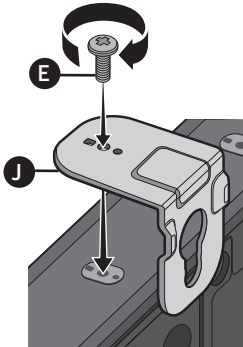

8.

Rear of the Soundbar

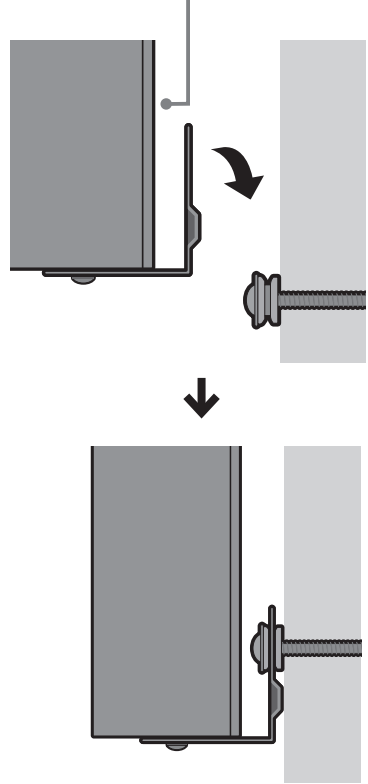

06 USING A WIRED CONNECTION TO THE TV

Connecting using an Optical Cable

When the audio in a broadcast is encoded in Dolby Digital and the “Digital Output Audio Format” on your TV is set to PCM, we recommend that you change the setting to Dolby Digital. When the setting on the TV is changed, you will experience better sound quality. (The TV menu may use different words for Dolby Digital and PCM depending on the TV manufacturer.)

Pre-connection Checklist

- When using the Soundbar outdoors, it is recommended to connect an Optical cable for smooth sound output.
- To purchase any optical cable separately, contact the nearest dealer or Samsung Service Centre.
- The optical cable provided with the product is designed to meet the specification (4 mm) for Water Resistance. When using an optical cable purchased from other site, the Water Resistance function may not work properly.
- When you use an optical cable and the terminals have covers, be sure to remove the covers.

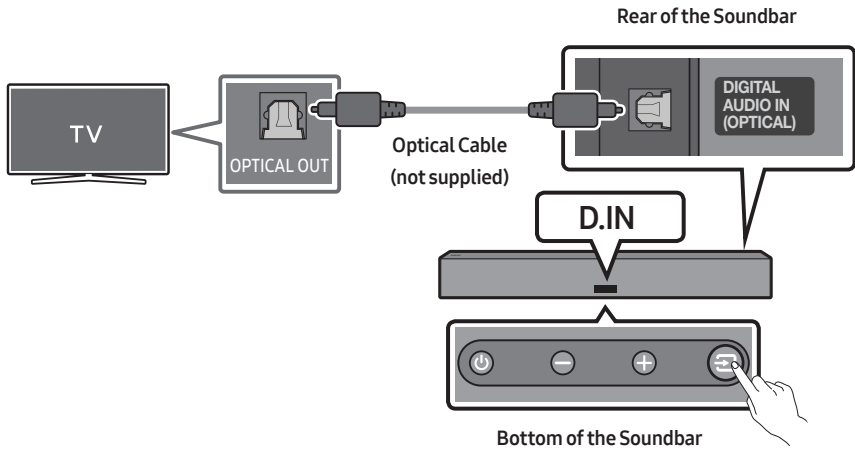

1. With the TV and Soundbar turned off, connect the **DIGITAL AUDIO IN (OPTICAL)** port on the Soundbar and the OPTICAL output port on the TV with the optical cable (not supplied), as shown in the figure.
2. Turn on the Soundbar and TV.
3. Select “**D.IN**” mode by pressing the  (**Source**) button on the bottom of the Soundbar or the **D.IN** button on the Soundbar remote control.
4. The TV sound is output from the Soundbar.

07 USING A WIRELESS CONNECTION TO THE TV

Pre-connection Checklist

- When used outdoors, wireless performance may degrade. Accordingly, use the provided optical cable if possible.

Method 1. Connecting via Bluetooth

When a Samsung TV is connected using Bluetooth, you can hear stereo sound without the hassle of cabling.

- Only one Samsung TV can be connected at a time.
- Samsung TV that supports Bluetooth can be connected. Check the specifications of your TV.

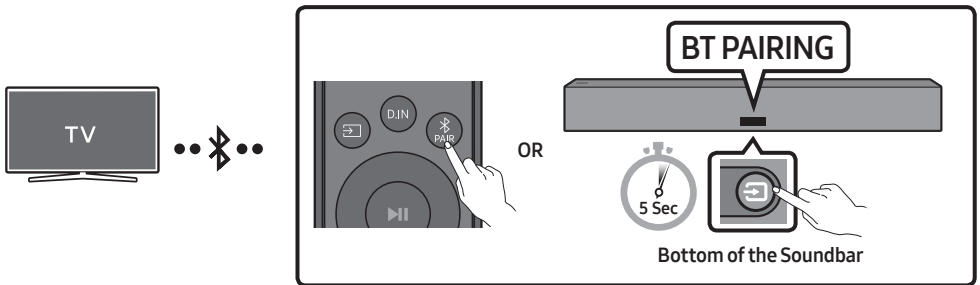

The initial connection

1. Press the **PAIR** button on the Soundbar remote control to enter the **"BT PAIRING"** mode.

- (OR)** a. Press the **Source** button on the bottom panel and then select **"BT"**.

"BT" changes to **"BT PAIRING"** in a few seconds automatically or changes to **"BT READY"** if there is a connect record.

- b. When **"BT READY"** appears, press and hold the **Source** button on the bottom panel of the Soundbar for more than 5 seconds to display **"BT PAIRING"**.

2. Select Bluetooth mode on the Samsung TV.

(e.g. Home (🏠) → Settings (⚙️) → Sound → Sound Output → Bluetooth Speaker List → [AV] Samsung Soundbar LST70T (Bluetooth))

3. Select “[AV] Samsung Soundbar LST70T” from the list on TV’s screen.

An available Soundbar is indicated with “Needs Pairing” or “Paired” on the TV’s Bluetooth device list. To connect the Samsung TV to the Soundbar, select the message, and then establish a connection.

- When the Samsung TV is connected, [TV] Name → “BT” appears on the Soundbar’s front display.

4. You can now hear Samsung TV sound from the Soundbar.

- After you have connected the Soundbar to your Samsung TV the first time, use the “BT READY” mode to reconnect.

If the device fails to connect



- If you have an existing Soundbar (e.g., [AV] Samsung Soundbar LST70T) on the list of speakers on the Samsung TV, delete it.
- Then repeat steps 1 through 3.

Disconnecting the Soundbar from the Samsung TV

Press the  (Source) button on the bottom panel or on the remote control and switch to any mode but “BT”.

- Disconnecting takes time because the Samsung TV must receive a response from the Soundbar. (The time required may differ, depending on the Samsung TV model.)

What is the difference between BT READY and BT PAIRING?

- **BT READY** : In this mode, you can reconnect any Samsung TV or mobile device that was connected before.
- **BT PAIRING** : In this mode, you can connect a new device to the Soundbar. (Press the  PAIR button on the Soundbar remote control or press and hold the  (Source) button on the bottom of the Soundbar for more than 5 seconds while the Soundbar is in “BT” mode.)

Notes on Bluetooth connection

- Locate a new device within 1 m to connect via Bluetooth communication.
- If asked for a PIN code when connecting a Bluetooth device, enter <0000>.
- The Soundbar automatically turns off after 18 minutes in the Ready state.
- The Soundbar may not perform Bluetooth search or connection correctly under the following circumstances:
 - If there is a strong electrical field around the Soundbar.
 - If several Bluetooth devices are simultaneously paired with the Soundbar.
 - If the Bluetooth device is turned off, not in place, or malfunctions.
- Electronic devices may cause radio interference. Devices that generate electromagnetic waves must be kept away from the Soundbar main unit - e.g., microwaves, wireless LAN devices, etc.

Method 2. Connecting via Wi-Fi

Pre-connection Checklist

- Wi-Fi connection is available only on Samsung TV.
- Check whether **the wireless router (Wi-Fi)** is turned on and the **TV is connected to the router**.
- The TV and Soundbar must be connected to the same wireless network (Wi-Fi).
- If your wireless router (Wi-Fi) uses a DFS channel, you will not be able to establish a Wi-Fi connection between the TV and Soundbar. Contact your Internet service provider for details.
- Because the menus may differ depending on the year of manufacture, refer to your TV manual.
- To connect the TV to the Soundbar via Wi-Fi, connect the Soundbar to the wireless router first. See page 31 for details on how to establish a Wi-Fi connection.

1. For more information about Wi-Fi connection to the Soundbar, see page 31, “**Method 2. Connecting via Wi-Fi (Wireless Network)**”.

2. Change the input source of the TV by using the Audio menu to Soundbar.

- **Samsung TVs released in 2017 or later**

Home (🏠) → Settings (⚙️) → Sound → Sound Output → [AV] Samsung Soundbar LST70T (Wi-Fi)

08 CONNECTING AN EXTERNAL DEVICE

Connecting using an Optical Cable

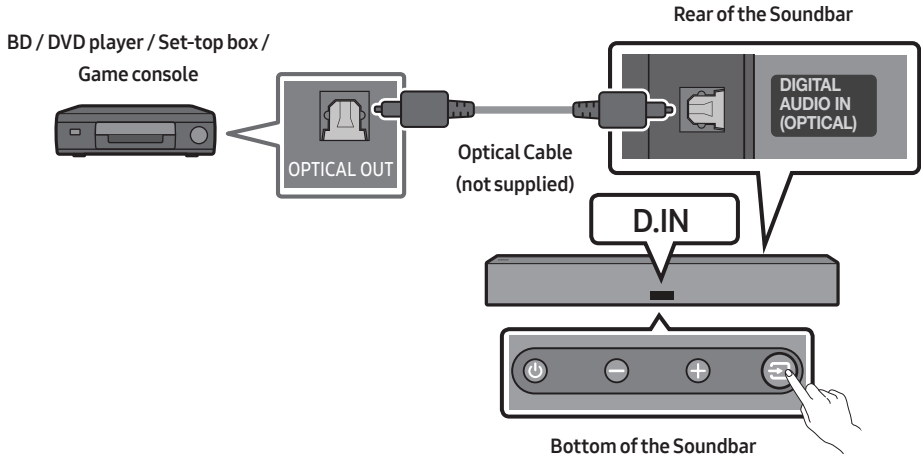

1. Use an optical cable (not supplied) to connect the **DIGITAL AUDIO IN (OPTICAL)** on the Soundbar main and the **OPTICAL OUT** port on the external device.
2. Turn on the Soundbar and external device.
3. Select “**D.IN**” mode by pressing the  (**Source**) button on the bottom of the Soundbar or the **D.IN** button on the Soundbar remote control.
4. Your Soundbar will play sounds from the external device.

09 CONNECTING A MOBILE DEVICE

Method 1. Connecting via Bluetooth

When a mobile device is connected using Bluetooth, you can hear stereo sound without the hassle of cabling.

- When you connect a paired Bluetooth device with the Soundbar off, the Soundbar automatically turns on.

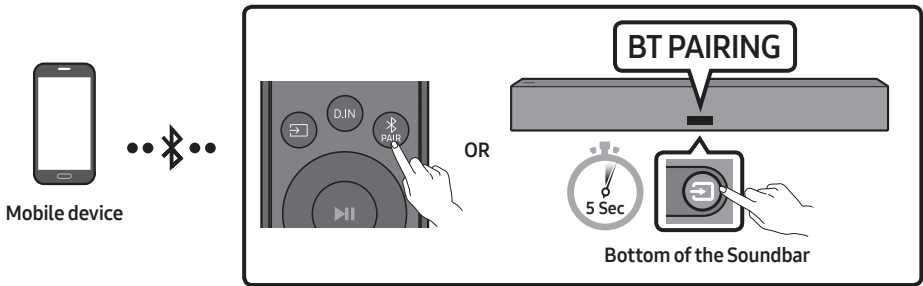

The initial connection

- When connecting to a new Bluetooth device, make sure the device is within 1 m distance.

1. Press the **PAIR** button on the Soundbar remote control to enter the “**BT PAIRING**” mode.

(OR) a. Press the **Source** button on the bottom panel and then select “**BT**”.
“**BT**” changes to “**BT PAIRING**” in a few seconds automatically or changes to “**BT READY**” if there is a connect record.

b. When “**BT READY**” appears, press and hold the **Source** button on the bottom panel of the Soundbar for more than 5 seconds to display “**BT PAIRING**”.

2. On your device, select “[AV] Samsung Soundbar LST70T” from the list that appears.

- When the Soundbar is connected to the Mobile device, [Mobile Device Name] → “**BT**” appears in the front display.



3. Play music files from the device connected via Bluetooth through the Soundbar.

- After you have connected the Soundbar to your mobile device the first time, use the “**BT READY**” mode to reconnect.

If the device fails to connect

- If you have an existing Soundbar (e.g., “[AV] Samsung Soundbar LST70T”) in the list of speakers on the Mobile device, delete it.
- Repeat steps 1 and 2.

What is the difference between BT READY and BT PAIRING?

- **BT READY** : In this mode, you can reconnect any Samsung TV or mobile device that was connected before.
- **BT PAIRING** : In this mode, you can connect a new device to the Soundbar. (Press the  **PAIR** button on the Soundbar remote control or press and hold the  (**Source**) button on the bottom of the Soundbar for more than 5 seconds while the Soundbar is in “**BT**” mode.)

Notes on Bluetooth connection

- Locate a new device within 1 m to connect via Bluetooth communication.
- If asked for a PIN code when connecting a Bluetooth device, enter <0000>.
- The Soundbar automatically turns off after 18 minutes in the Ready state.
- The Soundbar may not perform Bluetooth search or connection correctly under the following circumstances:
 - If there is a strong electrical field around the Soundbar.
 - If several Bluetooth devices are simultaneously paired with the Soundbar.
 - If the Bluetooth device is turned off, not in place, or malfunctions.
- Electronic devices may cause radio interference. Devices that generate electromagnetic waves must be kept away from the Soundbar main unit - e.g., microwaves, wireless LAN devices, etc.
- The Soundbar supports SBC data (44.1kHz, 48kHz).
- Connect only to a Bluetooth device that supports the A2DP (AV) function.
- You cannot connect the Soundbar to a Bluetooth device that supports only the HF (Hands Free) function.
- When connecting the Soundbar to a Bluetooth device, place them as close to each other as possible.
- The farther the Soundbar and Bluetooth device are from each other, the lower the sound quality will become.

The Bluetooth connection may break when the devices are out of the effective range.
- The Bluetooth connection may not function as intended in areas with poor reception.

- A Bluetooth device may experience noise or malfunction under in the following conditions:
 - When the body is in contact with the signal transceiver on the Bluetooth device or Soundbar
 - In corners or when there is an obstacle in proximity, such as a wall or partition, where electrical changes may occur.
 - When exposed to radio interferences by other products operating on the same frequency ranges, such as medical equipment, microwave ovens, and wireless LAN devices.
 - Obstacles such as doors and walls may still impact the sound quality even when the devices are within the effective range.
- Note that your Soundbar cannot be paired with other Bluetooth devices while using the Bluetooth option.
- This wireless device may cause electrical interference during operation.

Disconnecting the Bluetooth device from a Soundbar

You can disconnect a Bluetooth device from the Soundbar. For instructions, see the Bluetooth device's user manual.

- The Soundbar will be disconnected.
- When the Soundbar is disconnected from the Bluetooth device, the Soundbar will display "**BT DISCONNECTED**" on the front display.

Disconnecting the Soundbar from the Bluetooth device

Press the  (**Source**) button on the bottom panel or on the remote control, and then change to any mode except "**BT**".

- Disconnecting takes time because the Bluetooth device must receive a response from the Soundbar. (Disconnection time may differ, depending on the Bluetooth device)
- When the Soundbar is disconnected from the Bluetooth device, the Soundbar will display "**BT DISCONNECTED**" on the front display.

Method 2. Connecting via Wi-Fi (Wireless Network)

To connect a Soundbar to a mobile device via a wireless network (Wi-Fi), the **SmartThings** app is required.

The initial connection

1. Install and launch the **SmartThings** app from your mobile device (smartphone or tablet).
2. On the app, follow the screen instructions to add the Soundbar.
 - The automatic pop-up (the second screenshot below) may not show on some devices. If the pop-up does not appear, press “+” on the **Home** screen. The Soundbar is added to the app.

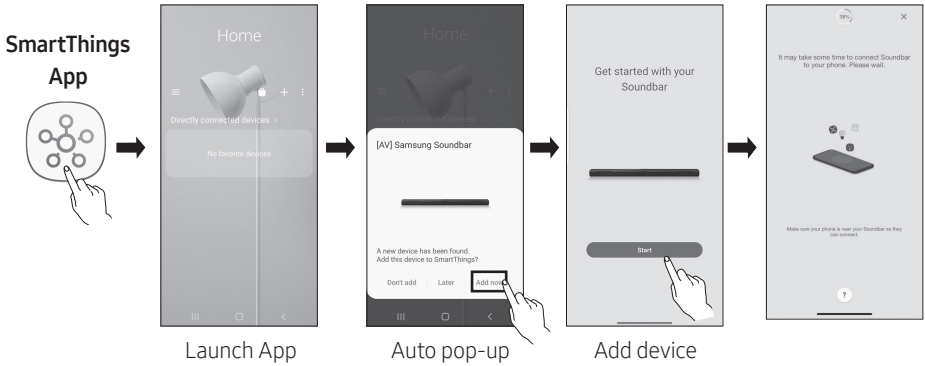

Using the Tap Sound

Tap the Soundbar with your mobile device to play the sound of content on the mobile device through the Soundbar.

- This function may not be supported, depending on the mobile device.
- This function is only compatible with Samsung mobile devices with Android 8.1 or later.

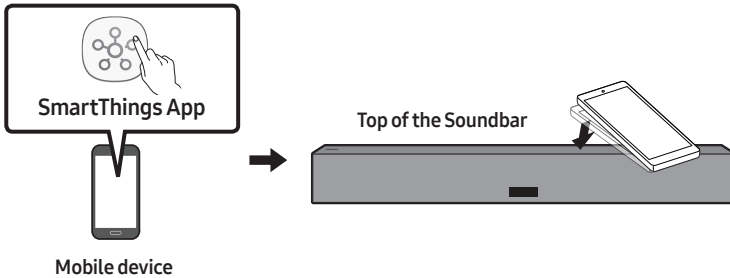

1. Turn on the **Tap Sound** function on your mobile device.
 - For details on how to turn on the function, refer to “**Setting the Tap Sound function**” below.
2. Tap the Soundbar with the mobile device. Select “**Start now**” in the displayed message window. A connection is established between the mobile device and Soundbar via Bluetooth.
3. Play the sound of content on the mobile device through the Soundbar.
 - This function connects a mobile device to the Soundbar via Bluetooth by detecting vibration that occurs when the device touches the Soundbar.
 - Make sure the mobile device does not tap a sharp corner of the Soundbar. The Soundbar or mobile device may become scratched or damaged.
 - It is recommended that the mobile device be covered with a case. Lightly tap the wide area in the upper portion of the Soundbar, without using excessive force.
 - To use this function, update the **SmartThings** app to the latest version. The function may not be supported, depending on the app version.

Setting the Tap Sound function

Use the **SmartThings** app to turn on the **Tap View, Tap Sound** function.

1. On the mobile device, run the **SmartThings** app.
2. Select (☰ → ⚙) in the **SmartThings** app screen displayed on the mobile device.
3. Set “**Tap View, Tap Sound**” to On to allow the function to work when a mobile device moves close to the Soundbar. The function is turned on.

NOTES

- When the mobile device is in power-saving mode, the **Tap Sound** function does not work.
- The **Tap Sound** function may not work if there are devices near the Soundbar that cause radio interference such as electric devices. Make sure devices that may cause radio interference are placed at a sufficient distance away from the Soundbar.

10 CONNECTING AN AMAZON PRODUCT

- This feature may not be available in some countries.
- This service is provided by Amazon and can be terminated at any time. Samsung does not assume responsibility for service availability.
- **Amazon Alexa** app screen is subject to change without prior notice.

Connect and use with an Amazon product (Amazon Echo)

Use an Amazon Echo product to control your Soundbar and enjoy music services provided by Amazon Echo.

NOTE

- Confirm that the Soundbar is connected to Wi-Fi. (Refer to "Method 2. Connecting via Wi-Fi (Wireless Network)")

Use voice commands to control the Soundbar

- The Amazon Echo service you can use with your Soundbar is limited to music. Other services provided by Amazon Echo, such as news and weather, can only be accessed through your Amazon Echo product.



Trigger + Command + Speaker name

* To use voice commands for the Soundbar named "Living room"

Action	Voice Command
To set the volume level to 5	"Alexa Set the volume to 5 on Living room"
To increase the volume level	"Alexa Volume up on Living room"
To mute the sound	"Alexa Mute on Living room"
To listen to a radio station named KISS FM	"Alexa Play Kiss FM on Living room"
To play the next song	"Alexa Next song on Living room"
To stop the audio	"Alexa Stop on Living room"
To turn the audio off	"Alexa Turn off on Living room"

11 SOFTWARE UPDATE

Auto Update

When the Soundbar is connected to the Internet, software updates automatically occur even when the Soundbar is turned off.

- To use the Auto Update function, the Soundbar must be connected to the Internet. The Wi-Fi connection to the Soundbar will be terminated if the Soundbar's power cord is disconnected or the power is cut off. If the power is cut off, when the power comes back on or you reconnect the power cord, turn on the Soundbar, and then reconnect it to the Internet.

USB Update

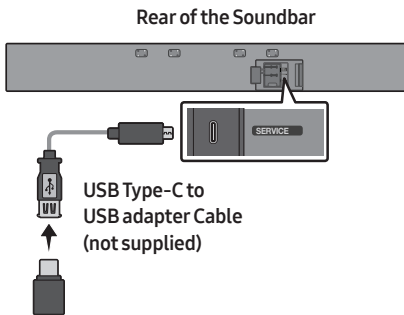

Samsung may offer updates for the Soundbar's system firmware in the future.

When an update is available, you can update the Soundbar by connecting the USB drive that contains the update firmware to the **SERVICE** port of the Soundbar.

1. Go to the Samsung website (www.samsung.com) → search for the model name from the customer support menu option.
 - For more information about update, refer to Upgrade Guide.
2. Download the upgrade file (USB type-C).
3. Unzip the file to create a folder with the file name.
4. Store the created folder in a USB and then connect it to the Soundbar.
5. Turn on the Soundbar. Then the product is updated within 3 minutes with displaying the message, "**UPDATE**".
 - During update, do not turn it off or remove the USB.
 - If "**UPDATE**" does not appear on the display window, remove the power cord from the Soundbar and then reconnect it.
 - When the latest version is installed, no update is performed.
 - Depending on the USB type, update may not be supported.

Initialisation

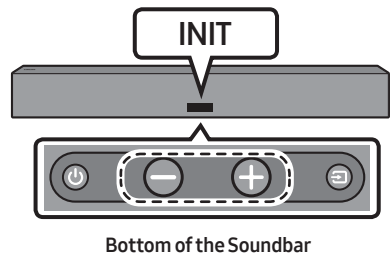

With the Soundbar on, press the **— + (Volume)** buttons on the body at the same time for at least 5 seconds. "**INIT**" appears on the display and then the Soundbar is initialised.

⚠ CAUTION

- All the settings of the Soundbar are initialised. Be sure to perform this only when initialisation is required.

12 TROUBLESHOOTING

Before seeking assistance, check the following.

In case the power is not turned on

- Check whether the power cord of the Soundbar is correctly inserted into the outlet.

In case the functions do not work properly

- After removing the power cord, insert it again.
- Remove the power cord from the external device and try again.
- If there is no signal, the Soundbar automatically turns off after a certain period of time. Turn on the power. (See page 11).

In case the remote control does not work



- Operate the remote control noting the Soundbar closely.
- Replace the batteries with new ones.

In case the Soundbar sound is not output

- The volume of the Soundbar is too low or muted. Adjust the volume.
- When any external device (STB, Bluetooth device, mobile device, etc.) is connected, adjust the volume of the external device.
- For sound output of the TV, select Soundbar. (Samsung TV: Home (🏠) → Settings (⚙️) → Sound → Sound Output → Select Soundbar)

- The cable connection to the Soundbar may not be loose. Remove the cable and connect again.
- Remove the power cord completely, reconnect, and turn the power on.
- Initialise the product and try again. (See page 34.)

In case Bluetooth connection is not possible

- When connecting a new device, switch to “**BT PAIRING**” for connection. (Press the  PAIR button on the remote control or press the  (Source) button on the body for at least 5 seconds.)
- If the Soundbar is connected to another device, disconnect that device first to switch the device.
- Reconnect it after removing the Bluetooth speaker list on the device to connect. (Samsung TV: Home (🏠) → Settings (⚙️) → Sound → Sound Output → Bluetooth Speaker List)
- The automatic TV connection may be disabled. While the Soundbar is in “**BT READY**”, press and hold the  button on the Soundbar remote control for 5 seconds to select **ON-TV CONNECT**. If you see **OFF-TV CONNECT**, press and hold  button again for 5 seconds to switch the selection.
- Remove and reconnect the power plug, then try again.
- Initialise the product and try again. (See page 34.)

In case Bluetooth sound breaking occurs

- Sounds may be breaking due to interference by radio frequency or electronic devices nearby. Keep such devices away from the Soundbar to avoid radio interference. Example: microwave ovens.
- Because the device to connect is far away from the Soundbar, sound breaking may occur. Move the device near the Soundbar.
- If a part of your body is in contact with the Bluetooth transceiver or the product is installed on metal furniture, sound breaking may occur. Check the installation environment and conditions for use.

In case Wi-Fi connection is not possible

- Check whether your wireless router is on.
- Turn off the router, turn it back on, and then try again.
- When the signal of the wireless router is too weak, connection may not be possible. Move the router near the Soundbar or adjust the installed position with no obstacles.
- If your wireless router is new, you will need to reconfigure the speaker's network settings.

In case the Soundbar is not turned on as soon as the TV is turned on

- When you turn off the Soundbar while watching TV, power synchronization with the TV is disabled. First turn off the TV.

13 LICENCE



Manufactured under license from Dolby Laboratories. Dolby, Dolby Audio and the double-D symbol are trademarks of Dolby Laboratories Licensing Corporation.



For DTS patents, see <http://patents.dts.com>. Manufactured under license from DTS, Inc. (for companies headquartered in the U.S./Japan/Taiwan) or under license from DTS Licensing Limited (for all other companies). DTS, Digital Surround, and the DTS logo are registered trademarks or trademarks of DTS, Inc. in the United States and other countries. © 2020 DTS, Inc. ALL RIGHTS RESERVED.



- Use your phone, tablet or computer as a remote control for Spotify. Go to spotify.com/connect to learn how
- The Spotify Software is subject to third party licences found here : <https://www.spotify.com/connect/third-party-licenses>.

14 OPEN SOURCE LICENCE NOTICE

To send inquiries and requests for questions regarding open sources, contact Samsung Open Source (<http://opensource.samsung.com>)

15 IMPORTANT NOTES ABOUT SERVICE

- Figures and illustrations in this User Manual are provided for reference only and may differ from actual product appearance.
- An administration fee may be charged if either
 - (a) an engineer is called out at your request and there is no defect with the product (i.e. where the user manual has not been read).
 - (b) you bring the unit to a repair centre and there is no defect with the product (i.e. where the user manual has not been read).
- You will be informed of the administration fee amount before a technician visits.

16 SPECIFICATIONS AND GUIDE

Specifications

Model Name	HW-LST70T
Weight	6.7 kg
Dimensions (W x H x D)	1220.0 x 140.0 x 53.5 mm
Operating Temperature Range	-31°C to 50°C
Operating Humidity Range	10% to 80%, non-condensing
Storage Temperature Range	-31°C to 50°C
Storage Humidity Range	5% to 95%, non-condensing
AMPLIFIER Rated Output power	(45W x 4) + (10W x 3)
Supported play formats	LPCM 2ch, Dolby Audio™ (supporting Dolby® Digital), DTS
WIRELESS DEVICE OUTPUT POWER Wi-Fi max transmitter power	100mW at 2.4GHz – 2.4835GHz, 200mW at 5.15GHz – 5.25GHz, 100mW at 5.25GHz – 5.35GHz & 5.47GHz – 5.725GHz
WIRELESS DEVICE OUTPUT POWER BT max transmitter power	100mW at 2.4GHz – 2.4835GHz

NOTES

- Samsung Electronics Co., Ltd reserves the right to change the specifications without notice.
- Weight and dimensions are approximate.
- This product may not operate safely under -20°C. It is recommended to connect the power cable to the outlet and after 1 hour, turn on the Soundbar power .
 - Be sure to stay connected to the power in -20°C to -31°C environment.
- Products sold separately from this Soundbar aren't dustproof and waterproof. You can connect a wireless Subwoofer and Rear speaker, which are sold separately. (Subwoofer : SWA-W500, Rear speaker : SWA-9000S) To connect, refer to their manuals.

Overall Standby Power Consumption (W)	3.5W
Wi-Fi Port deactivation method	Press the BASS button on the Soundbar remote control for 30 seconds to turn Wi-Fi On / Off.
Bluetooth Port deactivation method	Press the Info button on the Soundbar remote control for 30 seconds to turn Bluetooth On / Off.

Hereby, Samsung declares that this radio equipment is in compliance with Directive 2014/53/EU and the relevant UK statutory requirements.

The full text of the declaration of conformity is available at the following internet address:
<http://www.samsung.com> go to Support and enter the model name.

This equipment may be operated in all EU countries and in the UK.

The 5GHz WLAN(Wi-Fi or SRD) function of this equipment may only be operated indoors.



[Correct disposal of batteries in this product]

(Applicable in countries with separate collection systems)

This marking on the battery, manual or packaging indicates that the batteries in this product should not be disposed of with other household waste at the end of their working life. Where marked, the chemical symbols Hg, Cd or Pb indicate that the battery contains mercury, cadmium or lead above the reference levels in EC Directive 2006/66.

If batteries are not properly disposed of, these substances can cause harm to human health or the environment.

To protect natural resources and to promote material reuse, please separate batteries from other types of waste and recycle them through your local, free battery return system.



Correct Disposal of This Product (Waste Electrical & Electronic Equipment)

(Applicable in countries with separate collection systems)

This marking on the product, accessories or literature indicates that the product and its electronic accessories (e.g. charger, headset, USB cable) should not be disposed of with other household waste at the end of their working life. To prevent possible harm to the environment or human health from uncontrolled waste disposal, please separate these items from other types of waste and recycle them responsibly to promote the sustainable reuse of material resources.

Household users should contact either the retailer where they purchased this product, or their local government office, for details of where and how they can take these items for environmentally safe recycling.

Business users should contact their supplier and check the terms and conditions of the purchase contract. This product and its electronic accessories should not be mixed with other commercial wastes for disposal.

For information on Samsung's environmental commitments and product specific regulatory obligations e.g. REACH, WEEE, Batteries, visit:
www.samsung.com/uk/aboutsamsung/sustainability/environment/our-commitment/data/

COMMISSION REGULATION (EU) 2019/1782

Ecodesign requirements for external power supplies :
www.samsung.com/global/ecodesign_component



UNITED KINGDOM



EIRE

This Samsung product is warranted for the period of twelve (12) months from the original date of purchase, against defective materials and workmanship. In the event that warranty service is required, you should return the product to the retailer from whom it was purchased. However, Samsung Authorised Dealers and Authorised Service Centres in other EC Countries will comply with the warranty on the terms issued to purchasers in the country concerned. In case of difficulty, details of our Authorised Service Centres are available from:

Samsung Electronics U.K. Ltd
Samsung Customer Support Centre
Selectapost 38, Sheffield, S97 3FJ
United Kingdom

United Kingdom
Tel : 0333 000 0333
www.samsung.com/uk/support

EIRE
Tel : 0818 717100
www.samsung.com/ie/support

■ WARRANTY CONDITIONS

1. The warranty is only valid if, when warranty service is required, the warranty card is fully and properly completed and is presented with the original invoice or sales slip or confirmation, and the serial number on the product has not been defaced.
2. Samsung's obligations are limited to the repair or, at its discretion, replacement of the product or the defective part. Repaired or replaced products may include new and or refurbished components and equipment.
3. Warranty repairs must be carried out by Authorised Samsung Dealers or Authorised Service Centres. No re-imburement will be made for repairs carried out by non Samsung Dealers and, any such repair work and damage to the products caused by such repair work will not be covered by this warranty.
4. This product is not considered to be defective in materials nor workmanship by reason that it requires adaptation in order to conform to national or local technical or safety standards in force in any Country other than the one for which the product was originally designed and manufactured. This warranty will not cover, and no re-imburement will be made for such adaptation nor any damage which may result.
5. This warranty covers none of the following:
 - a) Periodic check ups, maintenance and repair or replacement of parts due to normal wear and tear.
 - b) Cost relating to transport, removal or installation of the product.
 - c) Misuse, including the failure to use this product for its normal purposes or incorrect installation.
 - d) Damage caused by Lightning, Water, Fire, Acts of God, War, Public Disturbances, incorrect mains voltage, improper ventilation or any other cause beyond the control of Samsung.
6. This warranty is valid for any person who legally acquired possession of the product during the warranty period.
7. The consumers' statutory rights in any applicable national legislation whether against the retailer arising from the purchase contract or otherwise are not affected by this warranty. Unless there is national legislation to the contrary, the rights under this warranty are the consumers' sole rights and Samsung, its subsidiaries and distributors shall not be liable for indirect or consequential loss or any damage to disc based media, removable memory or any other related equipment or material.
8. Samsung shall honour warranties for all EU specification products purchased by a consumer within the following European countries listed.
 - UK, Republic of Ireland, Germany, France, Italy, Malta, Spain, Portugal, The Netherlands, Belgium, Luxembourg, Denmark, Sweden, Finland, Poland, Hungary, Czech Republic, Slovakia, Austria, Slovenia, Croatia, Estonia, Latvia, Lithuania, Greece, Cyprus, Romania, Bulgaria, Switzerland, Norway, Lichtenstein and Iceland.

SAMSUNG ELECTRONICS (U.K.) LTD.

SAMSUNG

© 2020 Samsung Electronics Co., Ltd. All rights reserved.

Contact SAMSUNG WORLD WIDE

If you have any questions or comments relating to Samsung products, please contact the SAMSUNG customer care Centre.

Country	Samsung Service Centre ☎	Web Site	Country	Samsung Service Centre ☎	Web Site
Europe					
UK	0333 000 0333	www.samsung.com/uk/support	CZECH	800 - SAMSUNG (800-726786)	www.samsung.com/cz/support
IRELAND (EIRE)	0818 717100	www.samsung.com/ie/support	SLOVAKIA	0800 - SAMSUNG (0800-726 786)	www.samsung.com/sk/support
GERMANY	06196 77 555 77	www.samsung.com/de/support	CROATIA	072 726 786	www.samsung.com/hr/support
FRANCE	01 48 63 00 00	www.samsung.com/fr/support	BOSNIA	055 233 999	www.samsung.com/support
ITALIA	800-SAMSUNG (800.7267864)	www.samsung.com/it/support	NORTH MACEDONIA	023 207 777	www.samsung.com/mk/support
SPAIN	91 175 00 15	www.samsung.com/es/support	MONTENEGRO	020 405 888	www.samsung.com/support
PORTUGAL	808 207 267	www.samsung.com/pt/support	SLOVENIA	080 697 267 (brezplačna številka)	www.samsung.com/si/support
LUXEMBURG	261 03 710	www.samsung.com/be_fr/support	SERBIA	011 321 6899	www.samsung.com/rs/support
NETHERLANDS	088 90 90 100	www.samsung.com/nl/support	KOSOVO	0800 10 10 1	www.samsung.com/support
BELGIUM	02-201-24-18	www.samsung.com/be/support (Dutch) www.samsung.com/be_fr/support (French)	ALBANIA	045 620 202	www.samsung.com/al/support
NORWAY	21629099	www.samsung.com/no/support	BULGARIA	0800 111 31 - Безплатен за всички оператори *3000 - Цена на един градски разговор или според тарифата на мобилният оператор 09:00 до 18:00 - Понеделник до Петък	www.samsung.com/bg/support
DENMARK	707 019 70	www.samsung.com/dk/support	ROMANIA	0800872678 - Apel gratuit *8000 - Apel tarifat în rețea	www.samsung.com/ro/support
FINLAND	030-6227 515	www.samsung.com/fi/support	CYPRUS	8009 4000 only from landline, toll free	www.samsung.com/gr/support
SWEDEN	0771 726 786	www.samsung.com/se/support	GREECE	80111-SAMSUNG (80111 726 7864) only from land line (+30) 210 6897691 from mobile and land line	
POLAND	801-172-678* lub +48 22 607-93-33* Specjalistyczna infolinia do obsługi zapytań dotyczących telefonów komórkowych: 801-672-678* * (opłata według taryfy operatora)	http://www.samsung.com/pl/support/	LITHUANIA	8-800-7777	www.samsung.com/lt/support
HUNGARY	0680SAMSUNG (0680-726-7864)	www.samsung.com/hu/support	LATVIA	8000-7267	www.samsung.com/lv/support
AUSTRIA	0800 72 67 864 (0800-SAMSUNG)	www.samsung.com/at/support	ESTONIA	800-7267	www.samsung.com/ee/support
SWITZERLAND	0800 726 786	www.samsung.com/ch/support (German) www.samsung.com/ch_fr/support (French)			