

# HCB-7000A

QHD (4MP) Analog Box Camera



## Key Features

- QHD (2560 x 1440, 30fps) resolution
- 0.16 Lux@F1.2 (Color), 0.009 Lux@F1.2 (B/W)
- Day & Night (ICR), DWDR, Motion detection
- Transmission distance Max. 500m
- Easy installation (Plug & play), Dual power

## Accessories (Optional)



SHB-4300H



SHB-4300H2



SHB-4300H1



SHB-4200



SHB-4200H

<b>Video</b>	
Imaging Device	1/3" 4MP CMOS
Effective Pixels	2688(H)x1520(V)
Min. Illumination	Color: 0.16Lux(F1.2, 1/30sec) BW: 0.009Lux(F1.2, 1/30sec)
Video Out	BNC(AHD), additional CVBS for installation
<b>Lens</b>	
Focus Control	Manual
Lens type	DC auto iris
Mount Type	C mount, CS mount
<b>Operational</b>	
Day & Night	Auto(ICR)
Backlight Compensation	UserBLC, HLC, DWDR
Digital Noise Reduction	2DDNR
Motion Detection	4 zones
Privacy Masking	2 zones
Gain Control	Low / Middle / High / Very High
White Balance	ATW / AWC / Manual / Indoor / Outdoor
Electronic Shutter Speed	1/30 ~ 1/12,000sec(N), 1/25~ 1/12,000sec(P)
Video Rotation	H-Rev/V-Rev
Analytics	Motion detection
Serial Interface	RS-485(Samsung-T, Pelco-D/P)
Alarm I/O	MD Output 1ea
Coaxial Protocol	ACP(AHD Coax Protocol), CVBS: Pelco-C(Coaxitron)
Video Transmission Distance	500m(5C2V Coaxial Cable)
<b>Network</b>	
Resolution	2560x1440
Max. Framerate	30fps@4M(N), 25fps@4M(P)
<b>Environmental</b>	
Operating Temperature / Humidity	-10°C ~ +55°C (+14°F ~ +131°F) / Less than 90% RH
<b>Electrical</b>	
Input Voltage	24VAC, 12VDC
Power Consumption	Max 3.6W
<b>Mechanical</b>	
Color / Material	Black / Aluminum, Ivory / Plastic
Product dimension / weight	59.6(W)×68.4(H)×92.7(D)mm (2.35"×2.69"×3.65"), 186g(0.41 lb)

- The latest product information / specification can be found at [hanwha-security.com](http://hanwha-security.com)
- Design and specifications are subject to change without notice.
- Wisenet is the proprietary brand of Hanwha Techwin, formerly known as Samsung Techwin.

NO	PART NAME	CODE NO.	MATERIAL	QTY	REMARK
----	-----------	----------	----------	-----	--------

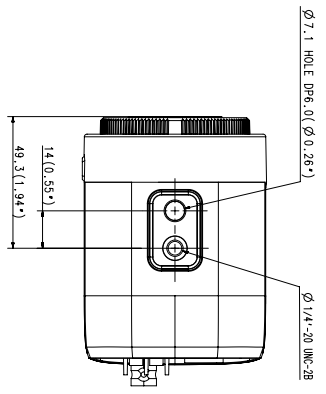
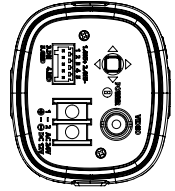
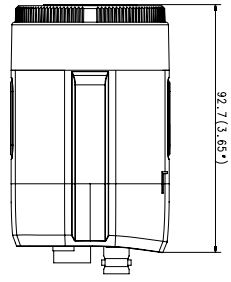
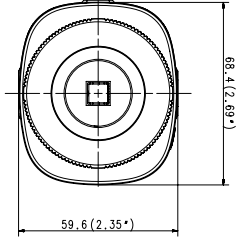
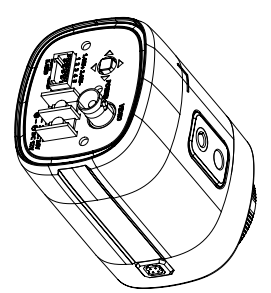
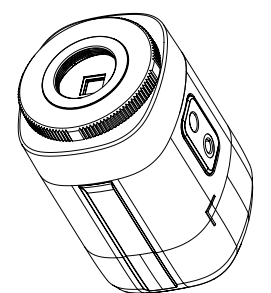
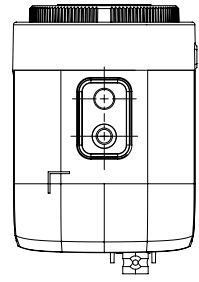

CHANGE

UNIT	MM	DESIGN	HTW	CHECK	APPROVAL	PART NAME	
SCALE	1/1					MODEL NAME	HCB-6000/7000
		HANWHA TECHWIN				CODE NO.	057887