



Overview

LifeSafety Power battery enclosures provide additional space for backup battery sets. Prebuilt enclosures are available in two different sizes with multiple shelf configurations for flexibility in battery options. Black powdercoat finish matches other LifeSafety Power equipment.

LifeSafety Power battery enclosures come standard with lockset and tamper-switch.

Part No.	Description	Size	Weight
E2-BS1	E2 Enclosure (1) shelf	20H x 16W x 4.5D encl	18 lbs.
E2-2BS1	E2 Enclosure (2) shelves	20H x 16W x 4.5D encl	19 lbs.
E4-2BS1	E4 Enclosure (2) shelves	24H x 20W x 6.5D encl	24 lbs.
E4-3BS1	E4 Enclosure (3) shelves	24H x 20W x 6.5D encl	25 lbs.
BS1	Single Battery Shelf	15.00" Wide X 4.00" Deep	0.50 lb.

Features

- Locking enclosures provide consistent look with other LifeSafety Power equipment
- 4" battery shelf accommodate multiple 4, 7, 8, 12, or 18 Ah batteries
- Multiple shelves can be used within an enclosure for additional battery capacity
- Enclosures can be configured for 12V, 24V, or simultaneous 12 & 24V use
- Pre-installed lock set and tamper switch

E2 Enclosure Battery Accomodation

E2-BS1 - One shelf

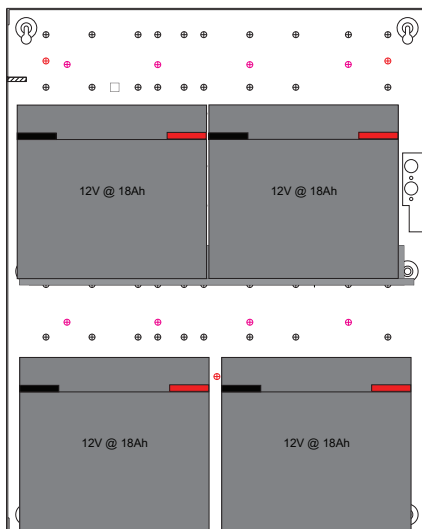

E2-2BS1 - Two shelves

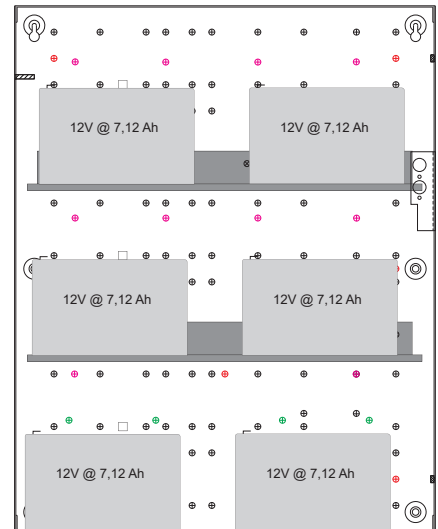
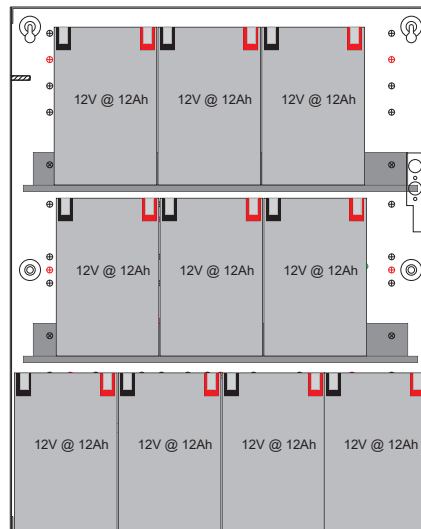

E4 Enclosure Battery Accomodation

E4-2BS1 - Two shelves

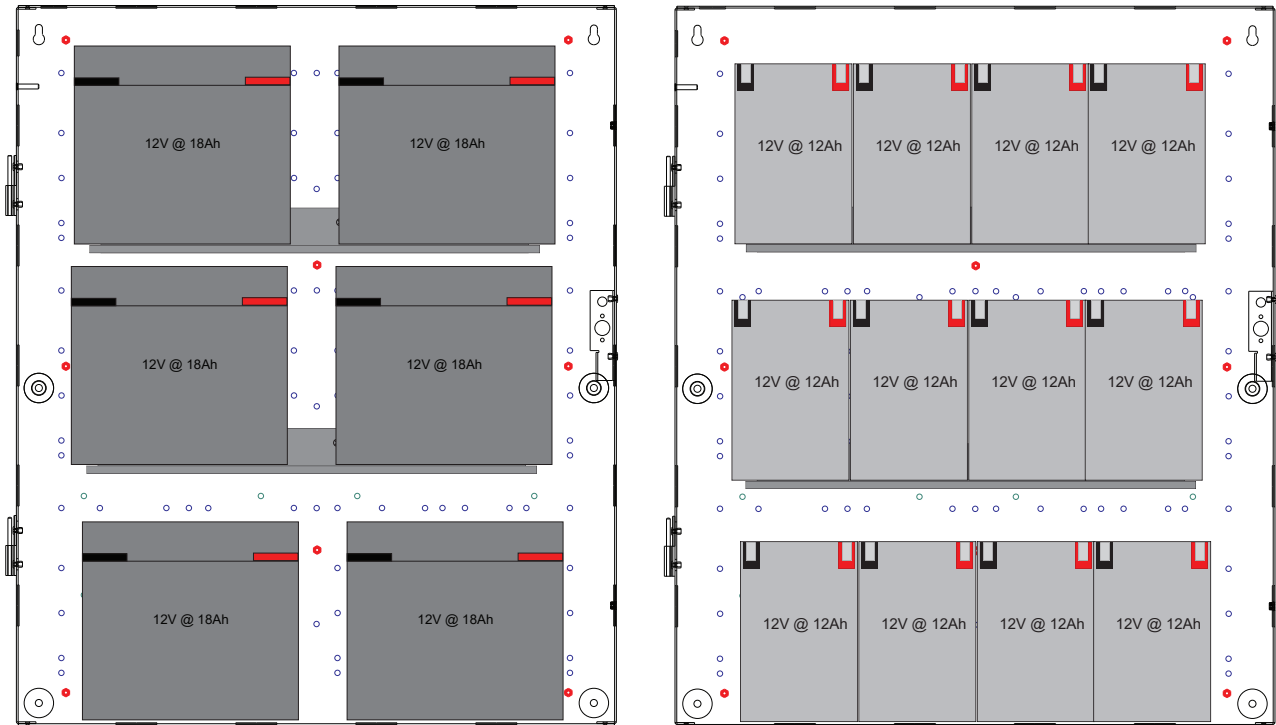

E4-3BS1 - Three shelves

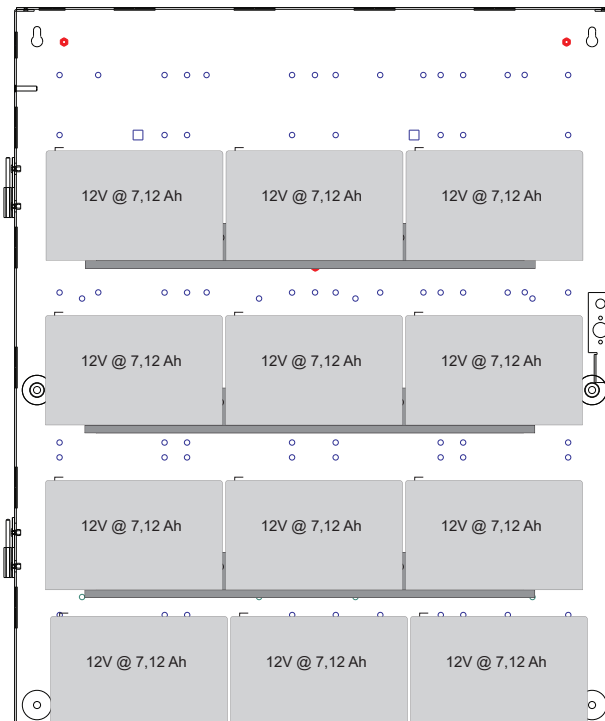

E2 Enclosure Dimensions (H x W x D) 20.00" x 16.00" x 4.50" (51 x 41 x 11.4 cm)

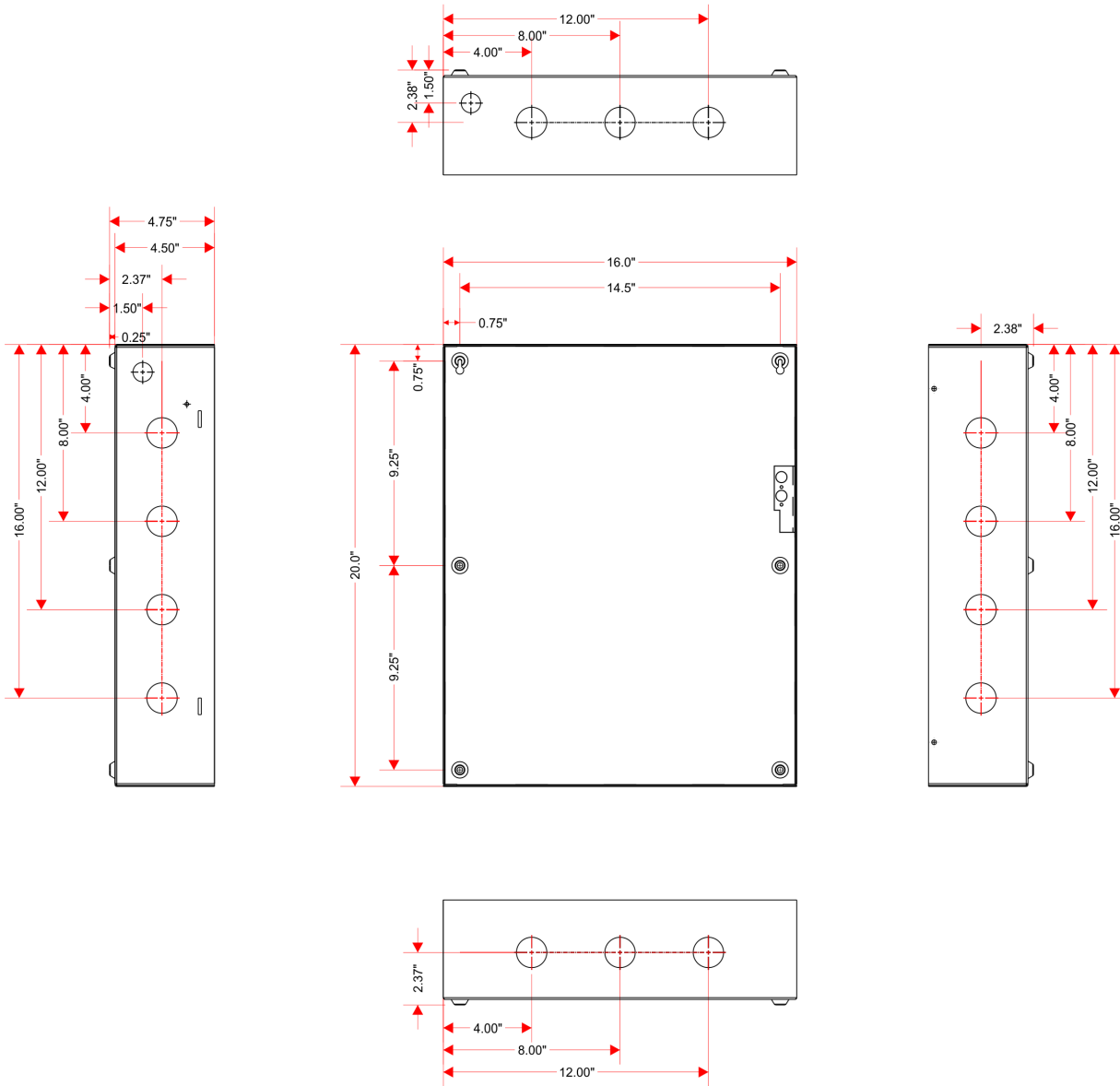

E4 Enclosure Dimensions (H x W x D) 24.00" x 20.00" x 6.50" (61 x 51 x 16.5 cm)

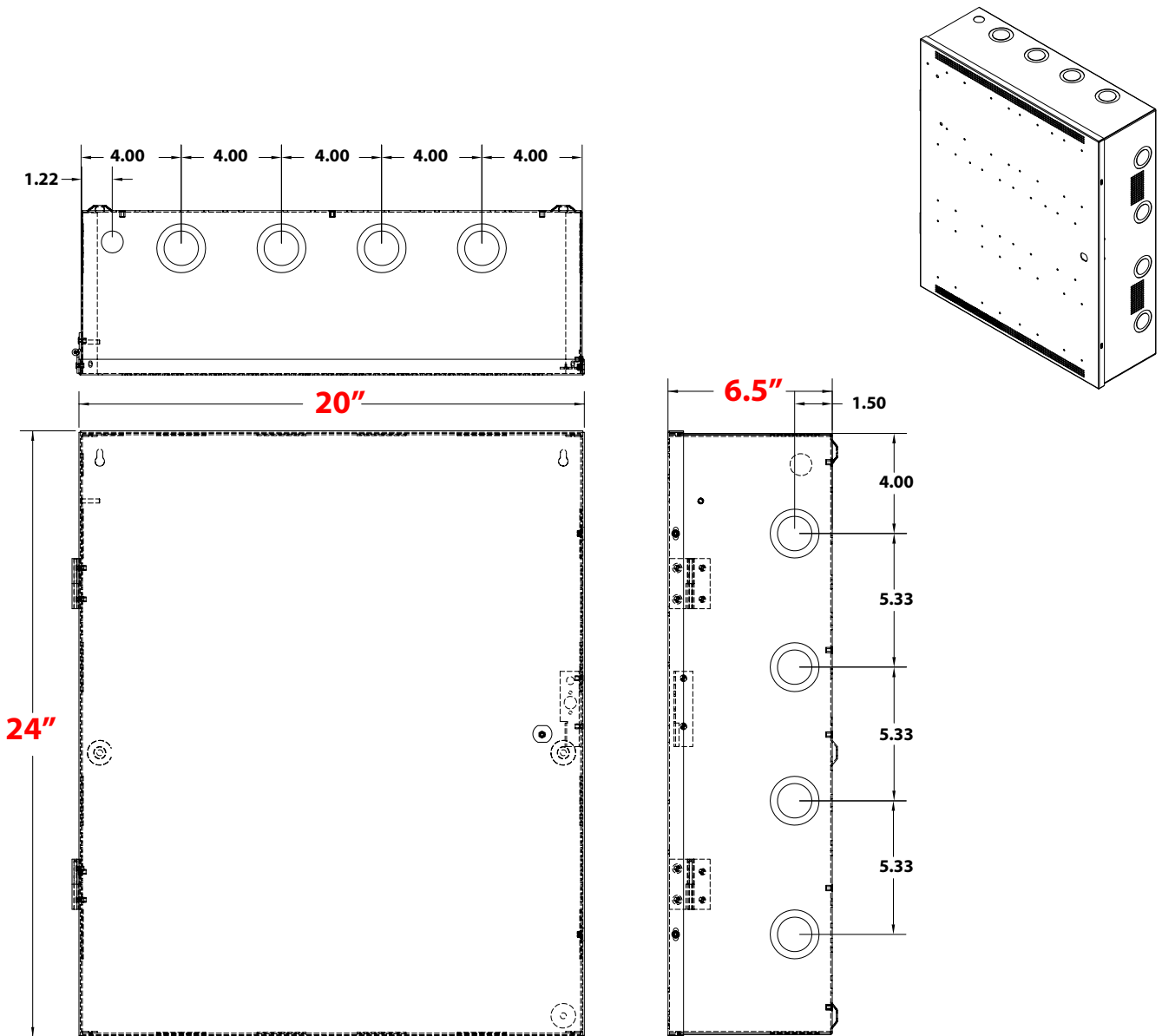

lifesafetypower.com

(888) 577-2898
info@lifesafetypower.com

Specifications subject to change without notice.

© 2020 LifeSafety Power Inc. All rights reserved. LifeSafety Power and FlexPower are registered trademarks of LifeSafety Power Inc. All other trademarks and copyrights are the property of their respective owners.

P01-924A 03/20

LifeSafety Power, Inc.
899 E Park Avenue
Libertyville, IL 60048 USA