

UniFLEX™ 55 Series Universal Application Strike

For New or Retrofit Construction. Retrofits Existing ANSI 4-7/8" Strike Prep
– No Centerline Relocation

UniFLEX™ 55 Series heavy duty electric strikes are designed for installation in hollow metal frames for access control of cylindrical and mortise locksets and mortise exit devices. The choice of 6 application faceplates eliminates the need for centerline relocation, making them ideal for new or retrofit , high security access control applications.



55-A

FEATURES

- No Centerline Relocation
- Up to ¾" Latchbolt and 1" Deadbolt
- Field Reversible, Failsafe/ Failsecure
- 1/8" Horizontal alignment adjustment
- ANSI/BHMA A156.31 Grade 1
- Factory tested 2500 lbs, exceeds 1,000,000 cycles
- UL tested 1500 lb Static strength
- 70 ft-lb Dynamic strength
- Internally Mounted Solenoid, No Heat in Keeper
- Dual Voltage 12/24VDC
- Tamper Resistant
- All Stainless Steel Corrosion Resistant Parts and Heavy Cast Body and Keeper
- Non-handed (Deadbolt status handed)
- Plug-in pig tail connectors
- UL1034 Listed, Burglary Resistant
- Warnoch Hersey tested according to UL10C, 3 Hr Fire Rated



55-B & 55-C

55-D & 55-E

55-F

REVERSIBLE FAILSAFE/FAILSECURE

Fail-Secure (Power-to-Unlock):
Unlocked when energized. Locked when de-energized and during power failure.

Application: For non fire rated and fire rated doors (exception, may not be used on stairwell doors). May not be maintained in the unlocked (energized) state when used with fire rated doors.

Fail-Safe (Power-to-Lock):
Locked when energized. Unlocked when de-energized and during power failure.

Application: Non-fire rated doors only.

CAUTION: Fail-safe is not permitted with the UL Fire Door Accessory label.

MODELS

55-ABC UniFLEX™ Universal Strike
(includes A, B and C faceplates and strike body)

55-A, 55-B, 55-C, 55-D, 55-E, 55-F

UniFLEX™ Spec with specific faceplate includes strike body (see page page 73 for application)

UniFLEX™ Universal Strike 55-ABC

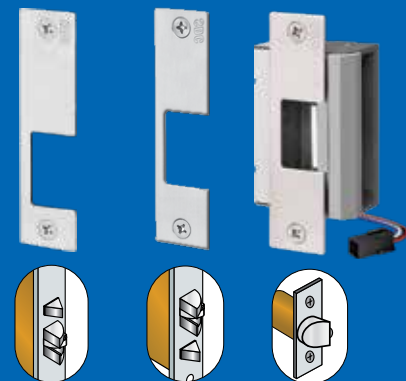

55-ABC Universal Strike for cylindrical locks, mortise locks without deadbolts and mortise exit devices, including:

SDC	Corbin	Marks
Accurate	Ruswin	Sargent
Arrow	Dorma	Schlage
Baldwin	Falcon	Yale
Best	Hager	



SPECIFICATIONS

Electrical

Dual Voltage Power Input 600/300 @ 12/24V DC

Monitoring Contacts SPDT, Dry, 5Amp @ 30V



Warnock Hersey Tested according to:
UL 10C, 3 Hr Fire Rated, 4' x 8' single door NFPA-252



CAN4-S104 (ULC-S104) (Fail-Secure only).
UL 1034 BP10254
Burglary-Resistant 40WH

PRODUCT SKU SAMPLE: 55-D U DBM-L

HOW TO ORDER

1 | SPECIFY MODEL

- 55-A** Compatible locks with all cylindrical locksets with up to 5/8" latch.
- 55-B** Mortise locksets and exit mortise devices with or without a deadlatch located below the latch-bolt.
Accurate, Arrow, Best, Corbin Russwin, Dorma, Falcon, Marks, Sargent, Yale, PDQ.
- 55-C** Mortise locksets and mortise exit devices with or without a deadlatch located above the latch-bolt.
SDC, Schlage, Baldwin, Hager
- 55-D** Mortise locksets with a deadbolt. Deadlatch located **below** the latchbolt.
Accurate, Arrow, Best, Corbin Russwin, Dorma, Falcon, Marks, Sargent, Yale, PDQ.
- 55-E** Mortise lockset with deadbolt and **no dead-latch** feature. Baldwin
- 55-F** Mortise locksets with a deadbolt and a dead-latch located **above** the latchbolt.
SDC, Schlage, Hager.

2 | SPECIFY FINISH

- U** 630 Stainless Steel (std)
- D** 606 Dull Brass
- G** 612 Dull Bronze
- H** 613 Oil Rubbed Bronze
- P** 625 Bright Chrome
- Q** 626 Dull Chrome

3 | SPECIFY MONITORING OPTIONS

- LBM** Latchbolt Monitor. Signals the door is closed and latched or unlatched and open. Non-handed.
- LBM/ LCM** Door Secure Monitor. Signals door is closed latched and the keeper is deadlocked. Also signals the door is unlatched or unlocked. Non-handed.

3 | SPECIFY DEADBOLT MONITORING (AVAILABLE ONLY FOR 55-D, 55-E, 55-F)

- DBM-L** Deadbolt Monitor, Left Hand
- DBM-R** Deadbolt Monitor, Right Hand

ACCESSORIES

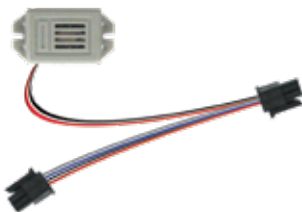

50-RMB
Plug-In Buzzer, 12/24V
Indicates failsecure strike is energized and unlocked



BR64XL
Rectifier with Wire Leads
Converts AC to DC



CA-55-4
Replacement (1) 12 V and (1) 24V pigtail connector, 4" leads
(1 set included with all 55 strikes)

UNIFLEX™ SPEC - APPLICATION SPECIFIC FACEPLATES INCLUDED

Lock Compatibility: To determine compatibility of locksets not listed below, see faceplate dimensions.

Uniflex Spec models include strike and faceplate for individual job requirements.

Recommend for specifiers and industry professionals for fast and easy specification of individual installation requirements.

MODEL	FACEPLATE DIMENSION	LOCKSET	APPLICATION	COMPATIBLE LOCKS	OPERATION
55-A			<ul style="list-style-type: none"> •Cylindrical locksets •Locksets with ANSI centerline latch entry lockset with up to 3/4" latchbolt 	<ul style="list-style-type: none"> •All cylindrical locksets with 1/2" to 5/8" latchbolts •SDC •Locksets with ANSI centerline latch entry with up to 3/4" latchbolt 	After releasing the latchbolt, the keeper returns to the locked position.
55-B			<ul style="list-style-type: none"> •Mortise locksets and mortise exit devices with or without a deadlatch located <u>below</u> the latchbolt. 	<ul style="list-style-type: none"> • Accurate • Arrow • Best • Corbin Russwin • Dorma • Falcon • Marks • Sargent • Yale • PDQ 	After releasing the latchbolt, the keeper returns to the locked position.
55-C			<ul style="list-style-type: none"> •Mortise locksets and mortise exit devices with or without a deadlatch located <u>above</u> the latchbolt. 	<ul style="list-style-type: none"> •Schlage •SDC •Baldwin •Hager 	After releasing the latchbolt, the keeper returns to the locked position.
55-D			<ul style="list-style-type: none"> •Mortise locksets with a deadbolt. Deadlatch located <u>below</u> the latchbolt. •With deadbolt retainer installed, access control will not release projected deadbolt. •With deadbolt retainer removed, access control will release deadbolt. The door will not close when deadbolt is projected. 	<ul style="list-style-type: none"> • Accurate • Arrow • Best • Corbin Russwin • Dorma • Falcon • Marks • Sargent • Yale • PDQ 	<p>Deadbolt Retracted: When signaled by the access control the strike keeper unlocks, permitting door latch release. The strike keeper returns to the closed and locked position. The door then returns to the closed and locked position.</p> <p>Deadbolt Retainer Installed</p>
55-E			<ul style="list-style-type: none"> •Mortise lockset with a deadbolt. •With deadbolt retainer installed, access control will not release projected deadbolt. •With deadbolt retainer removed, access control will release deadbolt. The door will not close when deadbolt is projected. 	<ul style="list-style-type: none"> •Baldwin 	<p><u>Night-Latch/Access Control Lockout:</u> When the deadbolt is projected the strike will not release by access control.</p> <p>Deadbolt Retainer Removed</p> <p><u>Night-Latch:</u> When the deadbolt is projected, the strike keeper unlocks, permitting door latch and deadbolt release by the access control. The strike keeper returns to the closed and locked position. The door will not close and lock when the deadbolt is extended and must be manually retracted to permit door closure.</p>
55-F			<ul style="list-style-type: none"> •Mortise locksets with a deadbolt and a deadlatch located <u>above</u> the latchbolt. •With deadbolt retainer installed, access control will not release projected deadbolt. •With deadbolt retainer removed, access control will release deadbolt. The door will not close when deadbolt is projected. 	<ul style="list-style-type: none"> •Schlage •SDC •Hager 	<p><u>Night-Latch:</u> When the deadbolt is projected, the strike keeper unlocks, permitting door latch and deadbolt release by the access control. The strike keeper returns to the closed and locked position. The door will not close and lock when the deadbolt is extended and must be manually retracted to permit door closure.</p>

FIG. 1 WIRE DIAGRAM
55 SERIES ELECTRIC STRIKE



HIGH SECURITY DOOR SECURE MONITORING:
LBM/LCM Required
LCM & LBM wired in series indicates door is closed, latched and deadlocked or door is unlatched, open or unlocked.

FIG. 2 FIELD REVERSIBLE
FAILSAFE / FAILSECURE

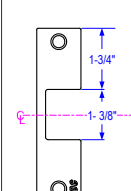
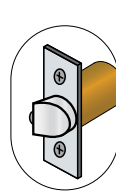
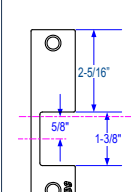
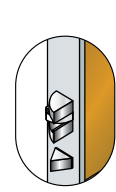
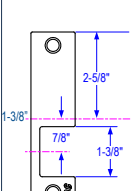
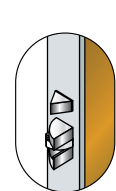
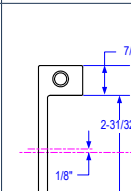
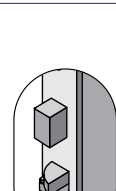
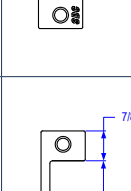
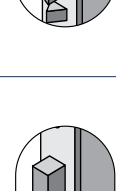
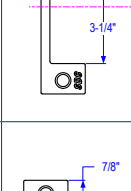
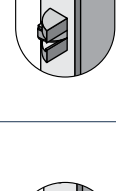
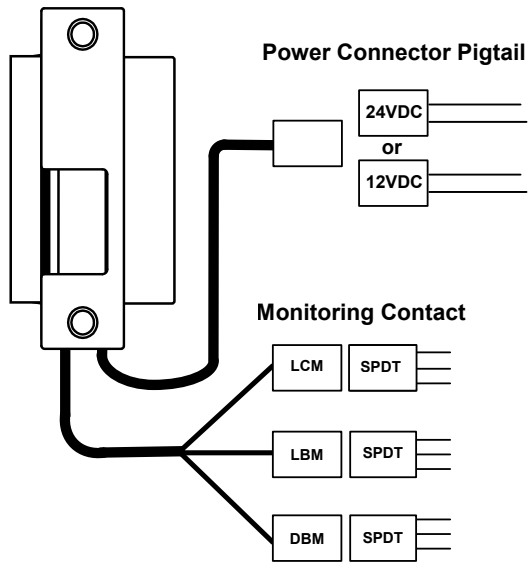
Failsecure Mode: Factory supplied, Failsecure
Failsafe Mode: Remove cover, push solenoid toward end of strike as shown below.

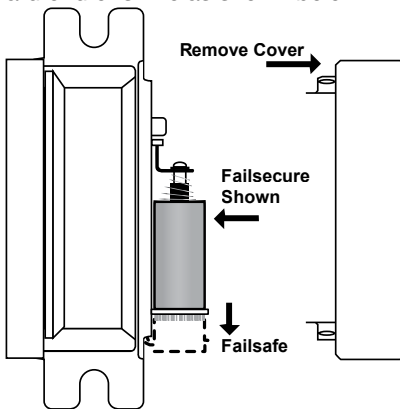

FIG. 3 QUICK CONNECT POWER INPUT
(INCLUDED WITH STRIKES)

- 12VDC and 24VDC pigtails Included
- No need to cut and splice wires to configure voltage
- Fewer wire nuts required
- Small connectors provide organized space saving wiring
- Easy troubleshooting

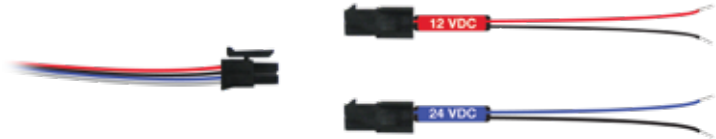

FIG. 4 QUICK CONNECT BUZZER (SEE ACCESSORIES)

- Buzzer in line between small connectors
- For failsecure strikes, audible tone indicate unlocked
- No need to cut and splice wires
- Reduces wire nut connections
- Small connectors provide organized space saving wiring
- Easy troubleshooting

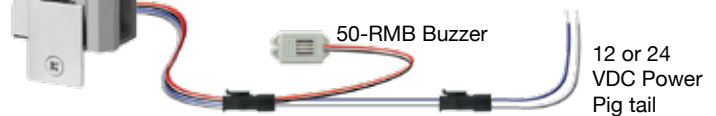

FIG. 5 HORIZONTAL ALIGNMENT ADJUSTMENT

3A-Nominal Alignment: Loosen mounting screws. Shift strike body behind the faceplate horizontally. Tighten mounting screws.
3B-Excessive Alignment Issues: Remove shim filler bar from keeper.

