



TREND NETWORKS



LanTEK IV

The Future of
Cable Certification

Depend On Us



LanTEK® IV

TREND Networks

100 First bank

Tests Default Customer Name

Last Test

All Tests (00)

A-021

Class C PL3

A-022

Class C PL3

A-023

Class C PL3

A-024

Class C PL3

Autotest

Home

Back

Power

LanTEK IV

Cable Certifier

The Future of Cable Certification



The LanTEK IV is a new Cable Certification System that brings a new standard to the industry, making the job faster, easier and more profitable.

LanTEK IV - Copper and Fiber Certifier

7 Second Test Time - Test and save a Cat6A test within 7 seconds.

VisiLINQ™ increases productivity - VisiLINQ™ permanent link adapters present a new and unique way to test, everything you need to operate the certifier and verify the results in the palm of your hand.

Future proof - Certify links to Cat8.1 and Cat8.2 including TCL and resistance unbalance measurements. The LanTEK IV will test up to 3000MHz providing room for future ratified ISO/TIA test standards.

No downtime or unexpected bills - The Sapphire Care Plan is designed to minimize down time, reduce the cost of ownership and protect against unforeseen repair bills.

Label printer connectivity saves time - Easily create complex naming conventions that are seamlessly transferred to a label printer for fast and accurate labeling.



TREND AnyWARE Cloud - Test Management Software

(Desktop version also available)

Eliminate costly setup errors - Project Managers pre-configure all project information in the TREND AnyWARE Cloud and Field Technicians simply download the project to the LanTEK IV eliminating any mistakes from manual data entry.

Live support - Colleagues, Cable Manufacturers and TREND Networks Technical Support can connect to the LanTEK IV remotely, minimizing troubleshooting time, increasing collaboration and reducing call-backs.

Reduce equipment costs with Test4Less

The **Test4Less** offering allows companies requiring three or more certifiers to pay per-test rather than paying full price up front.





VisiLinq™



Work smarter not harder with the unique VisiLINQ™ Permanent Link Adapter

VisiLINQ™ enables Field Technicians to initiate testing and view the results all without the need to carry or touch the certifier.

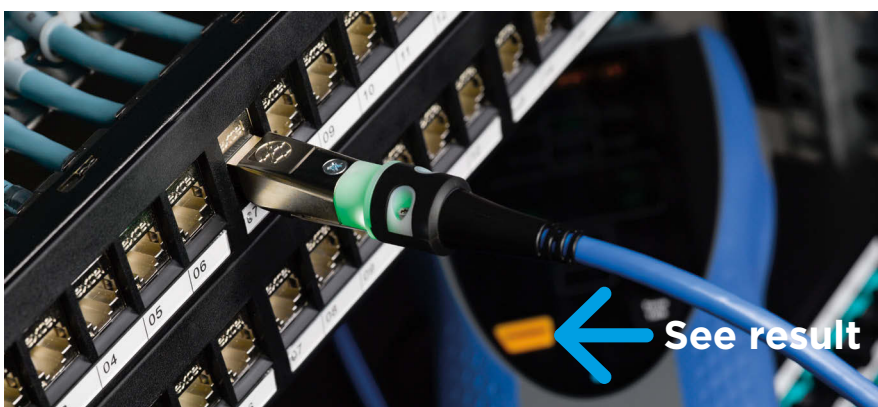
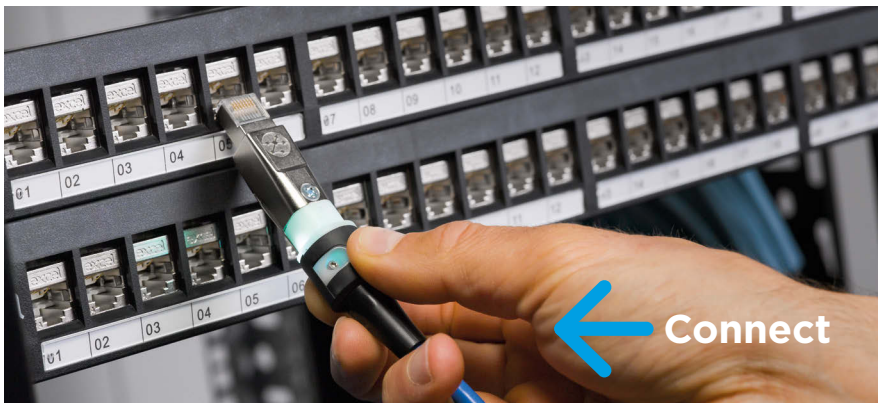

The RJ45 tip on the VisiLINQ™ Permanent Link Modules are field replaceable to reduce the cost of ownership, independently verified for 2,000 insertions which is 1,250 more than regular patch cord plugs rated to ISO/TIA standards.

Everything you need to operate the certifier and verify the results in the palm of your hand.

Test Management Software



The new TREND AnyWARE Cloud management system allows real time collaboration between Project Managers and Field Technicians. There is no need for Field Technicians to setup the LanTEK IV, Project Managers pre-configure the jobs and tests in the TREND AnyWARE Cloud, eliminating potential mistakes and compressing the time taken to prepare reports for customers and warranties.



Cloud software

- **Operates anywhere with a web browser** – TREND AnyWARE Cloud operates on a PC, Mac and tablet devices (Android and iOS)
- **Free storage** – No need for separate servers or backup systems.
- **Easy to find project files** – Attach all project files including cable layout drawings, videos, and photos into the TREND AnyWARE Cloud. Everything you need in one place.
- **Share reports easier** – Use TREND AnyWARE Cloud to share links to the test reports eliminating the need to manually email large attachments.
- **Reduce training time with WalkMe** – TREND AnyWARE Cloud is embedded with the WalkMe digital adoption platform providing proactive, step-by-step guidance on all key tasks.

Fleet management

- **Easily manage the certifier fleet** – Fleet manager allows you to see who has the certifier, when the software was last updated, calibration due date and when the results were last synced. Allowing you to manage tester downtime and ensuring results are transferred back to the office and not lost or deleted.

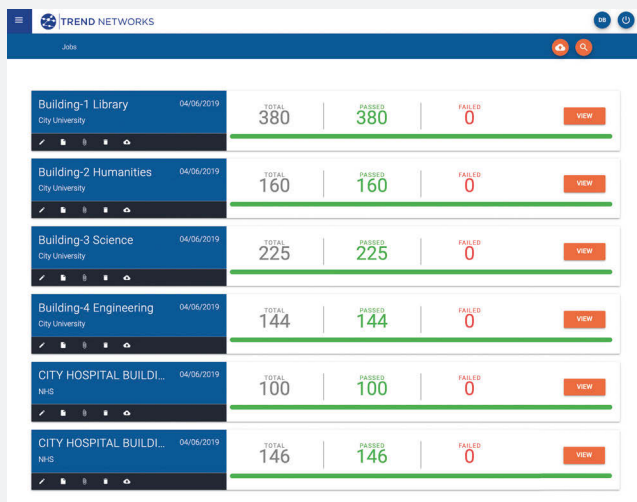

TREND AnyWARE Cloud Jobs screen



TREND AnyWARE Cloud Test Result screen

Real time collaboration between Project Managers and Field Technicians

Pre-configuration

- **Reduce setup errors** – Project Managers pre-configure all project information in the TREND AnyWARE Cloud and Field Technicians simply download the project to the LanTEK IV eliminating any mistakes from manual data entry.
- **Create the most complex test ids** – Easily create simple or sophisticated naming conventions required by the client.

Troubleshooting

- **Advanced filtering** – filter tests on any field to reduce the time spent searching.

Support

- **Reduce training time** – The TREND AnyWARE Cloud comes with proactive, step-by-step guidance for all the key features.
- **Team Viewer Live Support** – Using the TREND AnyWARE Cloud users can connect to a LanTEK IV remotely to troubleshoot failed links, minimising troubleshooting time, increasing collaboration and reducing call-backs.

Professional reports

- **Customer profiles** – Create a profile for each of the customers with their company logo, address and contact details. This information is automatically pulled through to the reports, saving time.
- **2 Report Formats**
 - **Single line report** – This is a summary report showing multiple tests per page.
 - **Brief report** – This is a comprehensive report with all the measurement results with one page per test.

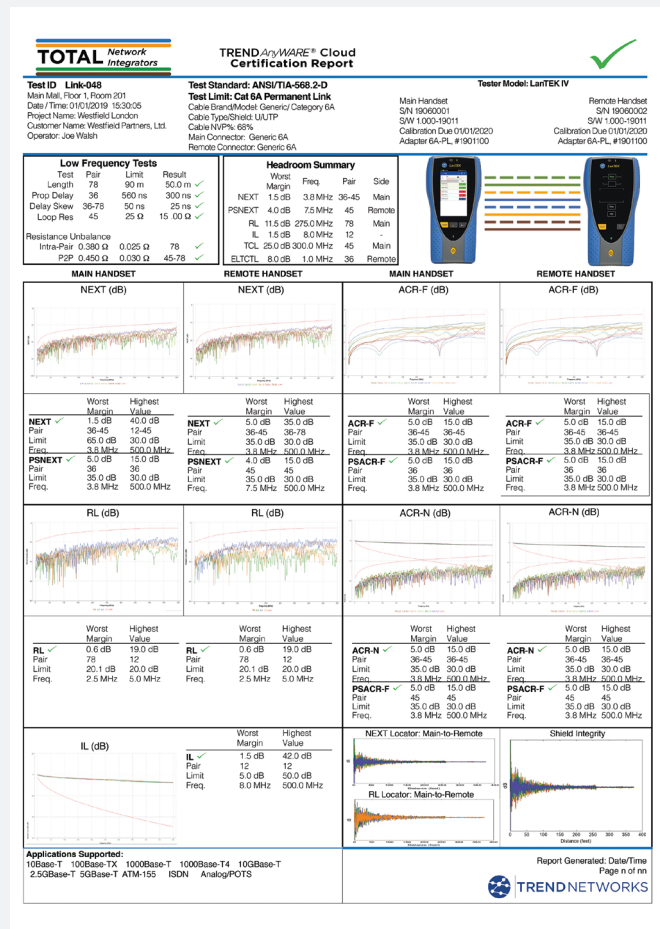

Professional PDF Report generated by the TREND AnyWARE Cloud

LanTEK IV



Voltage Protection

Provides immediate notification/protection if accidentally connected to PoE

Partner Finder

Provides audible tone and visible indicator when connected to the remote unit

Complete Connectivity

Wi-Fi
Bluetooth
USB A
USB C

Intuitive User Interface

Simplified user interface for easy setup and operation

Live wiremap

Instant wiremap result before the Autotest begins

Touchscreen

High resolution impact resistant touchscreen for ease of use

Label Printer Connectivity

Easily send label IDs to printers for fast and accurate labeling

Beyond Cat 8 / Class II

LanTEK IV 3000 MHz exceeds highest current standards by 50% for future applications

Integrated Kickstand

Integrated Kickstand Allows for convenient placement on a desk or shelf for easy viewing

Performs all extended measurements

TCL / ELTCTL
Common / Differential NEXT
Resistance Unbalance
Shield integrity

Rugged Design

Rubberized housing, protected screen and protected measurement port (Patented)



Permanent Link Modules (VisiLINQ™)

To test and certify UTP/STP Cat5e/6/6A/8.1 cabling from the patch panel to the work area outlet. The RJ45 tip on the Permanent Link Modules are field replaceable to reduce the cost of ownership.



Channel Modules

Select from a wide wide range of Channel Testing Modules for various applications including: Cat6A RJ45, Cat8.1 RJ45, Cat7A/8.2 GG45, TERA and EC7.



Patch Cord Modules

Cat5e/6/6A testing modules are available for certification of patch cords to TIA and ISO standards. A patch cord module can be combined with a permanent link adapter to perform a Modular Plug Terminated Link (MPTL) test.

FiberTEK IV

Troubleshooting

Red laser light source to visually pinpoint faults and locate fiber ports

Receive LED indicator

Flashes red to warn of light from other sources, green when linked to FiberTEK IV

Supports all common connector types

SC, FC, ST adapters included. LC adapters optional

Certification

Tier-1 certification of single-mode and multimode fiber optic cabling

Simplified bi-directional measurements

Eliminates process of manually merging directional tests into one record

Encircled Flux compliance

Enables compliance to the new 2016 fiber standards IEC 14763-3 and ANSI/TIA- 526-14-C (optional accessory - see back page for details)

Field calibration

Allows 1 and 3 jumper field calibration methods to ensure accuracy and compliance to ISO/IEC and ANSI/TIA standards

Complies with all international standards including ANSI/TIA, ISO/IEC

See website for full details

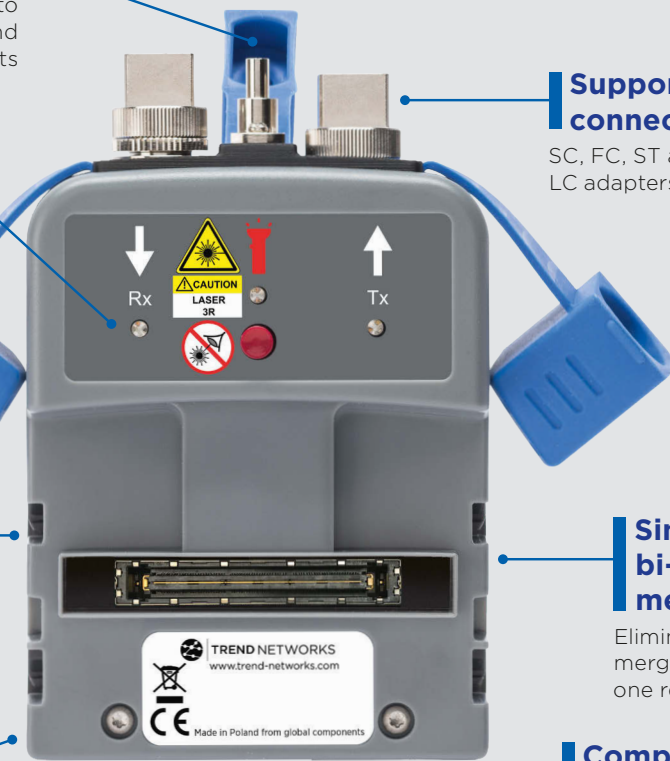

Applications

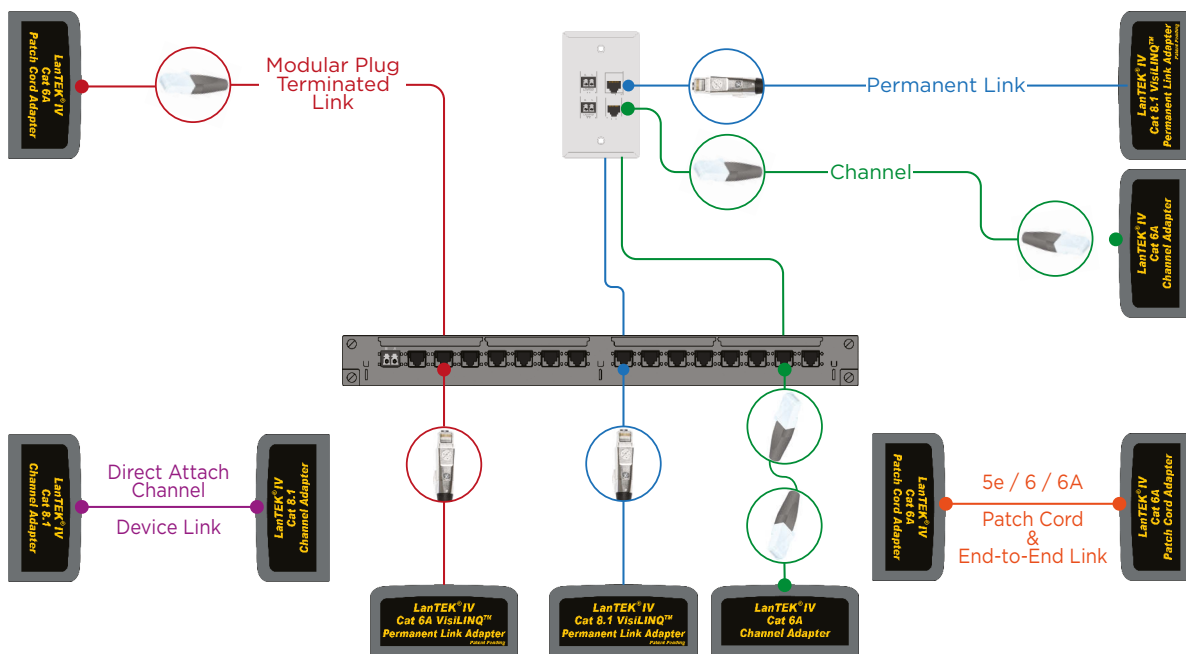



Sapphire CARE PLAN

Complete protection for your LanTEK IV and FiberTEK IV

The Sapphire Care Plan is designed to help minimize down time, reduce the cost of ownership and protect against unforeseen repair bills.

Free Annual Calibration – Maintain Accuracy

Free Repairs – Protect Against Unforeseen Bills

Free Loan Unit During Repairs and Calibration – No Downtime

Free Online Training and Technical Support – Improve Efficiency

Free Shipping – Reduce Costs

Free Replaceable Wear Parts – Reduce Cost of Ownership

Every year choose from one of the following options.

- 4 x Permanent Link Adapter Tips (Pair)
- 4 x CAT6A Reference Patch Cord (Single)
- 2 x CAT6A Channel Adapter (Single)
- 1 x LanTEK III/IV Battery (Single)



Team Viewer Live Support

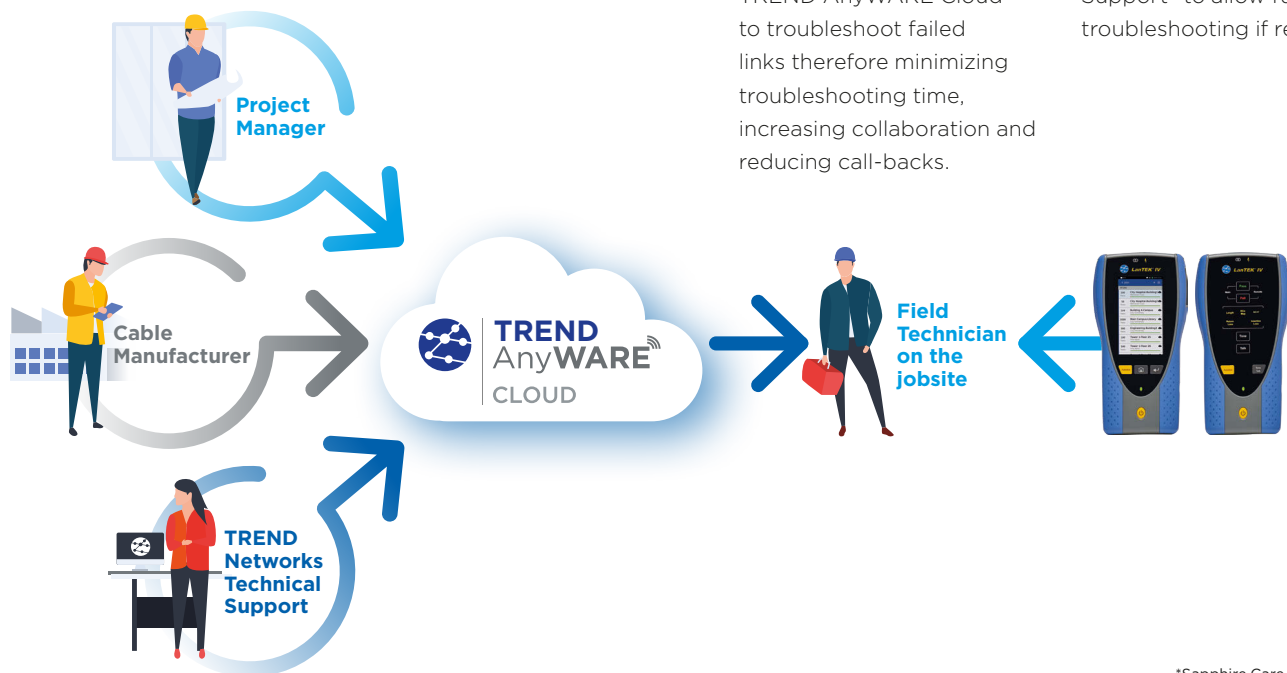

Project Managers can connect to a LanTEK IV on the jobsite using the TREND AnyWARE Cloud to troubleshoot failed links therefore minimizing troubleshooting time, increasing collaboration and reducing call-backs.

Access can be granted to cable manufacturers and TREND Networks Technical Support* to allow further troubleshooting if required.

*Sapphire Care Plan Required

Unique “Pay As You Test” (PAYT) options improves cash flow

If three or more certifiers are required our ‘Pay As You Test’ options can turn your certifier fleet from what is traditionally a capital cost into an operating expense, optimizing cash flow and allowing you to spread the cost over time. This offers the flexibility to make purchases within your budget and makes it easier to assign costs to projects. Simple payment options start from no money upfront to as little as £2,750 per certifier.

Purchase test credits as and when you need to with these easy steps.

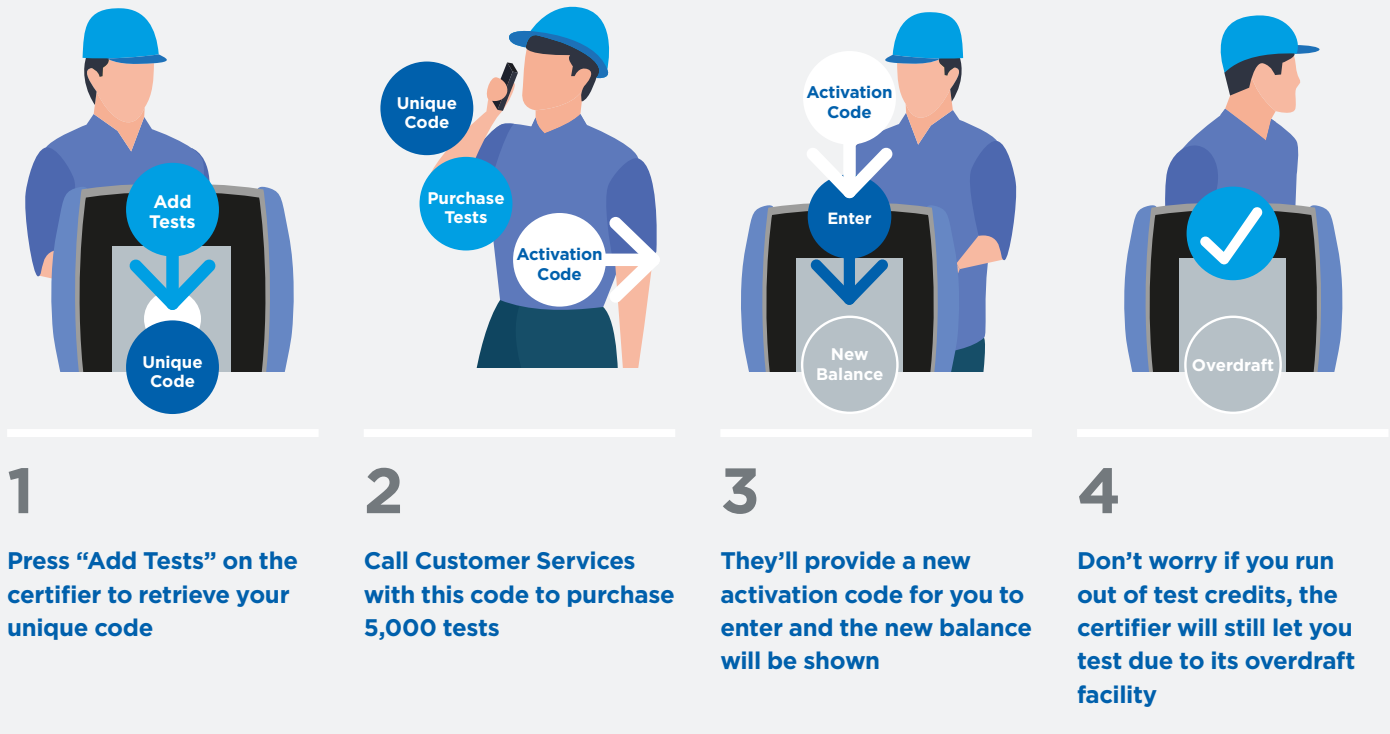

LanTEK IV

Cable Certifier



Ordering information

Part No	Kit Contents
R163000	LanTEK IV-500MHz Cable Certifier. TIA Category 6A/ ISO Class EA. LanTEK IV Display/Remote handsets, Li-ion Battery (2), Univ. Power Adapter (2), Hang Strap (2), Quick Ref. Guide, Carry Case, CAT6A RJ45 VisiLINQ Permanent Link Adapters (2)
R163001	LanTEK IV-3000MHz Cable Certifier. TIA Category 8/ ISO Class I/II. LanTEK IV Display/Remote handsets, Li-ion Battery (2), Univ. Power Adapter (2), Hang Strap (2), Quick Ref. Guide, Carry Case, CAT8 RJ45 VisiLINQ Permanent Link Adapters (2)
TRADE163000	Trade-In of any Cat5e (or higher) cable certifier to a LanTEK IV 500MHz
TRADE163001	Trade-In of any Cat5e (or higher) cable certifier to a LanTEK IV 3000MHz

Ordering information

Part No	Kit Contents
R164008	FiberTEK IV-MM LED Kit. Two multimode FiberTEK IV modules, lockable semi-rigid carrying case, SC, FC, ST adapters for modules (2 ea.), SC-SC patch cords, 6x 50µm MMF) compliant to ISO/IEC 14763-3 standard, quick reference guide. Compatible with LanTEK IV.
R164009	FiberTEK IV-SM Laser Kit. Two single-mode FiberTEK IV modules, lockable semi-rigid carrying case, SC, FC, ST adapters for modules (2 ea.), SC-SC patch cords, 6x 9µm MMF) compliant to ISO/IEC 14763-3 standard, quick reference guide. Compatible with LanTEK IV.
R164010	FiberTEK IV-MM LED & SM Laser Kit. Two multimode FiberTEK IV modules, two single-mode FiberTEK IV modules, lockable semi-rigid carrying case, SC, FC, ST adapters for modules (2 ea.), SC-SC patch cords, 6 x 9µm, 6 x 50µm compliant to ISO/IEC 14763-3 standard, quick reference guide. Compatible with LanTEK IV.

LanTEK IV Optional Adapters and Accessories

Part No	Descriptions
R163052	LT IV-CAT6A/6/5e RJ45 Channel Adapter (Single)
R163053	LT IV-Cat8.1/6A/6/5e RJ45 Channel Adapter (Single)
R163054	LT IV-Cat8.2 TERA Universal Adapter (Single)
R163056	LT IV-Cat8.2 GG45 Universal Adapter (Single)
R163055	LT IV-Cat8.2 EC7 Universal Adapter (Single)
R163057	LT IV-Cat5e / Class D Patch Cord / MPTL Test Adapter (Single)
R163058	LT IV-Cat6 / Class E Patch Cord / MPTL Test Adapter (Single)
R163059	LT IV-Cat6A / Class Ea Patch Cord / MPTL Test Adapter (Single)
R161050	LT III/IV-CAT6A/8.1 PLA Replacement Tips (Pair)

FiberTEK IV Optional Accessories

Part No	Descriptions
R164050	FT III/IV-Encircled Flux 50/125um Cable SC - SC
R164051	FT III/IV-Encircled Flux 50/125um Cable SC - LC
R164064	FTIII/IV - LC Receiver Adapter (Single)

LanTEK III 500MHz cable certifier is also available to purchase. See website for details.

All LanTEK IV cable certifiers include permanent link adapters as standard to minimize unnecessary costs. Channel adapters maybe purchased separately if required.

Sapphire Care Plans for LanTEK III/IV and FiberTEK III/IV

Part No	Descriptions
SCP1YRN	Sapphire Care Plan - Copper - 1 Year (incl. 10% discount) *
SCP2YRN	Sapphire Care Plan - Copper - 2 Years (incl. 10% discount) *
SCP3YRN	Sapphire Care Plan - Copper - 3 Years (incl. 10% discount) *
SCP1YR	Sapphire Care Plan - Copper - 1 Year
SCP2YR	Sapphire Care Plan - Copper - 2 Years
SCP3YR	Sapphire Care Plan - Copper - 3 Years
SCP1YF	Sapphire Care Plan - Fiber (Per Pair) - 1 Year
SCP2YF	Sapphire Care Plan - Fiber (Per Pair) - 2 Years
SCP3YF	Sapphire Care Plan - Fiber (Per Pair) - 3 Years

Included: Free repairs, free annual calibration, free loan tester during repairs and calibration, free shipping, free firmware updates, free technical support, free replaceable wear parts. Terms and conditions apply.

* When purchased within 60 days of purchasing a new LanTEK III/IV.



TREND NETWORKS, LanTEK, FiberTEK, VisiLINQ and the TREND AnyWARE logos are trademarks or registered trademarks of TREND NETWORKS.



Specification subject to change without notice. E&OE
© TREND NETWORKS 2020
Publication no.: 163804, Rev. 3.