

WBL Indoor/Outdoor Wall Mounting Bracket



	WBL
Color	Hikvision white
Feature	Suitable for box or bullet camera and housings indoor/outdoor wall mounting
Material	Aluminum alloy
Angle	Horizontal: 360°; Vertical: -45° to 45°
Dimension	83 mm × 123.9 mm × 304 mm
Weight	765 g

Features

- Die Cast Aluminum with Surface Spray Treatment
- Cable Entry
- Rubber Cushion Ensures Camera Stabilization
- Pan Tilt Adjustment

Dimensions

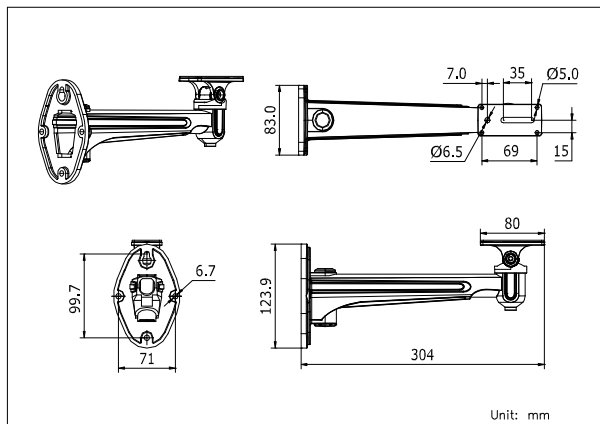

- NOTES:** Pay attention to the color matching.
Install mount on flat surface of wall.
Hole site diameter is within 6.5 mm.
Distance between the two screw holes is 2 mm to 54 mm.
Wall must be capable of supporting more than three times the total load of the camera and the mount.
Maximum capacity load of bracket arm is 8.5 kg
Maximum load capacity of the mount is 2.5 kg.

Order Model

WBL

Installation

1. Choose the appropriate wall to mount the bracket.

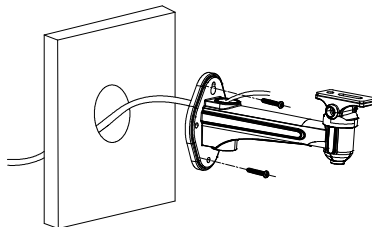

2. Complete the bracket installation and wiring.

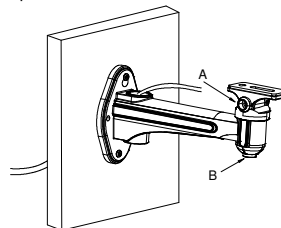

A: Vertical adjustment screw
B: Horizontal adjustment screw

3. Unscrew the vertical adjustment screw and remove the baseplate from the bracket.

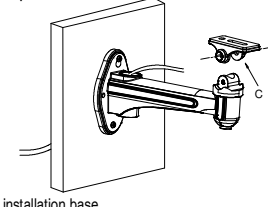

C: Camera installation base

4. Fix the camera onto the baseplate.

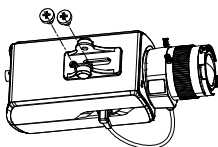

5. Fix the camera and baseplate onto the bracket; adjust the view and angle.

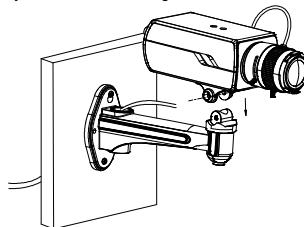

6. The bracket can also be used with housings.

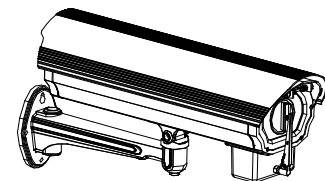

NOTE: The actual bracket may vary from the picture above.