

# Indoor/Outdoor 30x Zoom WDR PTZ IP Cameras

HDZ302DE / HDZ302D / HDZ302DIN-C1 / HDZ302DIN-S1

Honeywell's latest HDZ PTZ is part of the growing line of IP-based products. The high definition, True Day/Night WDR PTZ cameras provide extremely crisp video with up to 2 million effective pixels and 30x optical zoom for continuous surveillance in both outdoor and indoor applications.

## Superior Image Quality

- Full HD 1080p resolution, 50/60 fps image with a 1/2.8" 2 megapixel sensor
- True WDR 120 dB ensures glare-free images
- True Day/Night provides vivid colour images by day and clear black-and-white images at night with ICR (Infrared Cut Filter Removal)
- Excellent low-light performance with 3D noise reduction, saving storage and bandwidth together with H.265 codec

## Flexible Surveillance Solution

- 4.5–135 mm, F1.6–F4.4, 30x optical zoom lens with 360° continuous rotation for the flexibility to clearly view the target area with desired width and depth
- H.265, H.264 and MJPEG codec, triple stream support
- Waterproof (IP67/IP66) and IK10 vandal resistant camera housing (IP67 only for HDZ302DE model, and IP66 only for HDZ302D model)
- –40°C to 70°C (–40°F to 158°F) HDZ302DE working temperature, –40°C to 60°C (–40°F to 140°F) HDZ302D working temperature, –10°C to 60°C (14°F to 140°F) HDZ302DIN working temperature
- ONVIF Profile S and G compliant
- Built-in Analytics in the camera, such as face detection, audio detection, and auto-tracking
- Security features include individual signed certificates and data encryption

## Easy to Install and Use

- Built-in High PoE (Power over Ethernet) eliminates separate power supply and associated wiring; 24 V AC input where PoE power is unavailable
- Wide range of mounting options
- Remote configuration, motorized pan, tilt and zoom adjustments and auto focus through web client



## Onboard Video Storage

Supports up to 128 GB microSDHC (Class 10) card for local video storage on events, continuous, or schedule, or with network interruption. Card not included

## Market Opportunities

The combination of the latest digital technology and advanced video processing makes HDZ ideally suited for large-scale surveillance in cities, roadways, airports, government facilities, schools and campuses, industrial environments and anywhere detailed surveillance is essential.

## FEATURES AND BENEFITS

- |  |   |  |   |  |
|--|---|--|---|--|
| <ul style="list-style-type: none"> <li>• 4.5–135 mm, F1.6–F4.4, 30x optical zoom lens</li> <li>• 1/2.8" progressive scan image sensor</li> <li>• Up to 50/60 fps primary stream</li> <li>• Up to 25/30 fps secondary streams</li> <li>• Up to triple stream support</li> </ul> | <ul style="list-style-type: none"> <li>• Ultra-low light performance</li> <li>• Global language support with 15 languages for all QIGs, Web GUI, and online help</li> <li>• Excellent low light performance with down to 0.0005 lux BW</li> </ul> | <ul style="list-style-type: none"> <li>• Electronic image stabilizer (EIS)</li> <li>• Multiple, selectable compression formats (H.265/H.264/MJPEG)</li> <li>• True WDR: 120 dB</li> <li>• Built-in Analytics, including Auto-tracking, Face detection</li> </ul> | <ul style="list-style-type: none"> <li>• Rugged outdoor housing with IK10 vandal resistance</li> <li>• Choice of 24 V AC or PoE+ power inputs</li> <li>• On board camera storage: up to 128 GB microSD card (not included)</li> </ul> | <ul style="list-style-type: none"> <li>• ONVIF profile S and G compliant</li> <li>• Waterproof IP67 ingress protection rating for HDZ302DE models and IP66 for HDZ302D models</li> <li>• Cyber security hardware chipset built-in</li> </ul> |
|--|---|--|---|--|

# WDR PTZ IP Cameras Features

The camera can be configured to automatically detect and respond to events such as motion in the scene, alarm inputs, network failure, and/or camera tampering. Automated responses include: sending a notification through email, FTP, and/or HTTP; sending a still image of the event through email and/or FTP; and recording a video clip of the event to a configured microSDHC card. Setup can be done through a web client.

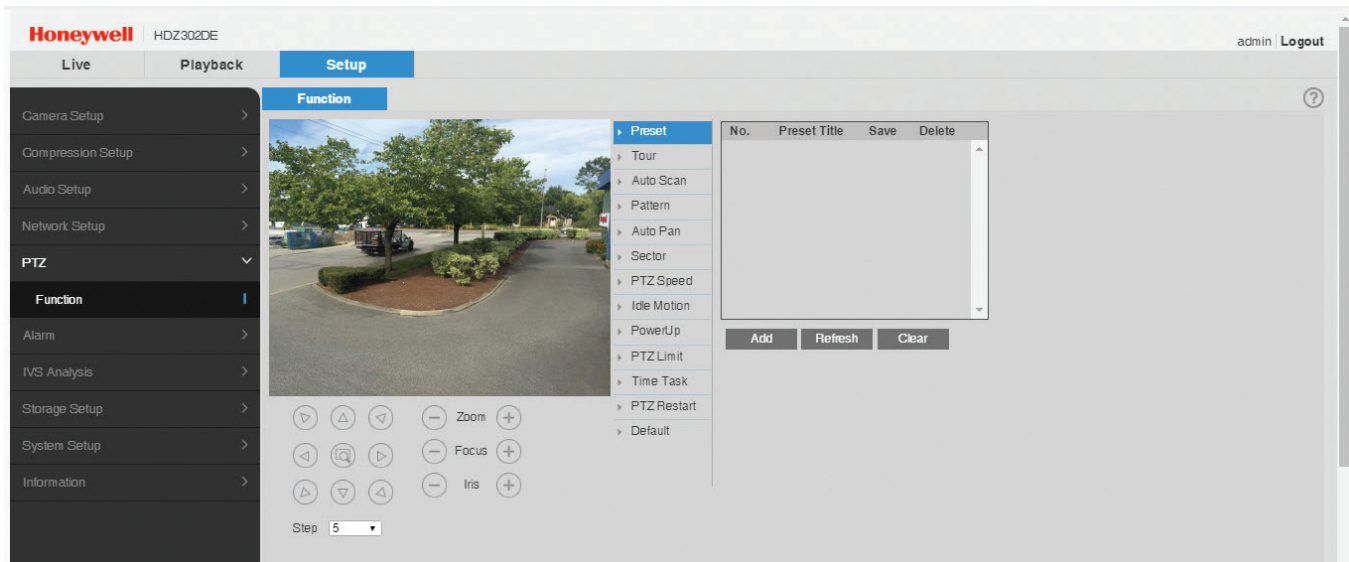

## Dimensions

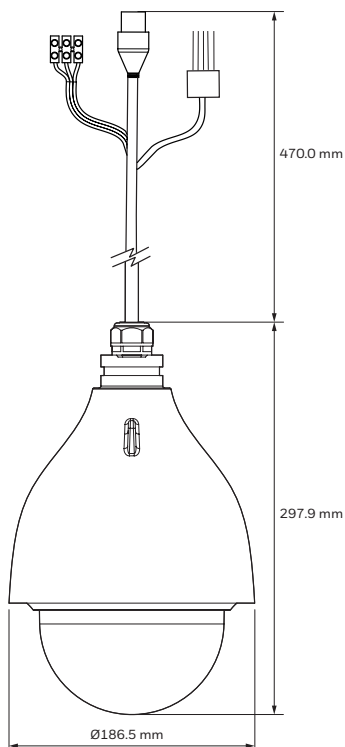

HDZ302D

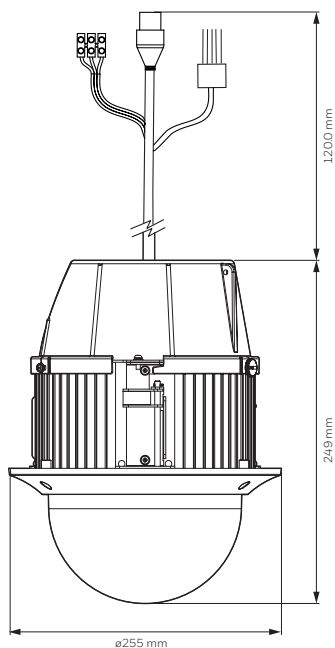

HDZ302DIN-C1/S1

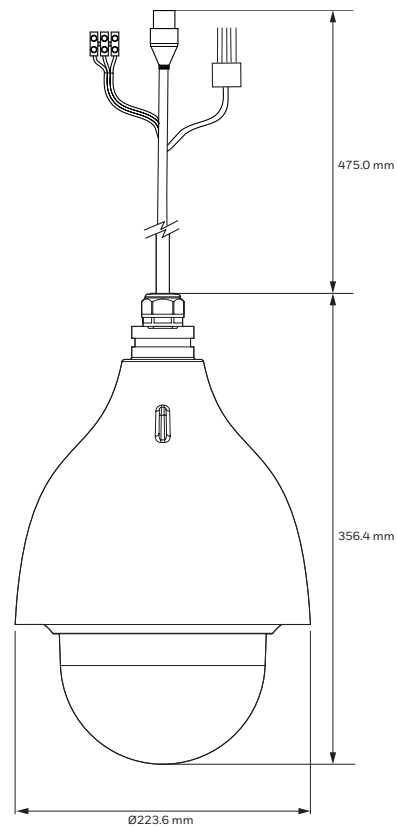

HDZ302DE

# WDR PTZ IP Cameras Technical Specifications

	HDZ302DE	HDZ302D/DIN
<b>CAMERA</b>		
Image Sensor	1/2.8" Sony Progressive CMOS	
Optical Zoom	30x	
Digital Zoom	16x	
Number of Pixels (H x V)	1920x1080 (1080p)	
Shutter WDR	120 dB	
S/N Ratio	≥ 55 dB (AGC Off)	
Minimum Illumination	0.005 lux (colour)/0.0005 lux (B/W) @ F1.6	
Focal Length	4.5 mm - 135 mm	
Max Aperture	F1.6 - F4.4	
Focus Mode	Manual/Auto/PTZ Trigger/Zoom Trigger	
Angle of View	H: 62.35° - 2.53°; V: 37.87° - 1.79°	
White Balance	Auto/Indoor/Outdoor/ATW/Manual	
Exposure Mode	Iris Priority/Shutter Priority/Gain Priority/Manual	
Electronic Shutter	1/1 to 1/30,000 sec	
Backlight Compensation	BLC / HLC / WDR	
Electronic Image Stabilization	On/Off	
Defog	On/Off	
Day/Night	Auto/Colour/BW	
<b>OPERATION</b>		
Pan Travel	360° endless	
Tilt Travel	-20° to 90°, auto flip 180°	0° to 90°, auto flip 180°
Manual Pan Speed	Up to 500°/s	Up to 400°/s
Manual Tilt Speed	Up to 400°/s	Up to 200°/s
Presets	250	
Preset Accuracy	0.2°	
Preset Speed	Pan: Up to 500°/s; Tilt: Up to 400°/s	Pan: Up to 400°/s; Tilt: Up to 200°/s
Tours	8	
Auto Pan/Scan	1 / 1	
Pattern	5	
Privacy Masks	24	
Auto Resume After Power Failure	Yes	
Motion Detection	On/Off	
Image Rotation	Flip	
Audio In / Out	1 / 1	
Alarm Input / Output	7 / 2	2 / 1
Video Analytics	Auto-tracking; Face detection; Audio detection	
Event	Motion Detect; Video Tamper; Audio Detect; No SD card; SD card error; SD card capacity warning; Network disconnection; IP address conflict; Illegal access; Face detection	
Event Notification	Record (SD card and FTP), Relay output, Email, Preset, Tour, Pattern, Snapshot	
Languages Supported	English, Arabic, Czech, Dutch, French, German, Italian, Japanese, Korean, Polish, Portuguese, Russian, Simplified Chinese, Spanish, Turkish	
<b>ELECTRICAL</b>		
Power Source	24 V AC ± 25%, 3A and PoE+ (802.3at) class 4. 24 V AC is required to run the heater operation	24 V AC ± 25%, 1.5A and PoE+ (802.3at) class 4. 24 V AC is required to run the heater operation on HDZ302D units
AC Frequency	50/60 Hz	
Power Consumption	13 W; 31 W Max (Heater On, only on 24 V AC powered units)	HDZ302D: 13 W; 23 W Max (Heater On, only on 24 V AC powered units) HDZ302DIN: 13 W

	HDZ302DE	HDZ302D/DIN
<b>MECHANICAL</b>		
Dimensions	Ø223.6 mm x 356.4 mm (Ø8.8" x 14.0"), Cable length: 475 mm (18.7")	HDZ302D: Ø186.5 mm x 297.9 mm (Ø7.3" x 11.7"), Cable length: 470 mm (18.5") HDZ302DIN: Ø255 mm x 249 mm (Ø10" x 9.8"), Cable length: 120 mm (4.7")
Product Weight	3.9 kg (8.6 lb)	HDZ302D: 2.7 kg (6.0 lb) HDZ302DIN: 2.2 kg (4.9 lb)
Connectors	Video output (AUX): BNC connector Power input: Bare wire with connectors Network: RJ45 connector Alarm I/O: Twisted wire (7 in/2 out) Audio I/O: Twisted wire (1 in/1 out) RS485: Twisted wire	Power input: Bare wire with connectors Network: RJ45 connector Alarm I/O: Twisted wire (1 in/1 out) Audio I/O: Twisted wire (1 in/1 out)
Construction Material	Aluminum	
Construction Colour	White (RAL CODE 9003)	
<b>ENVIRONMENTAL</b>		
Operating Temperature	HDZ302DE: -40°C to 70°C (-40°F to 158°F). -40°C (-40°F) cold start only for 24 V AC powered units. 24 V AC is required to run the heater operation HDZ302D: -40°C to 60°C (-40°F to 140°F). -40°C (-40°F) cold start only for 24 V AC powered units. 24 V AC is required to run the heater operation HDZ302DIN: -10°C to 60°C (14°F to 140°F)	
Storage Temperature	HDZ302DE: -40°C to 70°C (-40°F to 158°F) HDZ302D: -40°C to 60°C (-40°F to 140°F) HDZ302DIN: -40°C to 60°C (-40°F to 140°F)	
Relative Humidity	Less than 95%, non-condensing	
Waterproof Standard	IP67	IP66 (HDZ302D only)
Impact Rating	IK10 (HDZ302DIN: IK10 only for bubble)	
<b>IP SPECIFICATIONS</b>		
Video Compression	H.265 / H.264 / MJPEG	
Video Streaming	Primary Stream: 1080p @ 60/50 fps; 1.3M/720p @ 30/25 fps Second Stream: 1080p/1.3M/720p @ 30/25 fps Third Stream: D1/CIF @ 30/25 fps	
Video Resolution	Up to 1920x1080p	
Audio Compression	G.711a/G.711Mu/AAC/G.722/G.726/MPEG2-L2	
Audio Stream	Full-duplex, Simplex	
Interface	RJ-45, 10/100 Mbps Ethernet	
Supported Protocols*	IPv4/v6, TCP/IP, UDP, RTP, RTSP, HTTP, HTTPS, SSL, ICMP, FTP, SMTP, DHCP, PPPoE, UPnP, IGMP, SNMP, Bonjour, DNS, DDNS, IEEE 802.1x, QoS, NTP, IP Filter, ONVIF; HDZ302DE only: RS485, Pelco P, Pelco D	
Security	User account and password protection, HTTPS, IP Filter, IEEE 802.1x, digest authentication, user access log, TLS1.2, AES-256, SSH/Telnet closed, FTP disabled, PCI-DSS, built-in crypto chipset, UL2900-1, UL Cyber Assurance Program (UL CAP) certification	
Maximum Users Access	20 users	
MicroSD	Support for microSD up to 128 GB (card not included)	
MicroSD Function	Event trigger recording, Continuous and scheduled recording, Automatic recording when network fails	
Supported Web Browsers	Internet Explorer (11.0+), Firefox, Chrome	
Supported OS	Windows 7 32-bit/64-bit	
Communication	ONVIF Profile S and G	
<b>REGULATORY</b>		
Emissions	EN55032, FCC Part 15B; AS/NZS CISPR 22:2009+ A1 (2010)	
Immunity	EN50130-4	
Safety	EU: EN60950-1, EN60950-22 North America UL listed to UL/CSA 60950-1, 60950-22	
RoHS	EN50581	

Notes:

\*Some development may be required in specific user cases to support some of these protocols in the field as they mature over time.

# ACCESSORIES, SYSTEM COMPATIBILITY AND ORDERING

## SYSTEM INTEGRATION













### OPEN IP INTEGRATION

ONVIF support and open API software integration. Refer to [www.onvif.org](http://www.onvif.org) for the ONVIF specification and the Honeywell Open Technology Alliance website (<http://www.security.honeywell.com/hota/>) to learn more about our open and integrated solutions.





## ACCESSORIES

### HOUSINGS AND MOUNTS (HDZ302D AND HDZ302DE)

HDZNPTA		1.5" NPT Adapter
HDZWM1		Wall Mount
HDZWM2		Wall Mount with access hole
HDZCMA		Corner Mount adapter for wall mount
HDZPMA		Pole Mount adapter for wall mount
HDZCM1		Ceiling Mount
HDZJB		Junction Box
HDZGM		Wall Mount Gooseneck Bracket (HDZ302D only)
HDZCM2		Ceiling Mount extension pole for HDZCM1, 220 mm
HDZCM3		Ceiling Mount extension pole for HDZCM1, 420 mm
HDZCB5		Clear Bubble for HDZ302D
HDZSB5		Smoked Bubble for HDZ302D

### ACCESSORIES (HDZ302DIN-C1 AND HDZ302DIN-S1)

HDZINPL		In-Ceiling PTZ Camera Support Plate (Drop Ceiling)
HDZCB5IN1		Clear Bubble for HDZ302DIN-C1/S1
HDZSB5IN1		Smoked Bubble for HDZ302DIN-C1/S1

## HONEYWELL DEVICE INTEGRATION

MAXPRO® NVR FAMILY	Entry to Enterprise Level Network Video Recorders (version 4.0 and greater)
MAXPRO® VMS FAMILY	Entry to Enterprise Level Network Video VMS (version R410 and greater)
DVM	DVM R600.1 SP1
HUS	HUS 5.1

## ORDERING

HDZ302DE	Network TDN PTZ 6" Indoor/Outdoor Dome, 1080p Resolution, 30x Zoom, WDR, H.265/H.264, NTSC/PAL, IK10, IP67, micro SD Card Compatible (Supports up to 128 GB cards, card not included)
HDZ302D	Network TDN PTZ 5" Indoor/Outdoor Dome, 1080p Resolution, 30x Zoom, WDR, H.265/H.264, NTSC/PAL, IK10, IP66, micro SD Card Compatible (Supports up to 128 GB cards, card not included)
HDZ302DIN-C1	Network TDN PTZ Indoor, In-Ceiling Dome Clear Bubble, 1080p Resolution, 30x Zoom, WDR, H.265/H.264, NTSC/PAL, IK10, micro SD Card Compatible (Supports up to 128 GB cards, card not included)
HDZ302DIN-S1	Network TDN PTZ Indoor, In-Ceiling Dome, Smoke Bubble, 1080p Resolution, 30x Zoom, WDR, H.265/H.264, NTSC/PAL, IK10, micro SD Card Compatible (Supports up to 128 GB cards, card not included)

### NOTE:

Honeywell reserves the right, without notification, to make changes in product design or specifications.

'ONVIF' and  |  are trademarks of ONVIF Inc.

### For more information

[www.security.honeywell.com/uk](http://www.security.honeywell.com/uk)

### Honeywell Commercial Security

Aston Fields Road  
Whitehouse Industrial Estate  
Runcorn  
Cheshire  
WA7 3DL  
UK  
Tel: 08448 000 235  
Fax: +44 (0)1928 754 050  
[www.honeywell.com](http://www.honeywell.com)

HSV-HDZ30WDRPTZ-03-UK(1018)DS-E  
© 2018 Honeywell International Inc.

**Honeywell**