

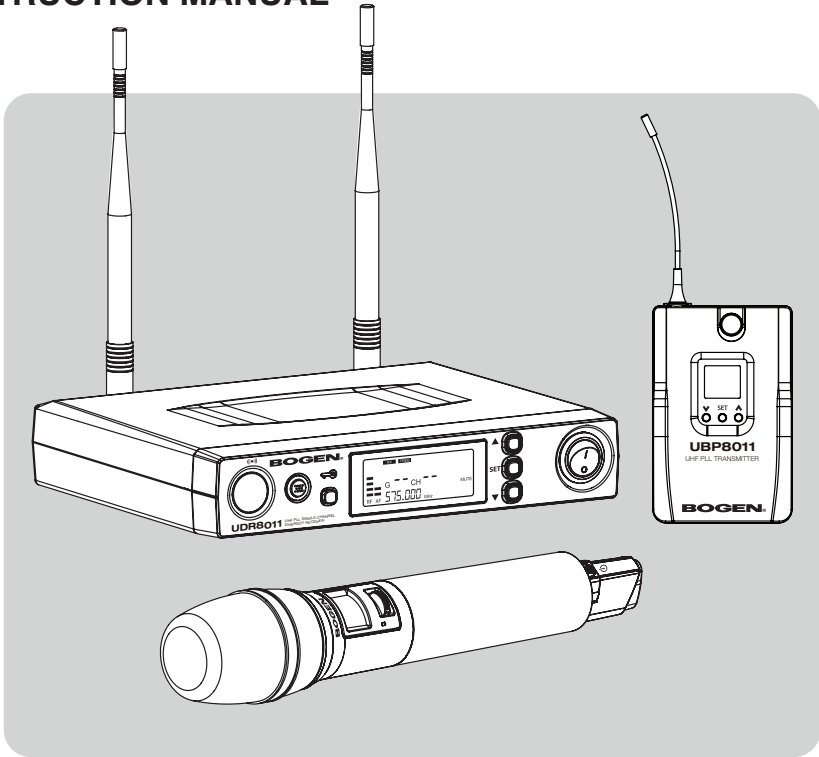

Model

UHF8011BP/HH

UHF PLL SINGLE CHANNEL DIVERSITY
WIRELESS SYSTEM
INSTRUCTION MANUAL



BOGEN[®]
COMMUNICATIONS, INC.
www.bogen.com

©2018 Bogen Communications, Inc.
Specifications are subject to change.
740-00078A 1811

TABLE OF CONTENTS

1. Notes for System Operation _____	1
2. Features _____	1
3. Model Specifications _____	2
3-1 UDR8011 UHF PLL Single Channel Diversity Receiver	2
3-2 UHT8011 UHF PLL Hand Held Transmitter	3
3-3 UBP8011 UHF PLL Body Pack Transmitter	3
3-4 BCLM1 Condenser Lavalier Microphone	4
3-4 UHFHSMB Headset Microphone	4
4. Description of Parts _____	5
4-1 UDR8011 Receiver Unit Callouts - Front View	5
4-2 UDR8011 Receiver Unit Callouts - Rear View	6
4-3 UDR8011 Receiver LCD Display Callouts	7
4-4 UHT8011 Hand Held Transmitter Callouts	8
4-5 UBP8011 Body Pack Transmitter Callouts	9
4-6 BCLM1 Condenser Lavalier Microphone Callouts	10
4-7 UHFHSMB Headset Microphone Callouts	10
4-8 Accessories	
5. Connecting _____	11
5-1 How to Connect to the UDR8011 Receiver	11
5-2 1. UHT8011 Hand Held Transmitter Installation	12
2. UBP8011 Body Pack Transmitter Installation	12
6. Instructions for Use _____	13
6-1 1. How to Set UDR8011 Receiver Parameters	13-14
2. UDR8011 Receiver Volume Adjustment	15
3. UDR8011 Receiver Sync Pairing	15
6-2 How to Set UHT8011/UBP8011 Transmitter Parameters	16-17
7. Additional Product Instructions _____	18
8. Wireless System Frequency List _____	19
9. Warranty _____	20

1. Notes for System Operation

- Before connecting the power, check that the power requirement shown on the unit is the same as the power output on the adapter supplied.
- Do not operate the unit where humidity and temperature are high.
- Dry your hands before operating the system.
- Keep the unit away from fire and heat source.
- Turn the volume to minimum on both the mixer and amplifier before setting up and powering on the system.

2. Features

- Six groups are provided as default. Groups can contain up to 22 default channels.
- 1,440 channels to choose from.
- 36MHz Bandwidth
- Ultrasonic pairing for synchronized setting of all parameters between receiver and transmitter.
- Channel Scan capable
- Adjustable Receiving Sensitivity
- Digital Volume Control
- Automatic Transmitter Power Off

3. Model Specifications

3-1 UDR8011 UHF PLL Single/Dual Channel Diversity Receiver

MODEL	UDR8011
Frequency Mode	Phase-locked loop (PLL)
Frequency Range	470 ~ 960 MHz
Sync Frequency	Ultrasonic
Bandwidth	36 MHz
Signal/Noise Ratio	> 105 dB(A)
Total Harmonic Distortion (Thd)	< 0.6% @ 1kHz
Receiving Sensitivity	-95 dBm (S/N > 80 dB)
Rejection Ratio	> 80 dB
Frequency Response	50 Hz ~ 16 kHz ± 2 dB
Antenna Type	1/2 λ BNC detachable, diversity
Antenna Power	12-15 VDC / 100mA
Display Type	LCD
Controls	Power, Set, ▲ / ▼ , Button Lock, Sync
Display Functions	Group, channel, frequency, battery level, antenna A/B, muting level, AF indication, RF indication, channel scanning, output level attenuation, volume indication
Audio Frequency Output Level	Ref : ± 22.5 kHz Dev @ 1 kHz Tone
	1/4" Phone Jack: -10 dBV (unbalanced)
	XLRM Jack : -4 dBV (Line), -24 dBV (MIC) (balanced)
Audio Output Impedance	600Ω
Muting	Noise/Squelch muting
Output Port	1 x balanced XLRM Jack 1 x unbalanced 1/4" TS Jack
Power Supply	12-15 VDC / 300mA
Dimensions	8.35" (W) x 1.5" (H) x 5.6" (L)

3-2 UHT8011 UHF PLL Hand Held Transmitter Microphone

MODEL	UHT8011
Frequency Mode	Phase-locked loop (PLL)
Frequency Range	470 ~ 960 MHz
Sync Frequency	Ultrasonic
RF Power Output	10m W / 50m W (as per local regulations)
RF Stability	< ± 10 kHz @ Fc
Modulation Frequency	± 48 kHz
Harmonic Radiation	< -50 dBc
Display	LCD + LED
Controls	Power, Mute, Set, ▲ / ▼ , Button Lock
Functions	Mute, auto off, sensitivity adjustment, group, channel, frequency
Battery	AA alkaline battery or NiMH rechargeable battery (x 2)
Charging	Yes
Dimensions	2" (W) x 10.5" (H)

3-3 UBP8011 UHF PLL Body Pack Transmitter

MODEL	UBP8011
Frequency Mode	Phase-locked loop (PLL)
Frequency Range	470 ~ 960 MHz
Sync Frequency	Ultrasonic
RF Power Output	10m W /50 m W (as per local regulations)
RF Stability	< ± 10 kHz @ Fc
Modulation Frequency	± 48 kHz
Harmonic Radiation	< -50 dBc
Functions	Mute, auto off, sensitivity adjustment, input level attenuation, group, channel, frequency
Display	LCD + LED
Input	4-pin Mini XLR
Controls	Power, Mute, Set, ▲ / ▼
Battery	AA alkaline battery or NiMH rechargeable battery (x 2)
Charging	Yes
Dimensions	2.4" (W) x 3.8" (H) x 0.78" (L)

3-4 BCLM1 Lavalier Microphone

MODEL	BCLM1
Connector	4P Mini XLR
Frequency Response	100 ~ 15,000 Hz
Polar Pattern	Cardioid
Sensitivity(at 1000Hz)	-60 ± 3 dB*
Impedance	2.2k Ω
Max. SPL for 1% THD	130 dB
Dimensions	Ø 0.39" (W) x 1" (H)
Net Weight	0.75 oz.

*0dB = 10V/pa

3-5 UHFHSMB Headset Microphone



MODEL	UHFHSMB
Connectors	4P Mini XLR
Frequency Response	100 ~ 18,000 Hz
Polar Pattern	Cardioid
Sensitivity (at 1000Hz)	-65 ±3 dB*
Impedance	1.8 k Ω
Max. SPL for 1% THD	120 dB
Dimensions	4.9" (W) x 5.2" (H) x 6.2" (D)
Net Weight	0.63 oz. (cable excluded)

*0dB = 10V/pa

4. Description of Parts

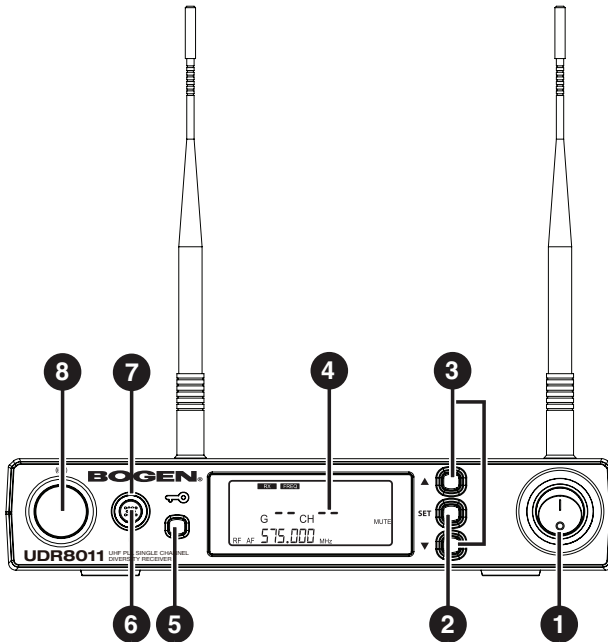
4-1 UDR8011 Receiver Feature Callouts - Front View



- ① **POWER:** I = ON and O = OFF
- ② **SET:** Push and hold for 2 seconds to enter the Setting Mode. Push **SET** to advance to the next parameter.
- ③ **▲/▼:** In the Setting Mode, push ▲/▼ to change the parameter value. In the non-Setting Mode: push ▲/▼ to adjust audio output volume.
- ④ **LCD Display:** System Information (see page 7 for features).
- ⑤ **LOCK** : Push and hold for 2 seconds to lock the front panel buttons. Repeat to unlock front panel buttons
- ⑥ **SYNC** : This allows you to pair the transmitter after modifying a parameter. Push **SYNC** to synchronize the settings to the transmitter.
- ⑦ **SYNC Indicator:** This shows the current pairing status. It flashes rapidly when data is being transmitted and the flashing stops when the synchronization is completed. However, the flashing slows down if synchronization fails after a period of time.
- ⑧ **Ultrasonic Sync Transmission Element:** Transmits digital pairing data at ultrasonic frequency. When setting, direct line of sight is required between ultrasonic elements of receiver & transmitter. The effective range is 30° on both sides off-axis with the maximum distance of 12”.

4-2 UDR8011 Receiver Feature Callouts - Rear View

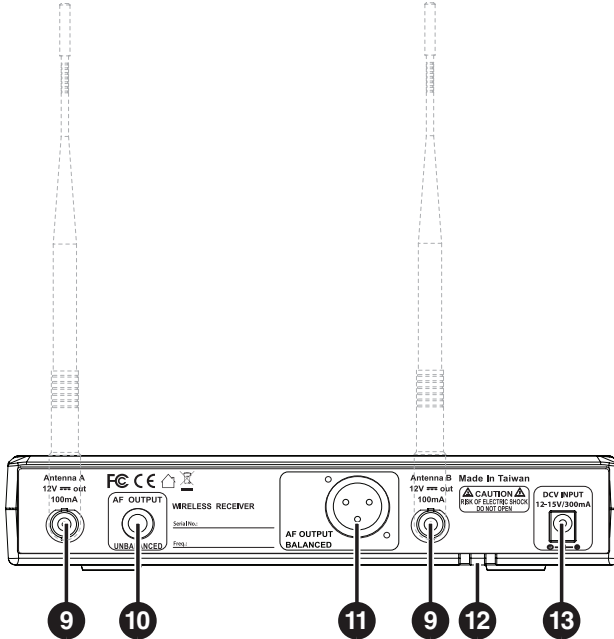

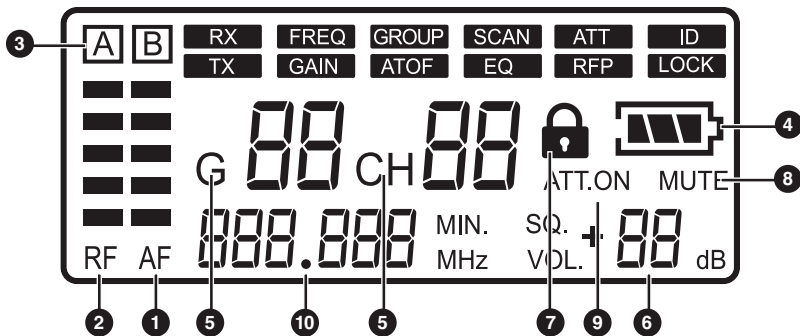

- 9 RECEIVING ANTENNA:** BNC connection for $1/2\lambda$ antenna.
- 10 PHONE JACK (1/4" TS):** Unbalanced audio output jack.
- 11 3P XLR MALE:** Balanced audio output jack.
- 12 STRAIN RELIEF:** Securement for DC power cable.
- 13 DC POWER SOCKET:** 12-15 VDC / 300mA power supply.

4-3 UDR8011 Receiver LCD Display



Shown above in the non-Setting Mode

- ① AF : Audio Signal strength
- ② RF : RF Signal strength
- ③ [A] [B] : Antenna A or B active
- ④  : Transmitter Battery Level
- ⑤ G 00 / CH 00 : Group/Channel
- ⑥ VOL. + 00 dB : Volume Output
- ⑦  : Button Lock
- ⑧ MUTE : Receiver/Transmitter Mute
- ⑨ ATT.ON : Output Attenuation
- ⑩ 000.000 MHz : Frequency

4-4 UHT8011 Hand Held Transmitter Feature Callouts

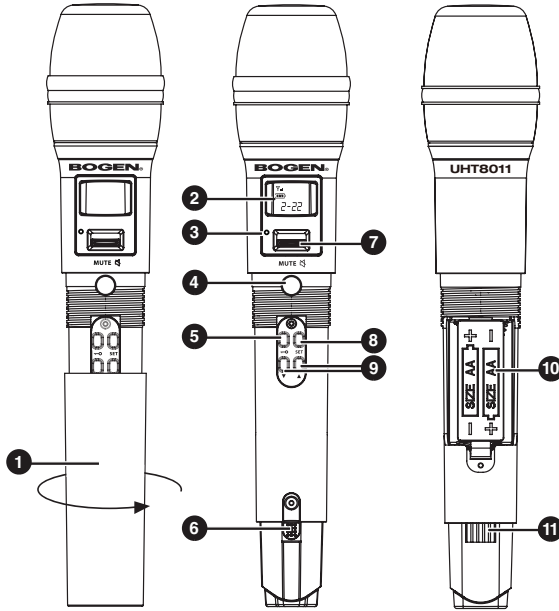

- ❶ **DETACHABLE CAPSULE MODULE:** Mic capsule detachable by unscrewing.
- ❷ **LCD DISPLAY:** Displays the parameter settings in the transmitter.
- ❸ **LED INDICATOR:** Displays the transmitter's status, including battery level, mute and pairing indication.
- ❹ **ULTRASONIC RECEIVING ELEMENT:** Receives pairing signals from the ultrasonic element at the receiver end.
- ❺ **⏏:** Push and hold button for 2 seconds to lock the buttons/controls. Push and hold again for 2 seconds to unlock.
- ❻ **POWER:** Push to turn the transmitter on. When the transmitter is on, push and hold for 2 seconds to turn it off.
- ❼ **MUTE:** When transmitter is on, slide switch UP to talk and DOWN to mute. If the transmitter is off, slide switch UP to turn the unit on. The transmitter turns off automatically after 1, 10, or 30 minutes of Mute mode, depending on the parameter setting.
- ❽ **SET:** Push and hold for 2 seconds to enter the Setting mode. Push SET to advance to the next parameter.
- ❾ **▲/▼:** In the Setting mode, push ▲/▼ to change the parameter value.
- ❿ **BATTERY HOLDER:** Holds AA 1.5V battery or rechargeable NiMH battery (x 2).
- ⓫ **CHARGING CONTACT:** If rechargeable batteries are used, this microphone can be recharged with optional charger (UHFDCD).

4-5 UBP8011 Body Pack Transmitter Feature Callouts

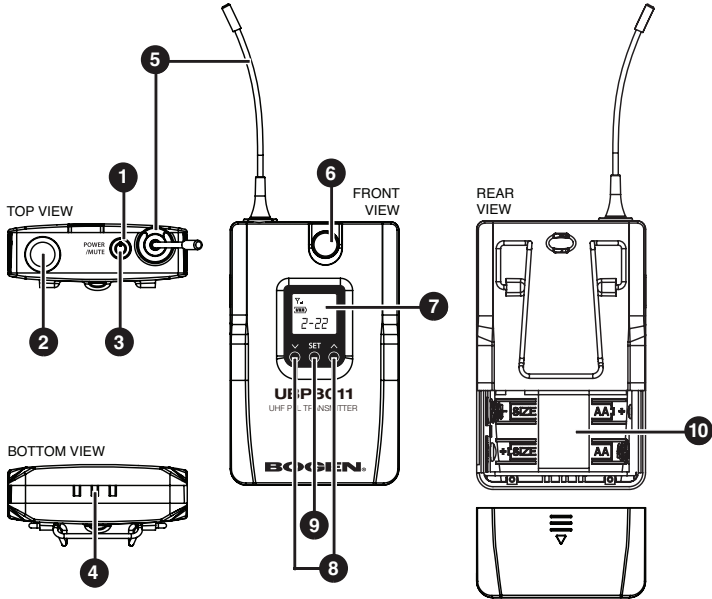

- ❶ **LED INDICATOR:** Indicates the transmitter's status, including battery level, mute and pairing indication.
- ❷ **MICROPHONE INPUT PORT:** 4P mini XLR jack
- ❸ **MUTE/POWER:** Push once to turn the unit on. While the unit is on, push once to mute and push again to unmute. Push and hold for 2 seconds to turn off.
- ❹ **CHARGING CONTACT:** If rechargeable batteries are used, this transmitter can be recharged with an optional charger (UHFDCD).
- ❺ **ANTENNA:** The antenna of transmitter
- ❻ **ULTRASONIC RECEIVING ELEMENT:** It receives the pairing signals from the ultrasonic transmission unit at the receiver end.
- ❼ **LCD DISPLAY:** Displays the parameter settings in the transmitter.
- ❽ **▲/▼:** In the Setting mode, push ▲/▼ to change the parameter value.
- ❾ **SET:** Push and hold for 2 seconds to enter the Setting mode. Push SET to advance to the next parameter.
- ❿ **BATTERY HOLDER:** Holds AA 1.5V battery or rechargeable NiMH battery (x 2).

4-6 BCLM1 Condenser Lavalier Microphone (Standard with UB8011)

- 1 MIC CLIP
- 2 MICROPHONE
- 3 WINDSCREEN
- 4 4-PIN MINI XLR

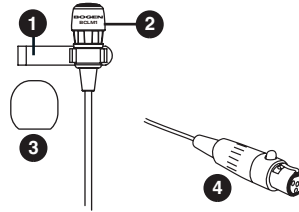

4-7 UHFHSMB Headset Microphone (optional for UB8011)

- 1 ADJUSTABLE HEADBAND
- 2 GOOSENECK
- 3 MICROPHONE
- 4 WINDSCREEN
- 5 4-PIN MINI XLR

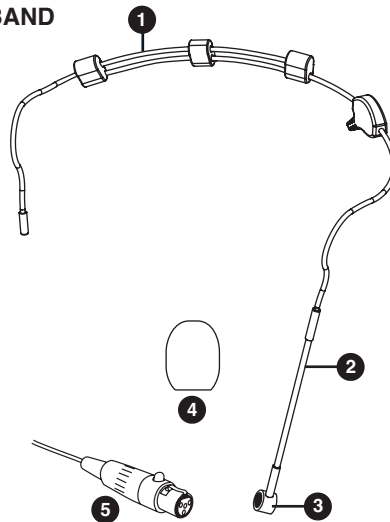

4-8 Included Accessories

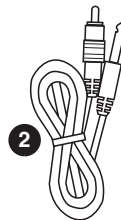
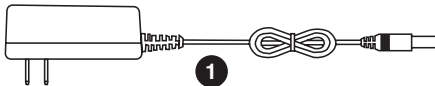

- 1 **AC/DC ADAPTOR (UDR8011-RPS):**
AC IN: AC100~240V, 50/60Hz
DC OUT: DC12V/0.5A
- 2 **AF OUTPUT CABLE:** (with 1/4" plug to RCA plug ends)

5. Connecting

5-1 How to Connect the UDR8011 Receiver

1. Connect the audio output of receiver to mixer or amplifier

1.1 UDR8011 Receiver

The XLR balanced output jack or 1/4" unbalanced output jack can be used to connect the audio output to a mixer or an amplifier.

2. Connect the Power

2.1. Connect the AC/DC adapter:

Check that the DC current and voltage ratings of the adapter match the label on the unit. Connect the DC terminal to the DC input port on the unit and the AC end to an AC outlet.

2.2. Set the parameters:

Turn the power on and set the parameters of the receiver according to the instructions (section 6.1).



CAUTION! Secure the power cable on the strain relief fastening hook to prevent the power cable from accidental removal.

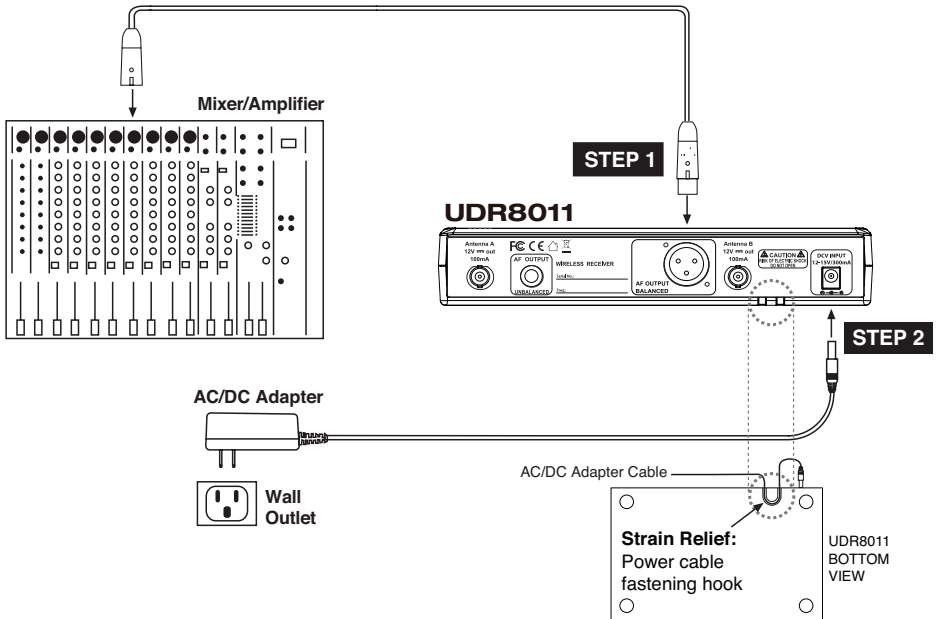

5-2 Transmitter Installation

1. UHT8011 Hand Held Transmitter

1. Unscrew the outer tube of the transmitter (Fig. 1).
2. Open panel door and place 2 AA batteries in the battery holder, ensuring they are in the correct polarities (Fig. 2).
3. Screw the outer tube on (Fig. 3).
4. To turn the unit on:
 - a. Push the Power button to turn the unit on (Fig. 4a), or
 - b. Push the Mute switch up to turn the unit on (Fig. 4b).
5. Set the transmitter parameters according to the instructions (section 6-2).

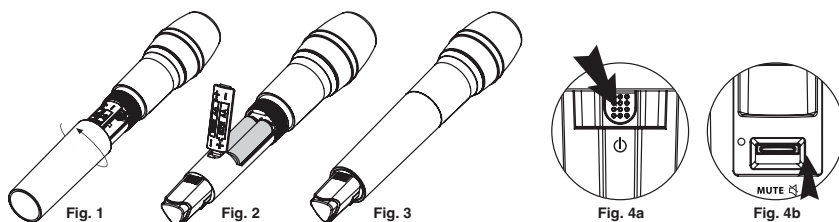

2. UBP8011 Body Pack Transmitter

1. Slide the battery holder cover downwards (Fig. 1).
2. Place 2 AA batteries in the battery holder ensuring they are in the correct polarities (Fig. 2).
3. Slide the battery holder cover upwards to close (Fig. 3)
4. Insert the microphone 4-pin mini XLR into the body pack jack (Fig. 4).
5. Push the Power button to turn the unit on (Fig. 5).
6. Set the transmitter parameters according to the instructions (section 6-2).

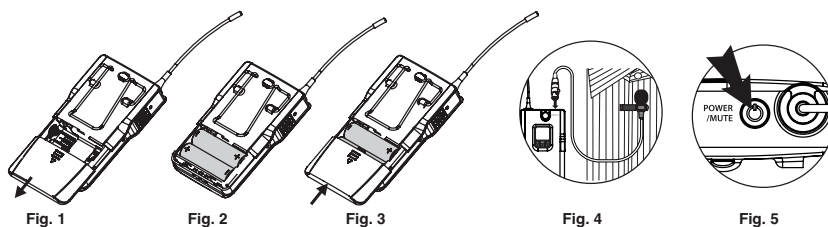

6. Instructions for Use

6-1 UDR8011 Receiver

1. Parameter Setting

Push and hold the **SET** button to enter the Setting mode. Push the **▲/▼** button to select parameter. Push **SET** again to advance to the next parameter.

When RX receiver is selected:

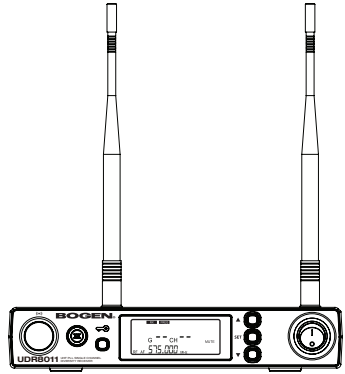

GROUP: Group / Channel

G: group	Select default group 1~6
CH: channel	Select default channel, 1~22 (max.)

Note: When Channel Scan is **ON**, **▲/▼** will scan for the next available channel.

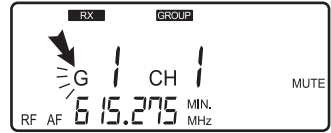

Select the group when **G** is flashing; select the channel when **CH** is flashing.

FREQ: Frequency Setting

In 1 MHz	Select frequency with ▲/▼
In 0.025MHz	Select frequency with ▲/▼

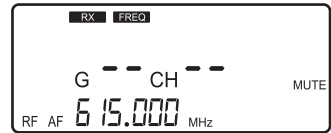

Select the number of frequency first in MHz and then in 0.025 MHz.

SCAN: Channel Scan

SC off	CH: Channel will increment sequentially.
SC on	CH: Channel will scan for the next available channel, avoiding interference.



This function is deactivated.

ATT: Audio Output Attenuation (XLR)

At off	No attenuation at audio output
At on	20 dB attenuation at audio output



This function is deactivated.

SQ: Squelch Sensitivity

-5~+10dB	-5 is the maximum sensitivity.
	+10 is the minimum sensitivity.
	The default setting is 0.



The default setting is 0.

When TX transmitter is selected:

⦿ ATT: Microphone Audio Input Attenuation

At off	No attenuation.
At on	20 dB attenuation at audio input).

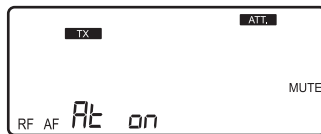

The function is activated with 20 dB of audio input attenuation.

⦿ GAIN: Microphone Input Sensitivity

High Sensitivity	GAIN: +15 dB
	GAIN: +12 dB
	GAIN: +9 dB
	GAIN: +6 dB
	GAIN: +3 dB
Default	GAIN: 0 dB
	GAIN: -3 dB
	GAIN: -6 dB
Low Sensitivity	GAIN: -9 dB
	GAIN: -12 dB
	GAIN: -15 dB



Shows the microphone input sensitivity is now at 0 dB (default setting).

⦿ ATOF: Automatic Turn Off Timer

AO OF	This function is deactivated.
AO 1	1 minute shutdown.
AO 10	10 minute shutdown.
AO 30	30 minute shutdown.

The default setting is 10 minutes.



This function is deactivated. When active, the transmitter will shutdown only when in MUTE mode.

⦿ RFP: RF Transmitter Power

The transmitter comes with 2 stages of RF power output (as per local regulations).

rF Lo	10mW
rF Hi	50mW

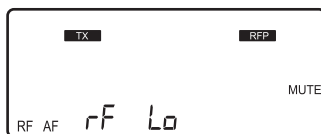

Shows that the RF Output is LO (10mW)

⦿ RC: (Resync Configuration)

rC-FrE	Only frequency setting will be synchronized
rC-ALL	All settings will be synchronized

The default setting is rC-FrE.

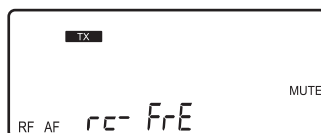

Only frequency setting will be synchronized during pairing.

2. Volume Adjustment

In non-Setting Mode, adjust the volume from 0 to -31 dB using the ▲/▼ button.

- The minimum volume is **-31 dB**.
- The maximum volume is **0 dB**.
- The default setting is **-10 dB**.

Note: This Volume affects the balanced and unbalanced outputs

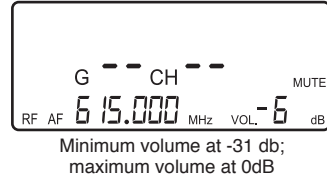

3. Sync Pairing

Once the parameters are set, push the **SYNC** button and the digital pairing data will be sent to the transmitter via ultrasonic transmission for parameter synchronization. The indicator will flash rapidly while the data is being transmitted. When the synchronization is completed, the indicator will stop flashing. If the signal is not received for a certain period of time, the indicator will flash slowly to inform pairing failure (the slowly flashing indicator can be reset by pushing any button).

Note: The best pairing distance is 12-inches, $\pm 30^\circ$. Line of Sight is required.

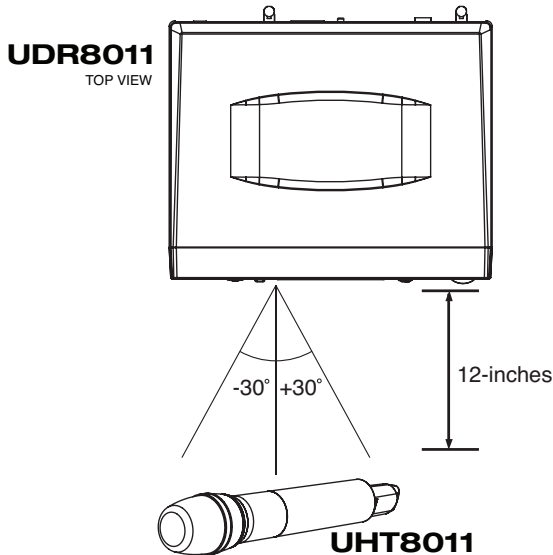

4. Battery Level

The Transmitter's battery level is also shown on the LCD display. If the battery level is $\leq 2V$, the frame around the battery level will flash and the backlight turns Red as a warning .

6-2 UHT8011 Hand Held Transmitter and the UBP8011 Body Pack Transmitter

1. Parameter Setting

Push and hold the **SET** button to enter the Setting mode. Push the **▲/▼** button to select parameter. Push **SET** again to advance to the next parameter.

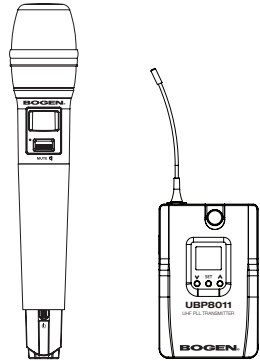

UHT8011

UBP8011

◎ **GROUP: Group / Channel**

G: group	Select default group 1~6
CH: channel	Select default channel, 1~22 max.

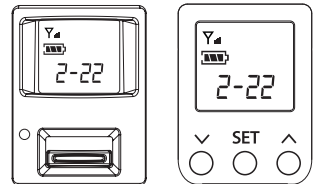

Select the number for group and then the number for channel.

◎ **FREQ: Frequency Setting**

In 1MHz	Select frequency with ▲/▼
In 0.025MHz	Select frequency with ▲/▼

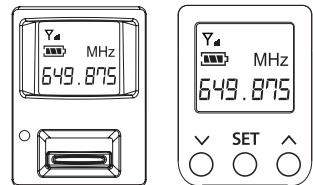

Select the number of frequency first in MHz and then in 0.025 MHz.

◎ **GAIN: Microphone Input Sensitivity**

High Sensitivity	GAIN: +15 dB
	GAIN: +12 dB
	GAIN: +9 dB
	GAIN: +6 dB
	GAIN: +3 dB
Default	GAIN: 0 dB
	GAIN: -3 dB
	GAIN: -6 dB
	GAIN: -9 dB
	GAIN: -12 dB
Low Sensitivity	GAIN: -15 dB

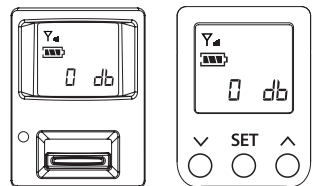

Sensitivity set at GAIN 0 dB (default setting).

⊙ **ATT: Microphone Audio Input Attenuation**

At off	No attenuation.
At on	20 dB attenuation at audio input).

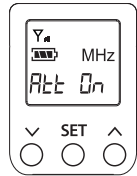

Audio input attenuation at 20 dB.

⊙ **RFP: RF Transmitter Power**

rFP Lo	10mW
rFP Hi	50mW

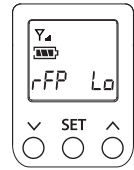
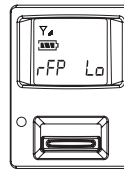

The RF output is LO.

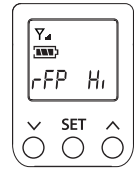
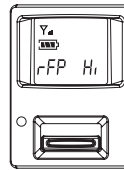

The RF output is Hi.

⊙ **ATOF: Automatic Turn Off Timer**

OFF	This function is deactivated.
1	1 minute shutdown.
10	10 minute shutdown.
30	30 minute shutdown.

(The default setting is 10 minutes)

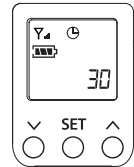
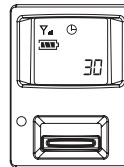

When active, the transmitter will shutdown only when in MUTE mode.

⊙ **Key Lock**

Loc on	Lock ON
Loc off	Lock OFF

Note: When Lock is **ON**, push and hold **SET** button for 2 seconds to enter Lock Disable.

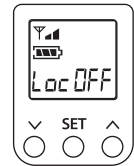
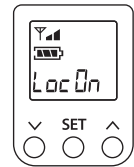

7. Additional Product Instructions

1. For the best Sync results, always keep the UHT8011/UBP8011 transmitter within 12-inches of the UDR8011 receiver with Line of Sight.
2. The UDR8011 receiver and UHT8011/UBP8011 transmitter must be away from other metal objects, preferably 20-inches or farther.
3. It is recommended to hold the UHT8011 transmitter (microphone) at the mid-section for the best signal.
4. If the UHT8011/UBP8011 transmitters will not be in use for an extended period of time, the batteries should be removed from the battery holder.
5. For the best power performance, it is recommended to change both batteries.

8. Wireless System Frequency List

Frequency Range : 534-570MHz

59563-015-01

Group1	
1	534.325
2	537.200
3	539.450
4	540.700
5	543.450
6	546.450
7	550.200
8	551.700
9	556.325
10	558.825
11	560.200
12	564.325
13	566.700
14	567.700

Group2	
1	534.000
2	535.000
3	537.375
4	538.875
5	544.750
6	547.250
7	549.375
8	552.875
9	554.750
10	559.000
11	560.750
12	563.000
13	565.750
14	567.750
15	569.375

Group3	
1	534.600
2	536.475
3	537.850
4	539.850
5	541.600
6	544.725
7	545.750
8	548.225
9	550.100
10	551.100
11	552.475
12	555.725
13	558.225
14	559.650
15	562.100
16	562.975
17	564.150
18	564.850
19	567.350
20	568.850
21	569.475

Group4	
1	534.525
2	535.525
3	537.400
4	538.775
5	541.775
6	544.400
7	545.975
8	546.650
9	548.400
10	549.800
11	552.025
12	552.775
13	556.650
14	558.525
15	560.150
16	562.650
17	564.525
18	565.525
19	567.025
20	567.900
21	569.150
22	569.850

Group5	
1	534.825
2	535.575
3	537.325
4	537.950
5	538.825
6	540.025
7	541.700
8	544.825
9	546.950
10	548.325
11	549.950
12	553.325
13	554.575
14	557.275
15	560.325
16	562.375
17	563.950
18	565.825
19	566.825
20	568.200
21	568.950
22	569.950

Group6	
1	535.300
2	536.425
3	537.925
4	538.925
5	541.175
6	543.800
7	545.050
8	547.800
9	548.425
10	550.800
11	555.300
12	556.175
13	558.300
14	560.675
15	561.800
16	563.300
17	567.050
18	567.800
19	569.175
20	569.925

9. Product Warranty

Limited Warranty: Exclusion of Certain Damages

The **Bogen UHF Wireless Systems (UHF8011-BP/HH)** are warranted to be free from defects in material and workmanship for one (1) year from the date of sale to the original purchaser. Any part of the product covered by this warranty that, with normal installation and use, becomes defective (as confirmed by Bogen upon inspection) during the applicable warranty period will be repaired or replaced by Bogen, at Bogen's option, provided the product is shipped insured and prepaid to: Bogen Factory Service Department, 4570 Shelby Air Drive, Suite 11, Memphis, TN 38118 USA. Repaired or replacement product(s) will be returned to you freight prepaid. This warranty does not extend to any of our products that have been subjected to abuse, misuse, improper storage, neglect, accident, improper installation or have been modified or repaired or altered in any manner whatsoever, or where the serial number or date code has been removed or defaced.

THE FOREGOING LIMITED WARRANTY IS BOGEN'S SOLE AND EXCLUSIVE WARRANTY AND THE PURCHASER'S SOLE AND EXCLUSIVE REMEDY. BOGEN MAKES NO OTHER WARRANTIES OF ANY KIND, EITHER EXPRESS OR IMPLIED, AND ALL IMPLIED WARRANTIES OF MERCHANTABILITY OR FITNESS FOR A PARTICULAR PURPOSE ARE HEREBY DISCLAIMED AND EXCLUDED TO THE MAXIMUM EXTENT ALLOWABLE BY LAW. Bogen's liability arising out of the manufacture, sale or supplying of products or their use or disposition, whether based upon warranty, contract, tort or otherwise, shall be limited to the price of the product. **IN NO EVENT SHALL BOGEN BE LIABLE FOR SPECIAL, INCIDENTAL OR CONSEQUENTIAL DAMAGES (INCLUDING, BUT NOT LIMITED TO, LOSS OF PROFITS, LOSS OF DATA OR LOSS OF USE DAMAGES) ARISING OUT OF THE MANUFACTURE, SALE OR SUPPLYING OF PRODUCTS, EVEN IF BOGEN HAS BEEN ADVISED OF THE POSSIBILITY OF SUCH DAMAGES OR LOSSES.** Some States do not allow the exclusion or limitation of incidental or consequential damages, so the above limitation or exclusion may not apply to you. This warranty gives you specific legal rights, and you may also have other rights which vary from State to State.

Products that are out of warranty will also be repaired by the Bogen Factory Service Department—same address as above or call 201-934-8500. Returned products which do not qualify for warranty service, may be repaired or replaced at Bogen's option with previously repaired or refurbished items. The parts and labor involved in these repairs are warranted for 90 days when repaired by the Bogen Factory Service Department. All parts and labor charges as well as shipping charges will be at the owner's expense.

All returns require a Return Authorization number. For most efficient warranty or repair service, please include a description of the failure.

10/2018

BOGEN

UHF8011BP/HH

UHF PLL SINGLE CHANNEL DIVERSITY WIRELESS SYSTEM

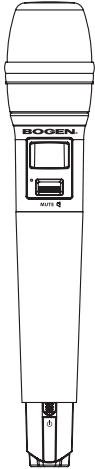

UHT8011

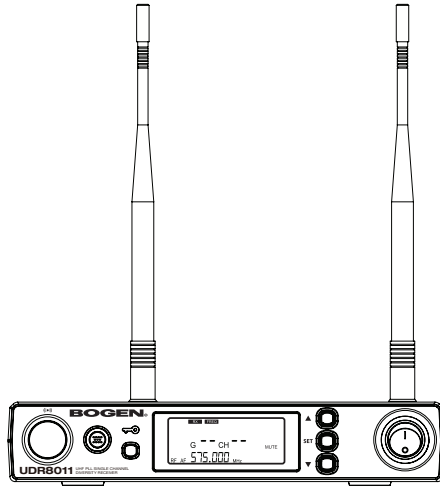

UDR8011

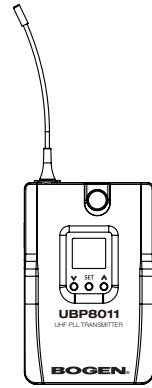

UBP8011

BOGEN
COMMUNICATIONS, INC.
www.bogen.com