

Audio Signaling & Notification Speaker

- Features**
- Industry Leading Voice Intelligibility for Reverberant Spaces
 - 123dB Max SPL @ 1 Meter
 - Rated for Indoor or Outdoor Applications
 - Universal Mounting Interface
 - 25V, 70V, & 100V or 4/8/16Ω Configurable
 - Durable Environmental Resistant Construction



Specifications (90243A-801):

Certifications: UL1480, ULC
Power Rating Up to 200W continuous
Frequency Response 250Hz – 15kHz (nominal)
Sensitivity 103.1dB @ 2.83V/1m
Dispersion Angle 187° (Horiz.) x 10° (Vert.) @ -9dB
Weight 14.7lbs
Dimensions 46.5”H x 4.9” W x 2.9” D
Temperature Range -20°C - 60°C

Description:

Designed with the latest technology in line array speaker systems, the HyperSpike® LineWave is optimized to produce clear and authoritative voice commands and powerful tones never before possible within reverberant environments. The beam forming capability of the LineWave speaker allows even coverage across the listening plane while focusing the acoustic pattern away from surfaces that cause unwanted reflections. This technology is essential for achieving optimum levels of speech intelligibility within reverberant spaces. The result is clear and intelligible direct sound that ensures critical messages are heard and understood.

90243A-801-01-L	LINEWAVE2 UL1480 20W LINEARRAY SPKR, BLACK
90243A-802-01-L	LINEWAVE4 UL1480 40W LINEARRAY SPKR BLACK
90243A-803-01-L	LINEWAVE8 UL1480 80W LINEARRAY SPKR BLACK
90243A-804-01-L	LINEWAVE16 UL1480 160W LINEARRAY SPKR BLACK
90243A-801-05-L	LINEWAVE2 UL1480 20W LINEARRAY SPKR, RED
90243A-802-05-L	LINEWAVE4 UL1480 40W LINEARRAY SPKR RED
90243A-803-05-L	LINEWAVE8 UL1480 80W LINEARRAY SPKR RED
90243A-804-05-L	LINEWAVE16 UL1480 160W LINEARRAY SPKR RED
90243A-801-06-L	LINEWAVE2 UL1480 20W LINEARRAY SPKR WHITE
90243A-802-06-L	LINEWAVE4 UL1480 40W LINEARRAY SPKR WHITE
90243A-803-06-L	LINEWAVE8 UL1480 80W LINEARRAY SPKR WHITE
90243A-804-06-L	LINEWAVE16 UL1480 160W LINEARRAY SPKR WHITE
90243A-801-07-L	LINEWAVE2 UL1480 20W LINEARRAY SPKR GREY
90243A-802-07-L	LINEWAVE4 UL1480 40W LINEARRAY SPKR GREY
90243A-803-07-L	LINEWAVE8 UL1480 80W LINEARRAY SPKR GREY
90243A-804-07-L	LINEWAVE16 UL1480 160W LINEARRAY SPKR GREY

Architect and Engineer Specifications:

Please see Models and Technical Specifications to fill in the blanks for specific speaker selection.

Voice paging and tone signaling loudspeaker shall be Ultra Electronics Model _____. Unit shall be UL 1480 Listed, weather resistant and constructed of powder coated aluminum and steel. The loudspeaker shall be able to operate within any ambient temperature environment ranging from -20°C to 60°C. The speaker shall have a sensitivity of _____ when measured at 1m (AVG 250-15,000Hz), and a horizontal beam width of 187° (AVG 1kHz to 4kHz). The transducer coils shall have a nominal 8 ohm impedance. When applicable, a minimum of four transformer power settings shall be selectable for each speaker, and it shall operate on 25V, 70V, or 100V distributed audio systems. Transformers shall contain an in-line capacitor to allow DC supervision of wiring. Frequency response shall be 250Hz-15kHz. Dimensions shall be _____”H x 4.9”W x 2.9”D.

Technical Specifications:

System	90243A-801	90243A-802	90243A-803	90243A-804
Type	Full Range, Column Loudspeaker			
Operation Mode	16/8/4Ω Loudspeaker with Optional Line Matching Transformer			
Number of Speakers in Array	2	4	8	16
Maximum Power Draw: 16Ω, 8Ω, and 4Ω Models	20W	40W	80W	160W
Max SPL @ 1m, 18V Direct Drive	105dB	111dB	117dB	123dB
Peak SPL @ 1m	113dB	119dB	125dB	131dB
Usable Range @ 80dB, A-Weighted	17m (56ft)	35m (115ft)	70m (230ft)	141m (463ft)
*Reverb SPL @ 10 ft, 18V Direct Drive	87.8	91.7	94.3	95.7
*Anechoic SPL @ 3m, 18V Direct Drive	93.4	98.0	103.0	104.0
Input Sensitivity (2.83Vrms/1m)	85dB	91dB	97dB	103dB
Nominal Impedance	16Ω	8Ω	4Ω	4Ω, 2 Channel
Vertical Coverage -9dB (Avg. 1kHz-4kHz)	99°	45°	21°	10°
Frequency Response (+/- 6dB)	250Hz-15kHz			
Required Input Signal Processing	High Pass at 200Hz – Direct Drive Models Only			
Horizontal Coverage -9dB (Avg. 1kHz-4kHz)	187°			
Maximum Input Voltage: 16Ω, 8Ω, and 4Ω Models	18V RMS, 36V Peak			
Color	Black, Red, White, Silk Grey			
Enclosure Material	Aluminum			
Grille Material	Steel			
Input Connection	SJOOW Cable, 6ft. Provided			
Ingress Protection	Indoor and Outdoor Applications			
Product Dimensions, HxWxD (in)	6.6 x 4.9 x 2.9	12.3 x 4.9 x 2.9	23.7 x 4.9 x 2.9	46.5 x 4.9 x 2.9
Net Weight (lbs)	2.6	4.3	7.5	14.7

*UL Standard SPL Measurement

25V/70V/100V Available Power and SPL Settings:

Model	Input Voltage (V)	Tap Color	Power Draw (W)	SPL Max @ 1m	*dB SPL Reverb @ 10ft	*dB SPL Anechoic @ 3m
LineWave: 90243A-801 Transformer: 72575B-801	25	Blue	0.5	86	72.4	78.2
	25	Orange	1.3	91	77.1	82.2
	25	Red	1.6	92	78.2	83.8
	25	Brown	2.7	94	79.9	85.3
	70	Blue	3.0	95	80.8	86.3
	70	Orange	8.3	100	84.9	90.7
	70	Red	10.7	101	85.9	91.9
	70	Brown	15.3	103	87.2	92.7
	100	Blue	5.7	98	83.5	89.1
	100	Orange	15.3	103	87.1	92.9
	100	Red	19.5	104	88.0	93.8
	LineWave: 90243A-802 Transformer: 72575B-801	25	Blue	0.8	92	75.8
25		Orange	2.2	97	80.5	86.6
25		Red	2.8	98	81.6	87.8
25		Brown	4.1	100	83.2	89.4
70		Blue	5.3	101	84.4	91.2
70		Orange	14.9	106	88.6	94.6
70		Red	19.3	107	89.5	95.6
70		Brown	27.4	109	90.7	96.9
100		Blue	10.3	104	87.1	92.9
100		Orange	27.8	109	90.9	96.9
LineWave: 90243A-803 Transformer: 72542B-801	25	Blue	1.7	101	79.9	87.8
	25	White	3.3	103	82.9	91.0
	25	Orange	6.6	105	85.9	94.3
	25	Yellow	12.7	108	88.5	96.6
	70	Blue	12.4	110	88.5	96.6
	70	White	23.9	112	91.2	99.5
	70	Orange	46.2	114	93.8	102.0
	70	Yellow	81.6	117	95.8	104.0
	100	Blue	23.8	113	91.2	99.0
	100	White	44.6	115	93.6	101.0
	100	Orange	83.3	117	96.0	104.0
LineWave: 90243A-804 Transformer: 72542B-802	25	Blue	3.2	106	83.3	92.1
	25	White	6.3	109	86.3	95.1
	25	Orange	12.9	111	89.3	97.4
	25	Yellow	24.3	114	91.7	100.0
	70	Blue	24.3	115	91.8	101.0
	70	White	46.6	118	94.4	103.0
	70	Orange	90.6	120	96.8	105.0
	70	Yellow	159.3	123	98.4	106.0
	100	Blue	47.8	118	94.5	103.0
	100	White	89.1	121	96.8	105.0
100	Orange	165.8	123	98.7	107.0	

(*UL Standard SPL Measurement)

Polar Plots and Beam Width:

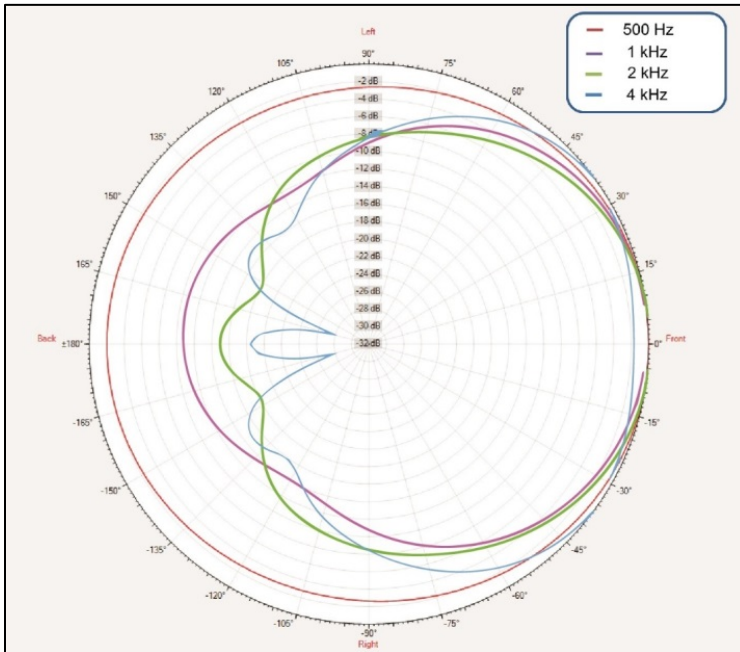

90243A-804 Horizontal Polars

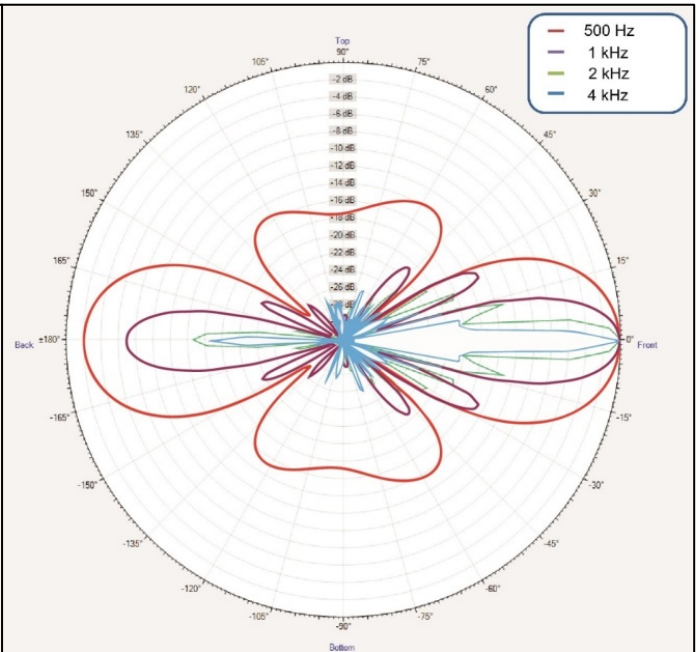

90243A-804 Vertical Polars

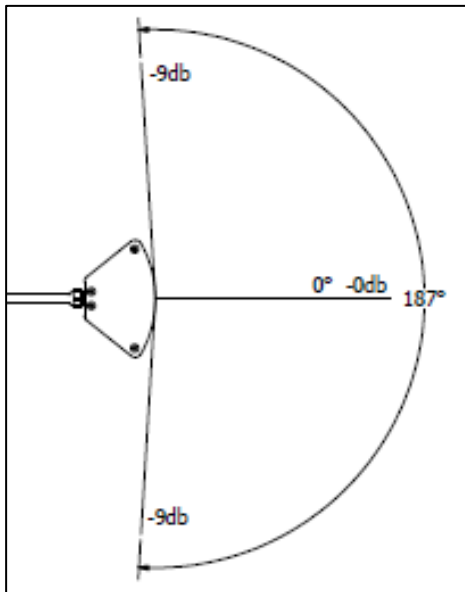

90243A-804 Horizontal Beam Width

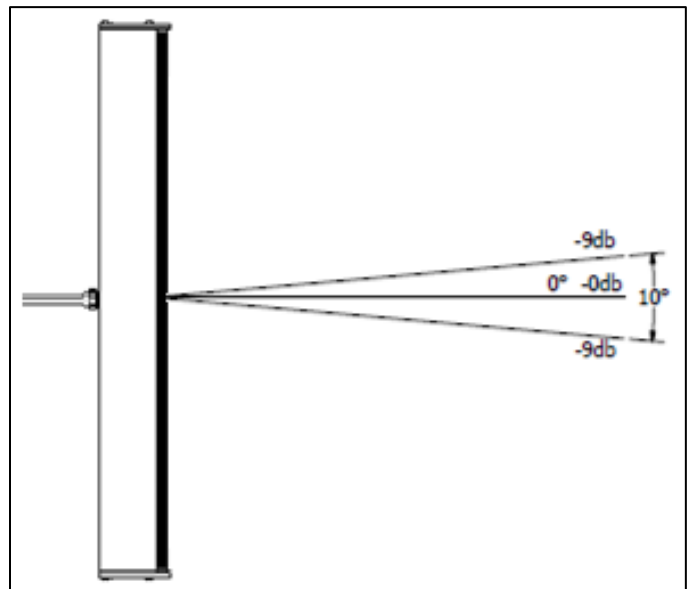

90243A-804 Vertical Beam Width

Sensitivity, 90243A-804:

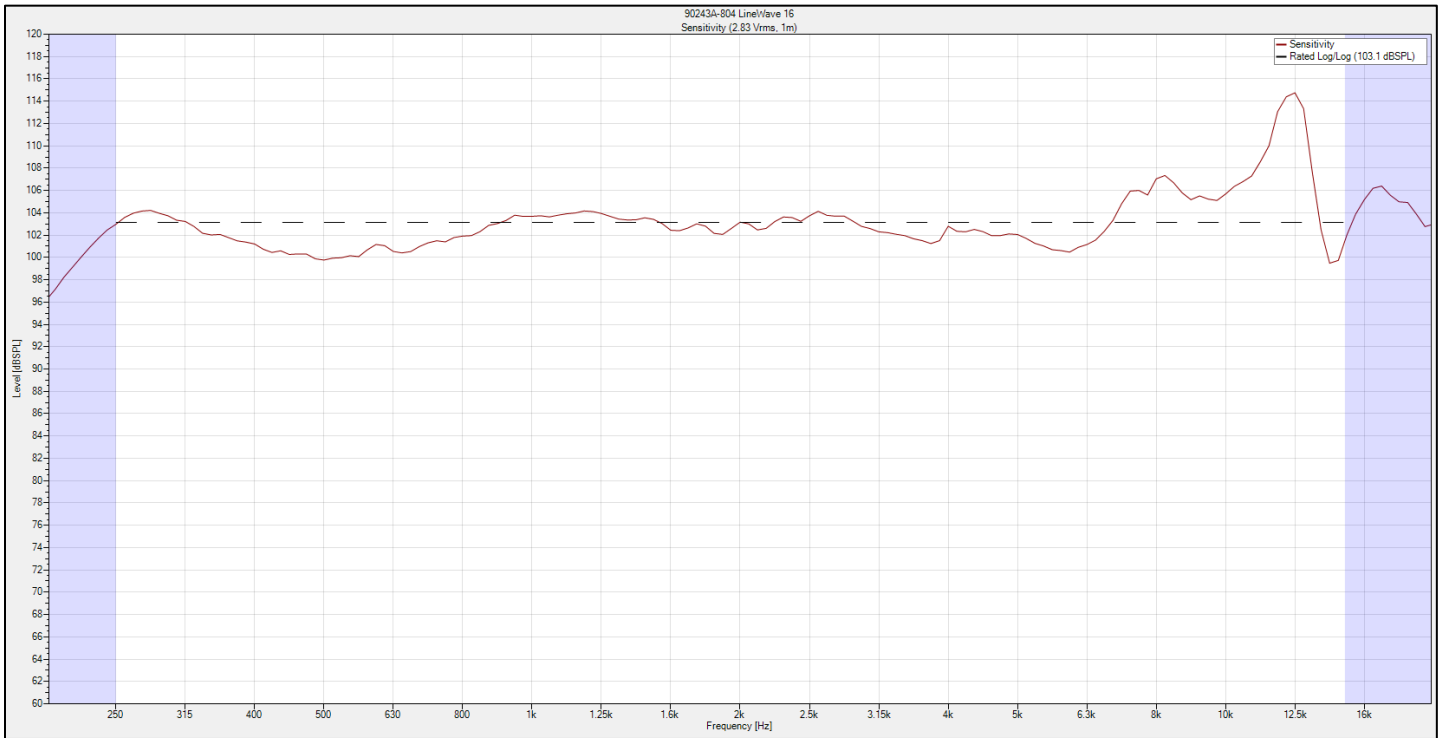

Wiring Reference:

LineWave models 90243A-801, 90243A-802, and 90243A-803 (16Ω, 8Ω, and 4Ω respectively) provide a six foot SJOOW-18/2 cable for amplifier interconnection.

LineWave model 90243A-804 provides a six foot SJOOW-18/4 cable wired as two 4Ω channels for amplifier interconnection.

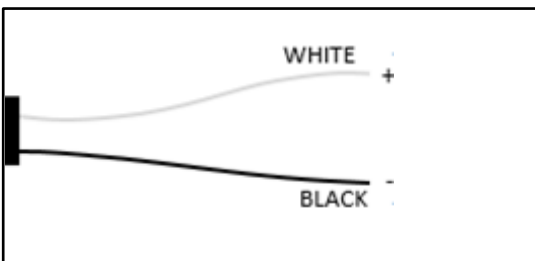

90243A-801, 90243A-802, 90243A-803

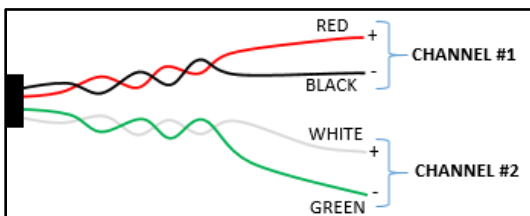

90243A-804

Mounting Reference:

All LineWave models include hardware to facilitate Wall Mounting. If it is desired to mount a LineWave to a pole, HyperSpike Pole Mount 72581B-801 is available. All mounts allow for Pan and Tilt angle adjustment after installation.

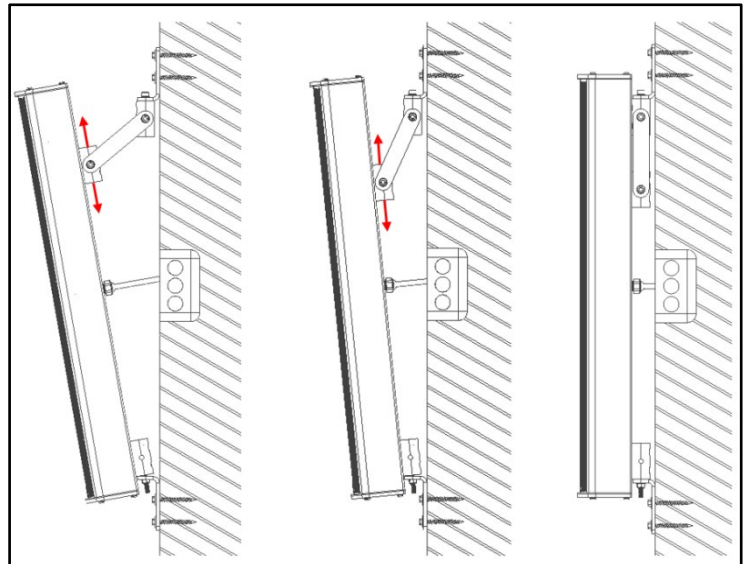

Transformer Specifications:

System	72575B-801	72542B-801	72542B-802
Type	Optional Transformer		
Operation Mode	25 / 70 /100 Watt Tap Settings		
Line Wave Compatibility <i>UL configuration available (-L) and required with the UL Listed LineWave</i>	90243A-801/802	90243A-803	90243A-804
Maximum Power Draw:	30W	85W	170W
Maximum Supervisory Voltage:	32V DC		
Enclosure Material	Plastic		
Ingress Protection	Indoor/Outdoor		
Product Dimensions, HxWxD (in)	5.9 x 5.9 x 3.9	9.8 x 5.9 x 3.9	9.8 x 5.9 x 3.9
Net Weight	3lbs	4.5lbs	6.5lbs

