

# I98

## 2MP with D/N, Adaptive IR, Extreme WDR, SLLS, 33x Zoom Lens



- 2 Megapixel
- Day & Night with Superior Low Light Sensitivity and Adaptive IR LED
- 33x Zoom Lens with f4.5-148.5mm/F1.55-F5.0, DC iris, Auto focus
- Extreme WDR
- Endless Pan & Tilt
- PTZ Auto Tracking
- Overview, Zoom and Tracking (OZT)
- Built-in Analytics
- Event trigger, response and notification

### ► Specifications

#### Device

Product Type	Speed Dome
Maximum Resolution	2MP
Application Environment	Outdoor
Image Sensor	Progressive Scan CMOS
Sensor Size	1/2.8 "
Effective Pixels	1944(H) X 1224(V) (2.38 MP)
Day / Night	Yes
Low Light Sensitivity	Superior
Minimum Illumination	Color: 0.05 lux at F1.55, B/W: 0 lux at F1.55 (IR LED on)
Color to B/W Switch	ISP based switch, configurable
Mechanical IR Cut Filter	Yes
IR Sensitivity Range	700-1100nm
IR LED	Adaptive IR LED x 8 (850 nm)
IR Working Distance	160m
Electronic Shutter	1/5-1/32000 second (manual mode); 1/5-1/32000 second (auto mode)
Horizontal Resolution (TV Lines)	1800 TVL

S/N Ratio	56 dB
-----------	-------

## Lens

Focal Length	Zoom, f4.5-148.5mm
Aperture	F1.55-F5.0
Zoom Ratio	33x optical, 16x digital
Zoom Speed	2.7 second (wide to tele)
Zoom Application	Camera Installation, Auto Zoom by Event, Manual Operation
Iris	DC iris
Focus	Auto focus
Lens Mount	Board mount
Horizontal Viewing Angle	69.3° - 3°
Vertical Viewing Angle	38° - 1.7°
Overview, Zoom and Tracking (OZT) technology	Yes (Pair of intelligent speed dome camera with B511A, B59A, B74A and B76A hemispheric camera)

## PTZ

Scan Panning / Tilting Speed	0.16° - 32°/second, 0.16° - 16°/second
Manual Panning / Tilting Speed	0.16° - 54.4°/second, 0.16° - 27.2°/second
Preset Panning / Tilting Speed	0.16° - 300°/second, 0.16° - 150°/second
Panning Range	360° endless
Tilting Range	-20°~200°
PTZ Control	Remote manual control, 256 preset points, 10 preset tours, Auto scan
Preset Accuracy (Panning/Tilting)	±0.265°/±0.265°
Absolute Position	Yes
Pan, Tilt or Zoom protocol	Visca, Pelco-D, Pelco-P, ACTi URL command

## Video

Compression	H.264 (Baseline/ Main/ High profile), MJPEG
Maximum Frame Rate vs. Resolution	60 fps at 1920 x 1080 60 fps at 1280 x 720 30 fps at 640 x 480 30 fps at 320 x 240
Multi-Streaming	Simultaneous triple streams based on three configurations
Bit Rate	128Kbps - 12Mbps (per stream)
Bit Rate Mode	Constant, Variable
Wide Dynamic Range	Extreme WDR (145 dB)
Image Enhancement	White Balance, Brightness, Contrast, Sharpness, Automatic gain control, Flickerless, Digital Image Stabilizer (DIS, EIS), Defogging
Digital Noise Reduction	2D + 3D DNR
Privacy Mask	20 configurable 3D privacy masks
Text Overlay	Yes
On-Screen Graphics	Yes

Built-in Analytics	Basic Face Detection, Object Based Motion Detection, Tampering Detection, Shock Detection, PTZ Auto Tracking, Object Line Crossing Detection, Object Enter Area Detection, Missing Object Detection, Unattended Object Detection, Object Loitering Detection
Server-based Analytics	Object Line Counting, People Counting, Face Detection, Object Based Motion Detection, Tamper, Object Line Crossing Detection, Object Enter Area Detection, Missing Object Detection, Unattended Object Detection, Smoke Detection, Heat Map, Dwell Time, Direction Detection, Automatic License Plate Recognition, People Queue Detection, (Require PC-based or standalone IVS or ALPR Server. Contact ACTi support for recommendations on how to maximize analytical accuracy)
Image Orientation	Flip, Mirror
IVS performance	Certain algorithms may require more computing power, which may limit the number of algorithms that can be concurrently used in the camera. Please test the actual performance before using in a project.

## Audio

Audio Type	2-way, Line-in, Line-out
Audio Compression	8 kHz, 16 bit encoding, Mono, PCM, G.711

## Network

Network Protocol & Service	IPv4/v6, TCP, UDP, DHCP, PPPoE, HTTP, HTTPS, DNS, DDNS, NTP, RTP, RTSP, RTCP, SMTP, FTP, IGMP, ICMP, ARP, Bonjour, UPnP, QoS, SNMP, IEEE 802.1X
Ethernet Port	1 x RJ-45 pigtail connector
Security	IP address filtering, HTTPS encryption, Password protected user level, Anonymous login, IEEE 802.1X network access control

## Video Analytics

Analysis Source Type	Video
Metadata Accuracy	Standard

## Event

Event Trigger	Video motion detection (10 included and excluded polygons regions), External device through digital input, Sound detection, Intelligent event detection,
Event Response	Notify control center, Go to PTZ preset point or preset tour, Change camera settings, Command other devices, E-mail notification with snapshots, Play the audio file, Push notification to mobile device, Save video to local storage, Upload video to NVR server, Upload video or snapshot to FTP server, Activate external device through digital output

## Integration

Unified Solution	Fully compatible with ACTi software
Software Development Kit	Yes
GPS Position	Manual setting
ONVIF Compliant	Yes, Profile S, Profile G, Profile T, Profile Q
GB28181 Compliant	Yes
Web Browser	IE 11
Auto Firmware Upgrade	Yes

## Interface

Audio Interface	Cable with 3.5mm Phone Jack
Local Storage	MicroSDHC, MicroSDXC Memory Card Slot (card not included, up to 256GB)

Digital Input/Output	4/2
----------------------	-----

### General

Power Source	AC 24V, High PoE
Power Consumption	50 W (PoE, heater, fan and IR on), 62 W (AC, heater, fan and IR on)
Weight	3112g (6.86lb)
Dimensions	(Ø x H): 170mm x 260mm (6.69" x 10.23")
Environmental Casing	Weatherproof (IP66), Vandal proof metal casing (IK10), Built-in dehumidifier, Scratch-resistant and water-repellent lens glass
Bundled Accessories	High PoE injector (for USA) or Power Adapter (for other countries)
Mount Type	Gang Box, Pendant, Converter for NPT Standard Mounts, Wall Mount, Pole Mount, Corner Mount
Fan	Yes
Heater	Yes
Dehumidifier	Yes
Starting Temperature	-40°C ~ 55°C (-40°F ~ 131°F) within 30 minutes
Operating Temperature	-40°C ~ 55°C (-40°F ~ 131°F)
Operating Humidity	10% - 85% RH
Approvals	CE, FCC, BIS, IP66, NEMA 4X, IK10 (metal casing), UL Listed (UL 60950-1)
Warranty	3 Year(s) (1 year in continuous motion). For extended warranty offering, see <a href="http://www.acti.com/support/warranty">http://www.acti.com/support/warranty</a>

### ▶ Photo Indication



- 1 Power LED
- 2 Reset Button
- 3 Memory Card Slot
- 4 Audio Output
- 5 Audio Input
- 6 Digital Input/Output
- 7 AC 24V Power Input
- 8 Ethernet Port



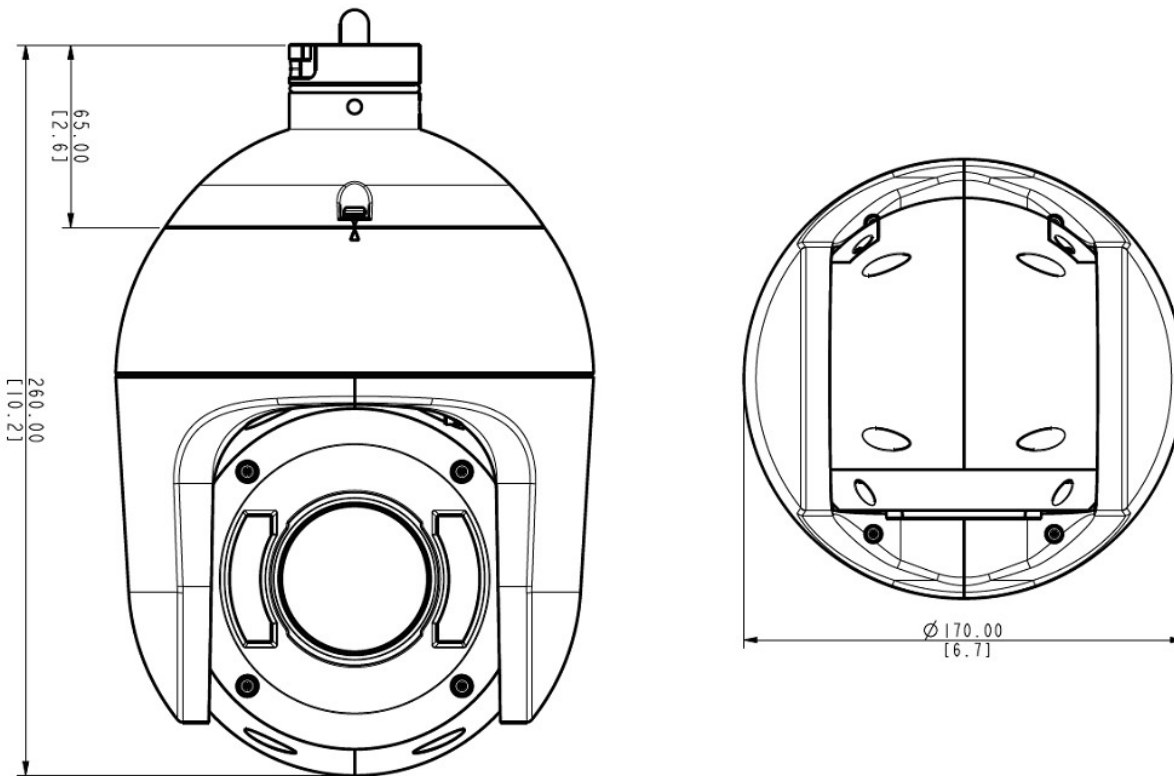









### ▶ Dimension Diagram



Unit: mm [inch]

## ▶ Related Products

### Mounting Accessories - Camera Mount



PMAX-0102		Straight Tube
PMAX-0103		Straight Tube with Bracket
PMAX-0104		Extension Tube
PMAX-0302		Gooseneck with Bracket
PMAX-0303		Gooseneck
PMAX-0312		PTZ Wall Mount for Outdoor PTZ / Speed Dome (except KCM-8211 & TCM-6630)
PMAX-0402		Corner Mount
PMAX-0503		Pole Mount (for PMAX-0102, PMAX-0312, PMAX-0313, PMAX-0314, PMAX-0702, PMAX-1106, PMAX-1107), supports 5.25" to 8.5" Poles
PMAX-0505		Pole Mount (for B4x, B41x, E44, E45, E46, E48, E44A, E45A, E46A, E41x, I4x, PMAX-0312, PMAX-0313, PMAX-0314, PMAX-0330), supports 2" to 3" Poles
PMAX-0702		Junction Box for PTZ and Dome Cameras
PMAX-0807		Gangbox Converter (for PMAX-0102, PMAX-0312, PMAX-0313, PMAX-0314, PMAX-0321), supports Two-Gang Boxes
PMAX-0808		Converter Ring, 1.5" NPT for Third-Party Mounting Accessories

**Note:** Some mounting accessories may need additional accessories for installation. Please check [www.acti.com/mountingselector](http://www.acti.com/mountingselector) for more information.

### Power Supply Accessories - Power Adapter

PPBX-0008		Power Adapter AC 100~240V, with universal connectors for PLED-0203~PLED-0205
-----------	---	--

### Power Supply Accessories - PoE Injector

PPOE-0102		High PoE Injector IEEE 802.3at compliant, AC 100~240V, with universal connectors (for I93~I910, KCM-8211)
PPOE-0103		High PoE Injector, Single-port, 60W Gigabit Midspan, 4-Pairs, 802.3at Compliant, AC 100~240V, with universal connectors (for, I93~I910, I915, B915~B917, B922, B928, B945, B949, A950)

### Network & Storage Peripherals - Data Switch

PPSW-0100		PLANET FGSD-910HP 8-Port 802.3at PoE Switch (PoE Budget 120W)
-----------	---	---

PPSW-0101  PLANET GS-4210-8P2T2S 8-Port Gigabit 802.3at Managed PoE Switch (PoE Budget 240W)

PPSW-0102  PLANET FGSD-1011HP 8-Port 802.3at PoE Switch (PoE Budget 120W)

PPSW-1101  PLANET GS-4210-24PL4C 24-Port Gigabit 802.3at Managed PoE Switch (PoE Budget 440W)

PPSW-2101  4-Port 802.3at PoE Switch (PoE Budget 62W)

PPSW-3100  PLANET FGSW-1816HPS 16-Port 802.3at PoE Switch (PoE Budget 220W)

## Extenders - PoE Extender

PPEX-0100  Veracity OUTREACH Max Power over Ethernet (PoE) Extender

## Extenders - PoE over Coaxial Extender Kit

PPOC-0100  Planet LRP-101C-KIT Power over Coax Adapter Kit

## Audio Devices - Microphone

PMIC-0100  Active Microphone Omnidirectional for all Cameras with Line-in Audio

## Illuminators - IR LED Illuminator

PLED-0200  SPINLUX (SL-A2IRXX10-24CL) IR Illuminator 10° Angle with 120 m approx. range

PLED-0201  SPINLUX (SL-A2IRXX25-24CL) IR Illuminator 25° Angle with 50 m approx. range

PLED-0202  SPINLUX (SL-A2IRXX35-24CL) IR Illuminator 35° Angle with 25 m approx. range

## Installation Support - Camera Installation Kit

PMON-1001-010  Camera Installation Kit for use with iOS Device with belt bag, battery and charger (US, AC 110~240V)

PMON-1001-011  Camera Installation Kit for use with iOS Device with belt bag, battery and charger (Europe, AC 110~240V)

PMON-2000  Camera Installation Kit