

ConteralP® Bullet EX Megapixel Camera

5 Megapixel (MP) H.265/H.264 All-in-One Motorized P-Iris Lens True Day/Night Indoor/Outdoor Bullet-Style IP Camera with SNAPstream+™ (Smart Noise Adaptation and Processing), Enhanced WDR™ (Wide Dynamic Range), NightView™, Smart IR, and Video Analytics

H.265



The ConteralP® Bullet EX outdoor-ready megapixel camera features 5-megapixel (MP) resolution for optimum performance. The ConteralP Bullet EX combines a day/night mechanical IR cut filter with an integrated motorized 2.7–12mm varifocal remote focus and zoom precision iris (P-iris) lens. The ConteralP Bullet EX is ONVIF (Open Network Video Interface Forum) Profile S, G, and T compliant, providing interoperability between network video products regardless of manufacturer.













The inclusion of on camera video analytics gives the ConteralP Bullet EX the ability to increase situational awareness and gather data for business intelligence. Alarm conditions can be setup to alert security for observed behaviors. Several of the analytic behaviors can also be used for business intelligence data gathering, such as the loitering behavior for tracking dwell time in retail environments.

Regardless of the time of day, the ConteralP Bullet EX is prepared for any lighting condition. Enhanced WDR™ (wide dynamic range) at 120dB provides the best visual balance to shaded and bright light

conditions, NightView™ offers strong low-light sensitivity for capturing details in extremely poor-lit scenes, and built-in Smart IR LED illumination automatically adjusts output in response to the distance of an object in view to prevent over-exposure when the object is very close to the camera.

AV Costar™ was the first to bring H.264 to the mainstream market and recently developed SNAPstream™ (Smart Noise Adaptation and Processing) technology for reducing bandwidth without impacting image quality. Today we are proud to offer our next generation H.265 with SNAPstream+™ smart codec capable of delivering high quality video while saving over 50% of the data rate to reduce or prevent strain on the network.

The microSD card slot supports up to 256GB of storage capacity for convenient onboard storage. The camera's power can be supplied via a Power-over-Ethernet (PoE - IEEE 802.3af) compliant network cable connection. The ConteralP Bullet EX is IP66 rated for both indoor and outdoor applications. All models feature an impact resistant cast-aluminum housing capable of withstanding the equivalent of 55 kg (120 lbs) of force.

												
Integrated Motorized Lens with Remote Focus and Zoom	P-Iris Control for Best Depth of Field and Image Clarity	SNAPstream+™ Technology	NightView™	Enhanced WDR™ Wide Dynamic Range	Smart IR LEDs	True Day/Night with IR Cut Filter	CorridorView™ with 90° Image Flip	Tri-Encoder H.265/H.264/MJPEG	SDXC Card Slot	All-in-One Bullet-Style Solution with Integrated Lens	Advanced Video Analytics	Impact / Weather Resistant IK-10 and IP66 Rated

Series Features

- 5MP Resolution
- Advanced Video Analytics
- 2.7–12mm Integrated Lens
- SNAPstream+™ Capability to Reduce Bandwidth without Impacting Image Quality
- NightView™ for Strong Low Light Performance
- True Day/Night Functionality with Mechanical IR Cut Filter
- Enhanced WDR up to 120dB at Full Resolution: See Clearly in Shaded and Bright Light Conditions Simultaneously
- CorridorView™ Allows 90° Image Rotation for Better Coverage in Hallways and Corridors
- Privacy Mask, Motion Detection, Bit Rate Control, Multi-Streaming, Multicasting, Forensic Zooming, and Scaling
- On-Screen Display (OSD)
- Defog Technology
- Triple Encoder: H.265/H.264/MJPEG
- Network Protocols Include SNMP, HTTPS, IPv6, 802.1x, DHCP, and More
- All-in-One H.265/H.264 PoE Solution
- Smart IR Illumination with Variable Illumination Ensures that IR Light is Evenly Disbursed up to 100ft (30m) for Scenes with Low or No Ambient Light
- Audio In / Out
- MicroSDXC Card Slot for Onboard Storage
- Outdoor Rated IP66 and IK-10 Impact-Resistant Housing
- Easily Adjustable 3-Axis Wall Mount

Camera Imaging Specifications

Model		AV5426PMIR-S
Image Sensor		5MP CMOS Progressive Sensor
Optical Format		1/2.9"
Minimum Illumination	Color (Day Mode)	0.1 Lux
	B/W (Night Mode)	0.01 Lux
Full FOV Resolution		2592 H x 1944 V
Scaling (See Scaling Resolutions Below)		Yes
IR Illumination		Yes
Dynamic Range		120dB
Frame Rates¹	Single Stream	Up to 30fps (5MP) ²
	Multi-Stream	Up to 15fps (5MP) ² + 10fps (5MP) ² Up to 30fps (1080p) ² + 30fps (720p) ² + 30fps (VGA) ²
Lens	Fixed Iris	2.7-12mm, F1.3, H-FOV = 24°-81°, V-FOV = 18°-57°, P-Iris

Programmability

Optics	Remote focus/zoom, P-iris lens
Low-Light Performance	NightView™ technology
	Smart IR
Programmable Shutter Speed	Auto/manual 0.1ms ~ 500ms
Motion Detection	Real-time, 1024 detection zones
Privacy Masking	Unlimited
Backlight Compensation	Auto
White Balance Mode	Auto/manual
Gain Control	Auto
Flicker Control¹	5Hz-255Hz adjustable
Image Rotation³	CorridorView™ (90°, 180°, and 270° image rotation) + mirror
Scaling	2592x1944, 2048x1536, 1920x1080, 1296x972, 1280x720, 640x480, 640x360, 320x240
Wide Dynamic Range	Adjustment between WDR and LDR modes
Efficiency	SNAPstream+™ (Smart Noise Adaptation and Processing)
	Bit rate and bandwidth limitation control
Defog	Supported
Miscellaneous	Programmable brightness, contrast, sharpness, saturation, hue
	Electronic pan, tilt, zoom (PTZ)
Password	16-digit ASCII character password
On-Screen Display (OSD)	Time/date/camera name/custom text
Basic Video Analytics	Motion Detection
	Camera Tamper
Advanced Video Analytics⁴	Intrusion Detection
	Line Crossing
	Loitering
Optional Advanced Video Analytics⁴	Object Classification (Person/Vehicle) ⁵
	Object Left/Removed ⁵
	People/Vehicle Counting ⁵

- 30 frames per second (FPS) maximum with H.264 and H.265 compression at 60 hertz (Hz), up to 25fps maximum at 50Hz
- Max FPS with Enhanced WDR™ turned on will be up to 50% of listed FPS
- Limited to 180° rotation with video analytics enabled
- Analytics are not designed for heavy traffic locations such as roads and intersections
- Requires Optional Advanced Video Analytic License

Data Transmission

Compression Type	H.265/H.264 (MPEG-4, Part 10)/Motion JPEG
Bit Rate Control	64K-8000K
Smart Codec	Smart GOP/Smart ROI
Transmission Protocols	SNMP, HTTP, HTTPS, IPv6, IPv4, SSL, TCP/IP, UPnP, UDP, RTCP, RTSP, RTP, SMTP, NTP, DHCP, FTP, 802.1x, Zero Configure
	10/100Base-T Ethernet network interface, RJ45
Multi-Streaming	2 x H.265/H.264 stream, 1 x M-JPEG stream
Users	Live viewing/Administrator for up to 10 clients

Event Management

Event Trigger	Motion detection, video analytics, alarm in
Notifications	Send/record message via e-mail/FTP/NAS/SD card, record JPG/mp4

Compliance

Industry Standard	ONVIF Profile S, G, T conformant
Listings	UL (CB) UL60950-1, E489591
FCC Compliance	47 CFR 15 Class A
Environmental	RoHS, REACH, WEEE
Markings	CE: EN55032 Class A, EN55024, EN61000-3-2, EN61000-3-3, EN60950
Mechanical	IK-10 (EN62262), IP66 (EN60529)

Environmental

Operating Temperature	-20°C (-4°F) to +50°C (122°F)
Humidity	0% to 90% (non-condensing)
Storage Temperature	-40°C (-40°F) to +60°C (140°F)

General Electrical

Alarm Input/Output	1 input (wet contact)/1 output (wet contact)
Power Over Ethernet	PoE IEEE 802.3af, Class 3
	Total PoE solution (no external power requirement)
Auxiliary Power	12-48V DC, 24V AC
Power Consumption	8.9W PoE max

IR Illuminator

LEDs	48pcs, Smart IR
Projection Distance	100ft (30m) max

Audio Electrical

Streaming	Two-way
Compression	G.711 PCM 8 kHz
Input/Output	Line in ⁶ / Line output

Mechanical

Casing	Die-cast aluminum cylindrical (bullet-style) housing	
	IP66 weather proof standard	
	Impact resistant, IK-10 rated	
Mount	Easily adjustable 3-axis with 360° pan, 90° tilt and 360° z-axis	
Dimensions <small>(See Dimensions)</small>	Unit	4.7" H (119mm) x 4.7" W (119mm) x 9.3" D (236mm)
	Packaged	5.6" H (142mm) x 5.6" W (142mm) x 11" L (280mm)
Weight	Unit	2.72lbs (1.23kg)
	Packaged	3.31lbs (1.5kg)
On Board Storage	MicroSDXC slot up to 256GB (card not included)	
Body Color	AV Costar White (Pantone® Cool Gray 1C)	

Dimensions

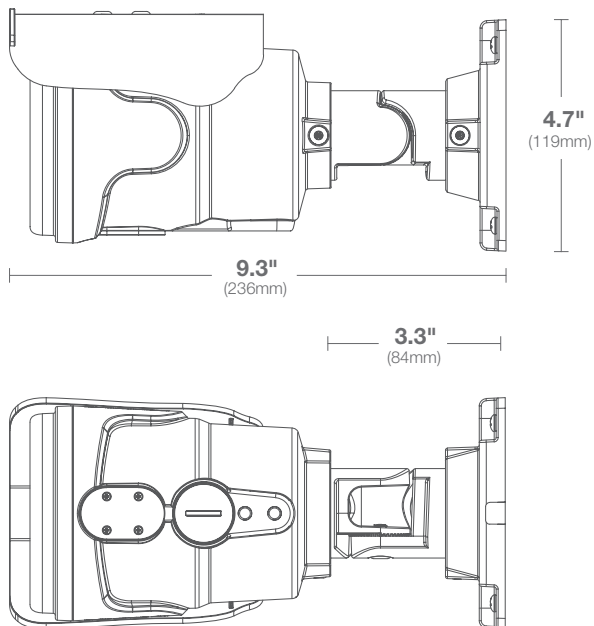

6. Requires Amplification

See Next Page for Ordering Information



Model Numbers

5MP	AV5426PMIR-S	WDR
------------	--------------	------------

Optional Advanced Video Analytic License

AV-CADVA1	Enables Optional Advanced Video Analytic Behaviors on ConteraIP EX Cameras
------------------	--

Accessories

AV-CRMA-W	Corner Mount Adapter (AV Costar White)
AV-EBAS-W	Square Electrical Box Adapter Plate (AV Costar White)
AV-JBA-W	Standard Junction Box (AV Costar White)
AV-PMA-W	Pole Mount Adapter (AV Costar White)

Configurations



Bullet

Create Your Model (Example: AV5426PMIR-S)

Megapixel Resolution	Generation	Body Type	Compression	Lens	Infrared	Onboard Storage
----------------------	------------	-----------	-------------	------	----------	-----------------

